

AXIS P33 Network Camera Series

Fixed domes for any environment with remote focus and zoom.



- > Superb video quality including HDTV 1080p
- > Multiple H.264 video streams
- > Remote focus and zoom
- > Outdoor ready
- > Digital PTZ and multi-view streaming
- > P-Iris control

AXIS P33 Network Cameras constitute a series of indoor and outdoor-ready fixed domes. These cameras are ideal for unobtrusive video surveillance in exposed areas such as airports, subways, retail stores, schools and university campuses.

AXIS P33 Series offers models from SVGA resolution up to 3 megapixel, including support for HDTV 720p and 1080p in compliance with the SMPTE standard in resolution, color representation and frame rate. All models provide day and night functionality with removable infrared-cut filter for increased light sensitivity.

The remote focus feature allows for convenient installation eliminating the need for hands-on focusing at the camera, and the remote zoom and pixel counter features ensure that the camera's angle of view is optimized for the scene and pixel resolution.

AXIS P33 Series provides multiple, individually configurable H.264 and Motion JPEG video streams. All AXIS P33 cameras offer digital pan/tilt/zoom, and the 3-megapixel AXIS P3346 models additionally provide multi-view streaming.

AXIS P3346 cameras offer the unique and revolutionary P-Iris control, which allows the cameras to precisely control the iris position to optimize depth of field and lens resolution for optimal image sharpness.

AXIS P33 Series ranges from indoor cameras to vandal-resistant outdoor models, supplied by standard Power over Ethernet (IEEE 802.3af). Weather-proof models operate in temperatures from -40 °C to 55 °C (-40 °F to 131 °F).



Fixed domes designed for efficient installation – indoors or outdoors

AXIS P33 Series is the perfect choice for a wide range of demanding video applications in outdoor and indoor environments. AXIS P33 Network Cameras are designed for professional video surveillance with easy and reliable installation in focus.



Outdoor-ready installation for extreme temperatures

The outdoor models of AXIS P33 Series are specially designed for reliable, vandal-resistant and weather-proof installation, with pre-installed heater and fan, and an integrated dehumidifying membrane eliminating any humidity caught in the camera casing during installation. These cameras come with a 5 m (16 ft.) Ethernet cable with a pre-mounted, specially designed gasket, enabling flush wall mounting and requiring no additional sealant. A weather shield is also included for effective protection against reflections from sunlight, or build-ups of rain or snow.

camera models include a smoked transparent cover as an alternative to the clear cover, for additional flexibility.

Easy installation with remote focus and zoom

AXIS P33 Network Cameras offer unique installation capabilities with remote focus and zoom. The remote focus feature enables convenient focusing over the network, eliminating the need for hands-on fine-tuning at the camera. The remote zoom functionality ensures that the viewing angle is optimized for the area to be monitored.



Unique pixel counter feature

Mounting options

AXIS P33 Series offers a wide range of optional kits for indoor and outdoor installations, for example, for mounting on a wall, pole or corner. The IP51-rated drop ceiling mount kit protects the camera from condensation and dust that may exist in the plenum space above the drop ceiling. Both indoor and outdoor

Unique pixel counter feature

The unique pixel counter offered in Axis cameras allows the installer to easily verify that the camera installation fulfills any regulatory or specific customer requirements, for example, calculating the pixel resolution of the face of a person passing a doorway monitored by the camera.



AXIS P3343-VE /P3344-VE
Weight: 1.6 kg (3.5 lb.) with weather shield

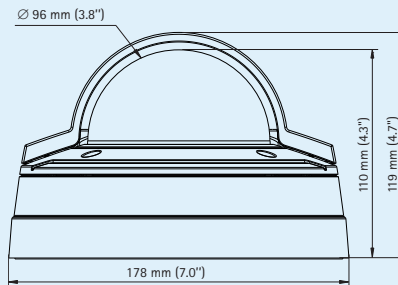

AXIS P3346-VE
Weight: 1.7 kg (3.7 lb.) with weather shield

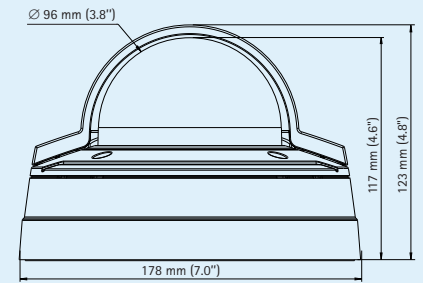

AXIS P3343-V/P3344-V
AXIS P3343/P3344 weight: 450 g (1.0 lb.)
AXIS P3343-V/P3344-V weight: 660 g (1.5 lb.)

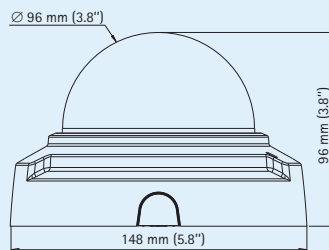

AXIS P3346-V
AXIS P3346 weight: 490 g (1.1 lb.)
AXIS P3346-V weight: 700 g (1.6 lb.)

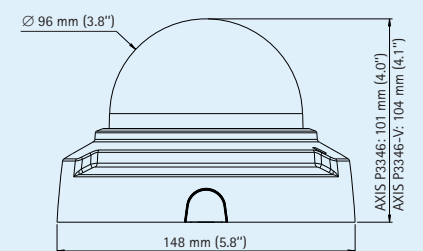

AXIS P3343-VE/P3344-VE/P3346-VE

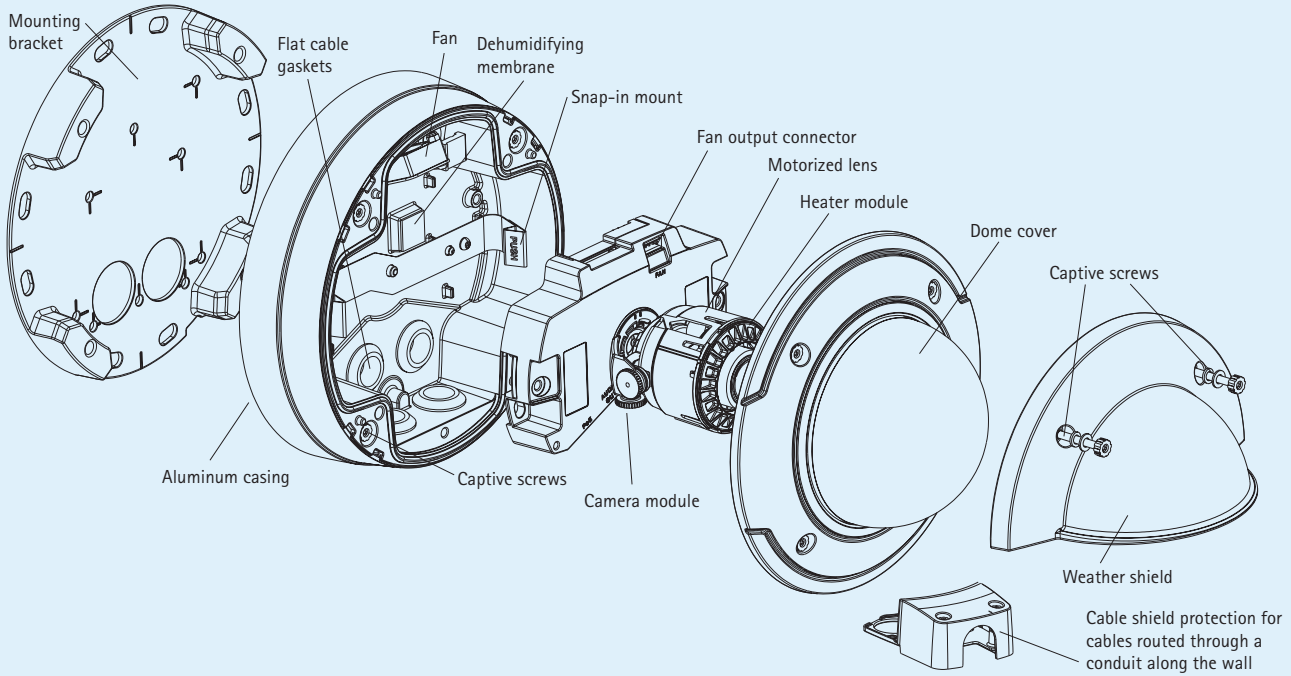

AXIS P3343-V/P3344-V/P3346-V

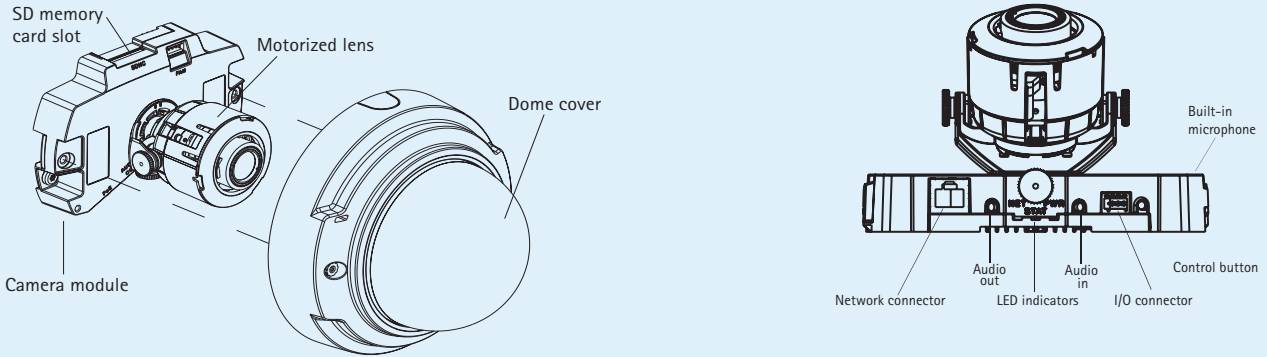

Optional accessories for outdoor models

Pendant adapter kit including weather shield



AXIS T91A Brackets



Wall

Corner

I/O audio cable, 5 m (16 ft.)



AXIS T90A Illuminators



Optional accessories for indoor models

Pendant adapter kit

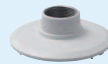

AXIS T91A Brackets



Ceiling

Wall

Mounting bracket



IP51-rated drop-ceiling mount kit with transparent or smoked cover



For information on AXIS Camera Station and video management software from Axis' Application Development Partners, see www.axis.com/products/video/software/

Technical Specifications – AXIS P33 Network Camera Series

Camera		Network	
Models	<p>AXIS P3343: SVGA, tamper-resistant, indoor</p> <p>AXIS P3343-V: SVGA, vandal-resistant, indoor</p> <p>AXIS P3343-VE: SVGA, vandal-resistant, outdoor</p> <p>AXIS P3344: 1MP/HDTV 720p, tamper-resistant, indoor</p> <p>AXIS P3344-V: 1MP/HDTV 720p, vandal-resistant, indoor</p> <p>AXIS P3344-VE: 1MP/HDTV 720p, vandal-resistant, outdoor</p> <p>AXIS P3346: 3MP/HDTV 1080p, tamper-resistant, indoor</p> <p>AXIS P3346-V: 3MP/HDTV 1080p, vandal-resistant, indoor</p> <p>AXIS P3346-VE: 3MP/HDTV 1080p, vandal-resistant, outdoor</p> <p>6mm or 12mm as suffix specifies lens option</p> <p>Note: AXIS P3301-V and AXIS P3304-V are not part of AXIS P33 Series</p>	Security	Password protection, IP address filtering, digest authentication, user access log, IEEE 802.1X** network access control, HTTPS** encryption
Image sensor	<p>AXIS P3343/-V/-VE and AXIS P3344/-V/-VE: Progressive scan RGB CMOS 1/4"</p> <p>AXIS P3346/-V/-VE: Progressive scan RGB CMOS 1/3" (effective)</p>	Supported protocols	IPv4/v6, HTTP, HTTPS**, QoS Layer 3 DiffServ, FTP, SMTP, Bonjour, UPnP, SNMPv1/v2c/v3(MIB-II), DNS, DynDNS, NTP, RTSP, RTP, TCP, UDP, IGMP, RTCP, ICMP, DHCP, ARP, SOCKS
Lens	<p>Varifocal with remote zoom and focus, IR corrected, megapixel resolution</p> <p>AXIS P3343/-V/-VE 6 mm: 72°-34° view*, F1.2, DC-iris</p> <p>AXIS P3343/-V/-VE 12 mm: 54°-17° view*, F1.4, DC-iris</p> <p>AXIS P3344/-V/-VE 6 mm: 87°-40° view*, F1.4, DC-iris</p> <p>AXIS P3344/-V/-VE 12 mm: 70°-20° view*, F1.6, DC-iris</p> <p>AXIS P3346/-V/-VE: 9 mm: 84°-30° view*, F1.2, P-Iris</p> <p>*horizontal angle of view</p>	System integration	
Day and night	Automatically removable infrared-cut filter	Application Programming Interface	Open API for software integration, including the ONVIF specification available at www.onvif.org , as well as VAPIX® and AXIS Camera Application Platform from Axis Communications, specifications available at www.axis.com Support for AXIS Video Hosting System (AVHS) with One-Click Camera connection
Minimum illumination	<p>AXIS P3343/-V/-VE 6 mm: Color: 0.2 lux, F1.2, B/W: 0.04 lux, F1.2</p> <p>AXIS P3343/-V/-VE 12 mm: Color: 0.3 lux, F1.4, B/W: 0.05 lux, F1.4</p> <p>AXIS P3344/-V/-VE 6 mm: Color: 0.3 lux, F1.4, B/W: 0.05 lux, F1.4</p> <p>AXIS P3344/-V/-VE 12 mm: Color: 0.4 lux, F1.6, B/W: 0.06 lux, F1.6</p> <p>AXIS P3346/-V/-VE: Color: 0.5 lux, F1.2, B/W: 0.08 lux, F1.2</p>	Intelligent video	Video motion detection, active tampering alarm, audio detection Support for AXIS Camera Application Platform enabling installation of additional applications
Shutter time	<p>AXIS P3343/-V/-VE and AXIS P3344/-V/-VE: 1/25000 s to 1/6 s</p> <p>AXIS P3346/-V/-VE: 1/35500 s to 1/6 s</p>	Alarm triggers	Intelligent video, external input
Camera angle adjustment	<p>AXIS P3343/-V/-VE and AXIS P3344/-V/-VE: Pan 360°, tilt 170°, rotation 340°</p> <p>AXIS P3346/-V/-VE: Pan 360°, tilt 160°, rotation 340°</p>	Alarm events	File upload via FTP, HTTP and email Notification via email, HTTP and TCP External output activation Video and audio recording to local storage Pre- and post-alarm video buffering
Video		Installation aids in software	Remote zoom, remote focus, pixel counter
Video compression	H.264 (MPEG-4 Part 10/AVC) Motion JPEG	General	
Resolutions	<p>AXIS P3343/-V/-VE: 800x600 to 160x90</p> <p>AXIS P3344/-V/-VE: 1280x800 to 160x90*</p> <p>AXIS P3346/-V/-VE: 2048x1536 to 160x90</p> <p>*1440x900 (1.3 MP) scaled resolution available via VAPIX®</p>	Casing	Polycarbonate transparent cover Aluminum inner camera module with encapsulated electronics Color: white NCS S 1002-B AXIS P3343/P3344/P3346: Tamper-resistant polycarbonate casing AXIS P3343-V/P3344-V: 1000 kg (2200 lb.) impact-resistant aluminum casing AXIS P3346-V: IK10 impact-resistant aluminum casing AXIS P3343-VE/P3344-VE: IP66- and NEMA 4X-rated, 1000 kg (2200 lb.) impact-resistant aluminum casing with integrated dehumidifying membrane AXIS P3346-VE: IP66- and NEMA 4X-rated, IK10 impact-resistant aluminum casing with integrated dehumidifying membrane
Frame rate H.264	<p>AXIS P3343/-V/-VE and AXIS P3344/-V/-VE: 30 fps in all resolutions</p> <p>AXIS P3346/-V/-VE: 3MP mode: 20 fps in all resolutions, HDTV 1080p (1920x1080) and 2MP 4:3 (1600x1200) modes: 30 fps in all resolutions</p>	Processor and memory	<p>AXIS P3343/-V/-VE and AXIS P3344/-V/-VE: ARTPEC-3, 128 MB RAM, 128 MB Flash</p> <p>AXIS P3346/-V/-VE: ARTPEC-3, 256 MB RAM, 128 MB Flash</p>
Frame rate Motion JPEG	<p>AXIS P3343/-V/-VE and AXIS P3344/-V/-VE: 30 fps in all resolutions</p> <p>AXIS P3346/-V/-VE: 3MP mode: 20 fps in all resolutions, HDTV 1080p (1920x1080) and 2MP 4:3 (1600x1200) modes: 30 fps in all resolutions</p>	Power	Power over Ethernet IEEE 802.3af AXIS P3343-V, AXIS P3344-V and AXIS P3346-V: Class 2 AXIS P3343-VE/P3344-VE/P3346-VE: Class 3
Video streaming	<p>Multiple, individually configurable streams in H.264 and Motion JPEG</p> <p>Controllable frame rate and bandwidth</p> <p>VBR/CBR H.264</p>	Connectors	RJ-45 10BASE-T/100BASE-TX PoE Terminal block for 1 alarm input and 1 output 3.5 mm mic/line in, 3.5 mm line out
Multi-view streaming	<p>AXIS P3346/-V/-VE: Up to 8 individually cropped out view areas.</p> <p>When streaming 5 view areas in VGA resolution, the frame rate is 20 fps per stream in H.264/Motion JPEG (3 MP capture mode)</p> <p>Digital PTZ, preset positions, guard tour</p>	Local storage	SD/SDHC memory card slot (card not included)
Image settings	<p>Compression, color, brightness, sharpness, contrast, white balance, exposure control, exposure zones, backlight compensation, wide dynamic range - dynamic contrast, fine tuning of behavior at low light</p> <p>Rotation: 0°, 90°, 180°, 270°, including Corridor Format™</p> <p>Text and image overlay, privacy mask, mirroring of images</p>	Operating conditions	<p>AXIS P3343-V, AXIS P3344-V and AXIS P3346-V: 0 °C to 50 °C (32 °F to 122 °F), humidity 15 - 85% RH (non-condensing)</p> <p>AXIS P3343-VE/P3344-VE/P3346-VE: -40 °C to 55 °C (-40 °F to 131 °F), humidity 15 - 100% RH (condensing)</p>
Audio		Approvals	EN 55022 Class B, EN 61000-3-2, EN 61000-3-3, EN 55024, FCC Part 15 Subpart B Class B, ICES-003 Class B, VCCI Class B, C-tick AS/NZS CISPR 22, EN 60950-1 AXIS P3346-V: IEC 62262 IK10 AXIS P3343-VE/P3344-VE: IEC 60529 IP66, NEMA 250 Type 4X AXIS P3346-VE: IEC 60529 IP66, NEMA 250 Type 4X, IEC 62262 IK10
Audio streaming	Two-way	Included accessories	Mounting and connector kits, Installation Guide, CD with installation tools, recording software and User's Manual, Windows decoder 1-user license, smoked transparent cover AXIS P3343-VE/P3344-VE/P3346-VE: mounting bracket, weather shield, cable shield, 5 m (16 ft.) network cable with pre-mounted gasket
Audio compression	<p>AAC LC 8/16 kHz</p> <p>G.711 PCM 8 kHz</p> <p>G.726 ADPCM 8 kHz</p> <p>Configurable bit rate</p>		
Audio input/output	External microphone input or line input, line output AXIS P3343-V, AXIS P3344-V and AXIS P3346-V: Built-in microphone		

** This product includes software developed by the OpenSSL Project for use in the OpenSSL Toolkit. (www.openssl.org)

More information is available at www.axis.com