

**SAMSUNG**



## 37x/30x Network PTZ Camera **SNP-3370/3301** User Guide

Before installing and operating this product,  
please read this manual thoroughly.

English

# Contents

User Guidelines .....	4
Preface .....	5
Product Warranty and Limited Liability .....	5
Cautions & Warnings .....	6
<b>Ch 1. Product Introduction .....</b>	<b>10</b>
1.1. Introduction .....	10
1.2. Features .....	10
<b>Ch 2. Part Names &amp; Functions .....</b>	<b>12</b>
2.1. Package Contents .....	12
2.2. Camera Body .....	14
2.3. Camera Wiring Interface Board (Sold Separately) .....	15
<b>Ch 3. Installing Camera &amp; Network Setup .....</b>	<b>16</b>
3.1. PTZ Dome Camera and Accessory Wiring Diagrams .....	16
3.2. DIP Switch Settings .....	17
3.3. Preparing Adapter and Cable .....	25
3.4. Connecting Monitor .....	26
3.5. Preparing & Installing Camera Bracket .....	27
3.6. Ceiling Installation Example .....	28
3.7. Network Configuration & Connection via Website .....	30
<b>Ch 4. Using Web Viewer .....</b>	<b>35</b>
4.1. Using Web Viewer .....	35
4.1.1. Login .....	35
4.1.2. Monitoring Screen .....	36
4.2. Administrator Page .....	41
4.2.1. Video Setup .....	41
4.2.1.1. Video / Audio .....	41
4.2.1.2. Streaming .....	43
4.2.1.3. Motion Detection .....	49
4.2.1.4. Video Analytics .....	50
4.2.1.5. Privacy .....	51
4.2.1.6. Camera .....	53
4.2.1.7. Record .....	59
4.2.1.8. Replay / Backup .....	60
4.2.2. PTZ Page .....	61
4.2.2.1. Swing .....	63

4.2.2.2. Group .....	64
4.2.2.3. Tour .....	65
4.2.2.4. Trace & Auto Run .....	66
4.2.3. Config Page .....	67
4.2.3.1. Network .....	67
4.2.3.2. IP Filtering .....	75
4.2.3.3. Alarm Sensor .....	76
4.2.3.4. E-mail-FTP (Alarm) .....	78
4.2.4. System .....	80
4.2.4.1. Product Info .....	80
4.2.4.2. User .....	81
4.2.4.3. Time .....	83
4.2.4.4. Log Message .....	84
4.2.4.5. Upgrade .....	85
<b>Ch 5. Troubleshooting .....</b>	<b>86</b>
<b>PC Requirements .....</b>	<b>88</b>
<b>Specifications .....</b>	<b>89</b>
<b>Dimension .....</b>	<b>91</b>

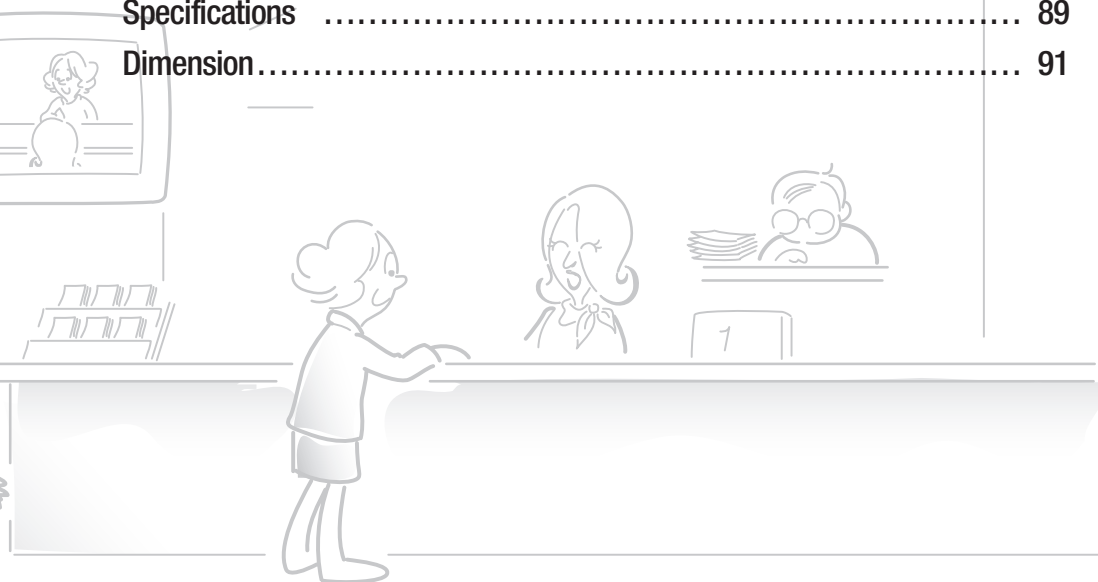

**Notes** For more detailed instructions on using the SVM-S1 program, please refer to the enclosed SVM-S1 Quick Guide and the instruction file in the CD.

# iPOLiS

**iPOLiS** is a brand integrated into Samsung's network products, it stands for a convenient world (Polis) made safe (Police) through Samsung's superior network performance (Internet Protocol). iPOLiS network cameras and servers are our advanced security systems providing versatile network options by default, including an Ethernet interface for easy internet connection, high-quality image transfer options using H.264, MPEG-4, M-JPEG a Web Viewer, two-way audio, and remote control capacity.

## FCC Compliance Statement

**NOTE :** This equipment has been tested and found to comply with the limits for a Class A digital device, pursuant to part 15 of the FCC Rules. These limits are designed to provide reasonable protection against harmful interference when the equipment is operated in a commercial environment. This equipment generates, uses, and can radiate radio frequency energy and, if not installed and used in accordance with the instruction manual, may cause harmful interference to radio communications. Operation of this equipment in a residential area is likely to cause harmful interference in which cause the user will be required to correct the interference at his own expense.

## Correct Disposal of This Product

*(Waste Electrical & Electronic Equipment)*



(Applicable in the European Union and other European countries with separate collection systems) This marking on the product, accessories or literature indicates that the product and its electronic accessories (e.g. charger, headset, USB cable) should not be disposed of with other household waste at the end of their working life. To prevent possible harm to the environment or human health from uncontrolled waste disposal, please separate these items from other types of waste and recycle them responsibly to promote the sustainable reuse of material resources. Household users should contact either the retailer where they purchased this product, or their local government office, for details of where and how they can take these items for environmentally safe recycling. Business users should contact their supplier and check the terms and conditions of the purchase contract. This product and its electronic accessories should not be mixed with other commercial wastes for disposal.

## Correct Disposal of Batteries in this Product

*(Applicable in the European Union and other European countries with separate battery return systems.)*



This marking on the battery, manual or packaging indicates that the batteries in this product should not be disposed of with other household waste at the end of their working life. Where marked, the chemical symbols Hg, Cd or Pb indicate that the battery contains mercury, cadmium or lead above the reference levels in EC Directive 2006/66. If batteries are not properly disposed of, these substances can cause harm to human health or the environment. To protect natural resources and to promote material reuse, please separate batteries from other types of waste and recycle them through your local, free battery return system.



Samsung Techwin cares for the environment at all product manufacturing stages, and is taking measures to provide customers with more environmentally friendly products.

The Eco mark represents Samsung Techwin's devotion to creating environmentally friendly products, and indicates that the product satisfies the EU RoHS Directive.

## ■ Preface

Thank you for purchasing this SNP-3370/3301 camera.

This user's manual describes how to use the high-resolution network camera. Also 'product' in this document indicates high-resolution network camera. The user who installs and operates the product shall be aware of this manual and other manuals referenced by this manual before the installation and operation and use it properly. Copyright law protects the manual, software and hardware explained here. All copying, reprinting and translating to other languages of part of or all of its contents without permission of Samsung Techwin Co., Ltd. are not allowed, except for fair use within the scope of copyright law.

## ■ Product Warranty and Limited Liability

The manufacturer of this product is not responsible for the sale of the product, nor does the manufacturer delegate such responsibility to a third party.

The product warranty does not cover accidents, negligence, abuse, or improper use for the item in whole or in any part. Additionally, the manufacturer does not provide warranty for any additional part or piece that was not supplied by the manufacturer.

The product warranty period is for 3 years from the purchase date. However, the warranty does not cover any of the following problems, and a nominal service fee will be charged if:

- Product has been improperly used or handled by user.
- Product has been disassembled and/or altered by user.
- Product has been damaged by connecting a power supply with improper specifications.
- Product has been damaged due to an "Act of God" (fire, flood, tsunami, natural disaster, etc.).
- To replace expendable components.
- Product is malfunctioning due to an unstable network connection.

**■ This instruction manual is based on the product installed with the firmware version at 1.0.0.**

## Cautions & Warnings

The following section contains vital information that helps protect the safety of the user and prevent property damage/loss. Please read it carefully for safe and proper use of your product.

- ※ If you have questions about the product, please contact your local vendor. Please note that no ancillary costs occurring during the service of your product (hiring a ladder car, for example) are covered by the warranty.
- ※ Please disconnect the plug from the outlet during electrical storms. (To avoid product damage and prevent fire.)
- ※ This product is a supplementary security device; the manufacturer will not be held liable for any damage to property, personal injury, and/or death caused by theft, fire, or natural disaster that may occur during the use of this product.

### Legend: Warning and Caution Symbols



This warning symbol indicates potential death, grave personal injury, and/or damage to property as consequences for failure to comply.



This caution symbol indicates damage to the equipment, installed programs, and/or contained data as consequences for failure to comply.



This symbol indicates an informative appendix to a certain section of this user's manual.

## Warning ⚡

**This product must be installed only by specially-trained personnel.**

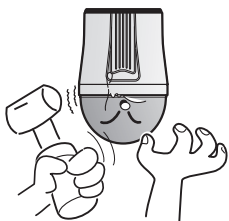

Installing this product requires experience and specialized skills; attempting to install the product by yourself exposes you to the risk of fire and/or electric shock. Please contact your vendor for installation.

**Stop using the product immediately if smoke or an unusual amount of heat is emanating from your camera.**

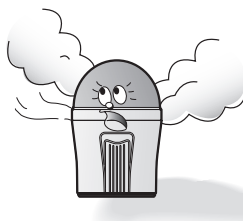

It may result in fire.

**Do not install the product in a damp area, or where it may be exposed to flammable liquids and/or gas.**



The product malfunctions, electric shock, and/or fire may occur.

**Do not install the product on a structurally unsound surface.**

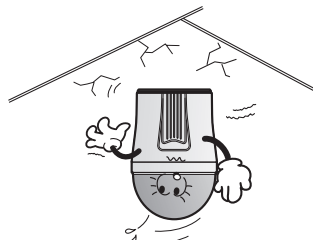

The product may become detached and fall.

**Do not handle the power plug with wet hands.**

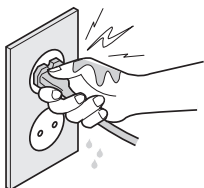

It may cause electric shock.

**Do not install the product where it may be exposed to rain, water, and/or radioactivity.**



Water may enter the product and cause malfunctions.

## Caution

Do not install the product in a location where it may be exposed to extreme heat or cold.



Using the product in extremely hot (over 50°) or extremely cold (under -10°) environments may degrade picture quality and/or cause product malfunctions.

When using the product in hot areas, be sure to provide adequate ventilation for the product.

Do not drop the product, or subject it to strong shocks or vibration.



It may damage the product.

Do not touch the camera lens.



It is the most important component of your product. Avoid contaminating the lens with fingerprints or other pollutants.

Do not install the product in areas with flickering illumination.

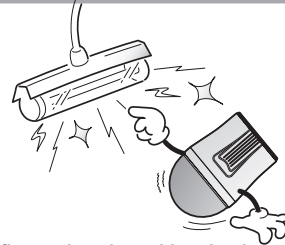

Severe fluctuations in ambient luminance, such as flickering of old fluorescent lights, may cause the product to malfunction.

Never point the camera directly at the sun, or other powerful sources of light.

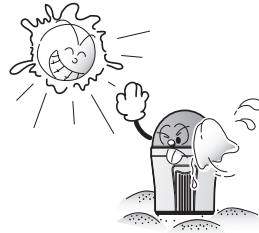

You may severely damage the charge-coupled device (CCD).

Do not disassemble the product or allow foreign objects to get into the product.

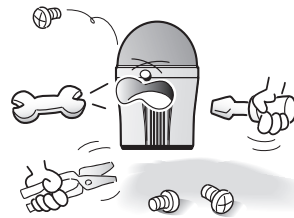

Product damage and/or fire may occur.

## Detailed Warnings and Cautions

- Avoid operating the camera for long durations under high temperatures and in high humidity. Excessive heat can shorten the lifespan of the camera components.  
Do not install or place the camera near any heat sources.
- Subjecting the dome cover to physical shock may damage the camera and cause water leakage into it.
- Do not place the camera facing direct sunlight or other intense light sources. Strong lights such as spotlights can cause distortions—blooming and smear—as well as discolorations on the screen by heating up the color filter of the camera. They also may cause reflections inside the camera, leading to operational malfunctions.
- Do not drop the camera or subject it to physical shock or vibration; this can cause serious damage to the camera.
- When installing the camera near a power line, make sure to keep at least 1 meter distance from the power line, or earth an additional metal pipe to separate the camera from the power source.
- This camera is for installation on a ceiling. Installing it on the ground or in a location that is not level may cause product malfunctions and shorten its lifespan.
- When installing it in an outdoor environment, use the outdoor housing.
- Avoid installing and operating the camera in the following places.
  - Places where the temperature exceeds the camera's recommended range. (Indoors: -10° ~ 50°, Outdoors: Refer to the housing manual)
  - Places where drastic temperature changes occur: e.g. Near an air conditioner.
  - Places that are exposed to steam, oil, and flammable substances: e.g. Inside a kitchen.
  - Places that are exposed to radioactivity, X-rays, strong electric waves, and electro-magnetic waves.
  - Places that are exposed to outdoor air contaminants: e.g. Dust and car exhaust.
  - Places where there is high humidity.
  - Places that are exposed to corrosive gas: e.g. Near the sea.
- Covers that are dusty or smeared decrease the picture and video quality. Clean the dome cover and camera lens on a regular basis.
- Remove the plastic wrap on the dome cover only after the camera installation is complete.
- This camera is not equipped with a power switch. Plug in the camera only after the installation is complete.
- The main unit has a large and a small door.  
A large door has a 24-pin connector and a small one has a 4-pin connector. Because these are not used for the product operation, do not connect cables to them. It may result in malfunction.



### Caution

- Risk of Explosion if Battery is replaced by an Incorrect Type.  
Dispose of Used Batteries According to the Instructions.(See 4 page)

# Chapter 1. Product Introduction

## 1.1. Introduction

The SNP-3370/3301 37x/30x PTZ network camera is based on H.264, MPEG-4 codec technology, which achieves both a high data compression rate and high image quality. This advanced network camera is capable of transferring high quality image data at a high frame rate and in real time over a network. It is easy to install and use; you only need a network cable to install and connect it to your network, and you can remote-control, monitor, command it online from anywhere, at anytime.

The SNP-3370/3301 37x/30x PTZ network camera is provided with our proprietary embedded software solutions (Embedded Web Server, Embedded Streaming Server, and Network Protocol) to guarantee optimal performance and stability through various internet-integrated services.

## 1.2. Features

### 37x/30x Zoom Lens with Autofocus Capacity

The built-in 37x/30x optical zoom lens with autofocus capacity is combined with a 12x digital zoom, providing a maximum of 444x/360x zoom.

### High Data Compression Rate

Based on the H.264, MPEG-4 high data compression rate, this camera has a comparatively high data transfer rate; images are transferred at a high frame rate over a network.

### Wide Range Auto Security Functions

- Individual Preset Mode  
To achieve optimum video quality, each preset can be saved with up to 7 different control options in the camera OSD.
- Image Hold  
When moving between presets, the camera can hold the image status, which helps the screen observer relieve visual fatigue.
- PTZ Trace  
Up to 4 custom network patterns can be saved and replayed.
- Auto Swing  
You can command the camera to perform the Pan or Tilt operation repeatedly between 2

locations.

- Group Monitoring  
The camera can monitor up to 255 preset locations at a time in the order that they are selected.
- Tour Search  
Using the Tour Search function calls up to 6 groups at a time to call and monitor the presets programmed into the groups.

### Smart P/T

The Pan and Tilt speed compensation option allows detailed manual control even when the camera zooms in on an object.

### Day & Night Technology

With its daytime & nighttime switch and Sens-Up functions based on the ICR (Infrared Cut filter Removal) method, the camera provides high-quality pictures regardless of whether it is day or night.

- ※ Sens-Up increases the CCD sensitivity by electrically extending the camera's exposure time.
- ※ Day & Night enables you to select between color and B/W modes depending on the lighting conditions.



### **Preset Position Saving and Loading**

Up to 255 preset positions can be set and loaded at any time.



### **Digital Flip**

Use the Digital Flip option in the webpage or Web Viewer to monitor an object moving under the camera. You can monitor it easily without inverting the screen from top to bottom or from left to right.



### **Area Zoom**

Area Zoom allows the operator to zoom in on a specific spot by drawing a box on the screen. This option is simple to use via the mouse. In the Area Zoom mode, PTZ operations can be controlled with a single mouse click.



### **Real-Time Multi-Channel Multi-Encoding**

This camera can encode images simultaneously at different resolutions (4CIF, CIF, QCIF) with two different codecs (H.264, MPEG-4, JPEG) and transfer them in real time.



### **SD Memory Card Slot for Local Storage**

SD memory cards can be used to store event data.



### **Privacy Protection**

You can mask up to 8 desired areas on the screen for privacy protection.



### **Supports RTSP, RTP/UDP, RTP/Multicast**



### **Alert Options**

The camera's motion detection is integrated with various alert options; you can set it up to transfer a still image via FTP or e-mail, or store the image to an SD memory card upon detecting movement.



### **Two-Way Audio**

Audio data can be transferred both ways in real time.



### **Supports RS-485**

This camera supports the RS 485/RS 422 long-distance communication protocols for remote control via our controller.



### **Supports Analog Output**

For enhanced installation convenience, this camera supports analog output.

## Chapter 2. Part Names & Functions

### 2.1. Package Contents

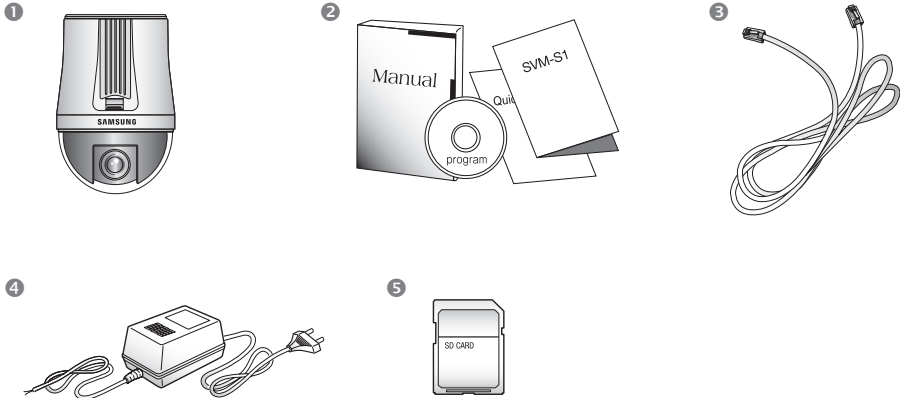

- ① Camera Body  
⑤ SD Card (2GB)

- ② User's Manual/CD/Quick Guide

- ③ Cross Cable

- ④ AC 24V Adapter

#### \* Accessories

The following items are sold separately from the camera.

#### Housing

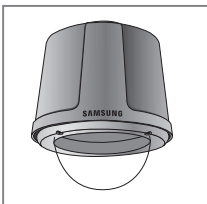

**STH-380NPO**  
Outdoor Housing for Very Low  
Temperature Environments  
(-40°~50°)

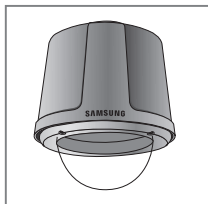

**STH-370NPI**  
Indoor Housing  
(-10°~50°)

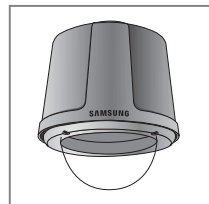

**STH-360NPO**  
Lightweight Outdoor  
Housing  
(-20°~50°)

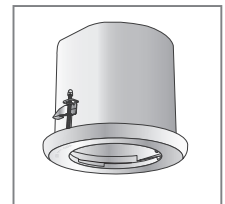

**STH-370NPE**  
Flush-Mount Indoor Housing  
for PTZ Dome Camera  
(-10°~50°)

## Brackets



**STB-350PPM**  
Parapet Mount

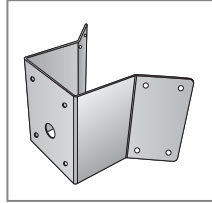

**STB-340PCM**  
Corner Mount

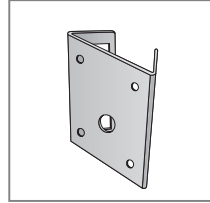

**STB-330PPM**  
Pole Mount

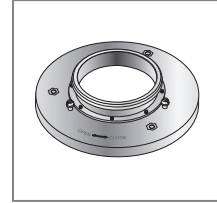

**STB-25PF**  
Indoor Flange

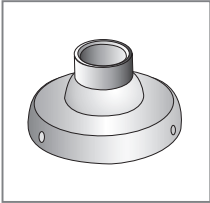

**STB-30PF**  
Indoor Flange

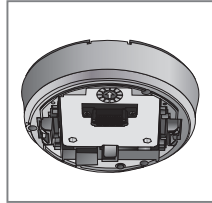

**STB-370NPC**  
Ceiling Installation Base

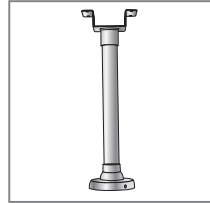

**STB-496PPV**  
Ceiling Bracket

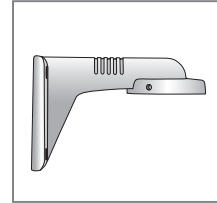

**STB-270PWV**  
Wall Bracket

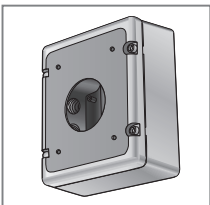

**STB-270B**  
Setup Box

## Chapter 2. Part Names & Functions

### 2.2. Camera Body

Front

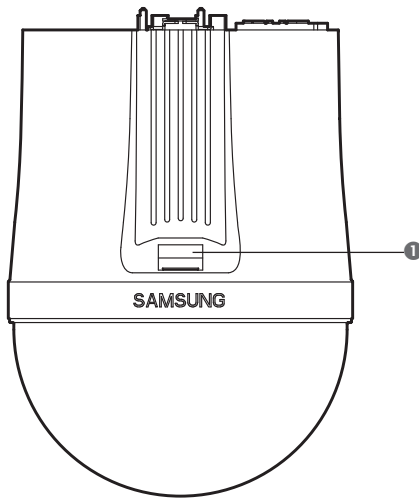

Side

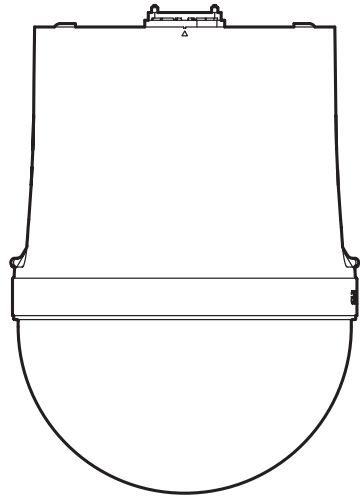

Bottom

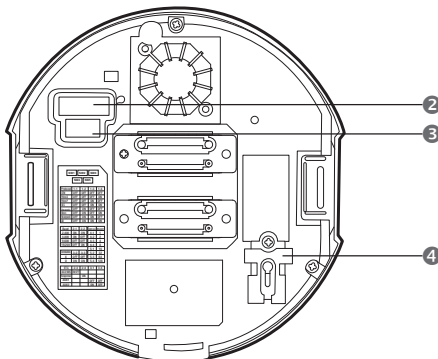

- ① Unlock Button
- ② SW1, SW2, SW3: Communication Switch
- ③ SW4, SW5: ID Switch
- ④ Safety Cable Hook

\* For instructions on configuring the switches, please refer to Page 16: 3.2 DIP Switch Settings.

### 2.3. Camera Wiring Interface Board (Sold Separately)

For the camera wiring, please refer to the picture below. The camera's wiring interface board is equipped in a housing and bracket that are sold separately.

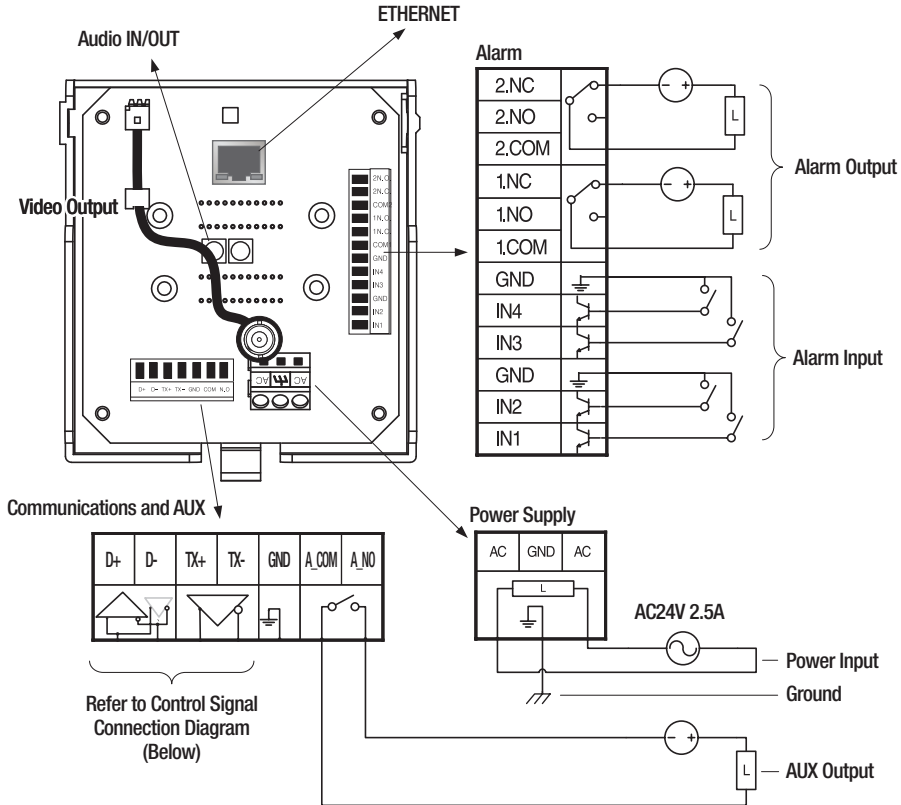

#### Control Signal Connection

##### RS485 Communications



##### RS422 Communications

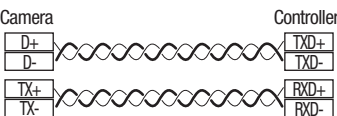

#### Caution

- The maximum power capacity of the alarm and AUX outputs is 30VDC/2A, 125VAC/0.5A, and 250VAC/0.25A.
- To connect products over the camera's capacity, please use an additional relay device.
- Connecting the power connector and GND incorrectly to the NC/NO and COM ports can cause a short circuit which may lead to fire and damage the camera.

# Chapter 3. Installing Camera & Network Setup

## 3.1. PTZ Dome Camera and Accessory Wiring Diagrams

Connecting to the NVR (SRN-3250/6450)

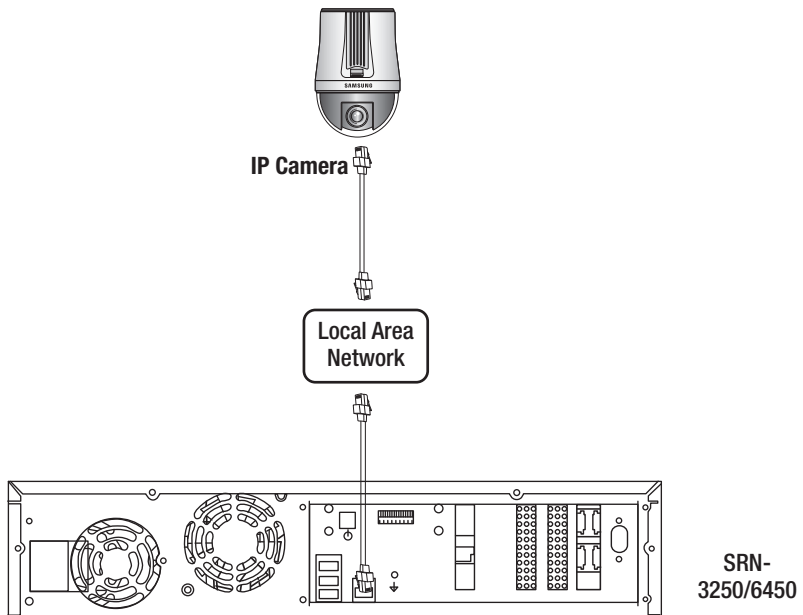

Connecting directly to the SCC-3100A controller

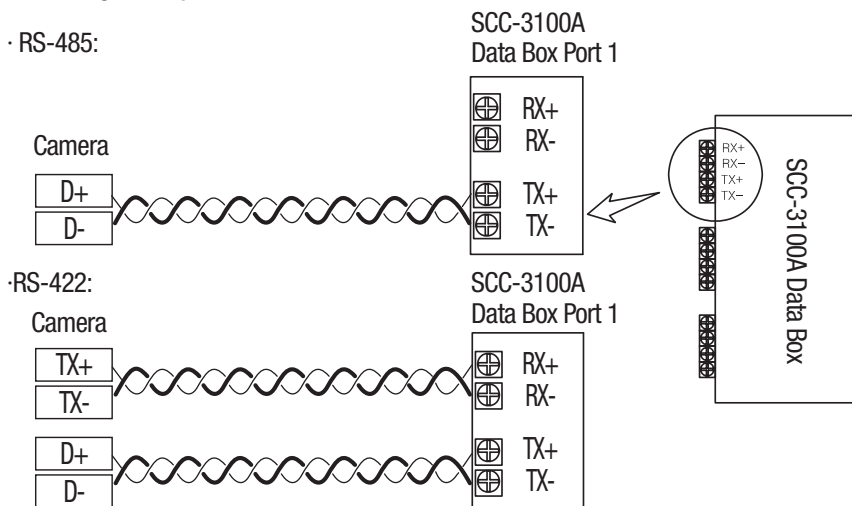

### 3.2. DIP Switch Settings

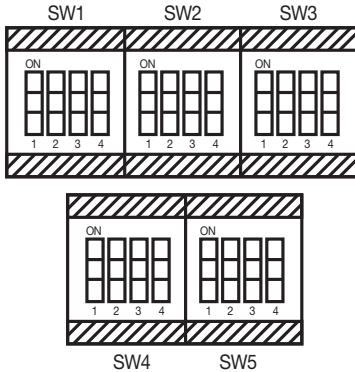

SW (Pin No.)	Purpose
SW1 (1~4)	Protocol Settings
SW2(1~2)	Baud Rate Settings
SW2(3)	Transfer Method Settings
SW2(4)	Response Mode Settings
SW3(1)	TBD
SW3(2~3)	Termination Settings
SW3(4)	TBD
SW4, SW5	Camera ID Setup

#### • Protocol Settings

Select a communication protocol for the camera.

No	Protocol	SW1-#1	SW1-#2	SW1-#3	SW1-#4
1	STW	OFF	OFF	OFF	OFF
2	Pelco-D	OFF	OFF	OFF	ON
3	Pelco-P	OFF	OFF	ON	OFF
4	SEC	OFF	OFF	ON	ON
5	Panasonic	OFF	ON	OFF	OFF
6	Vicon	OFF	ON	OFF	ON
7	Honeywell	OFF	ON	ON	OFF
8	AD	OFF	ON	ON	ON
9	Reserved	ON	OFF	OFF	OFF
10	Reserved	ON	OFF	OFF	ON
11	Reserved	ON	OFF	ON	OFF
12	Reserved	ON	OFF	ON	ON
13	Reserved	ON	ON	OFF	OFF
14	Reserved	ON	ON	OFF	ON
15	Reserved	ON	ON	ON	OFF
16	Reserved	ON	ON	ON	ON

※ Factory Release Mode: STW (OFF/OFF/OFF/OFF)

#### • Baud Rate Settings

Select the transfer speed for a selected communication protocol.

No	Baud Rate(BPS)	SW2-#1	SW2-#2
1	2,400	ON	ON
2	4,800	ON	OFF
3	9,600	OFF	OFF
4	19,200	OFF	ON

※ Factory Release Mode: 9,600BPS

## Chapter 3. Installing Camera & Network Setup

### • Communication Method Settings

Select a communication method for the camera.

	Function	ON	OFF
SW2- #3	Transfer Mode Switch	RS-422(4Wire)	RS-485(2Wire)

※ Factory Release Mode: RS-485(OFF)

### • Communication Response Settings

Select a communication response method for the camera and controller: Response or No Response.

	Function	ON	OFF
SW2- #4	SW2- #4	Response Mode Switch	No Response

※ Factory Release Mode: No Response(OFF)

### • Termination Settings

To prevent the attenuation of communication signals between the camera and controller, cameras that are a long distance from the camera and controller communication loop must be set up with the proper termination settings.

Camera Input Position	SW3- #2	SW3- #3
Longest Distance Terminal	ON	ON
In the Middle of the Loop	OFF	OFF

※ Factory Release Mode: In the Middle of the Loop (OFF/OFF)

### \*Note

- To use a third party controller with this product, please contact our After-Sales Service or Technical Department.
- AD Protocol Control Method
  1. Input Camera OSD: 3+Auxiliary ON
  2. Output Camera OSD: 3+Auxiliary OFF
  3. Enter: IRIS Open
  4. Esc: IRIS Closed
- For more information about the protocols, please refer to our official website.

• Camera ID Chart

ID	SW4-#1	SW4-#2	SW4-#3	SW4-#4	SW5-#1	SW5-#2	SW5-#3	SW5-#4
1	ON/OFF	OFF	OFF	OFF	OFF	OFF	OFF	OFF
2	OFF	ON	OFF	OFF	OFF	OFF	OFF	OFF
3	ON	ON	OFF	OFF	OFF	OFF	OFF	OFF
4	OFF	OFF	ON	OFF	OFF	OFF	OFF	OFF
5	ON	OFF	ON	OFF	OFF	OFF	OFF	OFF
6	OFF	ON	ON	OFF	OFF	OFF	OFF	OFF
7	ON	ON	ON	OFF	OFF	OFF	OFF	OFF
8	OFF	OFF	OFF	ON	OFF	OFF	OFF	OFF
9	ON	OFF	OFF	ON	OFF	OFF	OFF	OFF
10	OFF	ON	OFF	ON	OFF	OFF	OFF	OFF
11	ON	ON	OFF	ON	OFF	OFF	OFF	OFF
12	OFF	OFF	ON	ON	OFF	OFF	OFF	OFF
13	ON	OFF	ON	ON	OFF	OFF	OFF	OFF
14	OFF	ON	ON	ON	OFF	OFF	OFF	OFF
15	ON	ON	ON	ON	OFF	OFF	OFF	OFF
16	OFF	OFF	OFF	OFF	ON	OFF	OFF	OFF
17	ON	OFF	OFF	OFF	ON	OFF	OFF	OFF
18	OFF	ON	OFF	OFF	ON	OFF	OFF	OFF
19	ON	ON	OFF	OFF	ON	OFF	OFF	OFF
20	OFF	OFF	ON	OFF	ON	OFF	OFF	OFF
21	ON	OFF	ON	OFF	ON	OFF	OFF	OFF
22	OFF	ON	ON	OFF	ON	OFF	OFF	OFF
23	ON	ON	ON	OFF	ON	OFF	OFF	OFF
24	OFF	OFF	OFF	ON	ON	OFF	OFF	OFF
25	ON	OFF	OFF	ON	ON	OFF	OFF	OFF
26	OFF	ON	OFF	ON	ON	OFF	OFF	OFF
27	ON	ON	OFF	ON	ON	OFF	OFF	OFF
28	OFF	OFF	ON	ON	ON	OFF	OFF	OFF
29	ON	OFF	ON	ON	ON	OFF	OFF	OFF
30	OFF	ON	ON	ON	ON	OFF	OFF	OFF
31	ON	ON	ON	ON	ON	OFF	OFF	OFF
32	OFF	OFF	OFF	OFF	OFF	ON	OFF	OFF
33	ON	OFF	OFF	OFF	OFF	ON	OFF	OFF
34	OFF	ON	OFF	OFF	OFF	ON	OFF	OFF
35	ON	ON	OFF	OFF	OFF	ON	OFF	OFF
36	OFF	OFF	ON	OFF	OFF	ON	OFF	OFF
37	ON	OFF	ON	OFF	OFF	ON	OFF	OFF
38	OFF	ON	ON	OFF	OFF	ON	OFF	OFF
39	ON	ON	ON	OFF	OFF	ON	OFF	OFF
40	OFF	OFF	OFF	ON	OFF	ON	OFF	OFF
41	ON	OFF	OFF	ON	OFF	ON	OFF	OFF

## Chapter 3. Installing Camera & Network Setup

ID	SW4-#1	SW4-#2	SW4-#3	SW4-#4	SW5-#1	SW5-#2	SW5-#3	SW5-#4
42	OFF	ON	OFF	ON	OFF	ON	OFF	OFF
43	ON	ON	OFF	ON	OFF	ON	OFF	OFF
44	OFF	OFF	ON	ON	OFF	ON	OFF	OFF
45	ON	OFF	ON	ON	OFF	ON	OFF	OFF
46	OFF	ON	ON	ON	OFF	ON	OFF	OFF
47	ON	ON	ON	ON	OFF	ON	OFF	OFF
48	OFF	OFF	OFF	OFF	ON	ON	OFF	OFF
49	ON	OFF	OFF	OFF	ON	ON	OFF	OFF
50	OFF	ON	OFF	OFF	ON	ON	OFF	OFF
51	ON	ON	OFF	OFF	ON	ON	OFF	OFF
52	OFF	OFF	ON	OFF	ON	ON	OFF	OFF
53	ON	OFF	ON	OFF	ON	ON	OFF	OFF
54	OFF	ON	ON	OFF	ON	ON	OFF	OFF
55	ON	ON	ON	OFF	ON	ON	OFF	OFF
56	OFF	OFF	OFF	ON	ON	ON	OFF	OFF
57	ON	OFF	OFF	ON	ON	ON	OFF	OFF
58	OFF	ON	OFF	ON	ON	ON	OFF	OFF
59	ON	ON	OFF	ON	ON	ON	OFF	OFF
60	OFF	OFF	ON	ON	ON	ON	OFF	OFF
61	ON	OFF	ON	ON	ON	ON	OFF	OFF
62	OFF	ON	ON	ON	ON	ON	OFF	OFF
63	ON	ON	ON	ON	ON	ON	OFF	OFF
64	OFF	OFF	OFF	OFF	OFF	OFF	ON	OFF
65	ON	OFF	OFF	OFF	OFF	OFF	ON	OFF
66	OFF	ON	OFF	OFF	OFF	OFF	ON	OFF
67	ON	ON	OFF	OFF	OFF	OFF	ON	OFF
68	OFF	OFF	ON	OFF	OFF	OFF	ON	OFF
69	ON	OFF	ON	OFF	OFF	OFF	ON	OFF
70	OFF	ON	ON	OFF	OFF	OFF	ON	OFF
71	ON	ON	ON	OFF	OFF	OFF	ON	OFF
72	OFF	OFF	OFF	ON	OFF	OFF	ON	OFF
73	ON	OFF	OFF	ON	OFF	OFF	ON	OFF
74	OFF	ON	OFF	ON	OFF	OFF	ON	OFF
75	ON	ON	OFF	ON	OFF	OFF	ON	OFF
76	OFF	OFF	ON	ON	OFF	OFF	ON	OFF
77	ON	OFF	ON	ON	OFF	OFF	ON	OFF
78	OFF	ON	ON	ON	OFF	OFF	ON	OFF
79	ON	ON	ON	ON	OFF	OFF	ON	OFF
80	OFF	OFF	OFF	OFF	ON	OFF	ON	OFF
81	ON	OFF	OFF	OFF	ON	OFF	ON	OFF
82	OFF	ON	OFF	OFF	ON	OFF	ON	OFF
83	ON	ON	OFF	OFF	ON	OFF	ON	OFF
84	OFF	OFF	ON	OFF	ON	OFF	ON	OFF

ID	SW4-#1	SW4-#2	SW4-#3	SW4-#4	SW5-#1	SW5-#2	SW5-#3	SW5-#4
85	ON	OFF	ON	OFF	ON	OFF	ON	OFF
86	OFF	ON	ON	OFF	ON	OFF	ON	OFF
87	ON	ON	ON	OFF	ON	OFF	ON	OFF
88	OFF	OFF	OFF	ON	ON	OFF	ON	OFF
89	ON	OFF	OFF	ON	ON	OFF	ON	OFF
90	OFF	ON	OFF	ON	ON	OFF	ON	OFF
91	ON	ON	OFF	ON	ON	OFF	ON	OFF
92	OFF	OFF	ON	ON	ON	OFF	ON	OFF
93	ON	OFF	ON	ON	ON	OFF	ON	OFF
94	OFF	ON	ON	ON	ON	OFF	ON	OFF
95	ON	ON	ON	ON	ON	OFF	ON	OFF
96	OFF	OFF	OFF	OFF	OFF	ON	ON	OFF
97	ON	OFF	OFF	OFF	OFF	ON	ON	OFF
98	OFF	ON	OFF	OFF	OFF	ON	ON	OFF
99	ON	ON	OFF	OFF	OFF	ON	ON	OFF
100	OFF	OFF	ON	OFF	OFF	ON	ON	OFF
101	ON	OFF	ON	OFF	OFF	ON	ON	OFF
102	OFF	ON	ON	OFF	OFF	ON	ON	OFF
103	ON	ON	ON	OFF	OFF	ON	ON	OFF
104	OFF	OFF	OFF	ON	OFF	ON	ON	OFF
105	ON	OFF	OFF	ON	OFF	ON	ON	OFF
106	OFF	ON	OFF	ON	OFF	ON	ON	OFF
107	ON	ON	OFF	ON	OFF	ON	ON	OFF
108	OFF	OFF	ON	ON	OFF	ON	ON	OFF
109	ON	OFF	ON	ON	OFF	ON	ON	OFF
110	OFF	ON	ON	ON	OFF	ON	ON	OFF
111	ON	ON	ON	ON	OFF	ON	ON	OFF
112	OFF	OFF	OFF	OFF	ON	ON	ON	OFF
113	ON	OFF	OFF	OFF	ON	ON	ON	OFF
114	OFF	ON	OFF	OFF	ON	ON	ON	OFF
115	ON	ON	OFF	OFF	ON	ON	ON	OFF
116	OFF	OFF	ON	OFF	ON	ON	ON	OFF
117	ON	OFF	ON	OFF	ON	ON	ON	OFF
118	OFF	ON	ON	OFF	ON	ON	ON	OFF
119	ON	ON	ON	OFF	ON	ON	ON	OFF
120	OFF	OFF	OFF	ON	ON	ON	ON	OFF
121	ON	OFF	OFF	ON	ON	ON	ON	OFF
122	OFF	ON	OFF	ON	ON	ON	ON	OFF
123	ON	ON	OFF	ON	ON	ON	ON	OFF
124	OFF	OFF	ON	ON	ON	ON	ON	OFF
125	ON	OFF	ON	ON	ON	ON	ON	OFF
126	OFF	ON	ON	ON	ON	ON	ON	OFF
127	ON	ON	ON	ON	ON	ON	ON	OFF

## Chapter 3. Installing Camera & Network Setup

ID	SW4-#1	SW4-#2	SW4-#3	SW4-#4	SW5-#1	SW5-#2	SW5-#3	SW5-#4
128	OFF	OFF	OFF	OFF	OFF	OFF	OFF	ON
129	ON	OFF	OFF	OFF	OFF	OFF	OFF	ON
130	OFF	ON	OFF	OFF	OFF	OFF	OFF	ON
131	ON	ON	OFF	OFF	OFF	OFF	OFF	ON
132	OFF	OFF	ON	OFF	OFF	OFF	OFF	ON
133	ON	OFF	ON	OFF	OFF	OFF	OFF	ON
134	OFF	ON	ON	OFF	OFF	OFF	OFF	ON
135	ON	ON	ON	OFF	OFF	OFF	OFF	ON
136	OFF	OFF	OFF	ON	OFF	OFF	OFF	ON
137	ON	OFF	OFF	ON	OFF	OFF	OFF	ON
138	OFF	ON	OFF	ON	OFF	OFF	OFF	ON
139	ON	ON	OFF	ON	OFF	OFF	OFF	ON
140	OFF	OFF	ON	ON	OFF	OFF	OFF	ON
141	ON	OFF	ON	ON	OFF	OFF	OFF	ON
142	OFF	ON	ON	ON	OFF	OFF	OFF	ON
143	ON	ON	ON	ON	OFF	OFF	OFF	ON
144	OFF	OFF	OFF	OFF	ON	OFF	OFF	ON
145	ON	OFF	OFF	OFF	ON	OFF	OFF	ON
146	OFF	ON	OFF	OFF	ON	OFF	OFF	ON
147	ON	ON	OFF	OFF	ON	OFF	OFF	ON
148	OFF	OFF	ON	OFF	ON	OFF	OFF	ON
149	ON	OFF	ON	OFF	ON	OFF	OFF	ON
150	OFF	ON	ON	OFF	ON	OFF	OFF	ON
151	ON	ON	ON	OFF	ON	OFF	OFF	ON
152	OFF	OFF	OFF	ON	ON	OFF	OFF	ON
153	ON	OFF	OFF	ON	ON	OFF	OFF	ON
154	OFF	ON	OFF	ON	ON	OFF	OFF	ON
155	ON	ON	OFF	ON	ON	OFF	OFF	ON
156	OFF	OFF	ON	ON	ON	OFF	OFF	ON
157	ON	OFF	ON	ON	ON	OFF	OFF	ON
158	OFF	ON	ON	ON	ON	OFF	OFF	ON
159	ON	ON	ON	ON	ON	OFF	OFF	ON
160	OFF	OFF	OFF	OFF	OFF	ON	OFF	ON
161	ON	OFF	OFF	OFF	OFF	ON	OFF	ON
162	OFF	ON	OFF	OFF	OFF	ON	OFF	ON
163	ON	ON	OFF	OFF	OFF	ON	OFF	ON
164	OFF	OFF	ON	OFF	OFF	ON	OFF	ON
165	ON	OFF	ON	OFF	OFF	ON	OFF	ON
166	OFF	ON	ON	OFF	OFF	ON	OFF	ON
167	ON	ON	ON	OFF	OFF	ON	OFF	ON
168	OFF	OFF	OFF	ON	OFF	ON	OFF	ON
169	ON	OFF	OFF	ON	OFF	ON	OFF	ON
170	OFF	ON	OFF	ON	OFF	ON	OFF	ON

ID	SW4-#1	SW4-#2	SW4-#3	SW4-#4	SW5-#1	SW5-#2	SW5-#3	SW5-#4
171	ON	ON	OFF	ON	OFF	ON	OFF	ON
172	OFF	OFF	ON	ON	OFF	ON	OFF	ON
173	ON	OFF	ON	ON	OFF	ON	OFF	ON
174	OFF	ON	ON	ON	OFF	ON	OFF	ON
175	ON	ON	ON	ON	OFF	ON	OFF	ON
176	OFF	OFF	OFF	OFF	ON	ON	OFF	ON
177	ON	OFF	OFF	OFF	ON	ON	OFF	ON
178	OFF	ON	OFF	OFF	ON	ON	OFF	ON
179	ON	ON	OFF	OFF	ON	ON	OFF	ON
180	OFF	OFF	ON	OFF	ON	ON	OFF	ON
181	ON	OFF	ON	OFF	ON	ON	OFF	ON
182	OFF	ON	ON	OFF	ON	ON	OFF	ON
183	ON	ON	ON	OFF	ON	ON	OFF	ON
184	OFF	OFF	OFF	ON	ON	ON	OFF	ON
185	ON	OFF	OFF	ON	ON	ON	OFF	ON
186	OFF	ON	OFF	ON	ON	ON	OFF	ON
187	ON	ON	OFF	ON	ON	ON	OFF	ON
188	OFF	OFF	ON	ON	ON	ON	OFF	ON
189	ON	OFF	ON	ON	ON	ON	OFF	ON
190	OFF	ON	ON	ON	ON	ON	OFF	ON
191	ON	ON	ON	ON	ON	ON	OFF	ON
192	OFF	OFF	OFF	OFF	OFF	OFF	ON	ON
193	ON	OFF	OFF	OFF	OFF	OFF	ON	ON
194	OFF	ON	OFF	OFF	OFF	OFF	ON	ON
195	ON	ON	OFF	OFF	OFF	OFF	ON	ON
196	OFF	OFF	ON	OFF	OFF	OFF	ON	ON
197	ON	OFF	ON	OFF	OFF	OFF	ON	ON
198	OFF	ON	ON	OFF	OFF	OFF	ON	ON
199	ON	ON	ON	OFF	OFF	OFF	ON	ON
200	OFF	OFF	OFF	ON	OFF	OFF	ON	ON
201	ON	OFF	OFF	ON	OFF	OFF	ON	ON
202	OFF	ON	OFF	ON	OFF	OFF	ON	ON
203	ON	ON	OFF	ON	OFF	OFF	ON	ON
204	OFF	OFF	ON	ON	OFF	OFF	ON	ON
205	ON	OFF	ON	ON	OFF	OFF	ON	ON
206	OFF	ON	ON	ON	OFF	OFF	ON	ON
207	ON	ON	ON	ON	OFF	OFF	ON	ON
208	OFF	OFF	OFF	OFF	ON	OFF	ON	ON
209	ON	OFF	OFF	OFF	ON	OFF	ON	ON
210	OFF	ON	OFF	OFF	ON	OFF	ON	ON
211	ON	ON	OFF	OFF	ON	OFF	ON	ON
212	OFF	OFF	ON	OFF	ON	OFF	ON	ON
213	ON	OFF	ON	OFF	ON	OFF	ON	ON

## Chapter 3. Installing Camera & Network Setup

ID	SW4-#1	SW4-#2	SW4-#3	SW4-#4	SW5-#1	SW5-#2	SW5-#3	SW5-#4
214	OFF	ON	ON	OFF	ON	OFF	ON	ON
215	ON	ON	ON	OFF	ON	OFF	ON	ON
216	OFF	OFF	OFF	ON	ON	OFF	ON	ON
217	ON	OFF	OFF	ON	ON	OFF	ON	ON
218	OFF	ON	OFF	ON	ON	OFF	ON	ON
219	ON	ON	OFF	ON	ON	OFF	ON	ON
220	OFF	OFF	ON	ON	ON	OFF	ON	ON
221	ON	OFF	ON	ON	ON	OFF	ON	ON
222	OFF	ON	ON	ON	ON	OFF	ON	ON
223	ON	ON	ON	ON	ON	OFF	ON	ON
224	OFF	OFF	OFF	OFF	OFF	ON	ON	ON
225	ON	OFF	OFF	OFF	OFF	ON	ON	ON
226	OFF	ON	OFF	OFF	OFF	ON	ON	ON
227	ON	ON	OFF	OFF	OFF	ON	ON	ON
228	OFF	OFF	ON	OFF	OFF	ON	ON	ON
229	ON	OFF	ON	OFF	OFF	ON	ON	ON
230	OFF	ON	ON	OFF	OFF	ON	ON	ON
231	ON	ON	ON	OFF	OFF	ON	ON	ON
232	OFF	OFF	OFF	ON	OFF	ON	ON	ON
233	ON	OFF	OFF	ON	OFF	ON	ON	ON
234	OFF	ON	OFF	ON	OFF	ON	ON	ON
235	ON	ON	OFF	ON	OFF	ON	ON	ON
236	OFF	OFF	ON	ON	OFF	ON	ON	ON
237	ON	OFF	ON	ON	OFF	ON	ON	ON
238	OFF	ON	ON	ON	OFF	ON	ON	ON
239	ON	ON	ON	ON	OFF	ON	ON	ON
240	OFF	OFF	OFF	OFF	ON	ON	ON	ON
241	ON	OFF	OFF	OFF	ON	ON	ON	ON
242	OFF	ON	OFF	OFF	ON	ON	ON	ON
243	ON	ON	OFF	OFF	ON	ON	ON	ON
244	OFF	OFF	ON	OFF	ON	ON	ON	ON
245	ON	OFF	ON	OFF	ON	ON	ON	ON
246	OFF	ON	ON	OFF	ON	ON	ON	ON
247	ON	ON	ON	OFF	ON	ON	ON	ON
248	OFF	OFF	OFF	ON	ON	ON	ON	ON
249	ON	OFF	OFF	ON	ON	ON	ON	ON
250	OFF	ON	OFF	ON	ON	ON	ON	ON
251	ON	ON	OFF	ON	ON	ON	ON	ON
252	OFF	OFF	ON	ON	ON	ON	ON	ON
253	ON	OFF	ON	ON	ON	ON	ON	ON
254	OFF	ON	ON	ON	ON	ON	ON	ON
255	ON	ON	ON	ON	ON	ON	ON	ON

### 3.3. Preparing Adapter and Cable

#### - Power Adapter

The SNP-3370/3301 uses an AC24V 2.5A power adapter for the power supply.

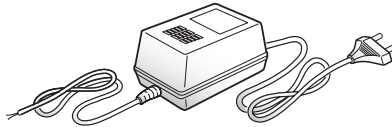

Plug the power adapter into a power outlet.

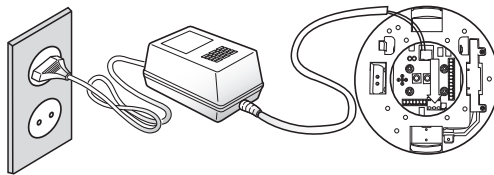

Chart 3-1. Electrical Resistance of Copper Wire at [20° (68°)]

Copper Wire Gauge (AWG)	#24(0.22°)	#22(0.33°)	#20(0.52°)	#18(0.83°)
Resistance ( $\Omega$ /m)	0.078	0.050	0.030	0.018
Drop Voltage (V/m)	0.028	0.018	0.011	0.06

• As shown in Chart 3-1, voltage drop may occur depending on the length of the copper cable: excessively lengthening the adapter cable may decrease the performance of the camera.

※ Camera Operating Voltage: AC 24V±10%

※ Voltage drop measurements on the chart above may vary depending on the type and manufacture of the copper cable.

#### - Communications Cable

For the camera to communicate with the controller, a RS-485/422 communications line is required.

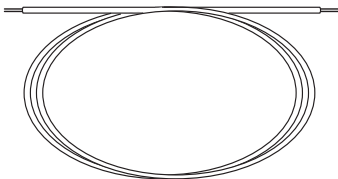

#### Caution

- A 30m or shorter length is recommended for the connection.

\* The communication cable is not enclosed with the camera.

## Chapter 3. Installing Camera & Network Setup

### 3.4. Connecting Monitor

Connect the cable to the camera's rear video output terminal and the monitor's video input terminal.

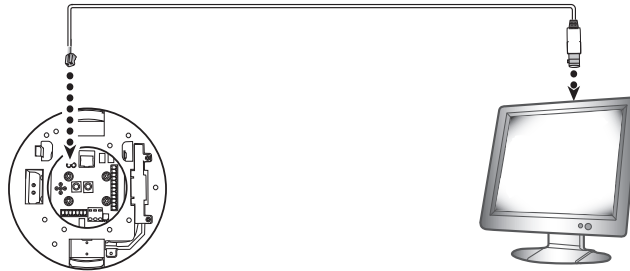

37x/30x PTZ Network Camera  
SNP-3370/3301

Monitor

- The wiring varies depending on your monitor type and peripheral devices; please refer to the user manual for each device.
- Please make sure the monitor and camera are turned off when connecting them.
- As shown in the picture below, set the 75Ω/Hi-Z switch of each device to Hi-Z for the intermediate video receiver and to 75Ω for the end device.

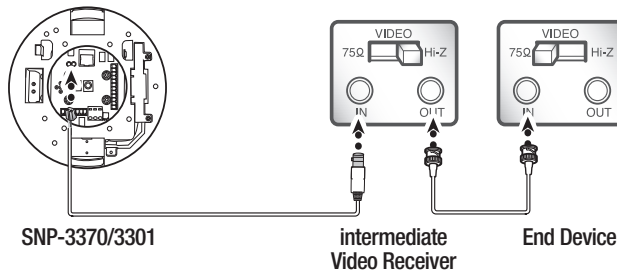

SNP-3370/3301

intermediate  
Video Receiver

End Device



#### **Caution**

- This product is a network camera that transfers video over a network; the video output terminal is used to set the imaging range of the camera at installation.
- Using the terminal for monitoring purposes may cause problems such as degradation in video quality.

### 3.5. Preparing & Installing Camera Bracket

For installation guidelines for brackets and housings, refer to the installation manual that is enclosed with the bracket or housing.

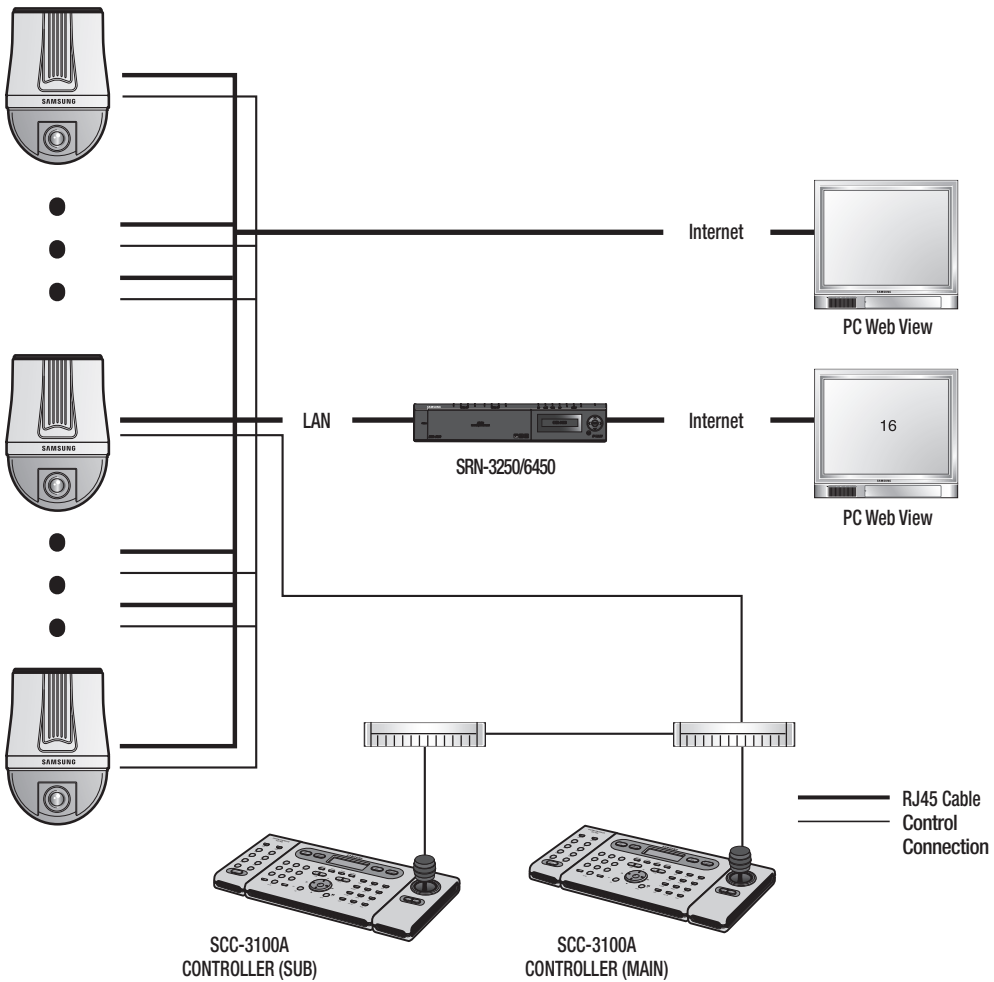

## Chapter 3. Installing Camera & Network Setup

### 3.6. Ceiling Installation Example

#### - Attaching Template & Installing STB-370NPC

Attach the enclosed template to the ceiling, then drill a hole in the ceiling according to the 88mm diameter hole marked on the template. Drop the camera cables down from the ceiling through the hole. Next, install the base, STB-370NPC, to the ceiling as shown in the picture.

Before installing the exposed bracket, open the hinged door at the bottom of the bracket as shown in the picture. Hold the knob on the hinged door to open it.

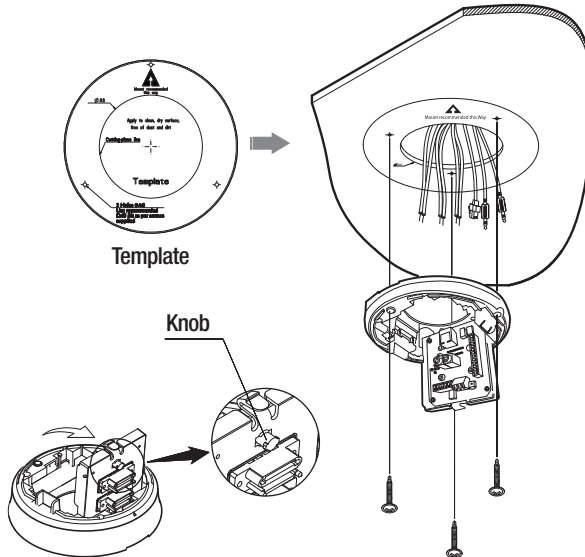

#### - Connect Terminal Wires

Connect the cables to the terminal block on the hinged door.

When connecting, please refer to 2.2 Camera Wiring Interface Board. Once the wiring is complete, close the hinged door.

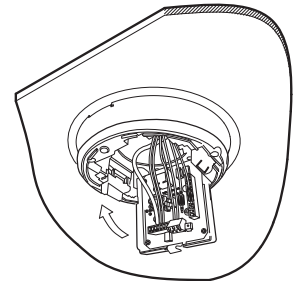

### Caution

- Do not connect the camera to a power outlet until the installation is complete. Supplying power while the installation is in progress may cause fire or damage the product.

### - Configuring Camera DIP Switches

DIP switches for communication and ID protocols are located on the bottom of the camera. For more instructions, please refer to 3.2 DIP Switch Settings(Page 25).

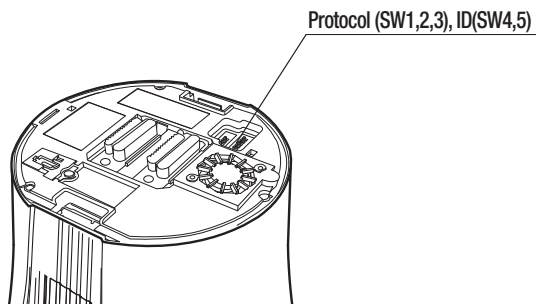

### - Connecting Camera Safety Cable and Attaching Camera

Carefully attach the camera to the mount following the alignment guide marks as shown in the picture. First, hook the camera's safety cable on the mount, and then attach the camera. The safety cable is coiled inside the base. As shown in the left hand picture, pull out the safety cable from the base and then hook it to the mount.

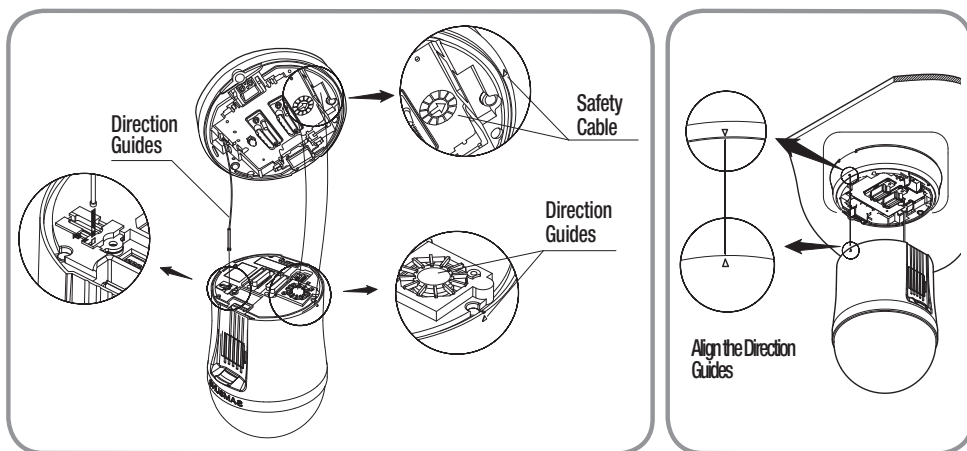

※ To attach the camera to the mount, refer to the alignment guide marks as shown in the picture.



### **Caution**

- Make sure to hook the camera's safety cable to the mount before proceeding. Otherwise you may be exposed to serious injury caused by the camera falling.

## Chapter 3. Installing Camera & Network Setup

- ※ To attach or detach the camera, refer to the picture.
- \* Attaching the Camera: Hold up the camera and push it to the mount as shown in the picture. Push the camera until you hear a "click".
- \* Detaching the Camera: To detach the camera, pull the camera downward while pushing up the unlock buttons on the camera.

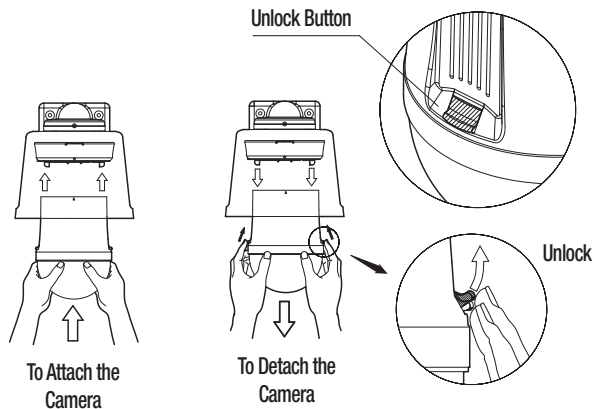

### 3.7. Network Configuration & Connection via Website

Use these instructions if you are using a single SNP-3370/3301 37x/30x PTZ network camera.

1. Connect the SNP-3370/3301 37x/30x PTZ network camera to a computer with a cross cable.

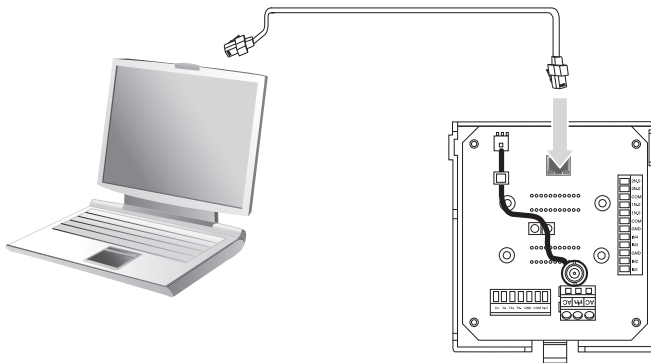



**Notes** For the network settings, you must register the internal IP of your computer. To register the IP, go to My Network Environment → Properties → Local Area Connection → Properties.

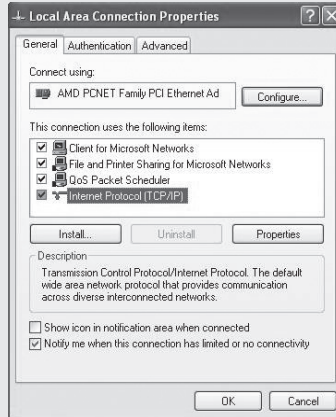

Next, select Internet Protocol (TCP/IP) and click the "Properties" button below, then press "Advanced . . ." to set advanced options for your product.

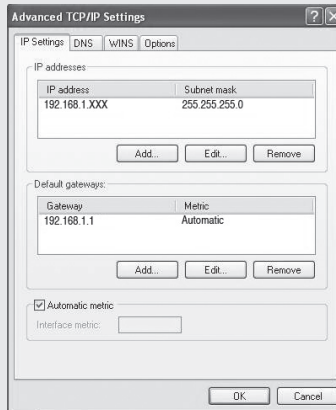

- 192.168.1.XXX as the internal IP of your computer. (XXX: 0 ~ 255)



### Caution

- 192.168.1.100 is the IP address for the camera and will be unavailable as the internal IP address for your computer.

## Chapter 3. Installing Camera & Network Setup

2. Open the internet browser on your computer, enter [192.168.1.100] in the address bar, and then press <Enter>.

You will be connected to the Web Viewer login page for the SNP-3370/3301 37x/30x PTZ network camera.

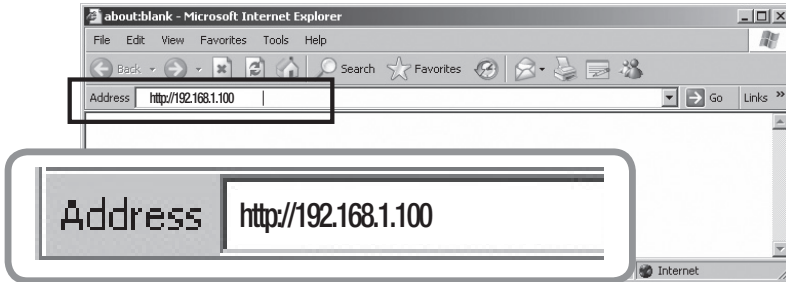

3. Log in with an administrator account, and then move to the "Config → Network" page.



**Notes** The default administrator login information is ID: admin, and PW: 4321.

4. Once you have moved to the "Config → Network" page, configure the network settings for the SNP-3370/3301 network camera. To save the new settings, press <Apply>.

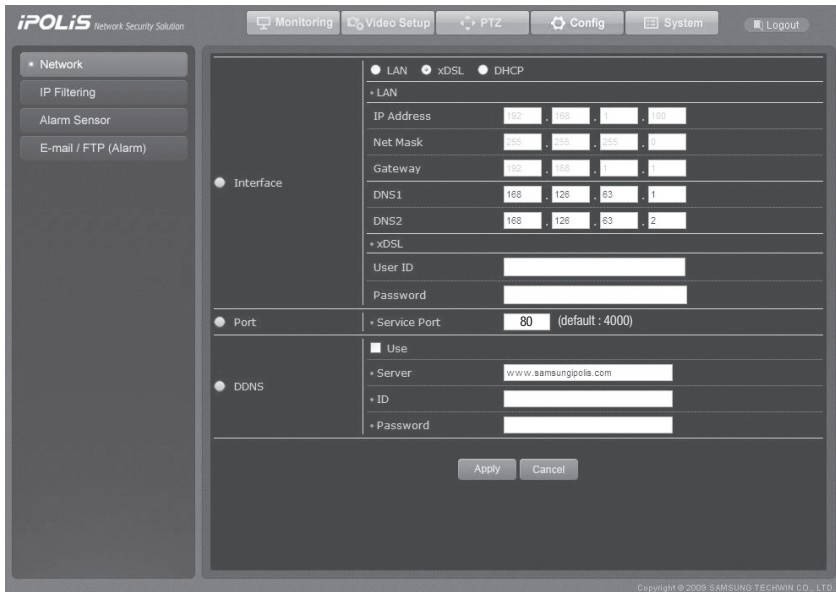

### ① LAN / xDSL / DHCP Setup

Category	Description
LAN	Enter the network information of the camera to connect it to a local network or assign it to a static IP.
xDSL	When using xDSL, enter the xDSL ID and password.
DHCP	If the camera receives an IP address automatically from a DHCP server, use this DHCP option. "DHCP" is used in an LAN environment with a DHCP server. Generally, medium to large networks run a DHCP server on a LAN while small networks use the DHCP function of IP routers.

## Chapter 3. Installing Camera & Network Setup

### ② Port Setup

Port	Service Port	80
------	--------------	----

Category	Description
Port Setup	Select a service port; the default is 80.



**Notes** When a device is connected to a cable or xDSL modem, its IP address keeps changing each time it attempts to connect to the ISP (Internet Service Provider) so you cannot check the new IP address of the device. DDNS is useful for situations like this, involving products with dynamic IPs. You can easily check the new IP address of your products by registering them to our DDNS server at [www.samsungipolis.com](http://www.samsungipolis.com). To use the DDNS service, first register the product to the DDNS server. Come back to this page, select Enable under the Use DDNS option, and then enter the ID and password that was submitted to the DDNS server. For more information, please refer to Page 50: “Using DDNS.”

## Chapter 4. Using Web Viewer

### 4.1. Using Web Viewer

#### 4.1.1. Login

Enter the IP address of your camera in an internet browser, and then press Enter to connect to the Web Viewer login page.

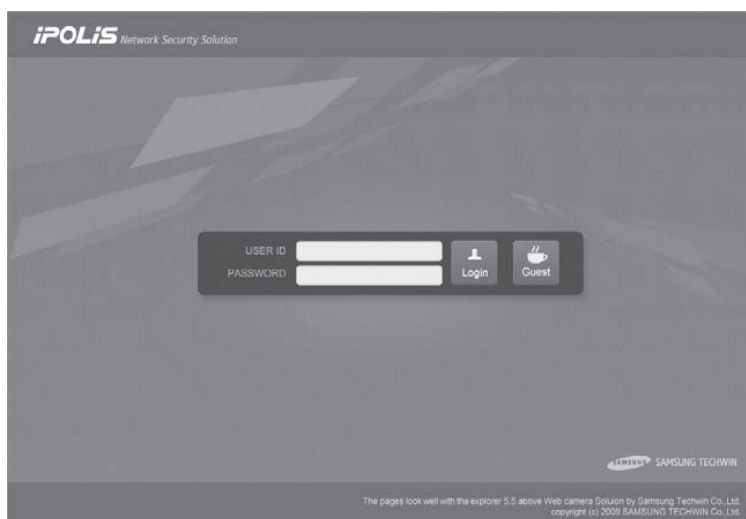

Enter your user ID and password, and then click <Login> to move to the next page.



**Notes** The default administrator login information is ID: admin, and PW: 4321.

The <Guest> button can be used for access only if the Guess Access option is checked in System → User → Guest Setup.



**Notes** Please change the password of your administrator account upon the first login. It helps you prevent unauthorized users from connecting to the administrator page.

# Chapter 4. Using Web Viewer

## 4.1.2. Monitoring Screen

The monitoring screen consists of a menu area for the camera and video settings and a display area for the video feed from the camera.



### 1Ch Display

Displays only one video in the display area; the SNP-3370/3301 supports only one channel at this time.



### Flip Image

Inverts the screen from top to bottom.

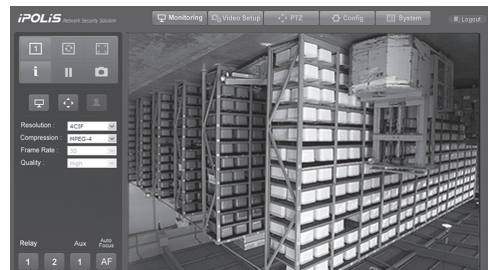



## Stretch Image

Expands the screen to the size of 4CIF when selecting CIF and QCIF for resolution.

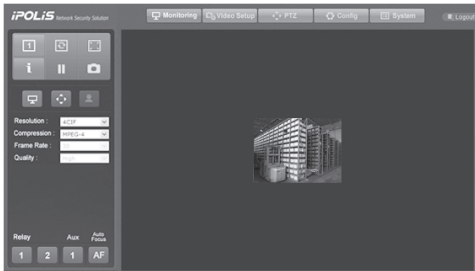
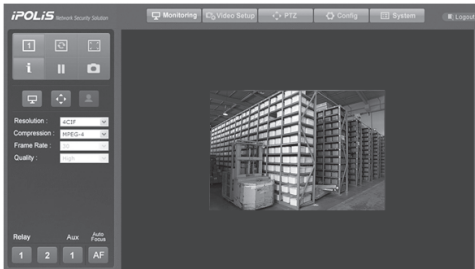

## Caution

- This Stretch Image option is not available at 4CIF resolution.



## Information

Displays information about the current channel: name, time, date, etc.



## Chapter 4. Using Web Viewer



### Save Image

Saves the channel screen as a JPEG file.



### Basic

Select a screen resolution and image compression type.

- Resolution  
(For more instructions on selecting a resolution, please refer to the Video Setup → Video/Audio page.)
  - 4CIF
  - CIF
  - QCIF
- Compression Types
  - MPEG-4 / H.264
  - M-JPEG
- Frame Rate
  - A maximum number of frames to transfer per second.
- Video Quality
  - Displays the video quality.







### PTZ

Controls the PTZ operation of the camera.

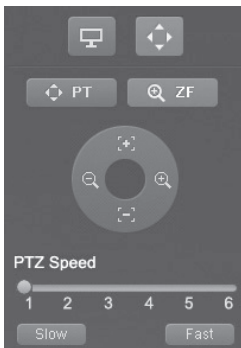



 **PT** Changes the direction to which the camera faces. Clicking the button displays a circular button as shown below. Click an arrow on the circular button to rotate the camera in that direction.

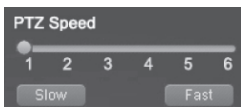

 **ZF** Adjusts the zoom and focus of the camera. Clicking the button displays a circular button as shown below.   Click a symbol on the circular button to zoom the camera in or out, or  adjust the focus.



You can adjust the PTZ speed with the slider at the bottom of the page. A total of 6 different PTZ speed levels are available. Click  to decrease the PTZ speed by one step, and  to increase it by one step. 1 is the slowest PTZ speed setting while 6 is the fastest.



### Video Analytics

Controls the Video Analytics operation of the camera.

## Chapter 4. Using Web Viewer



α

### Alpha Blending

Makes changed parts appear half-transparent.

RESET

### Reset

Select the current screen as the background image.

※ For more information about "Video Analytics" please refer to 4.2.1.4 Video Analytics.

Relay

1

### Relay

Turns a connected relay on or off.

Aux

1

### Aux

Turns a connected AUX on or off.

Auto  
Focus

AF

### Auto Focus

Automatically adjusts the camera's focus on the current screen.



### Caution

- If neither a relay nor an AUX is connected to the camera, clicking this button does not turn the relay/AUX on or off, even if the button turns blue when pressed.

## 4.2. Administrator Page

### 4.2.1. Video Setup

The following page appears when selecting **Video Setup** at the top of the screen. Buttons on the left side of the screen move to the relevant menu page.

#### 4.2.1.1 Video / Audio

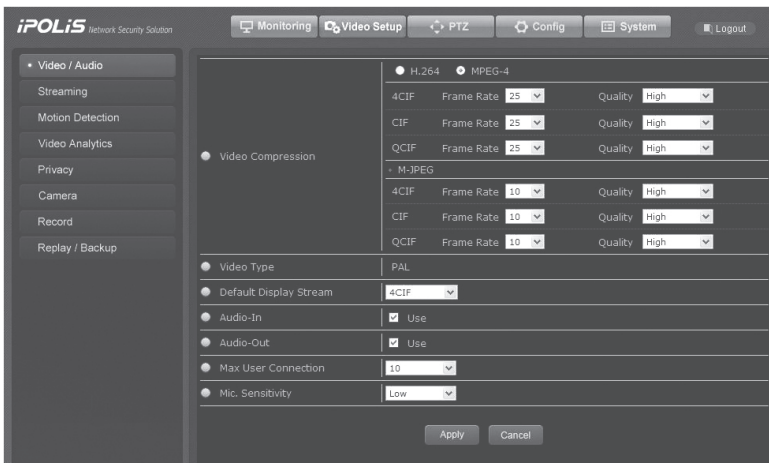

Category	Description
Video Compression	Select a resolution according to a video format: H.264/MPEG-4 or M-JPEG. You can also adjust the frame rate and quality of each video format.
Video Type	Displays the current video type: NTSC or PAL.
Default Display Stream	You can select Default as the resolution at the Monitoring page.
Audio - In	Check to use an audio input channel.
Audio - Out	Check to use an audio output channel.

## Chapter 4. Using Web Viewer

Max User Connection	Select a number to limit the concurrent users.
Mic. Sensitivity	Adjusts the sensitivity of an audio mic. Set this to Low for an amplifiable mic and High for others. (Set to Low for non-mic line-in signals.)



### **Caution**

- New settings are saved only if you click the **Apply** button at the bottom of the screen. The **Cancel** button cancels new settings.

## 4.2.1.2 Streaming

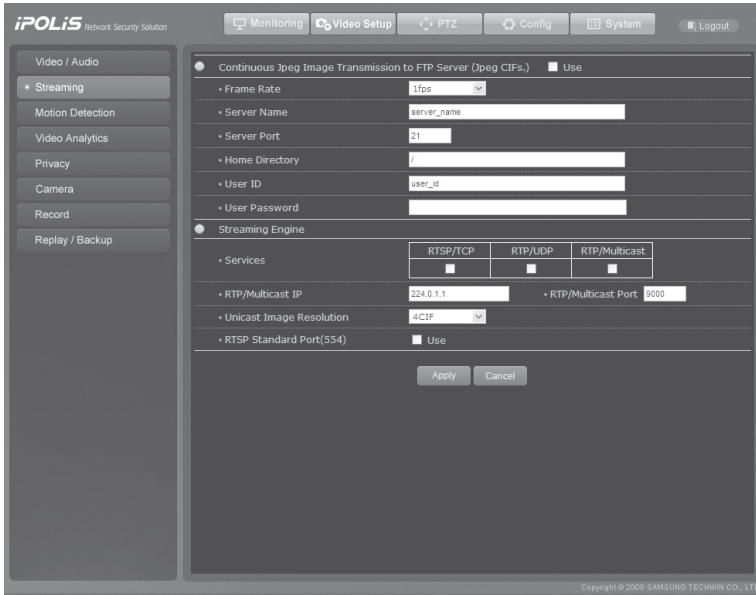

### ■ Continuous JPEG Image Transmission

Category	Description
Use	Check to use the Continuous JPEG Image Transmission option.
FrameRate	Select a number of frames per second.
Server Name	Enter the domain name or IP address of your FTP server.
Server Port	Enter the port number of your FTP server.
Home Directory	Enter a home directory in the FTP server to save data. Make sure to enter "/" to save the data directly to the FTP server's home directory.
User ID	Enter an ID to log in to the FTP server.
User Password	Enter the password for the ID that is entered above.

## Chapter 4. Using Web Viewer

### ■ Streaming Engine

Configure the RTP/RTSP streaming service.

Category		Description
Services	RTSP/TCP	Check to use RTSP/TCP.
	RTP/UDP	Check to use RTP/UDP.
	RTP/Multicast	Check to use RTP/Multicast.
RTP/Multicast IP		Enter an IP address for RTP Multicast.
RTP/Multicast Port		Enter a port number for RTP Multicast.
Unicast Image Resolution		Select a resolution for the RTSP/TCP and RTSP/UDP streaming services.
RTSP Standard Port(554)		Check to use the RTSP standard port, 554.

- Multicast RTP is effective to transfer video to multiple users as it uses a very low amount of network bandwidth.
- Multicast RTP, however, uses UDP that transfers the latest video but may also incur the risk of data loss.
- Multicast requires an authorization from the server router; multicast over the internet is not available.
- Streaming resolution for Multicast is fixed as CIF.



**Notes** Unicasting is suitable for VOD (Video on Demand) services as it does not transfer video data unless a user connects and requests data transfer.



#### **Caution**

- New settings are saved only if you click the **Apply** button at the bottom of the screen. The **Cancel** button cancels new settings.

## ■ How to Use The Streaming Engine

Please follow the instructions below to use the streaming engine.

We recommend using VLC Media Player for the streaming engine. (Version: 1.0.1 or higher)

### ○ Step 1) Set Up Streaming Page

Select a desired function on the streaming engine, and then press <Apply>.

### ○ Step 2) Run VLC Media Player

The following window appears when you open VLC media player in your computer.

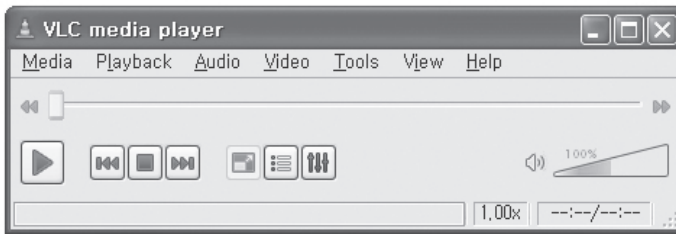

- Enter the camera ID and PW into the menu highlighted in the picture below.

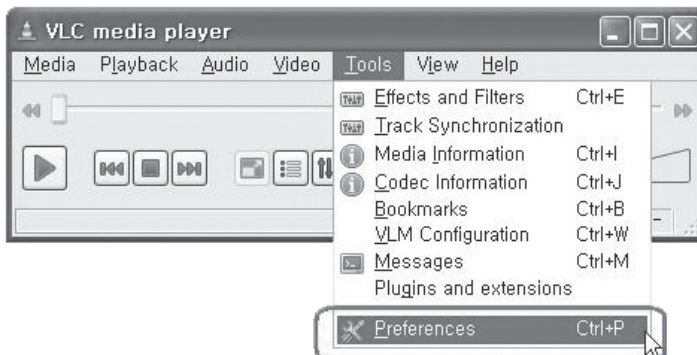

# Chapter 4. Using Web Viewer

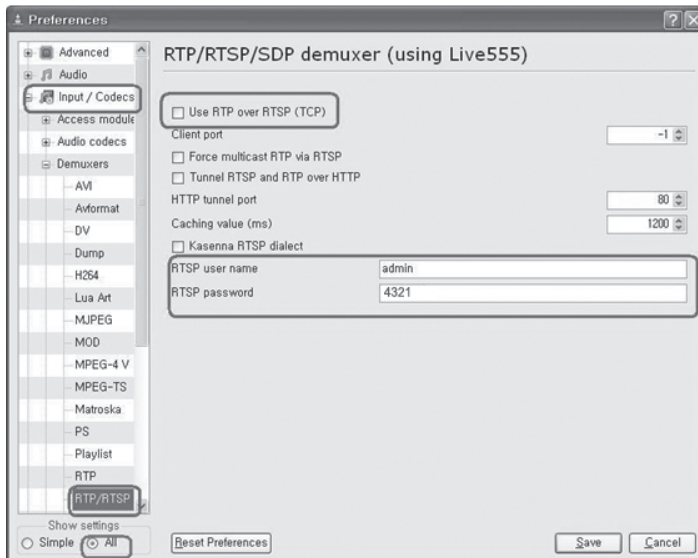
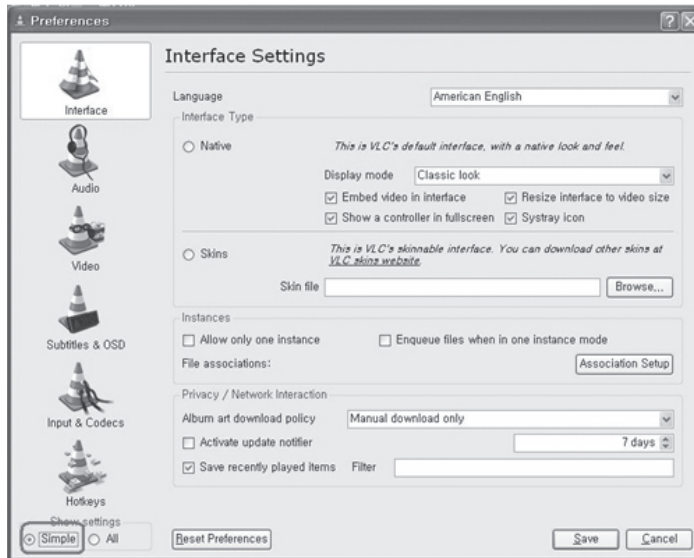



**Notes** Checking Use RTP Over RTSP (TCP) activates RTSP/TCP Connection in the Streaming Engine → Services menu. To use RTP/UDP and RTP/Multicast, do not check the box.

- In the menu bar, select Media (M), and then Open Network Stream (N).

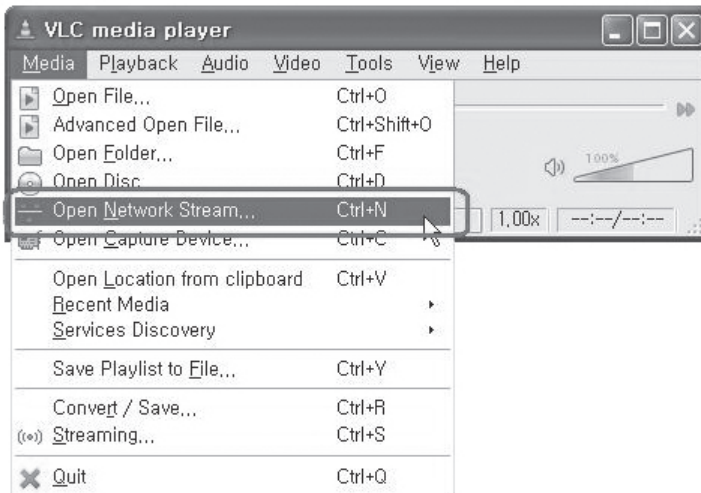

## Chapter 4. Using Web Viewer

- Depending on the type of video, enter an address similar to the examples shown in the following chart, and then click Play (P). (When using the default RTSP port number, 554, you may skip entering the port number.)

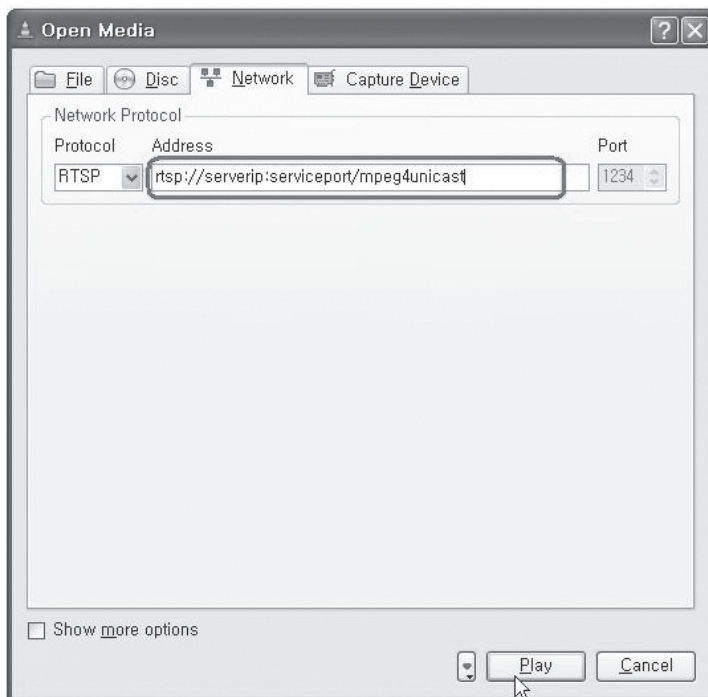

The followings are examples of addresses for network streaming.

Address	Streaming Engine Settings
rtsp://<IP>:<SERVICE PORT>/mpeg4unicast	For RTSP/TCP and RTP/UDP
rtsp://<IP>:<SERVICE PORT>/mpeg4multicast	For RTSP/Multicast



- Notes** <IP> : The current camera IP  
<Service Port> : The number of the service port +1 that is selected at the Config Setup → Network menu.  
ex) default port : 80 → <SERVICE PORT> : 81  
※ When using the default RTSP port number, 554, you may skip entering the port number.

### 4.2.1.3 Motion Detection

Configure the camera's Motion Detection operation.

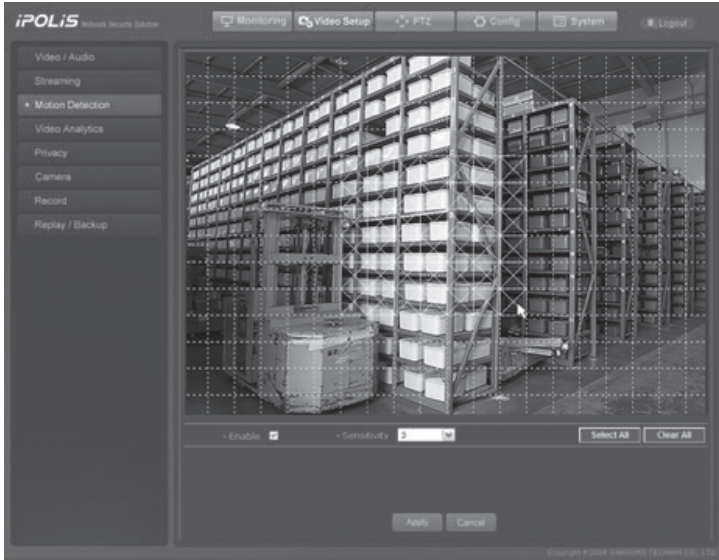

#### Notes



: Selected Area,



: Other Areas.

Category	Description
Enable	Check to enable Motion Detection.
Sensitivity	Select a sensitivity level for motion detection according to the video display settings. 5 levels are available, and 5 is the most sensitive.



#### Caution

- New settings are saved only if you click the **Apply** button at the bottom of the screen. Apply The **Cancel** button cancels new settings.

## Chapter 4. Using Web Viewer

### 4.2.1.4. Video Analytics



Category	Description
Enable	Check to enable Video Analytics.
Sensitivity	Select a sensitivity level for motion detection according to the video display settings. 5 levels are available, and 5 is the most sensitive.
Transition Time	Shows the period of time maintaining a changed screen for detection.
Reset Time	Resets the current screen to a selected point of time.

## 4.2.1.5. Privacy

For privacy protection, you can specify areas to hide. When selecting an area on the screen, the area is masked in gray.



Category	Description
Privacy zone	Indicates the number of the Privacy Zone.
Enable	Select On or Off to apply the selected Privacy Zone on the screen.
Set Privacy	Defines a selection as a Privacy Zone.
Start	Starts selecting an area.
End	Finishes selecting an area.
Privacy Limit	Select an area for which the Pan and Tilt operations of the camera are limited. Pan Limit limits the Pan operation while Tilt Limit limits Tilt.
Enable	Select On or Off to use Privacy Limit.
Set Limit	Defines a selection as a Privacy Limited area.
Start	Starts selecting a Privacy Limited area.
End	Finishes selecting a Privacy Limited area.

## Chapter 4. Using Web Viewer

When right-clicking on the screen, the following menu appears. Descriptions for each menu are as below :

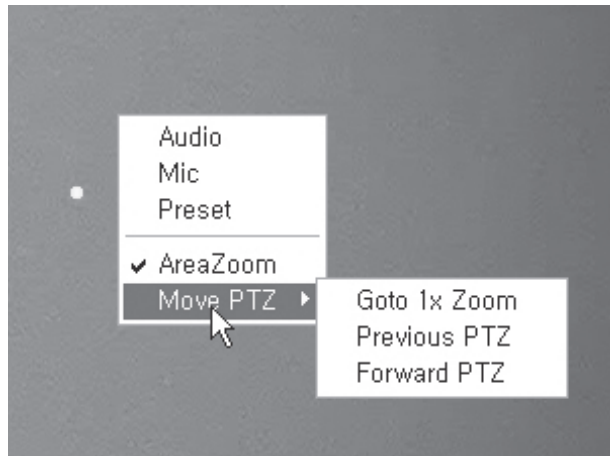

Category		Description
Audio		Turns on audio.
Mic		Use a mic.
Preset		Sets the selected area as a preset.
Area Zoom		Zooms in on a selected area.
Move PTZ	Goto 1x Zoom	Changes the current zoom power to 1x.
	Previous PTZ	Moves to the previous area and its settings.
	Forward PTZ	Moves to the next area and its settings.



### Caution

- Set Pan and Tilt range to be within 30 degree when selecting a Privacy area.

## 4.2.1.6. Camera

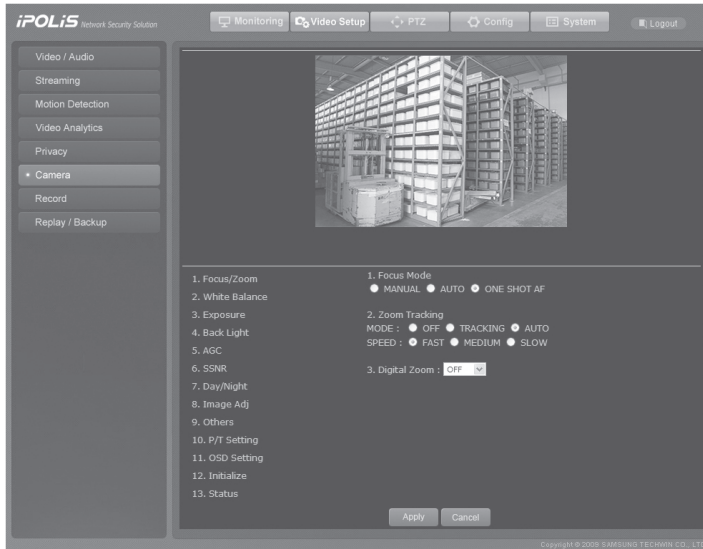

### ■ Focus / Zoom

#### ① Focus Mode

- Auto : Performs continuous autofocus.
- Manual : Changes the camera mode to Manual Focus.
- One Shot AF : Performs auto-focusing one time only immediately after the Pan/Tilt/Zoom operation.

#### ② Zoom Tracking

##### • Mode

- Auto : Performs zoom operations in the Autofocus mode.
- Tracking : Performs zoom operations in Manual Focus mode.
- Off : Disables the focus modes when zooming. (Full manual mode)

##### • SPEED

- Slow/Medium/Fast: Adjusts the zoom operation speed.

##### • Digital Zoom

Enables the maximum digital zoom. Up to 12x digital zoom can be selected to achieve a maximum combined zoom of 444x (SNP-3370) or 360x (SNP-3301).

## Chapter 4. Using Web Viewer

### ■ White Balance

#### ① Mode

The White Balance settings adjust the balance of the screen colors under different lighting conditions.

- ATW : Adjusts the screen color automatically.
- MANUAL : Enables customization of the Red and Blue gains.
- AWC : Adjusts the screen color to be optimized to the current lighting and monitor conditions. Using this setting may require a readjustment if the lighting conditions change.
- Indoor : Optimizes the screen colors automatically for indoor environments.
- Outdoor : Optimizes the screen colors automatically for outdoor environments.

### ■ Exposure

The Exposure settings are for controlling the camera's exposure meter.

#### ① Brightness : Adjusts the screen brightness. (Over 50: Brighter, Under 50: Darker)

#### ② Iris

- Auto : Automatically adjusts the exposure meter.
- Manual : Enables manual adjustment of the exposure meter.

#### ③ Shutter : Controls the camera's electronic shutter.

- ESC : Adjusts the shutter speed automatically according to the screen brightness.
- A.FLK : Select this setting when you experience picture flickering. Flickering can happen when artificial lighting frequencies clash with camera frame rates.
- Manual : Enables manual adjustment of the shutter speed.

#### ④ Sens-Up : Controls the camera's electronic shutter.

- Auto : Automatically detects light levels and maintains a clear picture at night or under low-light conditions.

### ■ Back Light

This feature is achieved by our innovative SV-IV DSP chipset. Unlike other cameras, this SNP-3370/3301 enables you to see clearly both an object and the background, even when the object is in extreme backlight .

#### ① Back Light Mode :

- Off : Disables the Backlight mode.
- WDR : Use the WDR (Wide Dynamic Range) mode.
  - WDR Setting : Three WDR sensitivity levels are available: Low, Medium, and High. Note that the higher the sensitivity level, the lower the contrast in the light and dark areas becomes.
  - WDR Level : Adjusts the overall brightness of the screen in WDR mode.



### Caution

- WDR is disabled if the shutter is in Manual mode.
- During WDR operation, noise, discoloration, spots, and snow may occur depending on lighting conditions. If they occur, stop using WDR.
- When selecting WDR, AGC Manual is disabled.

- USER : Select an area for which to use the Backlight feature.
  - WINDOW ON : Select to use the Area Selection window.
  - DIRECTION : ALL – Moves the Area Selection window in a desired direction.  
Detail – Adjusts the shape of the Area Selection window.

- HLC : Activates the Highlight Compensation mode.

The HLC settings selectively eliminate highlights in a restricted environment such as the entrance to an apartment parking lot or gas station, and is useful to detect small objects like car license plates. HLC is disabled during the daytime. While monitoring nighttime car traffic, if car headlamps reflect too brightly on the screen, the camera automatically eliminates the headlamp lights and adjusts the colors of the license plate accordingly.

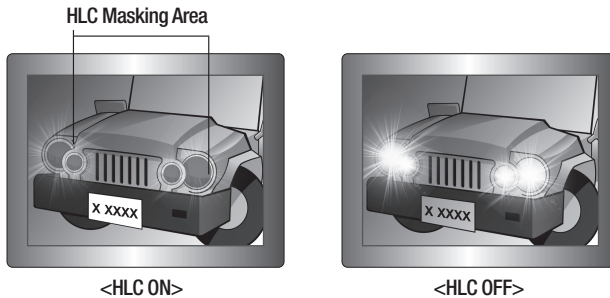

- Adjusts the HLC sensitivity level.
- Color : Adjusts the mask color on the highlighted area.



### Caution

- Even if HLC is on, car license plates may not be detectable depending on the location and angle of the camera as well as the lighting conditions.

### ■ AGC (Auto Gain Control)

AGC (Automatic Gain Control) adjusts the camera's gain control and the screen brightness if the camera has captured an object under low-light conditions.

## Chapter 4. Using Web Viewer

### ■ SSNR (Samsung Super Noise Reduction)

Reduces background noise in low-light images.

- OFF : Disables the noise reduction function.
- LOW : Reduces only a small amount of noise, but generates almost no afterimage.
- Medium : The most commonly used mode. Reduces a suitable amount of noise while generating only a faint afterimage.
- HIGH : Reduces noise significantly, but generates obvious afterimages.



#### Caution

- SSNR is disabled when the AGC mode is turned off.

### ■ Day & Night Mode (DAY/NIGHT)

This feature changes the mode of the camera between Color and B/W (Black and White).

#### ① MODE :

- AUTO : Operates in Color mode most of the time, and switches to B/W mode if a low light level is detected during nighttime.
- COLOR : Always displays video in color.
- B&W : Always displays video in black and white.

#### ② Duration : The camera's light sensitivity is adjustable as in the chart below. The camera's ambient light switching performance may vary depending on its environment.

	Color → B&W	B&W → Color
Early	2.5 lux	4 lux
Late	0.8 lux	6 lux

#### ③ Dwell Time : You can select day/night switching delay time from.



#### Caution

- Auto mode is disabled when AGC is turned off. This function is only available when Color or B/W mode is selected.
- Using B/W mode under sunlight or in halogen lighting may decrease the focusing performance.

### ■ Image Adj (DAY/NIGHT)

- ① Sharpness : Sharpens image outlines.
- ② Color : Adjusts the color density of an image.



### **Caution**

- This function uses the digital zoom; it causes degradation in video quality.
- The stabilizer does not activate at low light levels.
- The stabilizer does not activate when the camera is capturing an area with a monotonous pattern, such as the sky or a white wall.

#### ■ Others

- ① Stabilizer : The stabilizer compensates for camera vibration as a result of wind and other causes.
- ② Dome Cover  
These settings are to optimize the camera's focused object position according to the dome cover type.
  - Inner : Select when using the camera without a housing. (Factory Release mode)
  - Outer : Select when using this camera with a housing.
  - None : Select when using the camera without the dome cover.

#### ■ P/T Setting

- ① Prop. P/T  
This commands the camera to change the Pan and Tilt speed automatically according to the current zoom position. Moving the joystick clockwise (Tele) slows down and counterclockwise (Wide) accelerates the Pan and Tilt speed, allowing detailed adjustments. Turning this "OFF" executes the optical 1x zoom speed regardless of the zoom position.
- ② Digital Flip  
Digital Flip is useful to monitor a moving object or a person passing directly under the camera.  
When an object or a person passes directly under the camera, the camera's tilt angle automatically adjusts and follows the object or person over 100 degrees to the other side of the tilt area without panning. The screen inversion occurs at 100 degrees or higher and is digitally adjusted.
- ③ Image Hold  
While the camera is operating in the Group or Tour Search mode, this feature pauses the monitoring screen at a previous preset until the camera reaches the next preset location. This is useful to help the screen observer maintain a constant watch and to monitor multiple locations within a network.
- ④ Power On Resume  
This is useful when the power is disconnected and reconnected due to power failures or other power interruptions.

## Chapter 4. Using Web Viewer

### ⑤ Turbo Enable

This function accelerates the speed of the PTZ operations in proportion to the period for which the PTZ button is pressed.

For example, hitting the PTZ button once activates the operation at slow speed, but the speed increases so long as you are holding down the button.

### ■ OSD Setting

- ① Camera ID : Displays or hides the ID of the current camera on the screen.
- ② Sequence Status : Displays or hides the status of a sequence action that is in progress.
- ③ PTZ Position : Displays or hides the status of the Pan, Tilt, and Zoom operation that is in progress.

### ■ Initialize

- ① Camera Default : Use this function when replacing the camera's zoom module; uploads the settings of the previous module to a new module. Make sure to keep the camera turned off while replacing the module and then use this function.
- ② Auto Refresh : Optimizes the electronic circuits and components of the camera on a regular basis. This function is useful to maintain and restore the current settings of the camera. Use it after the camera has been facing a strong light source directly for a long time, or when the settings have changed after the camera has repeatedly rotated to capture the video of an area over a long period.
  - OFF, 1~7 Days : OFF disables Auto Refresh while 1 to 7 Days performs it at selected intervals.
  - ※ Auto Refresh takes approximately 10 seconds to finish. If Auto Refresh activates in the middle of a sequence action, the camera pauses the sequence action and performs an Auto Refresh, then resumes the sequence action once the refresh is complete.

### ■ Status

Displays the settings and version of the dome camera.

- Cam Model : Indicates the model name of the camera.
- Protocol : Indicates the type of protocol that is used for the camera.
- Duplex : Supports one- and two-way communications.
- Baud Rate : Displays the selected baud rate.

- Data Bits : Displays selected data bits.
- Stop Bits : Displays selected stop bits.



### Caution

- New settings are saved only if you click the **Apply** button at the bottom of the screen. The **Cancel** button cancels new settings.

## 4.2.1.7. Record

Use this menu to save image data to an SD memory card.

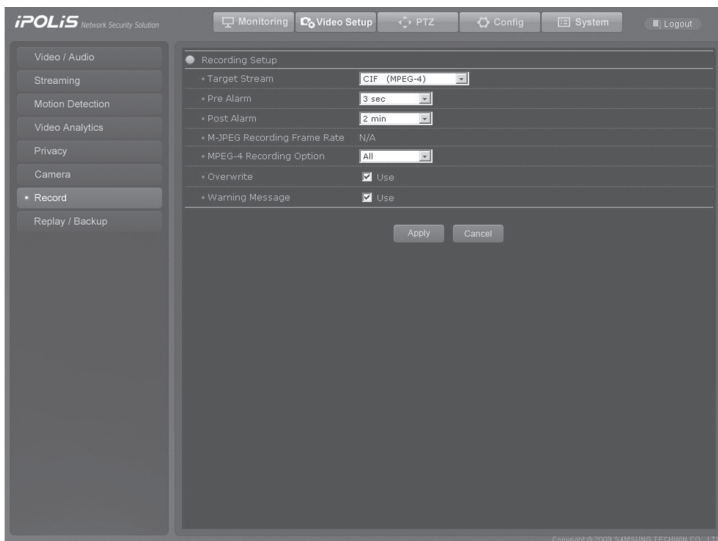

### ■ Record Setup

Category	Description
Target Stream	Select a stream to save.
Pre alarm	Select a time to start saving an event prior to its occurrence.
Post alarm	Select a time to finish saving an event after its occurrence.
M-JPEG Recording Frame Rate	Selecting ALL saves all frames while 1fps saves only 1 frame per second.
H.264, MPEG-4 Recording Option	Selecting ALL saves all frames while 1fps saves only 1 frame per second.
Overwrite	Deletes the oldest file and saves a new file when no free space remains in an inserted memory device.
Warning Message	If an inserted SD memory card is not working or becomes full—because the Overwrite option is not used, selecting this option displays a warning message on the screen.

## Chapter 4. Using Web Viewer



### Caution

- If Overwrite is not checked and the SD memory card is full, the camera stops recording data.
- This camera is compatible only with SD cards; MMC cannot be used. Do not insert an SD card the wrong way round; it may damage the slot.
- Only 1GB to 2GB SD and 4GB SDHC cards are supported.
- We recommend the FAT32 format.
- Please turn off the camera before removing the SD card; the data may be damaged otherwise.
- If using 4CIF resolution, the camera saves only 1fps for both H.264, MPEG-4 and M-JPEG.

### 4.2.1.8. Replay / Backup

Configure this menu to record Motion Detection and Sensor events upon their occurrence. You can also watch a recorded event using this menu.

Ch	Event	Time
1	MD	2009/08/21 13:53:47
1	MD	2009/08/21 13:53:43
1	MD	2009/08/21 05:24:56
1	MD	2009/08/21 05:24:52
1	MD	2009/08/18 13:52:06
1	MD	2009/08/18 13:52:02
1	MD	2009/08/18 13:51:58
1	MD	2009/08/18 13:51:55
1	MD	2009/08/18 13:51:52
1	MD	2009/08/18 13:51:47
1	MD	2009/08/18 13:51:40
1	MD	2009/08/18 13:51:37
1	MD	2009/08/18 13:51:31
1	MD	2009/08/18 13:51:26
1	MD	2009/08/18 13:51:13



### Caution

- For the Backup operation, only 1 file can be backed up at a time.

Category		Description
Storage Information	Storage Size	Total: Indicates the total capacity of an SD memory card. Free: Indicates the free space of an SD memory card.
	Total Clips	Event Type: Displays the number of available files per event type: MD (Motion Detection), SD (Sensor Detection), and VA (Video Analytics).
Replay/backup	Event Type	When selecting MD or Sensor, displays only the selected type of event files when searched.
	Search	Lists files of a selected event type.
>>, >		Moves to a page that contains a list of older files. > : Moves to the next page. >> : Moves to the last page.
<<, <		Moves to a page that contains a list of newer files. < : Moves to the next page. << : Moves to the last page.
Goto		Enter a page number to go directly to it.
		Plays a saved video.
		Stops the video.
		Pauses the video.
		Save the video image as a JPEG file.
Backup		Saves the video to your computer.
		Downloads SLiM Player in your computer.

## 4.2.2 PTZ Page

The following page appears when selecting PTZ at the top of the screen.

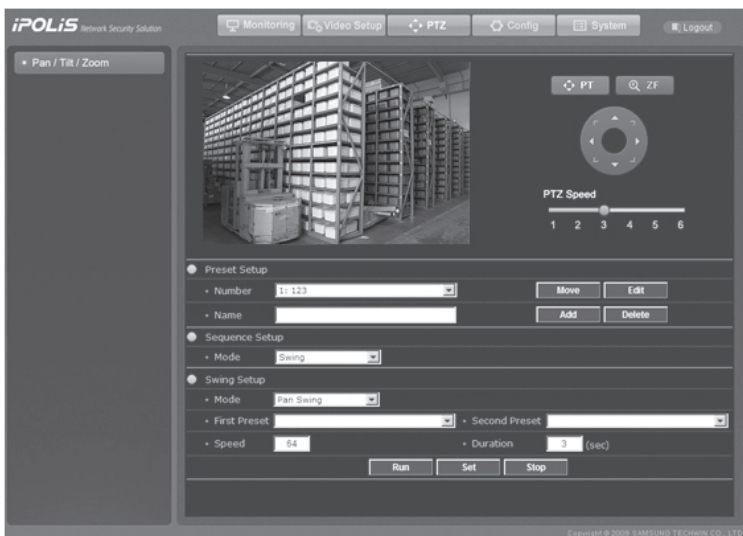

## Chapter 4. Using Web Viewer

### ■ Preset Setup

To save a desired location for the Pan/Tilt or Zoom/Focus operation along with detailed camera settings for the location, configure the following options.

Category	Description
Number	Select a number to identify a preset. (Preset numbers 1 to 255 are available.)
Name	Name a preset.
Move	Moves to a selected preset when its number is selected.
Edit	Enables detailed camera settings to be configured for a preset.
Add	Saves a preset; move to a desired location for the Pan/Tilt or Zoom/Focus operation, enter a preset number and name, and then press the Add button to save the location as a preset.
Delete	Deletes an existing preset; select a preset number, and then press the Delete button.



### Caution

- New settings are saved only if you click the **Add** button on the right of the screen. To configure detailed camera settings for a preset, select a preset number, and then move the camera to the preset before pressing the **Edit** button.

### ■ Sequence Setup

You can configure detailed sequence settings for each camera mode. Available camera modes are Swing, Group, Tour, Trace, and Auto Run, and they are described in the chart below.

Category	Description
Swing	Commands the camera to move between 2 selected presets, monitoring the route.
Group	Recalls groups of multiple preset locations consecutively. A group can contain up to 255 presets.
Tour	Recalls groups of presets consecutively in an orderly manner. Up to 6 groups can be listed for this function.
Trace & Auto Run	Trace saves and reactivates patterns of custom camera movements. Up to 4 movement patterns can be memorized. Auto Run commands the camera to automatically perform a preset sequence action if no command has been entered via the controller for a while.

## 4.2.2.1. Swing

### ■ Swing Setup

Category		Description
Sequence Setup	Mode	3 modes are available: Pan Swing, Tilt Swing, and P&T Swing.
	Pan Swing	Activates only the Pan operation for Swing monitoring.
	Tilt Swing	Activates only the Tilt operation for Swing monitoring.
	P&T Swing	Activates both the Pan and Tilt operations for Swing monitoring.
First Preset		Select the first preset for a route consisting of 2 presets.
Second Preset		Select the second preset for a route consisting of 2 presets.
Speed		Select the camera's movement speed between the first and second presets. (Levels 1 to 64 are available.)
DWT(Dwell Time)		Select the number of seconds to keep the PTZ camera on a preset location for monitoring.



### Caution

- New settings are saved only if you click the **Set** button at the bottom of the screen. The **Run** button operates the camera with the selected settings.

## Chapter 4. Using Web Viewer

### 4.2.2.2. Group

No.	Preset	Speed	Dwell
-----	--------	-------	-------

#### ■ Group Setup

Category	Description
Group No.	Information on a maximum of 6 groups can be saved.
Preset No.	Select a preset number to add the preset to a selected group.
Speed	Select the camera speed to move between presets. (Levels 1 to 64 are available.)
DWT(Dwell Time)	Select the number of seconds to keep the PTZ camera on a preset location for monitoring.



#### Caution

- A preset is added in the Preset No. if you click the **Add** button at the bottom of the screen. The **Clear** button deletes all the presets in a selected group. To apply new settings, please make sure to press the **Set** button.

### 4.2.2.3. Tour

The screenshot shows a web interface for 'Sequence Setup'. Under the 'Tour Setup' section, there is a 'Mode' dropdown set to 'Tour'. Below it, 'Group No.' is set to '1' and 'DWT' is set to '3 (sec)'. There are 'Run' and 'Stop' buttons under 'Execute'. At the bottom, there are 'Add', 'Set', and 'Clear' buttons. On the right, a table with columns 'NO.', 'GROUP', and 'DWT' is visible, currently empty.



#### Caution

- A preset is added in the Preset No. if you click the **Add** button at the bottom of the screen. The **Clear** button deletes all the Group No. in a selected the Tour No. To apply new settings, please make sure to press the **Set** button.

#### ■ Tour Setup

Category	Description
Group No.	Up to 6 group numbers can be saved.
DWT(Dwell Time)	Select the number of seconds to keep the PTZ camera on the last preset of a group before moving to the next group.

## Chapter 4. Using Web Viewer

### 4.2.2.4. Trace & Auto Run

The screenshot shows a web interface for PTZ Trace Setup and Auto Run Setup. The PTZ Trace Setup section includes a Mode dropdown menu set to 'Trace & Auto Run', a Trace No. dropdown menu set to '1', and three buttons: 'Replay', 'Memorize', and 'Stop'. The Auto Run Setup section includes a Mode dropdown menu set to 'OFF', a Time dropdown menu set to '30' with a unit dropdown set to 'SEC', a Number input field set to '1', a Tilt Angle input field set to '25', and a 'Set' button.

#### ■ PTZ Trace Setup

Category	Description
Trace No.	Up to 4 traces can be saved.
Replay	Replays a route saved by the Trace function.
Memorize	Pressing the Memorize button starts saving the route of the Pant/Tilt or Zoom/Focus operation automatically.
Stop	During Replay mode, press the Stop button to abort the Trace operation. During Memorize mode, press the Stop button to finish memorizing a route.

#### ■ Auto Run Setup

Category	Description
Mode	8 modes are available: OFF, HOME, Preset, Swing, Group, Tour, Trace, and A.Pan.
Time	Select time to activate Auto Run. (1 to 60 seconds and 1 to 60 minutes are available.)
Number	In the HOME and Preset modes, Number is used to set up preset numbers. In the Swing mode, Number is used to set up the Pan, Swing, and P&T modes. In the Group and Trace modes, Number is used to set up groups and trace numbers. In the A.Pan mode, Number is used to adjust the Pan speed.
Tilt Angle	Available only in the A.Pan mode; enables a tilt angle to be set up for the Pan operation.
Speed	Available only in the A.Pan mode; enables to set the Pan operation speed.



#### **Caution**

- Pressing the Set, Clear, or Stop button aborts sequence action, for example, PTZ operations of the camera like Preset, Group, Tour, etc.

### 4.2.3. Config Page

The following page appears when selecting  at the top of the screen. Buttons on the left side of the screen move to the relevant menu page.

#### 4.2.3.1. Network

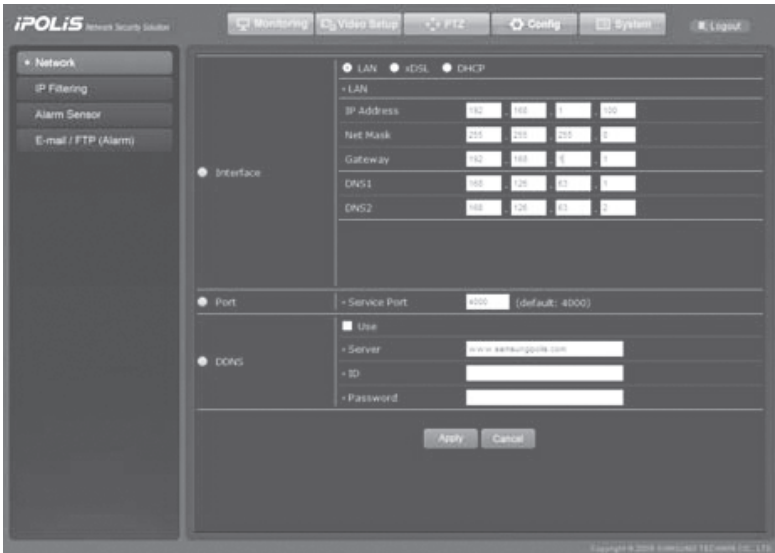

#### ■ Interface

LAN, xDSL, and DHCP options are available depending on your network environment.

Category	Description
LAN	If the camera uses a static IP, enter the network information of the camera.
xDSL	Enter the ID and password of your xDSL server.
DHCP	Select this option when the camera receives an IP from a DHCP server.

## Chapter 4. Using Web Viewer

### ■ Port

Enter a port number to connect the camera to the network.

### ■ DDNS

Check to use the DDNS service.

Category	Description
Use	Check to use the DDNS service.
Server	Enter a DDNS server address; our DDNS server is at <a href="http://www.samsungipolis.com">www.samsungipolis.com</a> .
ID	Enter the ID (domain name) of the camera that is registered to the DDNS server.
Password	Enter the password for the ID entered above.

### ■ How to Use DDNS

Our DDNS server registration procedures are as follow:

- Step 1) Sign up for membership on the iPOLiS website at:  
[www.samsungipolis.com](http://www.samsungipolis.com)

HOME | LOGIN | SIGNUP | SITEMAP | KOREAN | ENGLISH

**iPOLiS** WHAT IS IPOLIS PRODUCT DDNS SERVICE SUPPORT MY IPOLIS

**iPOLiS**  
SAMSUNG NETWORK SECURITY SOLUTION

Go to the list of registered IPs

SNP-3750/3350 SNR-6400/3200 SNC-1300

**SNP-3750/3350**  
3703x HIGH-RESOLUTION NETWORK PTZ ICRIC CAMERA  
• MPEG-4/JPEG dual codec  
• Maximum 3703x optical zoom (3.5-115.5mm)  
• Real-time multi-streaming  
• SD memory card, Various Exclusive Accessories

**SAMSUNG CCTV SYSTEM**  
The frontier in digital image security!

**DOWNLOAD CENTER**  
We will provide you with information about the products available.

**REMOTE SERVICE**  
One click remote call Service

PRIVACY / LEGAL NOTICE / CONTACT US | SAMSUNG TECHWIN | FAMILY SITE | Quick Link

Pic 4-1. iPOLiS Website

**Welcome to IPOLIS**

We provide real-time online video service for IPOLIS products through this web browser.  
We recommend strongly every purchaser of IPOLIS products sign up for IPOLIS online.

**LEGAL NOTICE**

Legal Notice

NO. 1

NO. 2

 Agree

NEXT

Pic 4-2. Membership Signup : Agree to the Terms of Service

SIGNUP + My IPOLIS > Signup

**Welcome to IPOLIS**  
We provide real-time online video service for IPOLIS products through this web browser.  
We recommend strongly every purchaser of IPOLIS products sign up for IPOLIS online.

**Manage your account**

+ ID  AVAILABILITY

+ PASSWORD  \* Create password of 6 to 12 characters in length containing letters A-Z or numbers 0-9

+ PASSWORD Check

+ NAME

+ JOB

+ E-mail

+ ADDRESS  POSTAL CODE

+ TEL

+ MOBILE PHONE  -  -

**Manage company account**

+ COMPANY

+ TEL

+ FAX

+ ADDRESS  POSTAL CODE

SIGN UP BACK

Pic 4-3. Membership Signup : Enter Personal and Company Information

## Chapter 4. Using Web Viewer

- Step 2) Log in to the website, and then register your camera.

WELCOME to IPOLIS !



The login form features a 'Login' icon on the left. It includes two input fields: 'ID' with the value 'andy' and 'PASSWORD' with masked characters. A 'LOGIN >' button is positioned to the right of the password field. Below the input fields, there are two sections: 'MEMBER JOIN' with a 'SIGN UP >' button, and 'ID/PW SEARCH' with an 'ID/PW SEARCH >' button. A message 'User ID and password don't match' is displayed below the search button.

Pic 4-4. Login

Product List My IPOLIS > Product List

Current product list is displayed.  
If wanted product is not in the list, click 'Product Registration' at the bottom.

NO	ID	Model	Location	Status	View	Information	Management
1	andy3300	SNP-3300	AMBASSADOR HOTEL	OFF	<a href="#">View</a>	<a href="#">Check</a>	<a href="#">Edit</a> <a href="#">Delete</a>
2	andy550	SNP-3750	Lab	OFF	<a href="#">View</a>	<a href="#">Check</a>	<a href="#">Edit</a> <a href="#">Delete</a>

[Product Registration](#)

Pic 4-5. Registered Device List

**Product Registration** My IPOLIS > Product Registration

---

**Mandatory Information**

http://www.samsungipolis.com/

**ID(domain) \*** 

- Create an ID of 4 to 12 characters in length containing letters A-Z or numbers 0-9.
- You should have exactly same ID with the item (product) ID to log on DDNS online service.
- Make sure the correct ID and click the item (product) ID.
- You may not able to change the initial domain name.

**PASSWORD \***

**PASSWORD CHECK \***

**CLASSIFICATION \***  - Choose product category.

**MODEL NUMBER \***  - Choose product model.

**LOCATION \*** 

- Determine the location to install the system (or camera).
- Designate the installation location within 10 alphabet letters.

**DESCRIPTION** 

- Describe product for management purpose.

Pic 4-6. Register Camera (Check the availability for your desired domain name.)

**ipolis** HOME | SITEMAP | **KOREAN** | ENGLISH

WHAT IS IPOLIS    PRODUCT    DDNS SERVICE    SUPPORT    MY IPOLIS

---

Samsung Network Surveillance system  
*An Idea. Anywhere. In Real-time.*

**MY IPOLIS**

List of registered IPs

- 
- 
-

**Product List** My IPOLIS > Product List

Current product list is displayed.  
If wanted product is not in the list, click 'Product Registration' at the bottom.

NO	ID	Model	Location	Status	View	Information	Management
1	andy1000	SNP-1000	The RITZ-CARITON Seoul	OFF	<input type="button" value="View"/>	<input type="button" value="Check"/>	<input type="button" value="Edit"/> <input type="button" value="Delete"/>
2	andy9900	SNP-3900	AMBASSADOR HOTEL	OFF	<input type="button" value="View"/>	<input type="button" value="Check"/>	<input type="button" value="Edit"/> <input type="button" value="Delete"/>
3	andy9900	SNP-3750	Lab	OFF	<input type="button" value="View"/>	<input type="button" value="Check"/>	<input type="button" value="Edit"/> <input type="button" value="Delete"/>

PRIVACY / LEGAL NOTICE / CONTACT US    **SAMSUNG TECHNET**    FAMILY SITE   

Pic 4-7. Device List (The camera will be listed if it is successfully registered.)

## Chapter 4. Using Web Viewer

- Step 3) Configure the camera with the DDNS information.
  - Select [Config → Network] on the network camera webpage.
  - Click on Use under the DDNS options to enable the service, and then enter the address of the DDNS server.
  - Enter the ID (Domain Name) and password used to register the camera on the iPOLiS website into ID and PW.

The screenshot shows the iPOLiS Network Security Solution web interface. The top navigation bar includes 'Monitoring', 'Video Setup', 'PTZ', 'Config', 'System', and 'Logout'. The left sidebar has 'Network' selected, with sub-items 'IP Filtering', 'Alarm Sensor', and 'E-mail / FTP (Alarm)'. The main content area is titled 'Interface' and has three radio buttons: 'LAN' (selected), 'xDSL', and 'DHCP'. Under the 'LAN' section, there are input fields for IP Address (192.168.23.55), Net Mask (255.255.255.0), Gateway (192.168.23.1), DNS1 (168.126.83.1), and DNS2 (168.126.83.2). Below this is the 'Port' section with a 'Service Port' field set to 85 (default: 80). The 'DDNS' section has a 'Use' checkbox checked, a 'Server' field with 'www.samsungpolis.com', and empty fields for 'ID' and 'Password'. 'Apply' and 'Cancel' buttons are at the bottom. A copyright notice 'Copyright © 2006 SAMSUNG TECHWIN CO., LTD.' is visible at the bottom right.

Now the SNP-3370/3301 is set up with the DDNS service.

- Step 4) Log in to the iPOLiS website and check the connection status of the camera in your Product List.

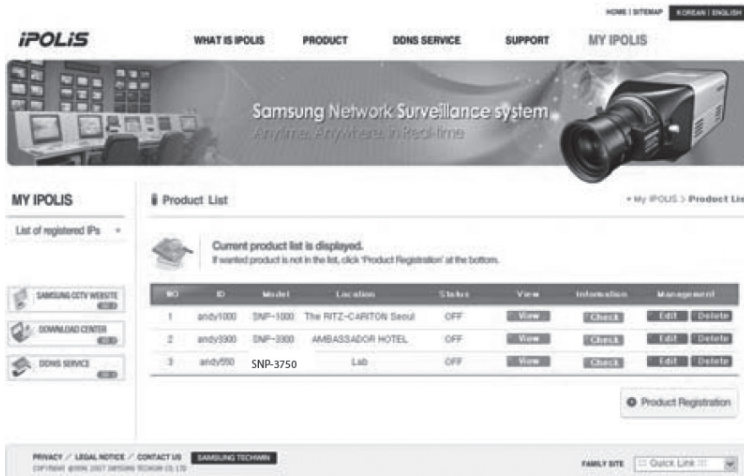

Pic 4-8. Product List

Press <Check> next to the “Product Information” to check the information for a connected device.

### Product Information

• ID(domain)	test3750
• PRODUCT	IP Camera
• MODEL NUMBER	SNP-3750
• CLASSIFICATION	Shop security
• LOCATION	Laboratory
• REGISTRATION DATE	2009-10-13
• MAC ADDRESS	

**×** CLOSE

Pic 4-9. Product Information

## Chapter 4. Using Web Viewer

Click the <Shortcut> button under “View Video” to move to the login page of a selected product.

The <Modify> and <Delete> buttons under “Product Management” are to modify and delete the information for a device that is registered on your Product List. They move to corresponding pages, however, only if you enter the correct password.

The “Product ID (Domain)” cannot be modified; you must first delete the current Product ID and then create a new one.

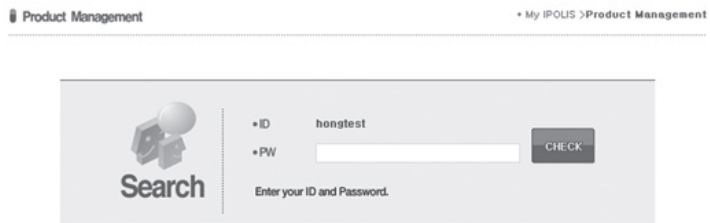

Product Management My IPOLIS > Product Management

Search

ID hongtest

PW

CHECK

Enter your ID and Password.

Pic 4-10. Delete/Modify

### 4.2.3.2. IP Filtering

You can allow or deny certain IPs.



Category	Description
IP filtering	Check on Use to enable IP Filtering.
Default policy	Determines action on an IP displayed in the Filtering Rules pane. Allow: Allows connections for the IP. Deny: Rejects connections for the IP.
Filtering Rules	Use : Activates the Default Policy for an IP next to the checkbox; check to apply the policy to the IP. IP Range: Indicates a range of IPs to which to apply IP Filtering. e.g.) 192.168.30.4 ~ 100 Apply IP Filtering to IPs from 192.168.30.4 to 192.168.30.100.



#### Caution

- New settings are saved only if you click the **Apply** button at the bottom of the screen. The **Cancel** button cancels new settings.

# Chapter 4. Using Web Viewer

## 4.2.3.3. Alarm Sensor

Configure the options to use the Alarm services by attaching a sensor to the camera.



### ◇Digital In(Sensor) Setup

Category	Description
Use.	Check to use a sensor.
Type	"Normal Open" and "Normal Close" are available choices when selecting the type for a connected sensor.

※ S1: Sensor 1, S2: Sensor 2, S3: Sensor 3, S4: Sensor 4

### ◇Digital Out(Relay/Alarm) Setup

Category	Description
Relay	Select a digital output (Relay1 or Relay2) when certain events are detected: sensor (S1~4), motion detection (MD), or video analytics(VA). For Dur (Duration), select a duration for which to activate a selected relay upon the occurrence of an event.
Sequence	Mode
	NUM
	FTP
	Mail
Recording	
FTP	In the Preset mode, Number is used to set up preset numbers.
FTP	Check to transfer information about certain events to your FTP server: sensor (Sensor 1 ~4), motion detection (MD), or video analytics(VA).

E-mail	Check to send out information about certain events via e-mail: sensor (Sensor 1~4), motion detection (MD), or video analytics(VA).
Recording	Check to save the video file of certain events to an SD memory card: sensor (Sensor 1~4), motion detection (MD), or video analytics(VA).

#### ◇Aux Setup

Category	Description
Duration	Select a duration for which to activate a connected Aux.



#### **Caution**

- New settings are saved only if you click the **Apply** button at the bottom of the screen. The **Cancel** button cancels new settings.

## Chapter 4. Using Web Viewer

### 4.2.3.4. E-mail-FTP (Alarm)

Enter the information for your FTP server and e-mail address to transfer data to when the alarm activates.

The screenshot shows the 'E-mail / FTP (Alarm)' configuration page in the iPOLIS Network Security Solution web interface. The page is divided into two main sections: 'FTP Setup' and 'E-mail Setup'. The 'FTP Setup' section includes fields for 'Server Name', 'Server Port', 'Home Directory', 'User ID', and 'User Password'. The 'E-mail Setup' section includes fields for 'Recipient E-mail Address 1', 'Recipient E-mail Address 2', 'SMTP Server Name', 'Authentication' (checked), 'ID', 'PW', 'Mail Subject', and 'Mail Body'. The 'Mail Subject' and 'Mail Body' fields have '(English Only)' next to them. There are 'Apply' and 'Cancel' buttons at the bottom of the form.

#### ■ E-mail/FTP Setup

Enter the information for your FTP server and e-mail address to transfer data to when the alarm activates.

Category	Description	
FTP	Server Name	Enter the domain name or IP address of your FTP server.
	Server Port	Enter the port number of your FTP server.
	Home Directory	Enter a home directory in the FTP server to save data. Make sure to enter "/" to save the data directly to the FTP server's home directory.
	User ID	Enter an ID to log in to the FTP server.
	User Password	Enter the password for the ID that is entered above.

E-mail	Recipient E-mail Address 1 Recipient E-mail Address 2		Enter a maximum of 2 e-mail addresses to transfer data to when the alarm activates.
	SMTP Server Name		If you use an e-mail server, enter the name of the e-mail SMTP server.
	Authentication	Use	Check to use an e-mail server; it requires an ID and password.
		ID	Enter an ID to connect to your e-mail server.
		Password	Enter the password for the ID that is entered above.
	Mail Subject		Enter the subject for an e-mail.
Mail Body		Enter contents for the e-mail.	



**Notes** Upon the occurrence of an event, a JPEG image is sent via e-mail or uploaded to the FTP server.



**Caution**

- New settings are saved only if you click the **Apply** button at the bottom of the screen. The **Cancel** button cancels new settings.
- These settings do not apply to the Continuous Jpeg Image Transmission to FTP Server option at the Video Setup → Streaming menu.

# Chapter 4. Using Web Viewer

## 4.2.4. System

The following page appears when selecting **System** at the top of the screen. Buttons on the left side of the screen move to a relevant menu page.

### 4.2.4.1. Product Info

The screenshot shows the iPOLiS Network Security Solution web interface. At the top, there is a navigation bar with tabs for Monitoring, Video Setup, PTZ, Config, System (selected), and Logout. On the left side, there is a sidebar menu with options: Product Info (selected), User, Time, Log message, and Upgrade / Reboot. The main content area displays the Product Info configuration page with the following fields:

- Model: SNP-3370
- Mac Address: 00:09:18:FF:01:45
- Device Name: hgfbjh (English only)
- Channel Name: 7654467 (English Only)
- Location: location
- Description: description
- Memo: 메모

At the bottom of the form, there are 'Apply' and 'Cancel' buttons. The footer of the page reads 'Copyright © 2009 SAMSUNG TECHWIN CO., LTD.'

#### ■ Product Info

Category	Description
Model	Displays the model name of the camera.
MAC Address	Displays the MAC address of the camera.
Device Name	Name the camera to distinguish it when using multiple cameras. (English Only)
Channel Name	Name the channel 1. When playing multiple video feeds on the screen using a multi-channel device such as a video recorder, naming a channel helps you to distinguish it from others. (English Only)
Location	Enter the installed location for the camera.
Description	Add a description for the camera.
Memo	Memo



### Caution

- New settings are saved only if you click **Apply** button at the bottom of the screen. The **Cancel** button cancels new settings.

## 4.2.4.2. User

You can change the password of the administrator ID and configure user accounts on this page.

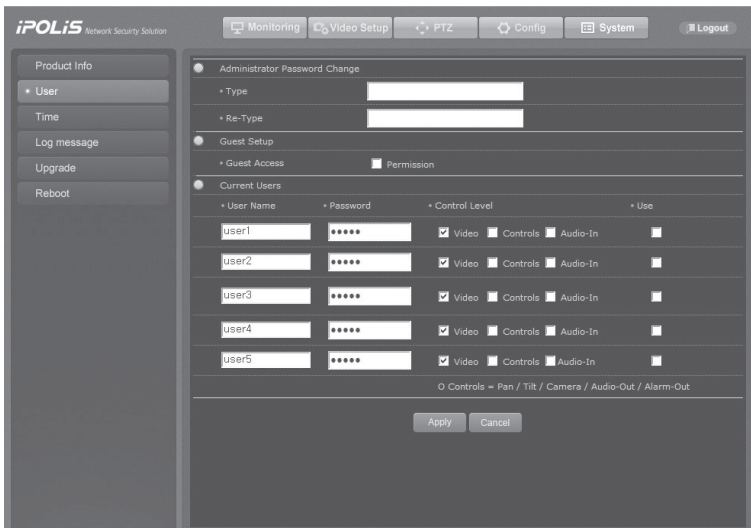

Category	Description
Administrator Password Change	Change the password for the administrator account.
Guest Setup	Check on or off to allow guest access to the main viewer; enable or disable the Guest Access button.
Current User	You can add and delete users, and configure permissions for each user.

### ■ User Permissions

Available user permissions in the [Current User] menu are as follows.

## Chapter 4. Using Web Viewer

Category	Description
Video	Allows using video-related options: compression and resolution.
Control	Allow outputting audio, alarms, and controlling the camera PTZ operation.
Audio	Allows inputting audio.
Use	Check to activate an account. (Unchecked users are not allowed to log in.)

- e.g.1) To restrict a user from controlling the camera: uncheck Control.

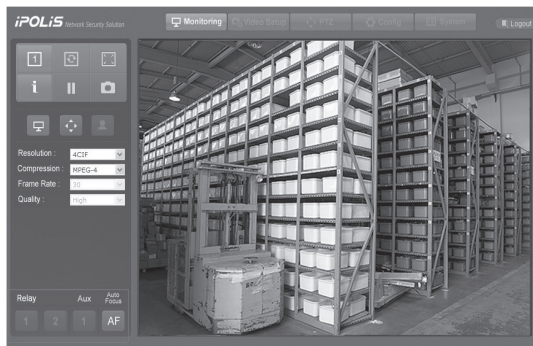

※ The Pan, Tilt, Zoom, Audio, and Alarm icons are grayed out and disabled.

- e.g.2) Restrict a user from using video-related options: uncheck Video.

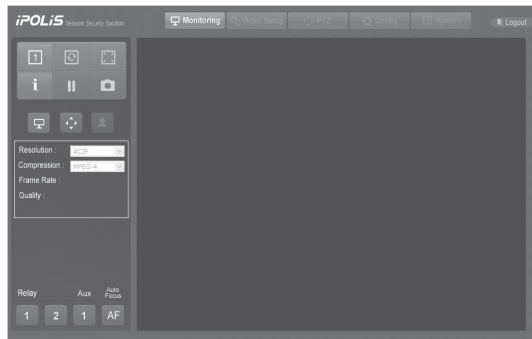

※ The Compression and Resolution settings areas are grayed out and disabled.



### Caution

- New settings are saved only if you click the **Apply** button at the bottom of the screen. The **Cancel** button cancels new settings.

## 4.2.4.3. Time

The screenshot shows the 'Time' configuration page in the iPOLiS Network Security Solution interface. The page is divided into three main sections:

- Current Time:** Displays the current date and time as '2009-04-05 23:57:19 (+00:00)'.
- Time Zone:** Includes a dropdown menu for selecting a GMT city (currently '(GMT) Greenwich Mean Time: Dublin, Edinburgh, Lisbon, London'), a checkbox for 'Use Daylight Saving Time', and fields for 'Start' and 'End' dates.
- Time Setup:** Contains two sub-sections:
  - Set Manually:** Features input fields for 'Date' (format: yyyy/mm/dd) and 'Time' (format: hh:mm).
  - TimeServer:** Lists five server addresses:
    - Server 1: pool.ntp.org
    - Server 2: asia.pool.ntp.org
    - Server 3: europe.pool.ntp.org
    - Server 4: north-america.pool.ntp.org
    - Server 5: time.nist.gov

Buttons for 'Apply' and 'Cancel' are located at the bottom of the Time Setup section.

### ■ Current Time

Displays the current time.

### ■ Time Zone

Select the GMT and city of the camera.

Check Use Daylight Saving Time to apply DST according to your city and country.

### ■ Time Setup

Category	Description
Date	Configures the current date of the camera.
Time	Configures the current time of the camera.

### ■ Time Server

Enter the address of your NTP (Network Time Protocol) server. NTP (Network Time Protocol) synchronizes the time among the various devices and systems connected to a network; the NTP client automatically communicates with other servers to adjust its time setting. If you want to use an NTP server other than the default, change the address of Server1 to Server5.



### Caution

- To change time by using the Set Manually option, you must fill out all fields.

## Chapter 4. Using Web Viewer

### 4.2.4.4. Log Message

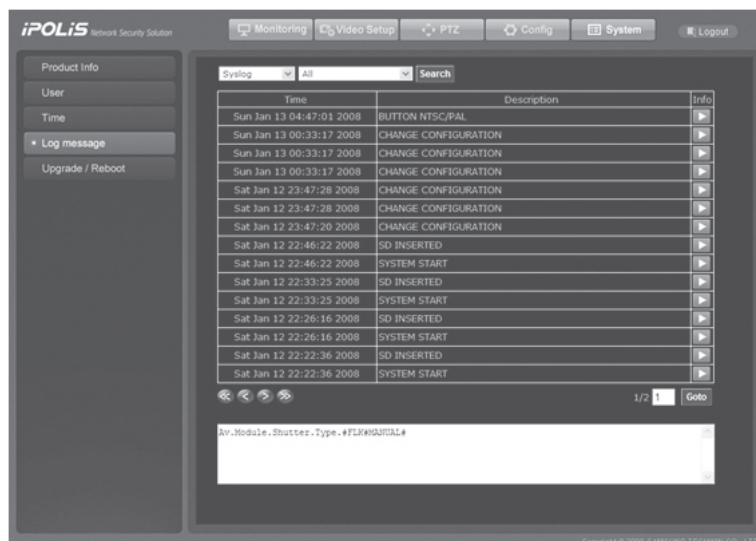

Category	Description
Syslog (System Log)	Displays system logs in 5 different categories: Device, Network, User, Configuration, and Etc. Select a category and then press Search to display logs. Selecting All displays all available information regarding System Log.
Evtlog (Event Log)	Displays event logs in 5 different categories: Motion Detection, Sensor Input, Relay Output, and Etc. Select a category and then press Search to display logs. Selecting All displays all available information regarding Event Log.
Time	Displays the time when the event is logged.
Description	Displays the description of a log.
Info	Displays the details of a log on a window at the bottom.
⏪	Moves to the first page.
⏩	Moves to the previous page.
⏪	Moves to the next page.
⏩	Moves to the last page.
Goto	Enter a page number, and then press the Goto button to move to the page directly.

## 4.2.4.5. Upgrade

Updates the program of the SNP-3370/3301 network camera.

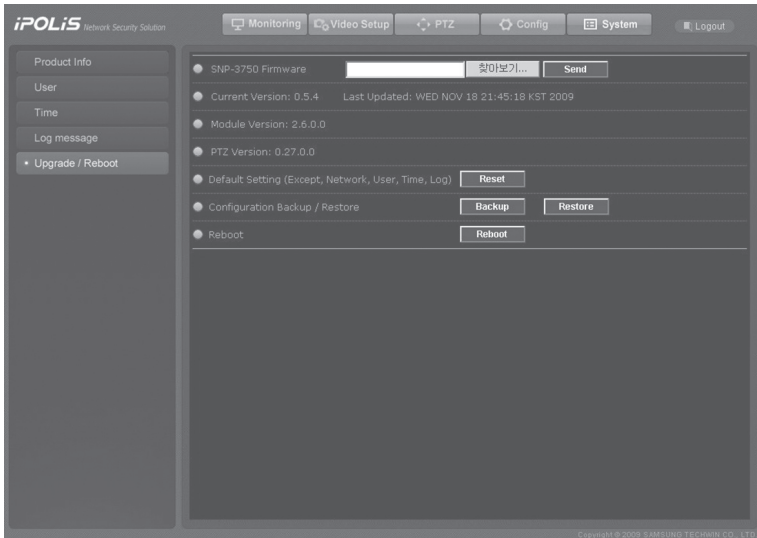

### ■ System Upgrade Configuration

Category	Description				
SNP-3370/3301 Firmware	Upgrades the firmware of the network camera.				
Current Version Last Updated	Displays the current firmware version of the camera along with the latest updated date and time.				
Module Version	Indicates the version of the camera module.				
PTZ Version	Indicates the version of the Motion module.				
Default Setting	<p>When pressing the Reset button, existing data apart from the settings below are reset completely.</p> <table border="1"> <thead> <tr> <th>Exceptions</th> </tr> </thead> <tbody> <tr> <td>Settings on the Config → Network page</td> </tr> <tr> <td>Settings on the System → Log page</td> </tr> <tr> <td>Settings on the System → Time page</td> </tr> </tbody> </table>	Exceptions	Settings on the Config → Network page	Settings on the System → Log page	Settings on the System → Time page
Exceptions					
Settings on the Config → Network page					
Settings on the System → Log page					
Settings on the System → Time page					
Configuration Backup	Saves the current camera settings as a file.				
Configuration Restore	Restores the previous camera settings using a backup file.				
Reboot	Reboots the camera.				

## Chapter 5. Troubleshooting

If you are having problems with the product, please consult the following information first. If the problem persists, contact your vendor.

Problem	Cause and Solution
The controller does not control the camera.	<ul style="list-style-type: none"> <li>▶ Make sure the camera is connected to a network.</li> <li>▶ Verify the settings for ID, protocol, and baud rates. (Refer to Chapter 3. Installing Camera &amp; Network Setup)</li> </ul>
No video is displayed on the monitor.	<ul style="list-style-type: none"> <li>▶ Check if the power cable is securely connected to the camera and the monitor. Check if the video cable is properly connected. Consult the operation manual for the system controller connected to the camera.</li> <li>▶ Check the camera's fixed shutter speed. Adjust the camera's shutter menu.</li> </ul>
The picture is too dark/bright.	<ul style="list-style-type: none"> <li>▶ Check the camera's Brightness menu. Adjust the camera's Brightness menu.</li> </ul>
The monitor displays nothing but a white image.	<ul style="list-style-type: none"> <li>▶ Check the WDR settings.</li> </ul>
The monitoring screen is out of focus.	<ul style="list-style-type: none"> <li>▶ Check if the dome cover or the camera lens is dirty or smudged. If it is, clean the dirt off.</li> <li>▶ Verify the distance between the camera and the subject, as well as the subject's surroundings. The camera may have difficulty focusing on a subject against a white background.</li> <li>▶ If the camera is having difficulty auto-focusing on a particular subject, set the Focus mode to Manual and adjust the focus manually.</li> <li>▶ Use the camera reset menu to restore the camera settings to default.</li> </ul>
The monitoring screen is out of focus.	<ul style="list-style-type: none"> <li>▶ Adjust the Sharpness level.</li> </ul>
Digital noise appears on the screen.	<ul style="list-style-type: none"> <li>▶ Check if the video cable is properly connected.</li> <li>▶ Make sure that the power cable and video cable do not exceed the recommended maximum lengths.</li> <li>▶ Adjust the Sharpness level.</li> </ul>
The monitoring screen is flickering.	<ul style="list-style-type: none"> <li>▶ Check if the camera is pointing directly at a fluorescent light or sunlight. If so, change the camera's direction to remove the flickering.</li> </ul>

Afterimages appear on the screen.	▶ Check the Sens-Up settings.
The camera switches between color and B&W modes too frequently.	▶ Adjust Duration and Dwell Time in the Day & Night menu.
Pan, tilt, zoom, and/or focus do not work.	▶ Check if the power cable is securely connected to the camera and the monitor. Check if the video cable is properly connected. Consult the operation manual for the system controller connected to the camera.
	▶ Check if Pan Limit and/or Tilt Limit are configured. If so, remove the limit(s).
	▶ A motor or the lens may be overheating. If so, contact your service personnel or system provider for assistance.
The camera's position differs from the position defined in a preset.	▶ This phenomenon may happen, since the motors have a margin of error of $\pm 0.1^\circ$ .
The Sequence configuration for the camera does not work.	▶ Check if Preset or another operation mode are configured.
	▶ Check the Auto Refresh settings.
The upper portion of the picture is dark when the camera is at a horizontal reference point.	▶ You are seeing the camera's internal cover; the camera is functioning normally.
The camera suddenly turns on or moves to a preset position by itself.	▶ Check the Auto Run settings. This function commands the camera to automatically perform a preset sequence action if no command has been entered via the controller for a while.
	▶ Check the Auto Refresh settings. This function optimizes the camera's circuitry and components according to a predefined schedule.
Cannot see a video image sent to the FTP server or via e-mail.	▶ If your computer is not installed with the Divx codec for decoding H.264, MPEG-4 compressed images, the image may not display properly. Download and install the latest DivX file, and then check the image again. <a href="http://www.divx.com/divx/download">http://www.divx.com/divx/download</a>

## Chapter 5. Troubleshooting

<p>Saved contents is not displayed in the SD memory card.</p>	<ul style="list-style-type: none"> <li>▶ Make sure that you do not remove the memory card while contents are being saved.</li> <li>▶ Check if the SD memory card is properly inserted.</li> <li>▶ Check if the capacity on the card is correct on the Record page.</li> </ul>
<p>Product information is not displayed on the local network.</p>	<ul style="list-style-type: none"> <li>▶ Check if the network cables are properly connected.</li> <li>▶ Reset the camera to the factory defaults by pressing the RESET switch on the back of the camera for 5 seconds, and then check again.</li> </ul>
<p>Sudden video pause</p>	<ul style="list-style-type: none"> <li>▶ Check if the SNP-3370/3301 network camera is connected properly using a network cable.</li> <li>▶ When using an extra network device such as a hub or IP router, check if the device is in operation.</li> <li>▶ Open a command prompt and check if the SNP-3370/3301 network camera is connected to the network.</li> </ul>
<p><b>Regular Power Cord Check</b></p>	
<ul style="list-style-type: none"> <li>• The power cord's coating has been damaged.</li> <li>• The power cord is hot to touch when the product is in operation.</li> <li>• The power cord gets hot it has been bent or pulled.</li> </ul>	<p>Continuing to use the product when its power cord is damaged constitutes an electrical and fire hazard. The power plug must be removed from the outlet immediately, and qualified service personnel or your system provider should be contacted for assistance.</p>

## PC Requirements

Category	Minimun Requirements	Recommended Requirements
CPU	Intel Core 2 Duo E4300 or better	Intel Core 2 Duo E7400 or better
Main Memory	1GB or more	2GB or more
Video Memory	256MB or more	512MB or more
Display	1024 x 768 (with 32bit color) or higher / OpenGL compatible	
Hard Disk	80GB or more	
Operating System	Windows XP Professional / Windows Vista	
Network	10/100 Base-T Ethernet	
Internet Explore	6.0 or better	
etc	DirectX 9.0 or higher	

## Specifications

Model Name	SNP-3370	SNP-3301
<b>Camera</b>		
Imaging Device	1/4 inch, Color Vertical Double Density Interline Transfer CCD	
TV Standard	NTSC / PAL	
Total Pixels	NTSC:811(H) x 508(V) / PAL:795(H) x 596(V)	
Effective Pixels	NTSC:768(H) x 494(V) / PAL:752(H) x 582(V)	
Synchronization	Internal	
Imaging Frequency	H:15.734 KHz / V:59.94 Hz	
Horizontal Scan Rate	NTSC:15.734 KHz / PAL:15.625 KHz	
Vertical Scan Rate	NTSC:59.94 Hz / PAL: 50 Hz	
Horizontal Resolution	Color: 550TVL (Min.) , B/W: 680TVL (Min.)	
Minimum Luminance	0.7 Lux @ F1.6 ( Color ) 0.0001Lux @ F1.6 (Sens-up 256X)	
S/N Ratio (AGC Off)	50 dB	50 dB
OSD	Embedded	
Camera ID	1~255	
Day & Night	AUTO / COLOR / BW	
Backlight	WDR / BLC / HLC / OFF	
Dynamic Range	52dB	
DIS (Digital Image Stabilization)	ON / OFF	
Privacy Protection	ON / OFF(8 Areas)	
SSNR	LOW / MIDDLE / HIGH / OFF	
Sens-up	AUTO / Off (Selectable limit ~ 256X )	
Gain Control	LOW / MEDIUM / HIGH / OFF	
White Balance	ATW / AWC / MANUAL /INDOOR / OUTDOOR	
Electronic Shutter	AUTO(NTSC:1/60~120,000sec, PAL:1/50~120,000sec)/MANUAL/A.FLK	
<b>Lens</b>		
Zoom Ratio	37X (Optical) , 12X (Digital)	30x(Optical) ,12X(Digital)
Focal Length	3.5 ~ 129.5mm (F1.6 to 3.9)	3.5~105mm (F1.6 to 3.3)
Max. Aperture Ratio	1:1.6(Wide) ~ 3.9(Tele)	1:1.6(Wide) ~ 3.6(Tele)
Min. Object Distance	1.8m	
Angle of View	Horizontal	55.5°(Wide) ~ 1.59°(Tele)
	Vertical	42.5°(Wide) ~ 1.19°(Tele)
Focus	Horizontal	55.5°(Wide) ~ 1.77°(Tele)
	Vertical	42.5°(Wide) ~ 1.33°(Tele)
Focus	AUTO / MANUAL / ONE-SHOT	
Zoom Movement Speed	2.5 sec	2.2 sec
IRIS Control	AUTO/MANUAL	
Lens Initialization	Built-In	
<b>Pan / Tilt</b>		
Pan Angle	360°	
Pan Speed	Preset	500°/sec
	Manual	0.024°~120°/sec (Proportional Zoom Ratio)
Tilt Angle	-5° ~ 185°	

# Specifications

Tilt Speed	Preset	500°/sec
	Manual	0.024°~120°/sec (Proportional Zoom Ratio)
Preset		255
Preset Accuracy		±0.1°
PTZ Mode		Preset, Swing, Group, Tour, Trace, Auto Run
<b>Performance</b>		
Encoding	Resolution	4CIF, CIF, QCIF
	Compression Method	H.264/MPEG-4/JPEG Dual Codec
	Compression Rate	Up to 30fps @ 4CIF
	Image Quality	5 levels Very High, High, Middle, Low, Very Low
Network	Data Transfer Speed	Up to 100Mbps
	Concurrent Users	Max. 10
	Protocol	RTP/UDP, RTP/Multicast, RTSP, TCP/IP, DHCP, DNS, DDNS, HTTP, SMTP, FTP, PPPoE, NTP, STW, Pelco-D, Pelco-P, Panasonic, Honeywell, AD, Vicon, SEC
	Area Zoom	Web viewer, SVM - S1(CMS)
Security	Password Authorization	5 User Levels
Intelligence Feature		Motion Detection / Appear-Disappear
<b>Interface</b>		
Monitor	Output	1 Video Out (BNC, for Installation)
Audio	Input	1 Phone Jack, Line in (1Vpp) / MIC in (2K ohm)
	Output	1 Phone Jack, Line out (1Vpp) / Speaker out (16 ohm)
	Compression Method	ADPCM
	Sampling Rate	8 KHz
Alarm	Input	Terminal 4 Input, NO/NC
	Output	Terminal 2 Output, NO/NC
	Remote Alert	E-Mail, FTP Notice
Connection	Ethernet Port	RJ-45 10/100 Base-T
Storage	SD (SDHC) Memory	Event Image Storage & Backup: 1G~2G SD Card, 4G SDHC Card
<b>General</b>		
Input Voltage		24V AC ±10%
Power Consumption		Max. 16W
Operating Temperature		-10° ~ +50° / 20% ~ 80% RH
Dimensions (W×H)		Ø155×243.4mm
Weight		2.1Kg
IP		IP67 ( Optional Housing )

## Dimension

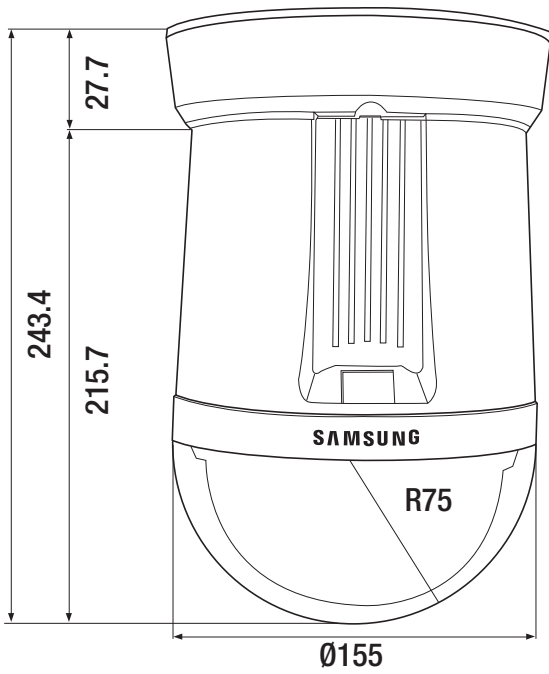
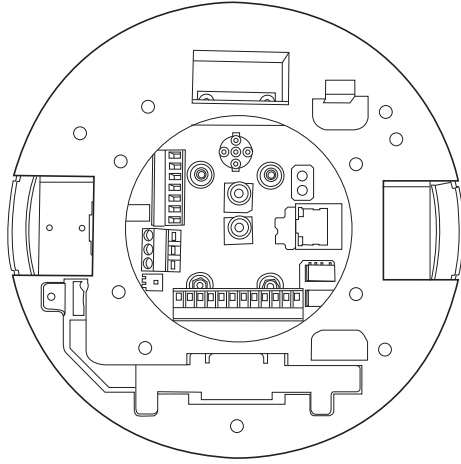

## GPL/LGPL SOFTWARE LICENSE

The software included in this product contains copyrighted software that is licensed under the GPL/LGPL. You may obtain the complete Corresponding Source code from us for a period of three years after our last shipment of this product by sending email to [help.cctv@samsung.com](mailto:help.cctv@samsung.com)

If you want to obtain the complete Corresponding Source code in the physical medium such as CD-ROM, the cost of physically performing source distribution might be charged.

- **GPL S/W**
  - Base Kernel, Busybox, Sysvinit, dosfstools
- **LGPL S/W**
  - glibc, lnutils

## GNU GENERAL PUBLIC LICENSE

Version 2, June 1991

Copyright (C) 1989, 1991 Free Software Foundation, Inc.

51 Franklin Street, Fifth Floor, Boston, MA 02110-1301, USA

Everyone is permitted to copy and distribute verbatim copies of this license document, but changing it is not allowed.

### Preamble

The licenses for most software are designed to take away your freedom to share and change it. By contrast, the GNU General Public License is intended to guarantee your freedom to share and change free software to make sure the software is free for all its users. This General Public License applies to most of the Free Software Foundation's software and to any other program whose authors commit to using it. (Some other Free Software Foundation software is covered by the GNU Lesser General Public License instead.) You can apply it to your programs, too.

When we speak of free software, we are referring to freedom, not price. Our General Public Licenses are designed to make sure that you have the freedom to distribute copies of free software (and charge for this service if you wish), that you receive source code or can get it if you want it, that you can change the software or use pieces of it in new free programs; and that you know you can do these things.

To protect your rights, we need to make restrictions that forbid anyone to deny you these rights or to ask you to surrender the rights. These restrictions translate to certain responsibilities for you if you distribute copies of the software, or if you modify it.

For example, if you distribute copies of such a program, whether gratis or for a fee, you must give the recipients all the rights that you have. You must make sure that they, too, receive or can get the source code. And you must show them these terms so they know their rights.

We protect your rights with two steps:

- (1) copyright the software, and (2) offer you this license which gives you legal permission to copy, distribute and/or modify the software.

Also, for each author's protection and ours, we want to make certain that everyone understands that there is no warranty for this free software. If the software is modified by someone else and passed

on, we want its recipients to know that what they have is not the original, so that any problems introduced by others will not reflect on the original authors' reputations. Finally, any free program is threatened constantly by software patents. We wish to avoid the danger that redistributors of a free program will individually obtain patent licenses, in effect making the program proprietary. To prevent this, we have made it clear that any patent must be licensed for everyone's free use or not licensed at all. The precise terms and conditions for copying, distribution and modification follow.

## **TERMS AND CONDITIONS FOR COPYING, DISTRIBUTION AND MODIFICATION**

Version 2, June 1991 Copyright (C) 1989, 1991 Free Software Foundation, Inc. 51 Franklin S

0. This License applies to any program or other work which contains a notice placed by the copyright holder saying it may be distributed under the terms of this General Public License. The "Program", below, refers to any such program or work, and a "work based on the Program" means either the Program or any derivative work under copyright law: that is to say, a work containing the Program or a portion of it, either verbatim or with modifications and/or translated into another language. (Hereinafter, translation is included without limitation in the term "modification".) Each licensee is addressed as "you". Activities other than copying, distribution and modification are not covered by this License; they are outside its scope. The act of running the Program is not restricted, and the output from the Program is covered only if its contents constitute a work based on the Program (independent of having been made by running the Program). Whether that is true depends on what the Program does.

1. You may copy and distribute verbatim copies of the Program's source code as you receive it, in any medium, provided that you conspicuously and appropriately publish on each copy an appropriate copyright notice and disclaimer of warranty; keep intact all the notices that refer to this License and to the absence of any warranty; and give any other recipients of the Program a copy of this License along with the Program.

You may charge a fee for the physical act of transferring a copy, and you may at your option offer warranty protection in exchange for a fee.

2. You may modify your copy or copies of the Program or any portion of it, thus forming a work based on the Program, and copy and distribute such modifications or work under the terms of Section 1 above, provided that you also meet all of these conditions:

- a) You must cause the modified files to carry prominent notices stating that you changed the files and the date of any change.
- b) You must cause any work that you distribute or publish, that in whole or in part contains or is derived from the Program or any part thereof, to be licensed as a whole at no charge to all third parties under the terms of this License.
- c) If the modified program normally reads commands interactively when run, you must cause it, when started running for such interactive use in the most ordinary way, to print or display an announcement including an appropriate copyright notice and a notice that there is no warranty (or else, saying that you provide a warranty) and that users may redistribute the program under these conditions, and telling the user how to view a copy of this License. (Exception: if the Program itself is interactive but does not normally print such an announcement, your work based on the Program is not required to print an announcement.)

These requirements apply to the modified work as a whole. If identifiable sections of that work are not derived from the Program, and can be reasonably considered independent and separate works in themselves, then this License, and its terms, do not apply to those sections when you distribute them as separate works. But when you distribute the same sections as part of a whole which is a work based on the Program, the distribution of the whole must be on the terms of this License, whose permissions for other licensees extend to the entire whole, and thus to each and every part regardless of who wrote it.

Thus, it is not the intent of this section to claim rights or contest your rights to work written entirely by you; rather, the intent is to exercise the right to control the distribution of derivative or collective works based on the Program.

In addition, mere aggregation of another work not based on the Program with the Program (or with a work based on the Program) on a volume of a storage or distribution medium does not bring the other work under the scope of this License.

3. You may copy and distribute the Program (or a work based on it, under Section 2) in object code or executable form under the terms of Sections 1 and 2 above provided that you also do one of the following:
  - a) Accompany it with the complete corresponding machine-readable source code, which must be distributed under the terms of Sections 1 and 2 above on a medium customarily used for software interchange; or,
  - b) Accompany it with a written offer, valid for at least three years, to give any third party, for a charge no more than your cost of physically performing source distribution, a complete machine-readable copy of the corresponding source code, to be distributed under the terms of Sections 1 and 2 above on a medium customarily used for software interchange; or,
  - c) Accompany it with the information you received as to the offer to distribute corresponding source code. (This alternative is allowed only for noncommercial distribution and only if you received the program in object code or executable form with such an offer, in accord with Subsection b above.)

The source code for a work means the preferred form of the work for making modifications to it. For an executable work, complete source code means all the source code for all modules it contains, plus any associated interface definition files, plus the scripts used to control compilation and installation of the executable. However, as a special exception, the source code distributed need not include anything that is normally distributed (in either source or binary form) with the major components (compiler, kernel, and so on) of the operating system on which the executable runs, unless that component itself accompanies the executable.

If distribution of executable or object code is made by offering access to copy from a designated place, then offering equivalent access to copy the source code from the same place counts as distribution of the source code, even though third parties are not compelled to copy the source along with the object code.

4. You may not copy, modify, sublicense, or distribute the Program except as expressly provided under this License. Any attempt otherwise to copy, modify, sublicense or distribute the Program is void, and will automatically terminate your rights under this License. However, parties who have received copies, or rights, from you under this License will not have their licenses terminated so long as such parties remain in full compliance.

5. You are not required to accept this License, since you have not signed it. However, nothing else grants you permission to modify or distribute the Program or its derivative works. These actions are prohibited by law if you do not accept this License. Therefore, by modifying or distributing the Program (or any work based on the Program), you indicate your acceptance of this License to do so, and all its terms and conditions for copying, distributing or modifying the Program or works based on it.
6. Each time you redistribute the Program (or any work based on the Program), the recipient automatically receives a license from the original licensor to copy, distribute or modify the Program subject to these terms and conditions. You may not impose any further restrictions on the recipients' exercise of the rights granted herein. You are not responsible for enforcing compliance by third parties to this License.
7. If, as a consequence of a court judgment or allegation of patent infringement or for any other reason (not limited to patent issues), conditions are imposed on you (whether by court order, agreement or otherwise) that contradict the conditions of this License, they do not excuse you from the conditions of this License. If you cannot distribute so as to satisfy simultaneously your obligations under this License and any other pertinent obligations, then as a consequence you may not distribute the Program at all. For example, if a patent license would not permit royalty-free redistribution of the Program by all those who receive copies directly or indirectly through you, then the only way you could satisfy both it and this License would be to refrain entirely from distribution of the Program.  
If any portion of this section is held invalid or unenforceable under any particular circumstance, the balance of the section is intended to apply and the section as a whole is intended to apply in other circumstances.  
It is not the purpose of this section to induce you to infringe any patents or other property right claims or to contest validity of any such claims; this section has the sole purpose of protecting the integrity of the free software distribution system, which is implemented by public license practices. Many people have made generous contributions to the wide range of software distributed through that system in reliance on consistent application of that system; it is up to the author/donor to decide if he or she is willing to distribute software through any other system and a licensee cannot impose that choice. This section is intended to make thoroughly clear what is believed to be a consequence of the rest of this License.
8. If the distribution and/or use of the Program is restricted in certain countries either by patents or by copyrighted interfaces, the original copyright holder who places the Program under this License may add an explicit geographical distribution limitation excluding those countries, so that distribution is permitted only in or among countries not thus excluded. In such case, this License incorporates the limitation as if written in the body of this License.
9. The Free Software Foundation may publish revised and/or new versions of the General Public License from time to time. Such new versions will be similar in spirit to the present version, but may differ in detail to address new problems or concerns.

Each version is given a distinguishing version number. If the Program specifies a version number of this License which applies to it and "any later version", you have the option of following the terms and conditions either of that version or of any later version published by the Free Software Foundation. If the

Program does not specify a version number of this License, you may choose any version ever published by the Free Software Foundation.

10. If you wish to incorporate parts of the Program into other free programs whose distribution conditions are different, write to the author to ask for permission. For software which is copyrighted by the Free Software Foundation, write to the Free Software Foundation; we sometimes make exceptions for this. Our decision will be guided by the two goals of preserving the free status of all derivatives of our free software and of promoting the sharing and reuse of software generally.

## **NO WARRANTY**

11. BECAUSE THE PROGRAM IS LICENSED FREE OF CHARGE, THERE IS NO WARRANTY FOR THE PROGRAM, TO THE EXTENT PERMITTED BY APPLICABLE LAW. EXCEPT WHEN OTHERWISE STATED IN WRITING THE COPYRIGHT HOLDERS AND/OR OTHER PARTIES PROVIDE THE PROGRAM "AS IS" WITHOUT WARRANTY OF ANY KIND, EITHER EXPRESSED OR IMPLIED, INCLUDING, BUT NOT LIMITED TO, THE IMPLIED WARRANTIES OF MERCHANTABILITY AND FITNESS FOR A PARTICULAR PURPOSE. THE ENTIRE RISK AS TO THE QUALITY AND PERFORMANCE OF THE PROGRAM IS WITH YOU. SHOULD THE PROGRAM PROVE DEFECTIVE, YOU ASSUME THE COST OF ALL NECESSARY SERVICING, REPAIR OR CORRECTION.
12. IN NO EVENT UNLESS REQUIRED BY APPLICABLE LAW OR AGREED TO IN WRITING WILL ANY COPYRIGHT HOLDER, OR ANY OTHER PARTY WHO MAY MODIFY AND/OR REDISTRIBUTE THE PROGRAM AS PERMITTED ABOVE, BE LIABLE TO YOU FOR DAMAGES, INCLUDING ANY GENERAL, SPECIAL, INCIDENTAL OR CONSEQUENTIAL DAMAGES ARISING OUT OF THE USE OR INABILITY TO USE THE PROGRAM (INCLUDING BUT NOT LIMITED TO LOSS OF DATA OR DATA BEING RENDERED INACCURATE OR LOSSES SUSTAINED BY YOU OR THIRD PARTIES OR A FAILURE OF THE PROGRAM TO OPERATE WITH ANY OTHER PROGRAMS), EVEN IF SUCH HOLDER OR OTHER PARTY HAS BEEN ADVISED OF THE POSSIBILITY OF SUCH DAMAGES.

## **END OF TERMS AND CONDITIONS**

### **How to Apply These Terms to Your New Programs**

If you develop a new program, and you want it to be of the greatest possible use to the public, the best way to achieve this is to make it free software which everyone can redistribute and change under these terms.

To do so, attach the following notices to the program. It is safest to attach them to the start of each source file to most effectively convey the exclusion of warranty; and each file should have at least the "copyright" line and a pointer to where the full notice is found.

one line to give the program's name and an idea of what it does. Copyright (C) yyyy name of author  
This program is free software; you can redistribute it and/or modify it under the terms of the GNU General Public License as published by the Free Software Foundation; either version 2 of the License, or (at your option) any later version.

This program is distributed in the hope that it will be useful, but WITHOUT ANY WARRANTY; without even the implied warranty of MERCHANTABILITY or FITNESS FOR A PARTICULAR PURPOSE. See the GNU General Public License for more details.

You should have received a copy of the GNU General Public License along with this program; if not, write to the Free Software Foundation, Inc., 51 Franklin Street, Fifth Floor, Boston, MA 02110-1301, USA.

Also add information on how to contact you by

electronic and paper mail. If the program is interactive, make it output a short notice like this when it starts in an interactive mode:

Gnomovision version 69, Copyright (C) year name of author Gnomovision comes with ABSOLUTELY NO WARRANTY; for details type 'show w'. This is free software, and you are welcome to redistribute it under certain conditions; type 'show c' for details.

The hypothetical commands 'show w' and 'show c' should show the appropriate parts of the General Public License. Of course, the commands you use may be called something other than 'show w' and 'show c'; they could even be mouse-clicks or menu items—whatever suits your program.

You should also get your employer (if you work as a programmer) or your school, if any, to sign a “copyright disclaimer” for the program, if necessary. Here is a sample; alter the names:

Yoyodyne, Inc., hereby disclaims all copyright interest in the program 'Gnomovision' (which makes passes at compilers) written by James Hacker.

signature of Ty Coon, 1 April 1989 Ty Coon, President of Vice This General Public License does not permit

incorporating your program into proprietary programs. If your program is a subroutine library, you may consider it more useful to permit linking proprietary applications with the library. If this is what you want to do, use the GNU Lesser General Public License instead of this License.

## GNU GENERAL PUBLIC LICENSE

Version 3, 29 June 2007

Copyright © 2007 Free Software Foundation, Inc. <<http://fsf.org/>> Everyone is permitted to copy and distribute verbatim

copies of this license document, but changing it is not allowed.

### Preamble

The GNU General Public License is a free, copyleft

license for software and other kinds of works. The licenses for most software and other practical works are designed to take away your freedom to share and change the works. By contrast, the GNU General Public License is intended to guarantee your freedom to share and change all versions of a program--to make sure it remains free software for all its users. We, the Free Software Foundation, use the GNU General Public License for most of our software; it applies also to any other work released this way by its authors. You can apply it to your programs, too.

When we speak of free software, we are referring to freedom, not price. Our General Public Licenses are designed to make sure that you have the freedom to distribute copies of free software (and charge for them if you wish), that you receive source code or can get it if you want it, that you can change the software or use pieces of it in new free programs, and that you know you can do these things.

To protect your rights, we need to prevent others from denying you these rights or asking you to

surrender the rights. Therefore, you have certain responsibilities if you distribute copies of the software, or if you modify it: responsibilities to respect the freedom of others.

For example, if you distribute copies of such a program, whether gratis or for a fee, you must pass on to the recipients the same freedoms that you received. You must make sure that they, too, receive or can get the source code. And you must show them these terms so they know their rights.

Developers that use the GNU GPL protect your rights with two steps: (1) assert copyright on the software, and (2) offer you this License giving you legal permission to copy, distribute and/or modify it.

For the developers' and authors' protection, the GPL clearly explains that there is no warranty for this free software. For both users' and authors' sake, the GPL requires that modified versions be marked as changed, so that their problems will not be attributed erroneously to authors of previous versions.

Some devices are designed to deny users access to install or run modified versions of the software inside them, although the manufacturer can do so. This is fundamentally incompatible with the aim of protecting users' freedom to change the software. The systematic pattern of such abuse occurs in the area of products for individuals to use, which is precisely where it is most unacceptable. Therefore, we have designed this version of the GPL to prohibit the practice for those products. If such problems arise substantially in other domains, we stand ready to extend this provision to those domains in future versions of the GPL, as needed to protect the freedom of users.

Finally, every program is threatened constantly by software patents. States should not allow patents to restrict development and use of software on general-purpose computers, but in those that do, we wish to avoid the special danger that patents applied to a free program could make it effectively proprietary. To prevent this, the GPL assures that patents cannot be used to render the program non-free.

The precise terms and conditions for copying, distribution and modification follow.

## TERMS AND CONDITIONS

### 0. Definitions.

“This License” refers to version 3 of the GNU General Public License.

“Copyright” also means copyright-like laws that apply to other kinds of works, such as semiconductor masks.

“The Program” refers to any copyrightable work licensed under this License. Each licensee is addressed as “you”. “Licensees” and “recipients” may be individuals or organizations.

To “modify” a work means to copy from or adapt all or part of the work in a fashion requiring copyright permission, other than the making of an exact copy. The resulting work is called a “modified version” of the earlier work or a work “based on” the earlier work.

A “covered work” means either the unmodified Program or a work based on the Program.

To “propagate” a work means to do anything with it that, without permission, would make you directly or secondarily liable for infringement under applicable copyright law, except executing it on a computer or modifying a private copy. Propagation includes copying, distribution (with or without modification), making available to the public, and in some countries other activities as well.

To “convey” a work means any kind of propagation that enables other parties to make or receive copies.

Mere interaction with a user through a computer network, with no transfer of a copy, is not conveying.

An interactive user interface displays “Appropriate Legal Notices” to the extent that it includes a

convenient and prominently visible feature that (1) displays an appropriate copyright notice, and (2) tells the user that there is no warranty for the work (except to the extent that warranties are provided), that licensees may convey the work under this License, and how to view a copy of this License. If the interface presents a list of user commands or options, such as a menu, a prominent item in the list meets this criterion.

### **1. Source Code.**

The “source code” for a work means the preferred form of the work for making modifications to it.

“Object code” means any non-source form of a work.

A “Standard Interface” means an interface that either is an official standard defined by a recognized standards body, or, in the case of interfaces specified for a particular programming language, one that is widely used among developers working in that language.

The “System Libraries” of an executable work include anything, other than the work as a whole, that (a) is included in the normal form of packaging a Major Component, but which is not part of that Major Component, and (b) serves only to enable use of the work with that Major Component, or to implement a Standard Interface for which an implementation is available to the public in source code form. A “Major Component”, in this context, means a major essential component (kernel, window system, and so on) of the specific operating system (if any) on which the executable work runs, or a compiler used to produce the work, or an object code interpreter used to run it.

The “Corresponding Source” for a work in object code form means all the source code needed to generate, install, and (for an executable work) run the object code and to modify the work, including scripts to control those activities. However, it does not include the work’s System Libraries, or general-purpose tools or generally available free programs which are used unmodified in performing those activities but which are not part of the work. For example, Corresponding Source includes interface definition files associated with source files for the work, and the source code for shared libraries and dynamically linked subprograms that the work is specifically designed to require, such as by intimate data communication or control flow between those subprograms and other parts of the work.

The Corresponding Source need not include anything that users can regenerate automatically from other parts of the Corresponding Source.

The Corresponding Source for a work in source code form is that same work.

### **2. Basic Permissions.**

All rights granted under this License are granted for the term of copyright on the Program, and are irrevocable provided the stated conditions are met. This License explicitly affirms your unlimited permission to run the unmodified Program. The output from running a covered work is covered by this License only if the output, given its content, constitutes a covered work. This License acknowledges your rights of fair use or other equivalent, as provided by copyright law.

You may make, run and propagate covered works that you do not convey, without conditions so long as your license otherwise remains in force. You may convey covered works to others for the sole purpose of having them make modifications exclusively for you, or provide you with facilities for running those works, provided that you comply with the terms of this License in conveying all material for which you do not control copyright. Those thus making or running the covered works for you must do so exclusively on

your behalf, under your direction and control, on terms that prohibit them from making any copies of your copyrighted material outside their relationship with you.  
Conveying under any other circumstances is permitted solely under the conditions stated below.  
Sublicensing is not allowed; section 10 makes it unnecessary.

### **3. Protecting Users' Legal Rights From Anti-Circumvention Law.**

No covered work shall be deemed part of an effective technological measure under any applicable law fulfilling obligations under article 11 of the WIPO copyright treaty adopted on 20 December 1996, or similar laws prohibiting or restricting circumvention of such measures.

When you convey a covered work, you waive any legal power to forbid circumvention of technological measures to the extent such circumvention is effected by exercising rights under this License with respect to the covered work, and you disclaim any intention to limit operation or modification of the work as a means of enforcing, against the work's users, your or third parties' legal rights to forbid circumvention of technological measures.

### **4. Conveying Verbatim Copies.**

You may convey verbatim copies of the Program's source code as you receive it, in any medium, provided that you conspicuously and appropriately publish on each copy an appropriate copyright notice; keep intact all notices stating that this License and any non-permissive terms added in accord with section 7 apply to the code; keep intact all notices of the absence of any warranty; and give all recipients a copy of this License along with the Program.

You may charge any price or no price for each copy that you convey, and you may offer support or warranty protection for a fee.

### **5. Conveying Modified Source Versions.**

You may convey a work based on the Program, or the modifications to produce it from the Program, in the form of source code under the terms of section 4, provided that you also meet all of these conditions:

- a) The work must carry prominent notices stating that you modified it, and giving a relevant date.
- b) The work must carry prominent notices stating that it is released under this License and any conditions added under section 7. This requirement modifies the requirement in section 4 to "keep intact all notices".
- c) You must license the entire work, as a whole, under this License to anyone who comes into possession of a copy. This License will therefore apply, along with any applicable section 7 additional terms, to the whole of the work, and all its parts, regardless of how they are packaged. This License gives no permission to license the work in any other way, but it does not invalidate such permission if you have separately received it.
- d) If the work has interactive user interfaces, each must display Appropriate Legal Notices; however, if the Program has interactive interfaces that do not display Appropriate Legal Notices, your work need not make them do so.

A compilation of a covered work with other separate and independent works, which are not by their nature extensions of the covered work, and which are not combined with it such as to form a larger program, in or on a volume of a storage or distribution medium, is called an "aggregate" if the

compilation and its resulting copyright are not used to limit the access or legal rights of the compilation's users beyond what the individual works permit. Inclusion of a covered work in an aggregate does not cause this License to apply to the other parts of the aggregate.

## 6. Conveying Non-Source Forms.

You may convey a covered work in object code form under the terms of sections 4 and 5, provided that you also convey the machine-readable Corresponding Source under the terms of this License, in one of these ways:

- a) Convey the object code in, or embodied in, a physical product (including a physical distribution medium), accompanied by the Corresponding Source fixed on a durable physical medium customarily used for software interchange.
- b) Convey the object code in, or embodied in, a physical product (including a physical distribution medium), accompanied by a written offer, valid for at least three years and valid for as long as you offer spare parts or customer support for that product model, to give anyone who possesses the object code either (1) a copy of the Corresponding Source for all the software in the product that is covered by this License, on a durable physical medium customarily used for software interchange, for a price no more than your reasonable cost of physically performing this conveying of source, or (2) access to copy the Corresponding Source from a network server at no charge.
- c) Convey individual copies of the object code with a copy of the written offer to provide the corresponding Source. This alternative is allowed only occasionally and noncommercially, and only if you received the object code with such an offer, in accord with subsection 6b.
- d) Convey the object code by offering access from a designated place (gratis or for a charge), and offer equivalent access to the Corresponding Source in the same way through the same place at no further charge. You need not require recipients to copy the Corresponding Source along with the object code. If the place to copy the object code is a network server, the Corresponding Source may be on a different server (operated by you or a third party) that supports equivalent copying facilities, provided you maintain clear directions next to the object code saying where to find the Corresponding Source. Regardless of what server hosts the Corresponding Source, you remain obligated to ensure that it is available for as long as needed to satisfy these requirements.
- e) Convey the object code using peer-to-peer transmission, provided you inform other peers where the object code and Corresponding Source of the work are being offered to the general public at no charge under subsection 6d.

A separable portion of the object code, whose source code is excluded from the Corresponding Source as a System Library, need not be included in conveying the object code work.

A "User Product" is either (1) a "consumer product", which means any tangible personal property which is normally used for personal, family, or household purposes, or (2) anything designed or sold for incorporation into a dwelling. In determining whether a product is a consumer product, doubtful cases shall be resolved in favor of coverage. For a particular product received by a particular user, "normally used" refers to a typical or common use of that class of product, regardless of the status of the particular user or of the way in which the particular user actually uses, or expects or is expected to use, the product. A product is a consumer product regardless of whether the product has substantial commercial, industrial

or non-consumer uses, unless such uses represent the only significant mode of use of the product. "Installation Information" for a User Product means any methods, procedures, authorization keys, or other information required to install and execute modified versions of a covered work in that User Product from a modified version of its Corresponding Source. The information must suffice to ensure that the continued functioning of the modified object code is in no case prevented or interfered with solely because modification has been made.

If you convey an object code work under this section in, or with, or specifically for use in, a User Product, and the conveying occurs as part of a transaction in which the right of possession and use of the User Product is transferred to the recipient in perpetuity or for a fixed term (regardless of how the transaction is characterized), the Corresponding Source conveyed under this section must be accompanied by the Installation Information. But this requirement does not apply if neither you nor any third party retains the ability to install modified object code on the User Product (for example, the work has been installed in ROM). The requirement to provide Installation Information does not include a requirement to continue to provide support service, warranty, or updates for a work that has been modified or installed by the recipient, or for the User Product in which it has been modified or installed. Access to a network may be denied when the modification itself materially and adversely affects the operation of the network or violates the rules and protocols for communication across the network.

Corresponding Source conveyed, and Installation Information provided, in accord with this section must be in a format that is publicly documented (and with an implementation available to the public in source code form), and must require no special password or key for unpacking, reading or copying.

## **7. Additional Terms.**

"Additional permissions" are terms that supplement the terms of this License by making exceptions from one or more of its conditions. Additional permissions that are applicable to the entire Program shall be treated as though they were included in this License, to the extent that they are valid under applicable law. If additional permissions apply only to part of the Program, that part may be used separately under those permissions, but the entire Program remains governed by this License without regard to the additional permissions.

When you convey a copy of a covered work, you may at your option remove any additional permissions from that copy, or from any part of it. (Additional permissions may be written to require their own removal in certain cases when you modify the work.) You may place additional permissions on material, added by you to a covered work, for which you have or can give appropriate copyright permission.

Notwithstanding any other provision of this License, for material you add to a covered work, you may (if authorized by the copyright holders of that material) supplement the terms of this License with terms:

- a) Disclaiming warranty or limiting liability differently from the terms of sections 15 and 16 of this License; or
- b) Requiring preservation of specified reasonable legal notices or author attributions in that material or in the Appropriate Legal Notices displayed by works containing it; or
- c) Prohibiting misrepresentation of the origin of that material, or requiring that modified versions of such material be marked in reasonable ways as different from the original version; or
- d) Limiting the use for publicity purposes of names of licensors or authors of the material; or

- e) Declining to grant rights under trademark law for use of some trade names, trademarks, or service marks; or
- f) Requiring indemnification of licensors and authors of that material by anyone who conveys the material (or modified versions of it) with contractual assumptions of liability to the recipient, for any liability that these contractual assumptions directly impose on those licensors and authors.

All other non-permissive additional terms are considered “further restrictions” within the meaning of section 10. If the Program as you received it, or any part of it, contains a notice stating that it is governed by this License along with a term that is a further restriction, you may remove that term. If a license document contains a further restriction but permits relicensing or conveying under this License, you may add to a covered work material governed by the terms of that license document, provided that the further restriction does not survive such relicensing or conveying.

If you add terms to a covered work in accord with this section, you must place, in the relevant source files, a statement of the additional terms that apply to those files, or a notice indicating where to find the applicable terms.

Additional terms, permissive or non-permissive, may be stated in the form of a separately written license, or stated as exceptions; the above requirements apply either way.

## **8. Termination.**

You may not propagate or modify a covered work except as expressly provided under this License. Any attempt otherwise to propagate or modify it is void, and will automatically terminate your rights under this License (including any patent licenses granted under the third paragraph of section 11).

However, if you cease all violation of this License, then your license from a particular copyright holder is reinstated (a) provisionally, unless and until the copyright holder explicitly and finally terminates your license, and (b) permanently, if the copyright holder fails to notify you of the violation by some reasonable means prior to 60 days after the cessation.

Moreover, your license from a particular copyright holder is reinstated permanently if the copyright holder notifies you of the violation by some reasonable means, this is the first time you have received notice of violation of this License (for any work) from that copyright holder, and you cure the violation prior to 30 days after your receipt of the notice.

Termination of your rights under this section does not terminate the licenses of parties who have received copies or rights from you under this License. If your rights have been terminated and not permanently reinstated, you do not qualify to receive new licenses for the same material under section 10.

## **9. Acceptance Not Required for Having Copies.**

You are not required to accept this License in order to receive or run a copy of the Program. Ancillary propagation of a covered work occurring solely as a consequence of using peer-to-peer transmission to receive a copy likewise does not require acceptance. However, nothing other than this License grants you permission to propagate or modify any covered work. These actions infringe copyright if you do not accept this License. Therefore, by modifying or propagating a covered work, you indicate your acceptance of this License to do so.

## **10. Automatic Licensing of Downstream Recipients.**

Each time you convey a covered work, the recipient automatically receives a license from the original

licensors, to run, modify and propagate that work, subject to this License. You are not responsible for enforcing compliance by third parties with this License.

An “entity transaction” is a transaction transferring control of an organization, or substantially all assets of one, or subdividing an organization, or merging organizations. If propagation of a covered work results from an entity transaction, each party to that transaction who receives a copy of the work also receives whatever licenses to the work the party's predecessor in interest had or could give under the previous paragraph, plus a right to possession of the Corresponding Source of the work from the predecessor in interest, if the predecessor has it or can get it with reasonable efforts.

You may not impose any further restrictions on the exercise of the rights granted or affirmed under this License. For example, you may not impose a license fee, royalty, or other charge for exercise of rights granted under this License, and you may not initiate litigation (including a cross-claim or counterclaim in a lawsuit) alleging that any patent claim is infringed by making, using, selling, offering for sale, or importing the Program or any portion of it.

## **11. Patents.**

A “contributor” is a copyright holder who authorizes use under this License of the Program or a work on which the Program is based. The work thus licensed is called the contributor's “contributor version”.

A contributor's “essential patent claims” are all patent claims owned or controlled by the contributor, whether already acquired or hereafter acquired, that would be infringed by some manner, permitted by this License, of making, using, or selling its contributor version, but do not include claims that would be infringed only as a consequence of further modification of the contributor version. For purposes of this definition, “control” includes the right to grant patent sublicenses in a manner consistent with the requirements of this License.

Each contributor grants you a non-exclusive, worldwide, royalty-free patent license under the contributor's essential patent claims, to make, use, sell, offer for sale, import and otherwise run, modify and propagate the contents of its contributor version.

In the following three paragraphs, a “patent license” is any express agreement or commitment, however denominated, not to enforce a patent (such as an express permission to practice a patent or covenant not to sue for patent infringement). To “grant” such a patent license to a party means to make such an agreement or commitment not to enforce a patent against the party.

If you convey a covered work, knowingly relying on a patent license, and the Corresponding Source of the work is not available for anyone to copy, free of charge and under the terms of this License, through a publicly available network server or other readily accessible means, then you must either (1) cause the Corresponding Source to be so available, or (2) arrange to deprive yourself of the benefit of the patent license for this particular work, or (3) arrange, in a manner consistent with the requirements of this License, to extend the patent license to downstream recipients. “Knowingly relying” means you have actual knowledge that, but for the patent license, your conveying the covered work in a country, or your recipient's use of the covered work in a country, would infringe one or more identifiable patents in that country that you have reason to believe are valid.

If, pursuant to or in connection with a single transaction or arrangement, you convey, or propagate by procuring conveyance of, a covered work, and grant a patent license to some of the parties receiving the

covered work authorizing them to use, propagate, modify or convey a specific copy of the covered work, then the patent license you grant is automatically extended to all recipients of the covered work and works based on it.

A patent license is “discriminatory” if it does not include within the scope of its coverage, prohibits the exercise of, or is conditioned on the non-exercise of one or more of the rights that are specifically granted under this License. You may not convey a covered work if you are a party to an arrangement with a third party that is in the business of distributing software, under which you make payment to the third party based on the extent of your activity of conveying the work, and under which the third party grants, to any of the parties who would receive the covered work from you, a discriminatory patent license

- (a) in connection with copies of the covered work conveyed by you (or copies made from those copies), or
- (b) primarily for and in connection with specific products or compilations that contain the covered work, unless you entered into that arrangement, or that patent license was granted, prior to 28 March 2007.

Nothing in this License shall be construed as excluding or limiting any implied license or other defenses to infringement that may otherwise be available to you under applicable patent law.

## **12. No Surrender of Others' Freedom.**

If conditions are imposed on you (whether by court order, agreement or otherwise) that contradict the conditions of this License, they do not excuse you from the conditions of this License. If you cannot convey a covered work so as to satisfy simultaneously your obligations under this License and any other pertinent obligations, then as a consequence you may not convey it at all. For example, if you agree to terms that obligate you to collect a royalty for further conveying from those to whom you convey the Program, the only way you could satisfy both those terms and this License would be to refrain entirely from conveying the Program.

## **13. Use with the GNU Affero General Public License.**

Notwithstanding any other provision of this License, you have permission to link or combine any covered work with a work licensed under version 3 of the GNU Affero General Public License into a single combined work, and to convey the resulting work. The terms of this License will continue to apply to the part which is the covered work, but the special requirements of the GNU Affero General Public License, section 13, concerning interaction through a network will apply to the combination as such.

## **14. Revised Versions of this License.**

The Free Software Foundation may publish revised and/ or new versions of the GNU General Public License from time to time. Such new versions will be similar in spirit to the present version, but may differ in detail to address new problems or concerns.

Each version is given a distinguishing version number. If the Program specifies that a certain numbered version of the GNU General Public License “or any later version” applies to it, you have the option of following the terms and conditions either of that numbered version or of any later version published by the Free Software Foundation. If the Program does not specify a version number of the GNU General Public License, you may choose any version ever published by the Free Software Foundation.

If the Program specifies that a proxy can decide which future versions of the GNU General Public License can be used, that proxy's public statement of acceptance of a version permanently authorizes you to

choose that version for the Program.

Later license versions may give you additional or different permissions. However, no additional obligations are imposed on any author or copyright holder as a result of your choosing to follow a later version.

#### **15. Disclaimer of Warranty.**

THERE IS NO WARRANTY FOR THE PROGRAM, TO THE EXTENT PERMITTED BY APPLICABLE LAW. EXCEPT WHEN OTHERWISE STATED IN WRITING THE COPYRIGHT HOLDERS AND/OR OTHER PARTIES PROVIDE THE PROGRAM "AS IS" WITHOUT WARRANTY OF ANY KIND, EITHER EXPRESSED OR IMPLIED, INCLUDING, BUT NOT LIMITED TO, THE IMPLIED WARRANTIES OF MERCHANTABILITY AND FITNESS FOR A PARTICULAR PURPOSE. THE ENTIRE RISK AS TO THE QUALITY AND PERFORMANCE OF THE PROGRAM IS WITH YOU. SHOULD THE PROGRAM PROVE DEFECTIVE, YOU ASSUME THE COST OF ALL NECESSARY SERVICING, REPAIR OR CORRECTION.

#### **16. Limitation of Liability.**

IN NO EVENT UNLESS REQUIRED BY APPLICABLE LAW OR AGREED TO IN WRITING WILL ANY COPYRIGHT HOLDER, OR ANY OTHER PARTY WHO MODIFIES AND/OR CONVEYS THE PROGRAM AS PERMITTED ABOVE, BE LIABLE TO YOU FOR DAMAGES, INCLUDING ANY GENERAL, SPECIAL, INCIDENTAL OR CONSEQUENTIAL DAMAGES ARISING OUT OF THE USE OR INABILITY TO USE THE PROGRAM (INCLUDING BUT NOT LIMITED TO LOSS OF DATA OR DATA BEING RENDERED INACCURATE OR LOSSES SUSTAINED BY YOU OR THIRD PARTIES OR A FAILURE OF THE PROGRAM TO OPERATE WITH ANY OTHER PROGRAMS), EVEN IF SUCH HOLDER OR OTHER PARTY HAS BEEN ADVISED OF THE POSSIBILITY OF SUCH DAMAGES.

#### **17. Interpretation of Sections 15 and 16.**

If the disclaimer of warranty and limitation of liability provided above cannot be given local legal effect according to their terms, reviewing courts shall apply local law that most closely approximates an absolute waiver of all civil liability in connection with the Program, unless a warranty or assumption of liability accompanies a copy of the Program in return for a fee.

END OF TERMS AND CONDITIONS

### **GNU LESSER GENERAL PUBLIC LICENSE**

Version 2.1, February 1999

Copyright (C) 1991, 1999 Free Software Foundation, Inc. 51 Franklin Street, Fifth Floor, Boston, MA 02110-1301

USA Everyone is permitted to copy and distribute verbatim copies of this license document, but changing it is not allowed.

[This is the first released version of the Lesser GPL. It also counts as the successor of the GNU Library Public License, version 2, hence the version number 2.1.]

#### **Preamble**

The licenses for most software are designed to take away your freedom to share and change it. By contrast, the GNU General Public Licenses are intended to guarantee your freedom to share and change free software to make sure the software is free for all its users.

This license, the Lesser General Public License, applies to some specially designated software packages--typically libraries--of the Free Software Foundation and other authors who decide to use it. You can use it too, but we suggest you first think carefully about whether this license or the ordinary General Public License is the better strategy to use in any particular case, based on the explanations below.

When we speak of free software, we are referring to freedom of use, not price. Our General Public Licenses are designed to make sure that you have the freedom to distribute copies of free software (and charge for this service if you wish); that you receive source code or can get it if you want it; that you can change the software and use pieces of it in new free programs; and that you are informed that you can do these things.

To protect your rights, we need to make restrictions that forbid distributors to deny you these rights or to ask you to surrender these rights. These restrictions translate to certain responsibilities for you if you distribute copies of the library or if you modify it.

For example, if you distribute copies of the library, whether gratis or for a fee, you must give the recipients all the rights that we gave you. You must make sure that they, too, receive or can get the source code. If you link other code with the library, you must provide complete object files to the recipients, so that they can relink them with the library after making changes to the library and recompiling it. And you must show them these terms so they know their rights.

We protect your rights with a two-step method: (1) we copyright the library, and (2) we offer you this license, which gives you legal permission to copy, distribute and/or modify the library.

To protect each distributor, we want to make it very clear that there is no warranty for the free library. Also, if the library is modified by someone else and passed on, the recipients should know that what they have is not the original version, so that the original author's reputation will not be affected by problems that might be introduced by others.

Finally, software patents pose a constant threat to the existence of any free program. We wish to make sure that a company cannot effectively restrict the users of a free program by obtaining a restrictive license from a patent holder. Therefore, we insist that any patent license obtained for a version of the library must be consistent with the full freedom of use specified in this license.

Most GNU software, including some libraries, is covered by the ordinary GNU General Public License. This license, the GNU Lesser General Public License, applies to certain designated libraries, and is quite different from the ordinary General Public License. We use this license for certain libraries in order to permit linking those libraries into non-free programs.

When a program is linked with a library, whether statically or using a shared library, the combination of the two is legally speaking a combined work, a derivative of the original library. The ordinary General Public License therefore permits such linking only if the entire combination fits its criteria of freedom. The Lesser General Public License permits more lax criteria for linking other code with the library.

We call this license the "Lesser" General Public License because it does Less to protect the user's freedom than the ordinary General Public License. It also provides other free software developers Less of an advantage over competing non-free programs. These disadvantages are the reason we use the ordinary General Public License for many libraries. However, the Lesser license provides advantages in certain special circumstances.

For example, on rare occasions, there may be a special need to encourage the widest possible use of a certain library, so that it becomes a de-facto standard. To achieve this, non-free programs must be allowed to use the library. A more frequent case is that a free library does the same job as widely used non-free libraries. In this case, there is little to gain by limiting the free library to free software only, so we use the Lesser General Public License.

In other cases, permission to use a particular library in non-free programs enables a greater number of people to use a large body of free software. For example, permission to use the GNU C Library in non-free programs enables many more people to use the whole GNU operating system, as well as its variant, the GNU/ Linux operating system.

Although the Lesser General Public License is Less protective of the users' freedom, it does ensure that the user of a program that is linked with the Library has the freedom and the wherewithal to run that program using a modified version of the Library.

The precise terms and conditions for copying, distribution and modification follow. Pay close attention to the difference between a "work based on the library" and a "work that uses the library". The former contains code derived from the library, whereas the latter must be combined with the library in order to run.

## **TERMS AND CONDITIONS FOR COPYING, DISTRIBUTION AND MODIFICATION**

0. This License Agreement applies to any software library or other program which contains a notice placed by the copyright holder or other authorized party saying it may be distributed under the terms of this Lesser General Public License (also called "this License"). Each licensee is addressed as "you". A "library" means a collection of software functions and/ or data prepared so as to be conveniently linked with application programs (which use some of those functions and data) to form executables. The "Library", below, refers to any such software library or work which has been distributed under these terms. A "work based on the Library" means either the Library or any derivative work under copyright law: that is to say, a work containing the Library or a portion of it, either verbatim or with modifications and/or translated straightforwardly into another language. (Hereinafter, translation is included without limitation in the term "modification".)

"Source code" for a work means the preferred form of the work for making modifications to it. For a library, complete source code means all the source code for all modules it contains, plus any associated interface definition files, plus the scripts used to control compilation and installation of the library.

Activities other than copying, distribution and modification are not covered by this License; they are outside its scope. The act of running a program using the Library is not restricted, and output from such a program is covered only if its contents constitute a work based on the Library (independent of the use of the Library in a tool for writing it). Whether that is true depends on what the Library does and what the program that uses the Library does.

1. You may copy and distribute verbatim copies of the Library's complete source code as you receive it, in any medium, provided that you conspicuously and appropriately publish on each copy an appropriate copyright notice and disclaimer of warranty; keep intact all the notices that refer to this License and to the absence of any warranty; and distribute a copy of this License along with the Library.

You may charge a fee for the physical act of transferring a copy, and you may at your option offer warranty protection in exchange for a fee.

2. You may modify your copy or copies of the Library or any portion of it, thus forming a work based on the Library, and copy and distribute such modifications or work under the terms of Section 1 above, provided that you also meet all of these conditions:

- a) The modified work must itself be a software library.
- b) You must cause the files modified to carry prominent notices stating that you changed the files and the date of any change.
- c) You must cause the whole of the work to be licensed at no charge to all third parties under the terms of this License.
- d) If a facility in the modified Library refers to a function or a table of data to be supplied by an application program that uses the facility, other than as an argument passed when the facility is invoked, then you must make a good faith effort to ensure that, in the event an application does not supply such function or table, the facility still operates, and performs whatever part of its purpose remains meaningful. (For example, a function in a library to compute square roots has a purpose that is entirely well-defined independent of the application. Therefore, Subsection 2d requires that any application-supplied function or table used by this function must be optional: if the application does not supply it, the square root function must still compute square roots.) These requirements apply to the modified work as a whole. If identifiable sections of that work are not derived from the Library, and can be reasonably considered independent and separate works in themselves, then this License, and its terms, do not

apply to those sections when you distribute them as separate works. But when you distribute the same sections as part of a whole which is a work based on the Library, the distribution of the whole must be on the terms of this License, whose permissions for other licensees extend to the entire whole, and thus to each and every part regardless of who wrote it.

Thus, it is not the intent of this section to claim rights or contest your rights to work written entirely by you; rather, the intent is to exercise the right to control the distribution of derivative or collective works based on the Library.

In addition, mere aggregation of another work not based on the Library with the Library (or with a work based on the Library) on a volume of a storage or distribution medium does not bring the other work under the scope of this License.

3. You may opt to apply the terms of the ordinary GNU General Public License instead of this License to a given copy of the Library. To do this, you must alter all the notices that refer to this License, so that they refer to the ordinary GNU General Public License, version 2, instead of to this License. (If a newer version than version 2 of the ordinary GNU General Public License has appeared, then you can specify that version instead if you wish.) Do not make any other change in these notices.

Once this change is made in a given copy, it is irreversible for that copy, so the ordinary GNU General Public License applies to all subsequent copies and derivative works made from that copy.

This option is useful when you wish to copy part of the code of the Library into a program that is not a library.

4. You may copy and distribute the Library (or a portion or derivative of it, under Section 2) in object code or executable form under the terms of Sections 1 and 2 above provided that you accompany it with the complete corresponding machine-readable source code, which must be distributed under the terms of Sections 1 and 2 above on a medium customarily used for software interchange.

If distribution of object code is made by offering access to copy from a designated place, then offering

equivalent access to copy the source code from the same place satisfies the requirement to distribute the source code, even though third parties are not compelled to copy the source along with the object code.

5. A program that contains no derivative of any portion of the Library, but is designed to work with the Library by being compiled or linked with it, is called a “work that uses the Library”. Such a work, in isolation, is not a derivative work of the Library, and therefore falls outside the scope of this License. However, linking a “work that uses the Library” with the Library creates an executable that is a derivative of the Library (because it contains portions of the Library), rather than a “work that uses the library”. The executable is therefore covered by this License. Section 6 states terms for distribution of such executables.

When a “work that uses the Library” uses material from a header file that is part of the Library, the object code for the work may be a derivative work of the Library even though the source code is not. Whether this is true is especially significant if the work can be linked without the Library, or if the work is itself a library. The threshold for this to be true is not precisely defined by law.

If such an object file uses only numerical parameters, data structure layouts and accessors, and small macros and small inline functions (ten lines or less in length), then the use of the object file is unrestricted, regardless of whether it is legally a derivative work. (Executables containing this object code plus portions of the Library will still fall under Section 6.)

Otherwise, if the work is a derivative of the Library, you may distribute the object code for the work under the terms of Section 6. Any executables containing that work also fall under Section 6, whether or not they are linked directly with the Library itself.

6. As an exception to the Sections above, you may also combine or link a “work that uses the Library” with the Library to produce a work containing portions of the Library, and distribute that work under terms of your choice, provided that the terms permit modification of the work for the customer’s own use and reverse engineering for debugging such modifications.

You must give prominent notice with each copy of the work that the Library is used in it and that the Library and its use are covered by this License. You must supply a copy of this License. If the work during execution displays copyright notices, you must include the copyright notice for the Library among them, as well as a reference directing the user to the copy of this License. Also, you must do one of these things:

- a) Accompany the work with the complete corresponding machine-readable source code for the Library including whatever changes were used in the work (which must be distributed under Sections 1 and 2 above); and, if the work is an executable linked with the Library, with the complete machine readable “work that uses the Library”, as object code and/or source code, so that the user can modify the Library and then relink to produce a modified executable containing the modified Library. (It is understood that the user who changes the contents of definitions files in the Library will not necessarily be able to recompile the application to use the modified definitions.)
- b) Use a suitable shared library mechanism for linking with the Library. A suitable mechanism is one that (1) uses at run time a copy of the library already present on the user’s computer system, rather than copying library functions into the executable, and (2) will operate properly with a modified version of the library, if the user installs one, as long as the modified version is interface-compatible with the version that the work was made with.

- c) Accompany the work with a written offer, valid for at least three years, to give the same user the materials specified in Subsection 6a, above, for a charge no more than the cost of performing this distribution.
- d) If distribution of the work is made by offering access to copy from a designated place, offer equivalent access to copy the above specified materials from the same place.
- e) Verify that the user has already received a copy of these materials or that you have already sent this user a copy.

For an executable, the required form of the “work that uses the Library” must include any data and utility programs needed for reproducing the executable from it. However, as a special exception, the materials to be distributed need not include anything that is normally distributed (in either source or binary form) with the major components (compiler, kernel, and so on) of the operating system on which the executable runs, unless that component itself accompanies the executable.

It may happen that this requirement contradicts the license restrictions of other proprietary libraries that do not normally accompany the operating system. Such a contradiction means you cannot use both them and the Library together in an executable that you distribute.

7. You may place library facilities that are a work based on the Library side-by-side in a single library together with other library facilities not covered by this License, and distribute such a combined library, provided that the separate distribution of the work based on the Library and of the other library facilities is otherwise permitted, and provided that you do these two things:
  - a) Accompany the combined library with a copy of the same work based on the Library, uncombined with any other library facilities. This must be distributed under the terms of the Sections above.
  - b) Give prominent notice with the combined library of the fact that part of it is a work based on the Library, and explaining where to find the accompanying uncombined form of the same work.
8. You may not copy, modify, sublicense, link with, or distribute the Library except as expressly provided under this License. Any attempt otherwise to copy, modify, sublicense, link with, or distribute the Library is void, and will automatically terminate your rights under this License. However, parties who have received copies, or rights, from you under this License will not have their licenses terminated so long as such parties remain in full compliance.
9. You are not required to accept this License, since you have not signed it. However, nothing else grants you permission to modify or distribute the Library or its derivative works. These actions are prohibited by law if you do not accept this License. Therefore, by modifying or distributing the Library (or any work based on the Library), you indicate your acceptance of this License to do so, and all its terms and conditions for copying, distributing or modifying the Library or works based on it.
10. Each time you redistribute the Library (or any work based on the Library), the recipient automatically receives a license from the original licensor to copy, distribute, link with or modify the Library subject to these terms and conditions. You may not impose any further restrictions on the recipients’ exercise of the rights granted herein. You are not responsible for enforcing compliance by third parties with this License.
11. If, as a consequence of a court judgment or allegation of patent infringement or for any other reason (not limited to patent issues), conditions are imposed on you (whether by court order, agreement or

otherwise) that contradict the conditions of this License, they do not excuse you from the conditions of this License. If you cannot distribute so as to satisfy simultaneously your obligations under this License and any other pertinent obligations, then as a consequence you may not distribute the Library at all. For example, if a patent license would not permit royalty free redistribution of the Library by all those who receive copies directly or indirectly through you, then the only way you could satisfy both it and this License would be to refrain entirely from distribution of the Library. If any portion of this section is held invalid or unenforceable under any particular circumstance, the balance of the section is intended to apply, and the section as a whole is intended to apply in other circumstances.

It is not the purpose of this section to induce you to infringe any patents or other property right claims or to contest validity of any such claims; this section has the sole purpose of protecting the integrity of the free software distribution system which is implemented by public license practices. Many people have made generous contributions to the wide range of software distributed through that system in reliance on consistent application of that system; it is up to the author/donor to decide if he or she is willing to distribute software through any other system and a licensee cannot impose that choice. This section is intended to make thoroughly clear what is believed to be a consequence of the rest of this License.

12. If the distribution and/or use of the Library is restricted in certain countries either by patents or by copyrighted interfaces, the original copyright holder who places the Library under this License may add an explicit geographical distribution limitation excluding those countries, so that distribution is permitted only in or among countries not thus excluded. In such case, this License incorporates the limitation as if written in the body of this License.
13. The Free Software Foundation may publish revised and/or new versions of the Lesser General Public License from time to time. Such new versions will be similar in spirit to the present version, but may differ in detail to address new problems or concerns.  
Each version is given a distinguishing version number. If the Library specifies a version number of this License which applies to it and “any later version”, you have the option of following the terms and conditions either of that version or of any later version published by the Free Software Foundation. If the Library does not specify a license version number, you may choose any version ever published by the Free Software Foundation.
14. If you wish to incorporate parts of the Library into other free programs whose distribution conditions are incompatible with these, write to the author to ask for permission. For software which is copyrighted by the Free Software Foundation, write to the Free Software Foundation; we sometimes make exceptions for this. Our decision will be guided by the two goals of preserving the free status of all derivatives of our free software and of promoting the sharing and reuse of software generally.

## **NO WARRANTY**

15. BECAUSE THE LIBRARY IS LICENSED FREE OF CHARGE, THERE IS NO WARRANTY FOR THE LIBRARY, TO THE EXTENT PERMITTED BY APPLICABLE LAW. EXCEPT WHEN OTHERWISE STATED IN WRITING THE COPYRIGHT HOLDERS AND/OR OTHER PARTIES PROVIDE THE LIBRARY “AS IS”

WITHOUT WARRANTY OF ANY KIND, EITHER EXPRESSED OR IMPLIED, INCLUDING, BUT NOT LIMITED TO, THE IMPLIED WARRANTIES OF MERCHANTABILITY AND FITNESS FOR A PARTICULAR PURPOSE. THE ENTIRE RISK AS TO THE QUALITY AND PERFORMANCE OF THE LIBRARY IS WITH YOU. SHOULD THE LIBRARY PROVE DEFECTIVE, YOU ASSUME THE COST OF ALL NECESSARY SERVICING, REPAIR OR CORRECTION.

16. IN NO EVENT UNLESS REQUIRED BY APPLICABLE LAW OR AGREED TO IN WRITING WILL ANY COPYRIGHT HOLDER, OR ANY OTHER PARTY WHO MAY MODIFY AND/OR REDISTRIBUTE THE LIBRARY AS PERMITTED ABOVE, BE LIABLE TO YOU FOR DAMAGES, INCLUDING ANY GENERAL, SPECIAL, INCIDENTAL OR CONSEQUENTIAL DAMAGES ARISING OUT OF THE USE OR INABILITY TO USE THE LIBRARY (INCLUDING BUT NOT LIMITED TO LOSS OF DATA OR DATA BEING RENDERED INACCURATE OR LOSSES SUSTAINED BY YOU OR THIRD PARTIES OR A FAILURE OF THE LIBRARY TO OPERATE WITH ANY OTHER SOFTWARE), EVEN IF SUCH HOLDER OR OTHER PARTY HAS BEEN ADVISED OF THE POSSIBILITY OF SUCH DAMAGES.
- END OF TERMS AND CONDITIONS

### How to Apply These Terms to Your New Libraries

If you develop a new library, and you want it to be of the greatest possible use to the public, we recommend making it free software that everyone can redistribute and change. You can do so by permitting redistribution under these terms (or, alternatively, under the terms of the ordinary General Public License).

To apply these terms, attach the following notices to the library. It is safest to attach them to the start of each source file to most effectively convey the exclusion of warranty; and each file should have at least the "copyright" line and a pointer to where the full notice is found. one line to give the library's name and an idea of what it does.

Copyright (C) year name of author

This library is free software; you can redistribute it and/ or modify it under the terms of the GNU Lesser General Public License as published by the Free Software Foundation; either version 2.1 of the License, or (at your option) any later version.

This library is distributed in the hope that it will be useful, but WITHOUT ANY WARRANTY; without even the implied warranty of MERCHANTABILITY or FITNESS FOR A PARTICULAR PURPOSE. See the GNU Lesser General Public License for more details.

You should have received a copy of the GNU Lesser General Public License along with this library; if not, write to the Free Software Foundation, Inc., 51 Franklin Street, Fifth Floor, Boston, MA 02110-1301 USA Also add information on how to contact you by electronic and paper mail.

You should also get your employer (if you work as a programmer) or your school, if any, to sign a "copyright disclaimer" for the library, if necessary. Here is a sample; alter the names:

Yoyodyne, Inc., hereby disclaims all copyright interest in the library 'Frob' (a library for tweaking knobs) written by James Random Hacker.

signature of Ty Coon, 1 April 1990 Ty Coon, President of Vice.

## OpenSSL LICENSE

Copyright (c) 1998-2006 The OpenSSL Project. All rights reserved. Redistribution and use in source and binary forms, with or without modification, are permitted provided that the following conditions are met:

1. Redistributions of source code must retain the above copyright notice, this list of conditions and the following disclaimer.
2. Redistributions in binary form must reproduce the above copyright notice, this list of conditions and the following disclaimer in the documentation and/or other materials provided with the distribution.
3. All advertising materials mentioning features or use of this software must display the following acknowledgment: "This product includes software developed by the OpenSSL Project for use in the OpenSSL Toolkit. (<http://www.openssl.org/>)"
4. The names "OpenSSL Toolkit" and "OpenSSL Project" must not be used to endorse or promote products derived from this software without prior written permission. For written permission, please contact [openssl-core@openssl.org](mailto:openssl-core@openssl.org).
5. Products derived from this software may not be called "OpenSSL" nor may "OpenSSL" appear in their names without prior written permission of the OpenSSL Project.
6. Redistributions of any form whatsoever must retain the following acknowledgment: "This product includes software developed by the OpenSSL Project for use in the OpenSSL Toolkit (<http://www.openssl.org/>)"

THIS SOFTWARE IS PROVIDED BY THE OpenSSL PROJECT "AS IS" AND ANY EXPRESSED OR IMPLIED WARRANTIES, INCLUDING, BUT NOT LIMITED TO, THE IMPLIED WARRANTIES OF MERCHANTABILITY AND FITNESS FOR A PARTICULAR PURPOSE ARE DISCLAIMED. IN NO EVENT SHALL THE OpenSSL PROJECT OR ITS CONTRIBUTORS BE LIABLE FOR ANY DIRECT, INDIRECT, INCIDENTAL, SPECIAL, EXEMPLARY, OR CONSEQUENTIAL DAMAGES (INCLUDING, BUT NOT LIMITED TO, PROCUREMENT OF SUBSTITUTE GOODS OR SERVICES; LOSS OF USE, DATA, OR PROFITS; OR BUSINESS INTERRUPTION) HOWEVER CAUSED AND ON ANY THEORY OF LIABILITY, WHETHER IN CONTRACT, STRICT LIABILITY, OR TORT (INCLUDING NEGLIGENCE OR OTHERWISE) ARISING IN ANY WAY OUT OF THE USE OF THIS SOFTWARE, EVEN IF ADVISED OF THE POSSIBILITY OF SUCH DAMAGE. This product includes cryptographic software written by Eric Young ([ey@cryptsoft.com](mailto:ey@cryptsoft.com)). This product includes software written by Tim Hudson ([tjh@cryptsoft.com](mailto:tjh@cryptsoft.com)).

### Original SSLeay License

Copyright (C) 1995-1998 Eric Young ([ey@cryptsoft.com](mailto:ey@cryptsoft.com)) All rights reserved. This package is an SSL implementation written by Eric Young ([ey@cryptsoft.com](mailto:ey@cryptsoft.com)). The implementation was written so as to conform with Netscapes SSL. This library is free for commercial and non-commercial use as long as the following conditions are adhered to. The following conditions apply to all code found in this distribution, be it the RC4, RSA, lhash, DES, etc., code; not just the SSL code. The SSL documentation included with this distribution is covered by the same copyright terms except that the holder is Tim Hudson ([tjh@cryptsoft.com](mailto:tjh@cryptsoft.com)).

Copyright remains Eric Young's, and as such any Copyright notices in the code are not to be removed. If this package is used in a product, Eric Young should be given attribution as the author of the parts of the library used. This can be in the form of a textual message at program startup or in documentation (online

or textual) provided with the package. Redistribution and use in source and binary forms, with or without modification, are permitted provided that the following conditions are met:

1. Redistributions of source code must retain the copyright notice, this list of conditions and the following disclaimer.
2. Redistributions in binary form must reproduce the above copyright notice, this list of conditions and the following disclaimer in the documentation and/or other materials provided with the distribution.
3. All advertising materials mentioning features or use of this software must display the following acknowledgement: "This product includes cryptographic software written by Eric Young (eay@cryptsoft.com)" The word 'cryptographic' can be left out if the routines from the library being used are not cryptographic related :-).
4. If you include any Windows specific code (or a derivative thereof) from the apps directory (application code) you must include an acknowledgement: "This product includes software written by Tim Hudson (tjh@cryptsoft.com)"

THIS SOFTWARE IS PROVIDED BY ERIC YOUNG "AS IS" AND ANY EXPRESS OR IMPLIED WARRANTIES, INCLUDING, BUT NOT LIMITED TO, THE IMPLIED WARRANTIES OF MERCHANTABILITY AND FITNESS FOR A PARTICULAR PURPOSE ARE DISCLAIMED. IN NO EVENT SHALL THE AUTHOR OR CONTRIBUTORS BE LIABLE FOR ANY DIRECT, INDIRECT, INCIDENTAL, SPECIAL, EXEMPLARY, OR CONSEQUENTIAL DAMAGES (INCLUDING, BUT NOT LIMITED TO, PROCUREMENT OF SUBSTITUTE GOODS OR SERVICES; LOSS OF USE, DATA, OR PROFITS; OR BUSINESS INTERRUPTION) HOWEVER CAUSED AND ON ANY THEORY OF LIABILITY, WHETHER IN CONTRACT, STRICT LIABILITY, OR TORT (INCLUDING NEGLIGENCE OR OTHERWISE) ARISING IN ANY WAY OUT OF THE USE OF THIS SOFTWARE, EVEN IF ADVISED OF THE POSSIBILITY OF SUCH DAMAGE.

The licence and distribution terms for any publically available version or derivative of this code cannot be changed. i.e. this code cannot simply be copied and put under another distribution licence [including the GNU Public Licence.



www.use-ip.co.uk  
01304 827609

## SALES NETWORK

---

### **SAMSUNG TECHWIN CO., LTD.**

Samsungtechwin R&D Center, 701, Sampyeong-dong, Bundang-gu, Seongnam-si, Gyeonggi-do, Korea, 463-400  
TEL : +82-70-7147-8740~60 FAX : +82-31-8018-3745

### **SAMSUNG TECHWIN AMERICA Inc.**

1480 Charles Willard St, Carson, CA 90746, UNITED STATES  
Tol Free : +1-877-213-1222 FAX : +1-310-632-2195  
www.samsungcctvusa.com

### **SAMSUNG TECHWIN EUROPE LTD.**

Samsung House, 1000 Hillswood Drive, Hillswood Business  
Park Chertsey, Surrey, UNITED KINGDOM KT16 OPS  
TEL : +44-1932-45-5300 FAX : +44-1932-45-5325

---

[www.samsungtechwin.com](http://www.samsungtechwin.com)  
[www.samsungsecurity.com](http://www.samsungsecurity.com)  
[www.samsungipolis.com](http://www.samsungipolis.com)

P/No. : Z6809129301A