

Outdoor • H.264 • Day/Night • Weather-proof

## NETWORK CAMERA

# Quick Installation Guide

English | 繁體中文 | 简体中文 | 日本語 | Français | Español | Deutsch | Português | Italiano | Türkçe | Polski | Русский | Česky | Svenska | العربية



**IP8330**

*Supreme Night Visibility*  
60 fps @ VGA



**IP8332**

*Megapixel*

This guide describes the basic functions of IP8330 / IP8332.  
All detailed information is described in the user's manual.

# Warning Before Installation

● Power off the Network Camera as soon as smoke or unusual odors are detected.

 Contact your distributor in the event of occurrence.

● Refer to your user's manual for the operating temperature.

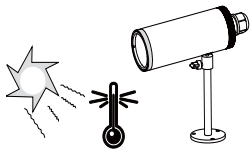

● Do not place the Network Camera on unsteady surfaces.

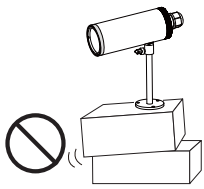

● Do not touch the Network Camera during a lightning storm.

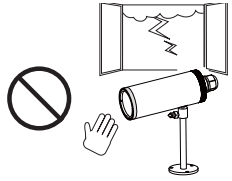

● Do not insert sharp or tiny objects into the Network Camera.



● Do not drop the Network Camera.

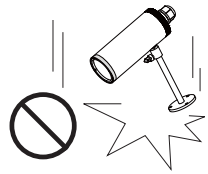

## 1

## Package Contents

- IP8330 / IP8332

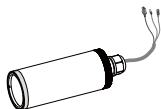

- Waterproof Connector (3 holes, for backup use)



- Silica Gel



- Camera Stand

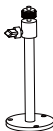

- Power Adapter



- RJ45 Female/Female Coupler

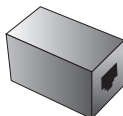

- Quick Installation Guide / Warranty Card



- Software CD



## 2 Physical Description

### ● Front Panel

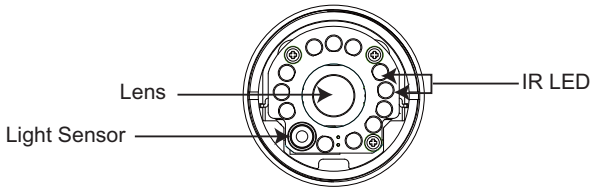

### ● Inner View

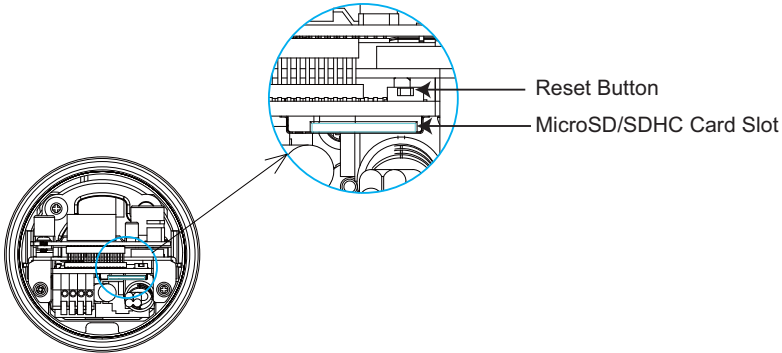

### ● Connectors

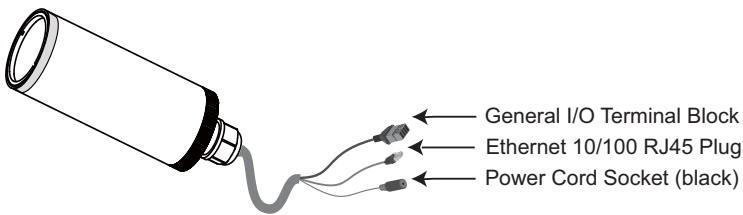

## 3

## Hardware Installation

1. Loosen the waterproof connector, then remove the rubber. 
2. Loosen the back cover.
3. Tear down the aluminum foil vacuum bag and take out the silica gel. Attach the supplied silica gel to the inner side of the Network Camera. (Please replace the silica gel with a new one if you open the back cover after installation.)
4. Make sure all cable lines are securely connected.
5. Tighten the back cover, rubber and waterproof connector.
6. Secure the Network Camera to the wall/ceiling by the supplied camera stand.

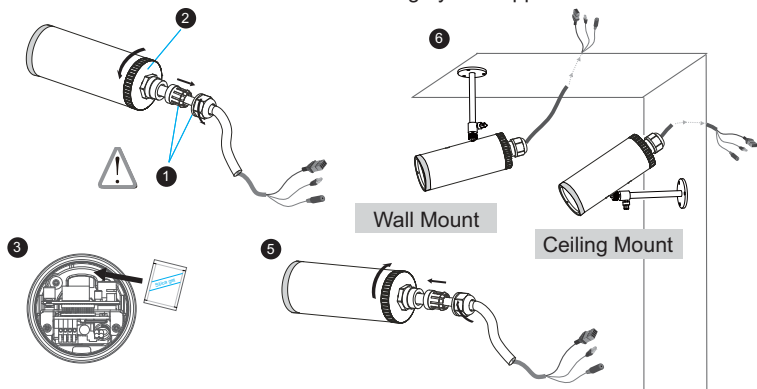
**Note**

If you want to use your own cable lines, please loosen two supplied screws and take out the power board. Then be careful to make connections as the illustration shown below.

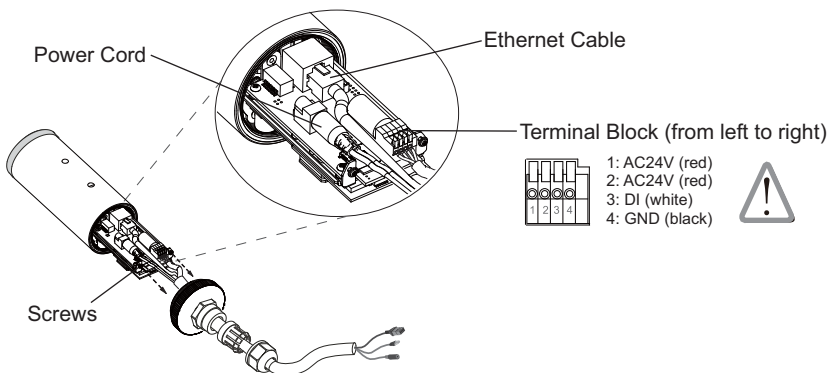

## 4

## Network Deployment

**General Connection (without PoE)**

1. If you have external devices such as sensors and alarms, make the connection from general I/O terminal block.

GND		GND : Ground
DI		DI : Digital Input
AC24V		AC24V: 24V
AC24V		AC24V: 24V

2. Use the supplied RJ45 female/female coupler to connect the Network Camera to a switch.  
Use Category 5 Cross Cable when Network Camera is directly connected to PC.

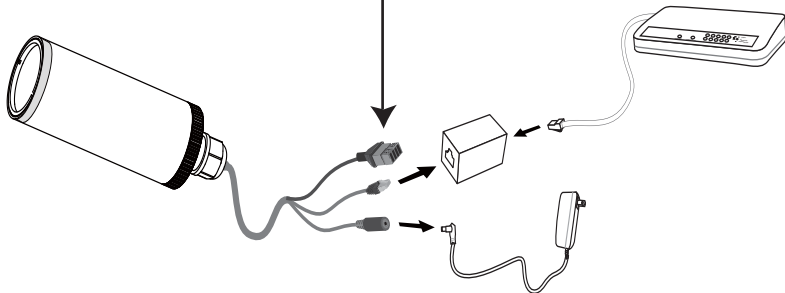

3. Connect the power cable from the Network Camera to a power outlet.

## Power over Ethernet (PoE)

### ● When using a PoE-enabled switch

The Network Camera is PoE-compliant, allowing transmission of power and data via a single Ethernet cable. Follow the below illustration to connect the Network Camera to a PoE-enabled switch via Ethernet cable.

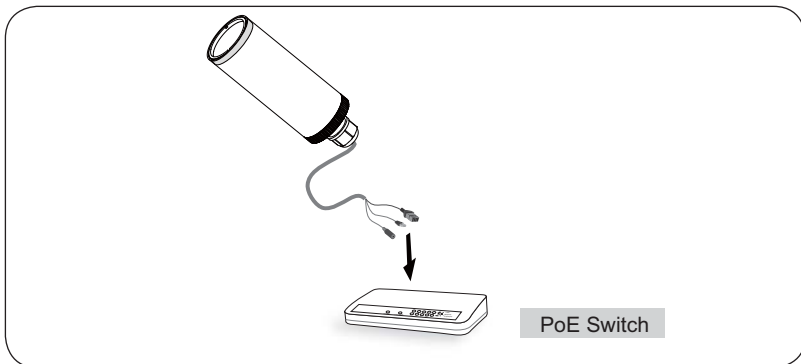

### ● When using a non-PoE switch

Use a PoE power injector (optional) to connect between the Network Camera and a non-PoE switch.

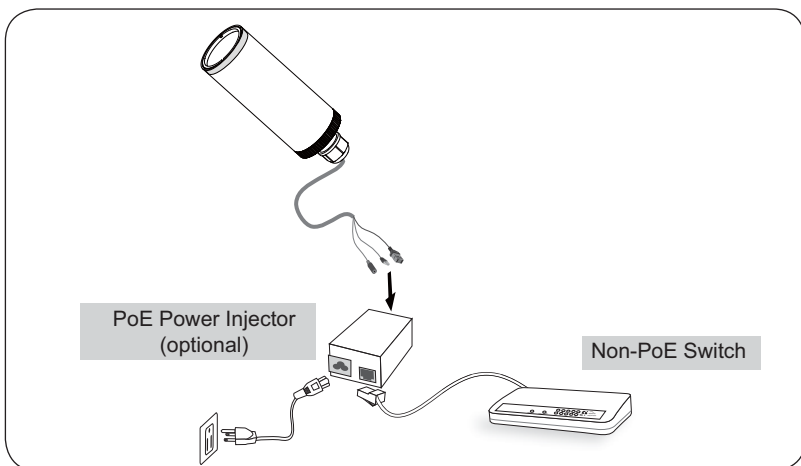

## 5 Assigning an IP Address

1. Install "Installation Wizard 2" from the Software Utility directory on the software CD.
2. The program will conduct an analysis of your network environment. After your network is analyzed, please click on the "Next" button to continue the program.



3. The program will search for all VIVOTEK Video Receivers, Video Servers, and Network Cameras on the same LAN.
4. After searching, the main installer window will pop up. Click on the MAC that matches the one labeled on the bottom of your device to connect to the Network Camera via Internet Explorer.



## 6

## Ready to Use

1. Access the Network Camera from the LAN.
2. Retrieve live video through web browsers or recording software.



For further setup, please refer to the user's manual on the software CD.



[www.use-ip.co.uk](http://www.use-ip.co.uk)  
01304 827609



P/N: 625010600G Ver.1.0  
Copyright © 2010 VIVOTEK INC. All right reserved.

6F, No.192, Lien-Cheng Rd., Chung-Ho, Taipei County, Taiwan | T: +886 2 82455282 | F: +886 2 82455532 | E: sales@vivotek.com