

**DS-2CD2546G2-I(W)**  
**4 MP AcuSense EXIR Fixed Mini Dome Network Camera**

AcuSense



Empowered by deep learning algorithms, Hikvision AcuSense technology brings human and vehicle targets classification alarms to front- and back-end devices. The system focuses on human and vehicle targets, vastly improving alarm efficiency and effectiveness.

- High quality imaging with 4 MP resolution
- Excellent low-light performance with powered-by-DarkFighter technology
- Focusing on human and vehicle classification based on deep learning
- Clear imaging against strong back light due to 120 dB WDR technology
- Efficient H.265+ compression technology
- -S: audio and alarm interface available
- -W: Realizing Wi-Fi connection and easy installation
- Water and dust resistant IP67 and vandal proof IK08



## ▪ Specification

Camera	
Image Sensor	1/3" Progressive Scan CMOS
Max. Resolution	2688 × 1520
Min. Illumination	Color: 0.003 Lux @ (F1.4, AGC ON), B/W: 0 Lux with IR
Shutter Speed	1/3 s to 1/100,000 s
Day & Night	IR cut filter
Angle Adjustment	Pan: -30° to 30°, tilt: 0° to 75°, rotate: 0° to 360°
Lens	
Lens Type	Fixed focal lens, 2.8 and 4 mm optional
Focal Length & FOV	2.8 mm, horizontal FOV 102.7°, vertical FOV 55.2°, diagonal FOV 122.5° 4 mm, horizontal FOV 82.8°, vertical FOV 45.3°, diagonal FOV 97.7°
Lens Mount	M12
Iris Type	Fixed
Aperture	F1.4
Depth of Field	2.8 mm: 1.6 m to ∞ 4 mm: 2.1 m to ∞
DORI	
DORI	2.8 mm: D: 64 m O: 26 m R: 13 m I: 6 m 4 mm: D: 77 m O: 31 m R: 16 m I: 8 m
Illuminator	
Supplement Light Type	IR
Supplement Light Range	Up to 30 m
Smart Supplement Light	Yes
IR Wavelength	850 nm
Video	
Main Stream	50 Hz: 25 fps (2688 × 1520, 1920 × 1080, 1280 × 720) 60 Hz: 30 fps (2688 × 1520, 1920 × 1080, 1280 × 720)
Sub-Stream	50 Hz: 25 fps (640 × 480, 640 × 360) 60 Hz: 30 fps (640 × 480, 640 × 360)
Third Stream	50 Hz: 10 fps (1920 × 1080, 1280 × 720, 640 × 480, 640 × 360) 60 Hz: 10 fps (1920 × 1080, 1280 × 720, 640 × 480, 640 × 360) *Third stream is supported under certain settings.
Video Compression	Main stream: H.265/H.264/H.265+/H.264+ Sub-stream: H.265/H.264/MJPEG Third stream: H.265/H.264 *Third stream is supported under certain settings.

Video Bit Rate	32 Kbps to 8 Mbps
H.264 Type	Baseline Profile/Main Profile/High Profile
H.265 Type	Main Profile
Bit Rate Control	CBR/VBR
Scalable Video Coding (SVC)	H.264 and H.265 encoding
Region of Interest (ROI)	1 fixed region for main stream and sub-stream
<b>Audio</b>	
Audio Type	Mono sound/2 channels/stereo
Environment Noise Filtering	Yes/No
Audio Sampling Rate	8 kHz/16 kHz/32 kHz/44.1 kHz/48 kHz
Audio Compression	G.711/G.722.1/G.726/MP2L2/PCM/MP3
Audio Bit Rate	64 Kbps (G.711)/16 Kbps (G.722.1)/16 Kbps (G.726)/32 to 192 Kbps (MP2L2)/32 Kbps (PCM)/8 to 320 Kbps (MP3)
<b>Network</b>	
Simultaneous Live View	Up to 6 channels
API	Open Network Video Interface (PROFILE S, PROFILE G, PROFILE T), ISAPI, SDK
Protocols	TCP/IP, ICMP, HTTP, HTTPS, FTP, DHCP, DNS, DDNS, RTP, RTSP, NTP, UPnP, SMTP, IGMP, 802.1 (except for -W model), QoS, IPv4, IPv6, UDP, Bonjour, SSL/TLS, PPPoE, SNMP, ARP, WebSocket, WebSockets
User/Host	Up to 32 users. 3 user levels: administrator, operator and user
Security	Password protection, complicated password, HTTPS encryption, IP address filter, Security Audit Log, basic and digest authentication for HTTP/HTTPS, TLS 1.1/1.2, WSSE and digest authentication for Open Network Video Interface
Network Storage	NAS (NFS, SMB/CIFS), auto network replenishment (ANR) Together with high-end Hikvision memory card, memory card encryption and health detection are supported
Client	iVMS-4200, Hik-Connect, Hik-Central
Web Browser	Plug-in required live view: IE 10+ Plug-in free live view: Chrome 57.0+, Firefox 52.0+ Local service: Chrome 57.0+, Firefox 52.0+
<b>Wi-Fi</b>	
Encryption Mode	-W: 64/128-bit WEP, WPA-EAP/WPA2-EAP, WPA-PSK/WPA2-PSK
Wi-Fi Protocol	-W: 802.11b: CCK, QPSK, BPSK 802.11g/n: OFDM
Frequency Range	-W: 2.4 GHz to 2.4835 GHz
Channel Bandwidth	-W: 20/40 MHz
Modulation	-W: 802.11b: CCK, QPSK, BPSK 802.11g/n: OFDM
Transfer Rate	-W: 802.11b: 11 Mbps 802.11g: 54 Mbps 802.11n: up to 300 Mbps
Wireless Range	-W: Up to 80 m (The performance varies based on actual environment)

Image	
Wide Dynamic Range (WDR)	120 dB
SNR	≥ 52 dB
Day/Night Switch	Day, Night, Auto, Schedule
Image Enhancement	BLC, HLC, 3D DNR
Image Parameters Switch	Yes
Image Settings	Rotate, saturation, brightness, contrast, sharpness, gain, white balance adjustable by client software or web browser
Interface	
Ethernet Interface	1 RJ45 10 M/100 M self-adaptive Ethernet port
On-Board Storage	Built-in memory card slot, support microSD card, up to 256 GB
Built-in Microphone	Yes
Audio	-IS/IWS: 1 input (line in), two-core terminal block, max. input amplitude: 3.3 Vpp, input impedance: 4.7 KΩ, interface type: non-equilibrium 1 output (line out), two-core terminal block, max. output amplitude: 3.3 Vpp, output impedance: 100 Ω, interface type: non-equilibrium
Alarm	-IS/IWS: 1 input, 1 output (max. 12 VDC, 20 mA)
Reset Key	Yes
Event	
Basic Event	Motion detection (human and vehicle targets classification), video tampering alarm, exception
Linkage	Upload to FTP/NAS/memory card, notify surveillance center, trigger recording, trigger capture, send email
Smart Event	Line crossing detection, intrusion detection, region entrance detection, region exiting detection Scene change detection
Deep Learning Function	
Face Capture	Yes
Perimeter Protection	Line crossing, intrusion, region entrance, region exiting Support alarm triggering by specified target types (human and vehicle)
General	
Power	-IS: 12 VDC ± 25%, 0.45 A, max. 5.5 W, Ø5.5 mm coaxial power plug, reverse polarity protection PoE: 802.3af, Class 3, 36 V to 57 V, 0.18 A to 0.11 A, max. 6.5 W -IWS: 12 VDC ± 25%, 0.5 A, max. 6 W, Ø5.5 mm coaxial power plug, reverse polarity protection PoE: 802.3af, Class 3, 36 V to 57 V, 0.19 A to 0.12 A, max. 7 W
Material	Base: aluminum, cover: plastic
Dimension	Ø110 mm × 57.4 mm (Ø 4.3" × 2.3")
Package Dimension	134 mm × 134 mm × 108 mm (5.3" × 5.3" × 4.3")
Weight	Approx. 380 g (0.8 lb.)
With Package Weight	Approx. 620 g (1.4 lb.)

Storage Conditions	-30 °C to 60 °C (-22 °F to 140 °F). Humidity 95% or less (non-condensing)
Startup and Operating Conditions	-30 °C to 60 °C (-22 °F to 140 °F). Humidity 95% or less (non-condensing)
Language	33 languages: English, Russian, Estonian, Bulgarian, Hungarian, Greek, German, Italian, Czech, Slovak, French, Polish, Dutch, Portuguese, Spanish, Romanian, Danish, Swedish, Norwegian, Finnish, Croatian, Slovenian, Serbian, Turkish, Korean, Traditional Chinese, Thai, Vietnamese, Japanese, Latvian, Lithuanian, Portuguese (Brazil), Ukrainian
General Function	Anti-flicker, heartbeat, mirror, privacy mask, flash log, password reset via email, pixel counter
<b>Approval</b>	
RF	-W: FCC ID (FCC Part 15.247(BT or 2.4G)); CE-RED (EN 301489-1 V2.1.1(BT or 2.4G); EN 301489-17 V3.1.1(BT or 2.4G); EN 300328 V2.1.1(BT or 2.4G); EN 62311:2008(BT or 2.4G))
EMC	FCC (47 CFR Part 15, Subpart B) CE-EMC (EN 55032: 2015, EN 61000-3-2: 2019, EN 61000-3-3: 2013+A1: 2019, EN 50130-4: 2011+A1: 2014) RCM (AS/NZS CISPR 32: 2015) IC (ICES-003: Issue 7) KC (KN32: 2015, KN35: 2015)
Safety	UL (UL 62368-1) CB (IEC 62368-1: 2014+A11) CE-LVD (EN 62368-1: 2014/A11: 2017) LOA (IEC/EN 60950-1)
Environment	CE-RoHS (2011/65/EU) WEEE (2012/19/EU) Reach (Regulation (EC) No 1907/2006)
Protection	IP67 (IEC 60529-2013) IK8 (IEC 62262:2002)

### ▪ Available Model

DS-2CD2546G2-IS (2.8/4 mm)

DS-2CD2546G2-I (2.8/4 mm)

DS-2CD2546G2-IS (2.8 mm) (Black)



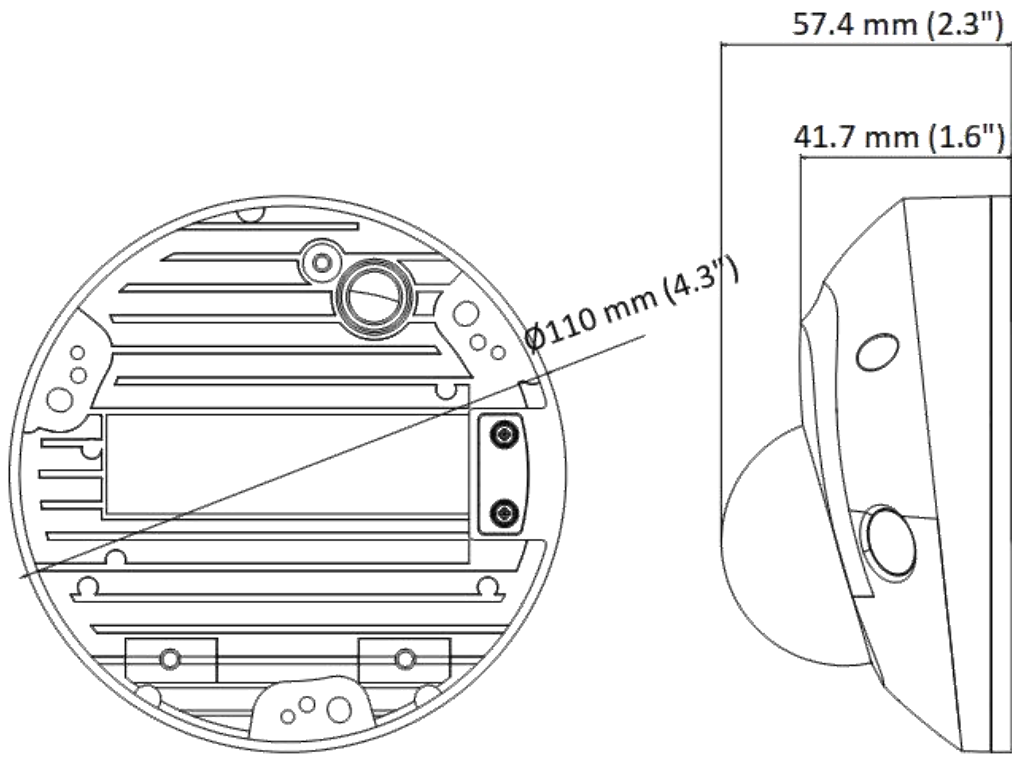



### ▪ Dimension



Unit: mm (inch)

▪ Accessory

▪ Optional

<p><b>DS-1276ZJ-SUS</b> (Black) <b>Corner Mount</b></p> 	<p><b>DS-1280ZJ-DM46(Black)</b> <b>Junction Box</b></p> 	<p><b>DS-1272ZJ-120</b> <b>Wall Mount</b></p> 	<p><b>DS-1280ZJ-DM46</b> <b>Junction Box</b></p> 	<p><b>DS-1275ZJ-SUS</b> <b>Vertical Pole Mount</b></p> 
<p><b>DS-1272ZJ-120B</b> <b>Wall mount</b></p> 	<p><b>DS-1275ZJ-SUS</b> (Black) <b>Vertical Pole Mount</b></p> 	<p><b>DS-1271ZJ-120</b> (Black) <b>Pendant Mount</b></p> 	<p><b>DS-1276ZJ-SUS</b> <b>Corner Mount</b></p> 	<p><b>DS-1271ZJ-120</b> <b>Pendant Mount</b></p> 

Distributed by

## HIKVISION®

**Headquarters**

No.555 Qianmo Road, Binjiang District,  
Hangzhou 310051, China  
T +86-571-8807-5998  
overseasbusiness@hikvision.com

**Hikvision USA**  
T +1-909-895-0400  
sales.usa@hikvision.com

**Hikvision Australia**  
T +61-2-8599-4233  
salesau@hikvision.com

**Hikvision India**  
T +91-22-28469900  
sales@pramahikvision.com

**Hikvision Canada**  
T +1-866-200-6690  
sales.canada@hikvision.com

**Hikvision Thailand**  
T +662-275-9949  
sales.thailand@hikvision.com

**Hikvision Europe**  
T +31-23-5542770  
sales.eu@hikvision.com

**Hikvision Italy**  
T +39-0438-6902  
info.it@hikvision.com

**Hikvision Brazil**  
T +55 11 3318-0050  
Latam.support@hikvision.com

**Hikvision Turkey**  
T +90 (216)521 7070- 7074  
sales.tr@hikvision.com

**Hikvision Malaysia**  
T +601-7652-2413  
sales.my@hikvision.com

**Hikvision UK & Ireland**  
T +01628-902140  
sales.uk@hikvision.com

**Hikvision South Africa**  
Tel: +27 (10) 0351172  
sale.africa@hikvision.com

**Hikvision France**  
T +33(0)1-85-330-450  
info.fr@hikvision.com

**Hikvision Kazakhstan**  
T +7-727-9730667  
nikia.panfilov@hikvision.ru

**Hikvision Vietnam**  
T +84-974270888  
sales.vt@hikvision.com

**Hikvision UAE**  
T +971-4-4432090  
salesme@hikvision.com

**Hikvision Singapore**  
T +65-6684-4718  
sg@hikvision.com

**Hikvision Spain**  
T +34-91-737-16-55  
info.es@hikvision.com

**Hikvision Tashkent**  
T +99-87-1238-9438  
uzb@hikvision.ru

**Hikvision Hong Kong**  
T +852-2151-1761  
info.hk@hikvision.com

**Hikvision Russia**  
T +7-495-669-67-99  
saleru@hikvision.com

**Hikvision Korea**  
T +82-(0)31-731-8817  
sales.korea@hikvision.com

**Hikvision Poland**  
T +48-22-460-01-50  
info.pl@hikvision.com

**Hikvision Indonesia**  
T +62-21-2933759  
Sales.Indonesia@hikvision.com

**Hikvision Colombia**  
sales.colombia@hikvision.com