

# GV-GEBF4911 Cloud AI 4MP H.265 4.3x Zoom Super Low Lux WDR Pro

## Full Color Warm LED IR Eyeball Dome IP Camera



- Direct-to-Cloud
- AI deep learning: AI Perimeter Protection & Classification (Human, Vehicle)
- 1/3" progressive scan CMOS sensor
- Triple streams from H.265, H.264 or MJPEG
- Min. illumination at 0.02 lux
- Up to 30 fps at 2592 x 1520
- Smart Warm LED distance up to 40 m (130 ft)
- Intelligent IR
- IR distance up to 40 m (130 ft)
- Wide Dynamic Range Pro (WDR Pro)
- Built-in microphone and speaker
- Built-in micro SD card slot (SD / SDHC / SDXC / UHS-I) for local storage
- 3-axis mechanism (pan / tilt / rotate)
- Ingress protection (IP66)
- Vandal resistance (IK10 for metal casing)
- DC 12V / PoE (IEEE 802.3af)
- Defog
- 3D noise reduction
- GV-Center V2 connection
- AI analytics (Line Crossing, Region Entrance, Region Exiting, Target Counting, Region Intrusion, Face Detection, Video Metadata)
- Active Deterrence: Alarm sound and LED lights triggered upon AI events
- Smart lighting switch between IR LED (for motion detection) and Warm LED (for people detection)
- Motion detection
- Text overlay
- Privacy mask
- 12 languages supported
- ONVIF (Profile G, S, T) conformant

### Introduction

GV-GEBF4911 is an outdoor eyeball dome IP camera equipped with smart warm LEDs for full color surveillance. The camera supports H.265 video codec to achieve better compression ratio while maintaining high quality pictures at reduced network bandwidths. GV-GEBF4911 adheres to IK10 and IP66 standards, and can be powered through PoE.

Empowered by deep learning algorithms, AI technology distinguishes human and vehicles from other moving objects. When integrated with GeoVision Video Management Software (VMS), it supports AI perimeter protection, real time alert, events playback and more. By connecting the camera to the cloud-based data center and video surveillance solution, GV-Cloud VMS, thousands of on-site videos, alarm devices, and AI events can be monitored and managed from a single platform.

## Deep Learning Function

### Face Detection



### AI Perimeter Protection

(Region Intrusion, Line Crossing, Region Entrance, Region Exiting)

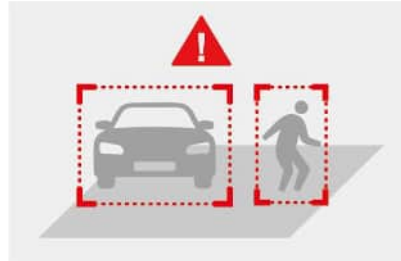

### People Counting



## Dimensions

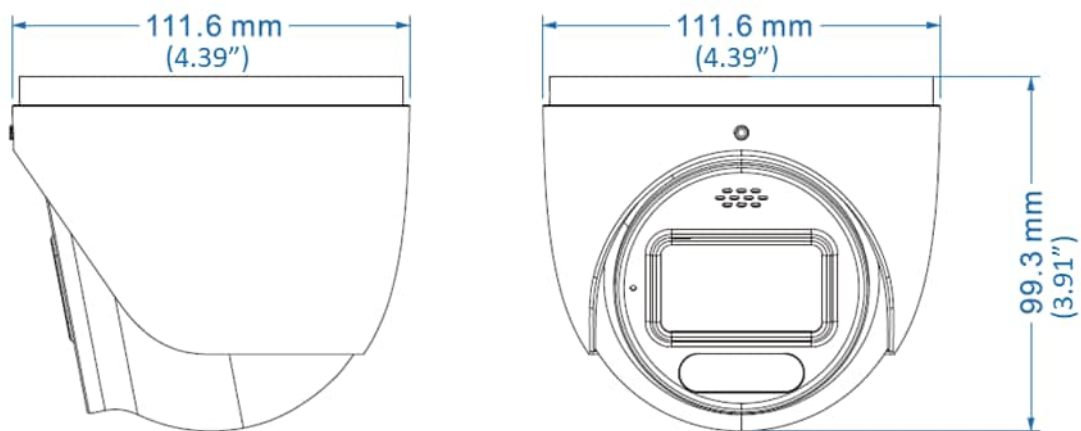

## Specifications

Camera		
Image Sensor	1/3" progressive scan CMOS	
Picture Elements	2592 (H) x 1520 (V)	
Minimum Illumination	Color	0.02 Lux (F1.4, AGC ON)
Shutter Speed	Automatic / Manual (1/3 ~ 1/100000 sec)	
White Balance	Automatic, Manual	
Gain Control	Automatic, Manual	
S/N Ratio	50 dB	
WDR	WDR Pro	
Dynamic Range	120 dB	
Lens		
Megapixel	4MP	
Day / Night	Yes (with removeable IR-cut filter)	
Lens Type	Motorized	
Focal Length	2.8 -12 mm	
Maximum Aperture	F/1.4	
Mount	Ø 14	
Horizontal FOV	96° - 32.33°	
Operation	Focus	Auto / Manual
	Zoom	4.3x
	Iris	Fixed
Active Deterrence LED	1 red and blue LED	

IR LED	Quantity	1 IR LED
	Max. IR Distance	40 m (130 ft)
Smart Illumination	LED Quantity	1 Warm LED
	Max. LED Distance	40 m (130 ft)
<b>Operation</b>		
Video Compression		H.265, H.265+, H.264, H.264+, MJPEG
Video Streaming		Triple streams from H.265, H.264 or MJPEG
Frame Rate	30 fps at 2592 x 1520, 30 fps at 2560 x 1440, 30 fps at 2304 x 1296, 30 fps at 1920 x 1080, 30 fps at 1280 x 720, 30 fps at 704 x 480, 30 fps at 640 x 480, 30 fps at 352 x 240, 30 fps at 480 x 240 (60 Hz)	
	25 fps at 2592 x 1520, 25 fps at 2560 x 1440, 25 fps at 2304 x 1296, 25 fps at 1920 x 1080, 25 fps at 1280 x 720, 25 fps at 704 x 567, 25 fps at 640 x 480, 25 fps at 352 x 288, 25 fps at 480 x 240 (50 Hz)	
*The frame rate and performance may vary depending on the number of connections and data bitrates (different scenes).		
Video Analytics		Motion Detection, Video Exception Detection (Scene Change, Video Blur and Abnormal Color Detection), Object Abandoned/Missing Detection, Heat Map
Image Setting		Brightness, Contrast, Saturation, Sharpness, Antiflicker, 3D Noise Reduction, Image Orientation (Flip, Mirror, 0°, 90°, 180°, 270°-including Corridor format)
Audio Compression		G.711
Audio Support		Two-way Audio
Digital I/O	Input	1 input, dry contact, NO/NC
	Output	1 relay output (1A 30V DC / 0.3A 125V AC)
<b>Video Resolution</b>		
Main Stream		2592 x 1520 (Default), 2560 x 1440, 2304 x 1296, 1920 x 1080, 1280 x 720
Sub Stream		1280 x 720 (Default), 704 x 480, 640 x 480, 352 x 240
Third Stream (Closed by Default)		704 x 480, 640 x 480, 352 x 240, 480 x 240
<b>Network</b>		
Interface		10/100 Ethernet
Protocol		UDP, IPv4, IPv6, DHCP, NTP, RTSP, RTP, RTCP, PPPoE, DDNS, SMTP, FTP, SNMP, RTMP, HTTP, 802.1x, UPnP, HTTPS, QoS, ONVIF (Profile G, S, T), API
<b>Deep Learning Function</b>		
AI Analytics		Line Crossing, Region Entrance, Region Exiting, Region Intrusion, Target Counting (Human & Vehicle classification), Face Detection, Video Metadata
<b>Mechanical</b>		
Camera Angle Adjustment	Pan	0° ~ 360°
	Tilt	0° ~ 75°
	Rotate	0° ~ 360°
Connectors	Power	DC 12V, PoE (IEEE 802.3af)
	Ethernet	RJ-45
	Audio	Two-way Audio (built-in speaker and microphone, or external speaker and microphone with power supply), 1 in / out (stereo phone jack, 3.5 mm / 0.14") *The Audio In port only supports microphones with power supply
	Digital I/O	4-pin terminal block pitch 3.5 mm (0.14")
Local Storage		Micro SD card slot (SD/SDHC/SDXC/UHS-I, Class 10) *UHS-II card type is not supported.
<b>General</b>		
Operation Temperature		-30~ 60°C (-22 ~ 140°F)
Humidity		0% ~ 95% (no condensation)
Power Source		DC 12V, PoE (IEEE802.3af)
Max. Power Consumption		12W
Dimensions		∅ 111.6 x 99.3 mm (∅ 4.39" x 3.91")
Weight		0.64 kg (1.41 lb)
Ingress Protection		IP66
Vandal Resistance		IK10 for metal casing

Certification	CE, FCC, RoHS compliant
<b>Web Interface</b>	
Installation Management	Web-based configuration
Maintenance	Firmware upgrade through Web Browser or Utility
Access from Web Browser	Live View, Playback, Video Recording, Image Quality, Bandwidth Control, Image Snapshot, Two-way Audio, Digital Zoom, Text Overlay, Image Masking, Intelligent Mark
Language	Czech, English, French, German, Hungarian, Italian, Japanese, Polish, Portuguese, Russian, Spanish, Traditional Chinese
<b>Software Applications</b>	
Software Supported	GV-VMS (V17.4.7 or later, V18.3.2 or later), GV-Edge Recording Manager (V2.2.5 or later), GV-Control Center (V4.1.1 or later), GV-Recording Server (V2.1.0 or later), GV-Cloud VMS, GV-Center V2 (V18.3.0A or later)
Smart Device Access	GV-Eye for iOS and Android (V3.0.2 or later)
Live Viewing	Web Browser (IE, Edge, Chrome, Firefox, Safari), Mobile App





**Note:**

1. When connecting to GV-Cloud VMS, avoid connecting to other GV-Software at the same time.
2. Specifications are subject to change without notice.

**Packing List**

- |                             |                          |
|-----------------------------|--------------------------|
| 1. GV-GEBF4911 Eyeball Dome | 4. Hex Key               |
| 2. Waterproof Rubber Set    | 5. Drill Template Paster |
| 3. Screw kit                | 6. Download Guide        |

**Accessories**

Model No.	Name		Details
GV-Mount506	Junction Box		Dimensions: 139.3 x 171.6 x 50 mm (5.48" x 2.81" x 1.97") Weight: 0.512 kg (1.13 lb)
GV-Mount211-4	Wall Mount Bracket		Dimensions: 129.8 x 154.9 x 74.4 mm (5.11" x 6.1" x 2.93") Weight: 0.527 kg (1.16 lb)
GV-Mount211-6 (must be used with Mount506)	Wall Mount Bracket		Dimensions: 199 x 139.3 x 140.9 mm (7.83" x 5.48" x 5.55") Weight: 0.56 kg (1.23 lb)
GV-PA191	Power over Ethernet (PoE) Adapter		The GV-PA191 is a Power over Ethernet (PoE) adapter designed to provide power to the IP device through a single Ethernet cable.
GV-PA301	Gigabit PoE Adapter		GV-PA301 is a Gigabit Power over Ethernet (PoE) adapter.

GV-POE Switch

The GV-POE Switch is designed to provide power along with network connection for IP devices. The GV-POE Switch is available in various models with different numbers and types of ports.

---

Power Adapter

Contact our sales representatives for the countries and areas supported.

---