

GV-EBDP5800 AI 180° Panoramic 5MP H.265 Super Low Lux WDR Pro IR Eyeball Dome IP Camera



- AI deep learning: AI Perimeter Protection & Classification (Human, Vehicle)
- 1/2.7" progressive scan CMOS
- Min. illumination at 0.01 lux
- Triple streams from H.265, H.264 or MJPEG
- Up to 30 fps at 2880 x 1620
- Intelligent IR
- IR distance up to 20 m (65 ft)
- Day and night function (with removable IR-cut filter)
- 180° panoramic view
- Ingress protection (IP67)
- Vandal resistance (IK10 for metal casing)
- DC 12V / PoE (IEEE 802.3af)
- Built-in micro SD card slot (SD / SDHC / SDXC / UHS-I, Class 10) for local storage
- Built-in Microphone
- Wide Dynamic Range Pro (WDR Pro)
- AI analytics (Intrusion, Crossing Line, Entering Area, Leaving Area)
- 3D noise reduction
- Motion detection / ultra motion detection
- Tampering Alarm
- Defog
- Text overlay
- Privacy mask
- 12 languages supported
- ONVIF (Profile G, S, T) conformant

Introduction

The panoramic eyeball IP camera is an outdoor, network camera that captures 180° horizontal coverage, providing a wide coverage of view for open and large areas with just one camera. It is equipped with an automatic IR-cut filter and IR LEDs for day and night surveillance. GV-EBDP5800 adheres to IK10 and IP67 standards, and can be powered through PoE. The camera supports H.265 video codec to achieve better compression ratio while maintaining high quality pictures at reduced network bandwidths.

Empowered by deep learning algorithms, AI technology distinguishes human and vehicles from other moving objects. Integrated with GeoVision Video Management Software (VMS), it supports AI perimeter protection, real time alert, event playback and more.

180 Degree Panoramic View



Deep Learning Function

AI Perimeter Protection

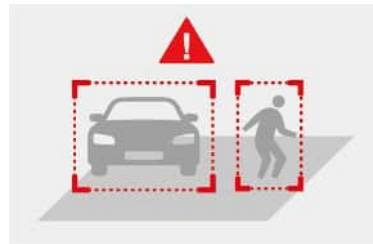

(Intrusion, Crossing Line Entering Area, Leaving Area)

Dimensions

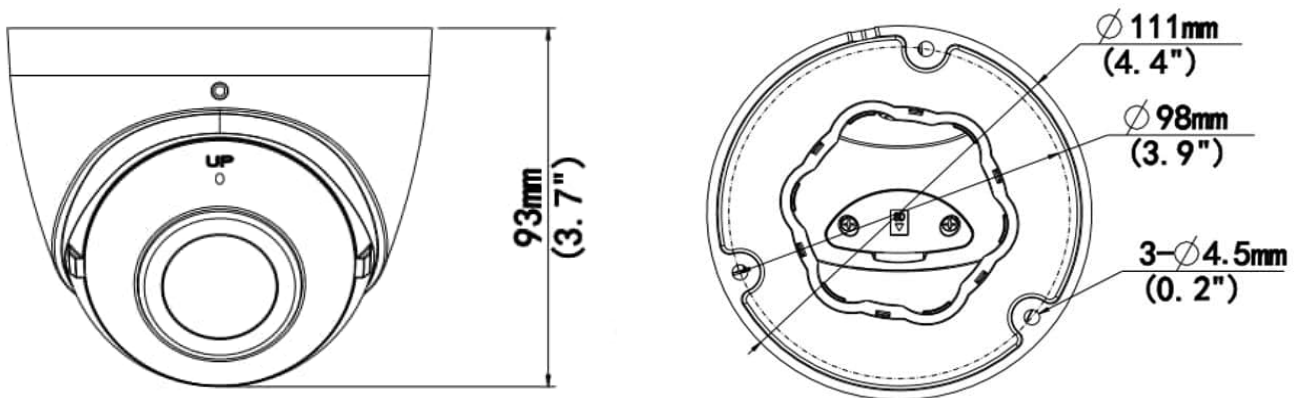

Specifications

Camera

Image Sensor	1/2.7" progressive scan CMOS	
Picture Elements	2880 (H) x 1620 (V)	
Minimum Illumination	Color	0.01 Lux (F2.0, AGC ON)
	IR On	0 Lux
Shutter Speed	Auto / Manual (1 ~ 1/100000 sec)	

White Balance	Auto / Manual				
Gain Control	Auto / Manual				
S/N Ratio	56 dB				
WDR Pro	Yes				
Dynamic Range	120 dB				
Lens					
Megapixel	5 MP				
Day/Night	Yes (with removable IR-cut filter)				
Focal Length	1.68 mm				
Lens Type	Fixed				
Maximum Aperture	F/2.0				
Mount	Ø12 mm				
Horizontal FOV	180°				
Operation	Focus	Fixed			
	Zoom	Fixed			
	Iris	Fixed			
IR LED Quantity	2 IR LEDs				
Max. IR Distance	20 m (65 ft)				
DORI	Detect	Observe	Recognize	Identify	
Lens	1.68 mm	37.8 m (124.0 ft)	15.1 m (49.6 ft)	7.6 m (24.8 ft)	3.8 m (12.4 ft)
Operation					
Video Compression	H.265, H.264, MJPEG				
Video Streaming	Triple streams				
Video Resolution	Main Stream	2880 x 1620 (Default), 2560 x 1440, 2304 x 1296, 1920 x 1080			
	Sub Stream	1920 x 1080, 1280 x 720, 720 x 576, 640 x 480, 640 x 360 (Default), 704 x 288, 352 x 288			
	Third Stream (Closed by Default)	720 x 576, 704 x 288, 640 x 360, 352 x 288			
Frame Rate	30 fps at 2880 x 1620, 2560 x 1440, 2304 x 1296, 1920 x 1080 (50/60 Hz) *The frame rate and performance may vary depending on the number of connections and data bitrates (different scenes).				
Video Analytics	Motion Detection / Ultra Motion Detection, Audio Alarm, Tamper Detection. *Tampering detection and audio alarm are only accessible through the camera's Web interface, which can be used to trigger alerts such as e-mail and FTP				
Image Setting	Brightness, Contrast, Saturation, Sharpness, Flicker-less, 3D Noise Reduction, Image Orientation (Flip, Mirror, 0°, 180°)				
Audio Compression	G.711				
Audio Support	One-way Audio				
Deep Learning Function					
AI Analytics	Human & Vehicle classification: Intrusion, Crossing Line, Entering Area, Leaving Area				
Network					
Interface	10/100 Ethernet				
Protocol	802.1x, ARP, DDNS, DHCP, DNS, FTP, HTTP, HTTPS, IGMP, IPv4, IPv6, NTP, ONVIF (Profile G, S, T), PPPoE, RTCP, RTP, RTSP, SMTP, SNMP, TCP, UDP				
Mechanical					
Camera Angle Adjustment	Pan	0° ~ 360°			
	Tilt	0° ~ 75°			
	Rotate	0° ~ 360°			
Connectors	Power	DC Jack, PoE			
	Ethernet	RJ-45			
	Audio	1 In (built-in microphone)			
	Local Storage	Micro SD card slot (SD / SDHC / SDXC / UHS-I, Class 10) * UHS-II card type is not supported.			
General					
Operating Temperature	-30°C ~ 60°C (-22°F ~ 140°F)				
Humidity	0 ~ 95% (no condensation)				
Power Source	1.25A 12V DC / PoE (IEEE802.3af)				

Max. Power Consumption	5.5 W
Dimensions	Ø 111 x 93 mm (Ø 4.4" x 3.7")
Weight	0.48 kg (1.06 lb)
Ingress Protection	IP67
Vandal Resistance	IK10 for metal casing
Certification	CE, FCC, LVD, RoHS, UL compliant
Web Interface	
Installation Management	Web-based configuration
Maintenance	Firmware upgrade through Web Browser or Utility
Access from Web Browser	Live View, Video Recording, Change Video Quality, Bandwidth Control, Image Snapshot, Text Overlay, Image Masking
Language	Czech, English, French, German, Hungarian, Italian, Japanese, Polish, Portuguese, Russian, Spanish, Traditional Chinese
Software Applications	
Software Supported	GV-VMS (V17.4.7 with patch / V18.3.2 with patch or later), GV-Control Center (V3.8.0 with patch / V4.2.0 or later), GV-Edge Recording Manager Windows Version (V2.2.7 or later), GV-Recording Server / Video Gateway (V2.1.0 or later)
Smart Device Access	GV-Eye for iOS / Android (V3.1.0 / V3.1.1 or later)
Live Viewing	Browser (IE, Edge, Chrome, Firefox, Safari)







Note: Specifications are subject to change without notice.

Packing List

- | | |
|--------------------------------|--------------------------|
| 1. GV-EBDP5800 IR Eyeball Dome | 4. Drill Template Paster |
| 2. Waterproof Rubber Set | 5. Torx Wrench |
| 3. Screw kit | 6. Download Guide |

Accessories

Model No.	Name		Details
GV-Mount107 (must be used with GV-Mount213)	Pendant Bracket		Dimensions: Ø 120 x 334 mm (Ø 4.72" x 13.15") Weight: 0.74 kg (1.63 lb)
GV-Mount211P	Wall Mount and Junction Box		Dimensions: Ø 233 x 126 x 126 mm (Ø 9.2" x 5" x 5") Weight: 1 kg (2.2 lb)
GV-Mount213	Wall / Ceiling Box Mount		Dimensions: Ø 109 x 39 mm (Ø 4.3" x 1.5") Weight: 0.2 kg (0.44 lb)
GV-Mount300-2	Convex Corner Mount		Dimensions: 137 x 233 x 160 mm (5.4" x 9.17" x 6.3") Weight: 1.65 kg (3.64 lb)

GV-Mount310-2	Concave Corner Mount		Dimensions: 111.2 x 369.9 x 210 mm (2.6" x 11.4" x 6.6") Weight: 1.65 kg (3.64 lb)
GV-Mount420 (must be used with GV-Mount211P)	Pole Mount Bracket		Dimensions: Ø 120 x 120 x 53.4 mm (Ø 4.7" x 4.7" x 2.1") Weight: 0.45 kg (0.99 lb) Steel Strap Diameter: Ø 67 ~ 127 mm (Ø 2.6" ~ 5")
GV-Mount924 (for standard US single and double gang boxes only)	Power Box Mount Bracket		Dimensions: Ø 128 x 18.5 mm (Ø 5" x 0.7") Weight: 0.15 kg (0.33 lb)
GV-Mount704 (must be used with GV-Mount107)	Extension Tube		Dimensions: Ø 3.5 x 10 or 20 or 30 or 50 cm (Ø 1.38 x 3.9 or 7.9 or 11.8 or 19.7") Weight: 225g or 360g or 500g or 780g (0.5 lb or 0.79 lb or 1.1 lb or 1.72 lb)
GV-PA191			GV-PA191 is a Power over Ethernet (PoE) adapter designed to provide power to the IP device through a single Ethernet cable.
GV-PA301			GV-PA301 is a Gigabit Power over Ethernet (PoE) adapter designed to provide power to the IP device through a single Ethernet cable.
GV-POE Switch	The GV-POE Switch is designed to provide power along with network connection for IP devices. The GV-POE Switch is available in various models with different numbers and types of ports.		
Power Adapter	Contact our sales representatives for the countries and areas supported.		