

DS-1M Series RJ45 Plug

Feature and Function

- 30u inch gold plated contacts
- Support 1000 Base-T Ethernet
- 8 pins × 8 conductors
- Compliant with RoHS 2.0

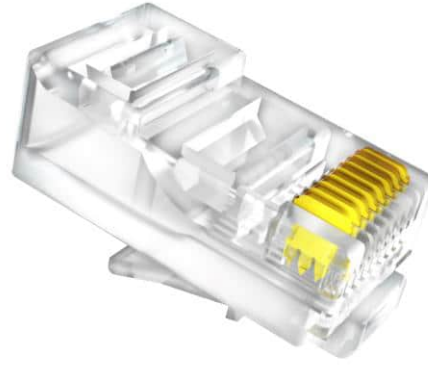

Specification

Item	DS-1M01	DS-1M5EUA-15U	DS-1M5EUA-30U	DS-1M02	DS-1M6UA-15U	DS-1M6UA-30U
Category	Cat 5E			Cat6		
Max Current	1.5A @25°C					
Max Voltage	≤150VAC					
Insulation Resistance	≥1000MΩ @100V DC					
Withstand Voltage	1KV AC RMS					
Contact Resistance	≤20 mΩ					
Retention Strength	50N for 60 ±5s					
Insert/Extraction Life	≥750 cycles					
Operating Temperature	-25~55°C					
Storage Temperature	-10 ~40 °C					
Relative Humidity	< 80%					
Plug Housing	Polycarbonate, UL94V-2					
Conductor	Copper alloy, 15u inch gold Plating	Copper alloy, 30u inch gold Plating	Copper alloy, 15u inch gold Plating	Copper alloy, 30u inch gold Plating	Copper alloy, 15u inch gold Plating	Copper alloy, 30u inch gold Plating

Mechanical(mm)

DS-1M01/ DS-1M5EUA-15U/DS-1M5EUA-30U

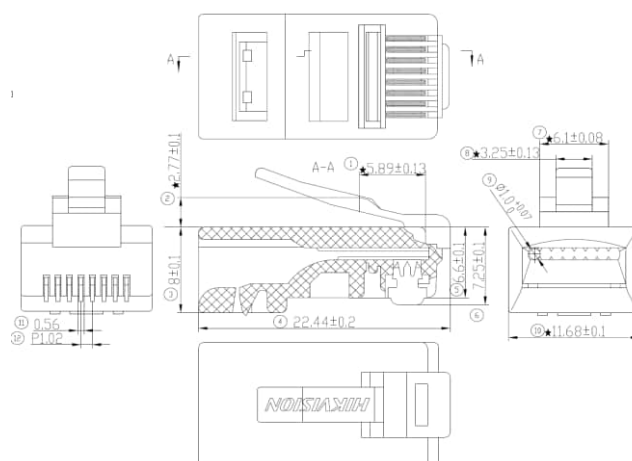

DS-1M02/DS-1M6UA-15U/DS-1M6UA-30U

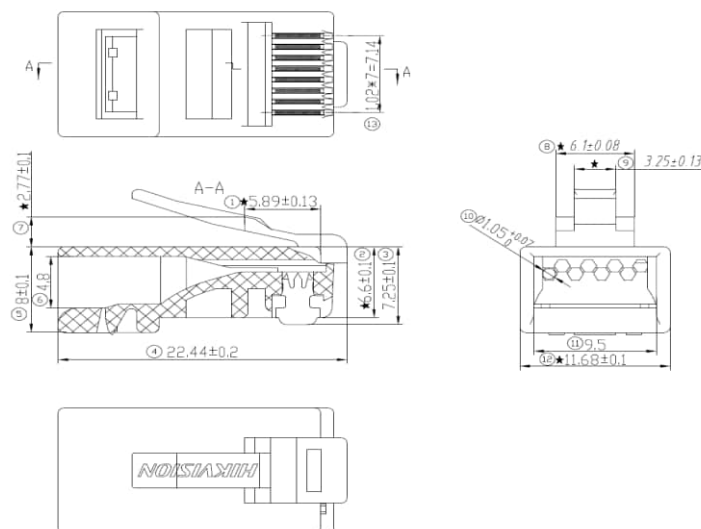

Available Model

DS-1M01

DS-1M5EUA-15U

DS-1M5EUA-30U

DS-1M02

DS-1M6UA-15U

DS-1M6UA-30U

Headquarters

No.555 Qianmo Road, Binjiang District,
Hangzhou 310051, China
T +86-571-8807-5998
www.hikvision.com



Follow us on social media to get the latest product and solution information.

