



AXIS C1710 Network Display Speaker

Wall-mounted 3-in-1 public address solution

This wall-mounted display speaker combines an attention-getting strobe, powerful speaker, and a display for text, ensuring clear paging, public address, and alerts. It also enables two-way audio, sirens, bells, and background music. Speaker, display, and strobe can be used alone or in combination. Display color, font, and text scrolling are configurable, as are the strobe color and pattern. Built on an open platform, this speaker supports integration with third-party mass notification systems and other solutions. A safety bracket makes installation with the included wall mount fast and easy, and a single cable provides power and connectivity.

- > [Combined speaker, display, strobe bar](#)
- > [Two-way audio](#)
- > [Remote health monitoring](#)
- > [Audio content prioritization and zoning](#)
- > [Freedom to integrate and to scale](#)



AXIS C1710 Network Display Speaker

Hardware

Enclosure

8 inch coaxial dynamic cone speaker in sealed enclosure

Max sound pressure level

110/103 dBSPL (PoE6/PoE4)

Frequency response

85 Hz - 20 kHz

Coverage pattern

Horizontal speaker coverage: 120°

Vertical speaker coverage: 120°

Audio input

Built-in microphone (can be disabled)

Input for external unbalanced microphone

Unbalanced line input

Built-in microphone specification

28 Hz -20 kHz

Amplifier description

Built-in 20 W Class D amplifier

Digital signal processing

Built-in and pre-configured

Connectors

3.5 mm audio input

RCA line-out

I/O: 4-pin 2.5 mm terminal block for 2x supervised configurable I/Os

USB 2.0 Type-A port (disabled, reserved for future use)

Display and indicators

Display size: 8.8 inch

Display type: LCD, full color

Display resolution: 1920 x 480

Display view angle: Full view

LED indicators: status-LED, two front-facing LEDs, dynamic LED strip with RGBW (red, green, blue, white)

LEDs and predefined light patterns

PIR sensor

Passive infrared (PIR) motion sensor

Max range: 10 m (33 ft)

Casing

Die-casted aluminum, plastic and steel

Color: White (NCS S 1002-B)

IP rating: 40

Dimensions

Height: 405 mm (15.9 in)

Width: 283 mm (11.1 in)

Depth: 107 mm (4.21)

Weight

6400 g (14.1 lbs)

Audio management

AXIS C1710 is to be used in combination with the appropriate Axis end-to-end audio management software solution or third-party integrations such as third-party mass notification systems.

AXIS Audio Manager Edge

Full functionality for the speaker. Limited functionality for strobe and display.

AXIS Audio Manager Pro

Full functionality for strobe, display and speaker.

AXIS Audio Manager Center

Full functionality for the speaker. Limited functionality for strobe and display.

For more details about audio management software, see axis.com/products/audio-management-software.

Audio software

Audio features

Full duplex echo cancellation

Audio streaming

Two-way (full duplex)

Audio encoding

AAC LC 8/16/32/48 kHz, G.711 PCM 8 kHz, G.726 ADPCM 8 kHz, Axis μ -law 16 kHz, WAV, MP3, Opus 8/16/48 kHz

MP3 in mono/stereo from 64 kbps to 320 kbps.

Constant and variable bit rate.

Sampling rate from 8 kHz up to 48 kHz.

Network

Network protocols

IPv4/IPv6¹, USGv6, ICMPv4/ICMPv6, HTTP, HTTPS², HTTP/2, TLS², QoS Layer 3 DiffServ, CIFS/SMB, SMTP, mDNS (Bonjour), UPnP®, SNMP v1/v2c/v3 (MIB-II), DNS/DNSv6, DDNS, NTP, NTS, RTSP, RTP, SRTP/RTSPS, TCP, UDP, IGMPv1/v2/v3, RTCP, DHCPv4/v6, ARP, SSH, LLDP, CDP, MQTT v3.1.1, Secure syslog (RFC 3164/5424, UDP/TCP/TLS), Link-Local address (ZeroConf)

System integration

Application Programming Interface

AXIS Camera Application Platform (ACAP)
Open API for software integration, including VAPIX®; specifications at axis.com/developer-community.
One-click cloud connection
Support for Session Initiation Protocol (SIP) for integration with Voice over IP (VoIP) systems, peer to peer or integrated with SIP/PBX.

Video management systems

Compatible with AXIS Camera Station Edge, AXIS Camera Station Pro, AXIS Camera Station 5, and video management software from Axis' partners available at axis.com/vms.

Edge-to-edge

Camera pairing

Mass notification

Singlewire InformaCast®, Intrado Revolution, Lynx Systems, Alertus

Unified communication

Verified compatibility:
SIP clients: 2N, Yealink, Cisco, Linphone, Grandstream
PBX/SIP servers: Cisco Call Manager, Cisco BroadWorks, Avaya, Asterix, Grandstream
Cloud service providers: Webex, Zoom

SIP

Supported SIP features: Secondary SIP server, IPv6, SRTP, SIPS, SIP TLS, DTMF (RFC2976 and RFC2833), NAT (ICE, STUN, TURN)
RFC 3261: INVITE, CANCEL, BYE, REGISTER, OPTIONS, INFO
DTMF (RFC 4733/RFC 2833)

Event conditions

Audio: audio detection, audio clip playing, speaker test result
Device status: IP address blocked/removed, live stream active, network lost, new IP address, PIR sensor, ring power overcurrent protection, system ready
Digital audio: digital signal contains Axis metadata, digital signal has invalid sample rate, digital signal missing, digital signal okay
Edge storage: recording ongoing, storage disruption, storage health issues detected
I/O: digital input is active, manual trigger, virtual input is active
MQTT: MQTT client connected
Scheduled and recurring: schedule

Event actions

Audio: run automatic speaker test
Audio clips: play, play while the rule is active, stop
Display: speaker display notification
I/O: toggle I/O once, toggle I/O while the rule is active
LEDs: flash status LED, flash status LED while the rule is active
Light and siren: run light profile, run light profile while the rule is active, stop activities
MQTT: send MQTT publish message
Notification: HTTP, HTTPS, TCP and email
Recordings: record audio, record audio while the rule is active
Security: erase configuration
SNMP trap messages: send, send while the rule is active

Built-in installation aids

Test tone verification and identification

Functional monitoring

Auto Speaker Test (verification via built-in microphone)

Approvals

EMC

CISPR 32 Class A, EN 55035, EN 55032 Class A, EN 61000-6-1, EN 61000-6-2, EN 61000-3-2, EN 61000-3-3

Australia/New Zealand: RCM AS/NZS CISPR 32 Class A

Canada: ICES(A)/NMB-3(A)

Japan: VCCI Class A

Korea: KS C 9832 Class A, KS C 9835

USA: FCC Part 15 Subpart B Class A

Safety

CAN/CSA C22.2 No. 62368-1, IEC/EN/UL 62368-1

1. Audio synchronization with IPv4 only.

2. This product includes software developed by the OpenSSL Project for use in the OpenSSL Toolkit. (openssl.org), and cryptographic software written by Eric Young (eay@cryptsoft.com).

Environment

IEC 60068-2-1, IEC 60068-2-2, IEC 60068-2-6,
IEC 60068-2-14, IEC 60068-2-27, IEC/EN 60529

Cybersecurity

FIPS 140

Cybersecurity

Edge security

Software: Signed OS, brute force delay protection, digest authentication and OAuth 2.0 RFC6749 OpenID Authorization Code Flow for centralized ADFS account management, password protection

Hardware: Axis Edge Vault cybersecurity platform
Secure keystore: secure element (CC EAL 6+, FIPS 140-3 Level 3), system-on-chip security (TEE)
Axis device ID, secure boot, encrypted filesystem (AES-XTS-Plain64 256bit)

Network security

IEEE 802.1X (EAP-TLS, PEAP-MSCHAPv2)³,
IEEE 802.1AE (MACsec PSK/EAP-TLS), IEEE 802.1AR,
HTTPS/HSTS³, TLS v1.2/v1.3³, Network Time Security
(NTS), X.509 Certificate PKI, host-based firewall

Documentation

AXIS OS Hardening Guide

Axis Vulnerability Management Policy

Axis Security Development Model

AXIS OS Software Bill of Material (SBOM)

To download documents, go to axis.com/support/cybersecurity/resources

To read more about Axis cybersecurity support, go to axis.com/cybersecurity

System on chip (SoC)

Model

NXP i.MX 8M Mini

Memory

1024 MB RAM, 1024 MB Flash

General

Power

Power over Ethernet (PoE) 802.3at Class 4 / 802.3bt Class 6

Storage

Support for microSD/microSDHC/microSDXC card
Support for SD card encryption (AES-XTS-Plain64 256bit)

Recording to network-attached storage (NAS)

For SD card and NAS recommendations see axis.com

Operating conditions

Temperature: 0 °C to 40 °C (32 °F to 104 °F)

Humidity: 10–85% RH (non-condensing)

Storage conditions

Temperature: -40 °C to 65 °C (-40 °F to 149 °F)

Humidity: 5–95% RH (non-condensing)

Box content

Network display speaker, 4-pin connector, wall bracket, installation guide, owner authentication key

Optional accessories

AXIS Surveillance Cards

AXIS C8310 Volume Controller

For more accessories, go to axis.com/products/axis-c1710#accessories

Languages

Web interface: English, German, French, Spanish, Italian, Russian, Simplified Chinese, Japanese, Korean, Portuguese, Polish, Traditional Chinese, Dutch, Czech, Swedish, Finnish, Turkish, Thai, Vietnamese

Warranty

5-year warranty, see axis.com/warranty

Part numbers

Available at axis.com/products/axis-c1710#part-numbers

Tools

Design

AXIS Site Designer

Available at axis.com

Installation

AXIS Device Manager, product selector, accessory selector

Available at axis.com

3. This product includes software developed by the OpenSSL Project for use in the OpenSSL Toolkit. (openssl.org), and cryptographic software written by Eric Young (eay@cryptsoft.com).

Sustainability

Substance control

PVC free, BFR/CFR free in accordance with JEDEC/ECA Standard JS709

RoHS in accordance with EU RoHS Directive 2011/65/EU and 2015/863, and standard EN IEC 63000:2018

REACH in accordance with (EC) No 1907/2006. For SCIP UUID, see echa.europa.eu

Materials

Renewable carbon-based plastic content: 70% (bio-based)

Screened for conflict minerals in accordance with OECD guidelines

To read more about sustainability at Axis, go to axis.com/about-axis/sustainability

Environmental responsibility

axis.com/environmental-responsibility

Axis Communications is a signatory of the UN Global Compact, read more at unglobalcompact.org

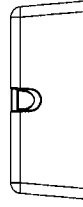
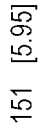
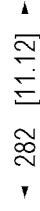
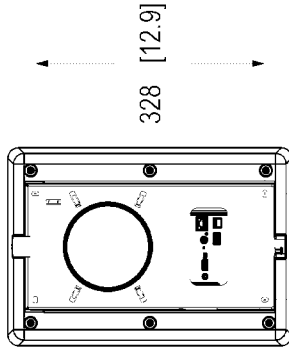
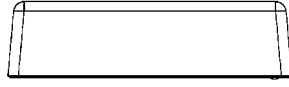
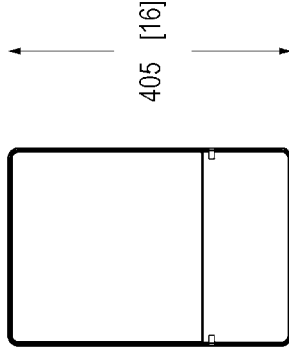
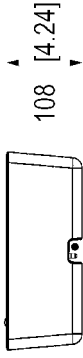
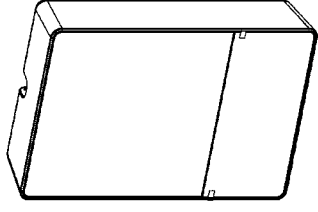

Dimensions in mm [inch]

Date:	Version:	Page:
2024 Dec-10	M1.1	16
Device name:	Size:	Sheet
3224739	A3	1(2)



AXIS C1710 Network Display Speaker

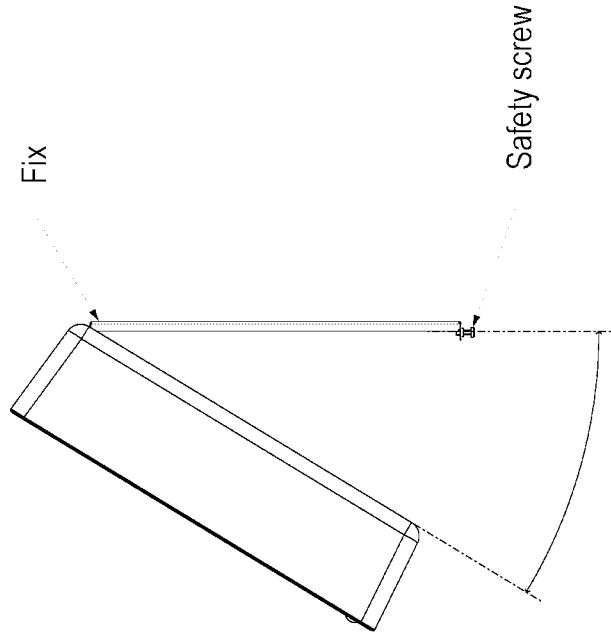

Rotation at installation.

Dimensions in mm [inch]

Date	Version	Scale
2024 Dec-18	M1.1	1:4
Issue number:	Rev:	Sheet
3224735	A3	2(2)

AXIS C1710 Network Display Speaker

