

NBT-8700-F03QF Bullet thermal QVGA 80° 30Hz

DINION thermal 8100i - QVGA



320 x 240



H.265



IVA

- ▶ Offers lens options from telephoto to wide-angle to suit diverse monitoring needs.
- ▶ Thermal imaging and IVA Pro Perimeter help achieve an ultra-low false alarm rate.
- ▶ QVGA thermal imaging.
- ▶ Rugged housing and cybersecure.
- ▶ AI-based (3D) autocalibration resulting in a fast and simple installation.

The DINION thermal 8100i camera is a bullet thermal camera built for mission-critical applications, prioritizing long-distance monitoring and reliable perimeter intrusion detection. By detecting heat emitted by objects and visualizing temperature differences, the camera operates without the need for visible light, making it highly effective in identifying potential threats across large perimeters. It combines thermal imaging with the Intelligent Video Analytics (IVA) Pro Perimeter feature, delivering high-accuracy detection of professional intruders while minimizing false alarms caused by environmental factors. The AI-driven autocalibration simplifies installation, ensuring quick and precise setup.

Designed with a rugged, corrosion-resistant housing, the DINION thermal 8100i camera offers robust reliability in any outdoor environment, enhancing durability and performance in even the most demanding conditions.

Functions

Thermal imager

The DINION thermal 8100i camera incorporates uncooled microbolometer / VOx (Vanadium Oxide) to deliver unparalleled thermal imaging. It detects heat signatures emitted by objects, making it effective in outdoor environments where visual light is absent or compromised, such as complete darkness, smoke, and fog. Its ability to visualize subtle temperature differences ensures exceptional situational awareness in even the most challenging conditions.

The key differentiator of the DINION thermal 8100i camera is its long-range detection capability, enabling reliable identification of people and vehicles at great distances, regardless of environmental distractions like headlights, shadows, or sudden lighting changes. This makes it an ideal solution for critical infrastructure security applications.

The DINION thermal 8100i camera offers a variety of intuitive user-adjustable settings, including contrast, brightness, sharpness, and noise reduction, enabling operators to customize the image for optimal clarity and performance. Additionally, a variety of user-selectable thermal color modes enhances image customization to meet specific operational needs.

Intelligent Video Analytics (IVA) Pro

The camera comes with IVA Pro Buildings and IVA Pro Perimeter pre-installed and brings highly reliable deep-learning based detection and tracking of persons and vehicles to scenes ranging from sterile zones to crowded and congested. Being extremely resistant to false triggers caused by challenging environments with rain, wind (moving trees), snow, and reflection as well as shadows and small animals, it reliably detects, tracks, and classifies objects. A smart set of alarm and counter rules allows to alert you when predefined alarms are triggered, and to forensically search with high efficiency through recordings. Configuration effort is minimized and made easy.

Range performance

Featuring a versatile lens portfolio ranging from telephoto to wide-angle, the DINION thermal 8100i camera easily adapts to a variety of monitoring needs. The detection performance is theoretical, based on the minimal resolution of objects required by Intelligent Video Analytics, and therefore covers only optimal conditions.

Maximum detection range with IVA Pro Perimeter

Lens horizontal field of view	Upright persons (1.8 m x 0.5 m (5.9 ft x 1.6 ft))	Crawling persons (0.5 m x 0.5 m (1.6 ft x 1.6 ft))	Frontal vehicle (1.5 m x 1.5 m (4.9 ft x 4.9 ft))
80°	32 m (105 ft)	19 m (62 ft)	58 m (190 ft)

For more information, including the DRI criteria (Detection / Recognition / Identification), commonly known as Johnson's Criteria, refer to the Video Analytic and Lens Calculator.

H.265 high-efficiency video encoding

The camera is designed on the most efficient and powerful H.264 and H.265/HEVC encoding platform. The camera is capable of delivering high-quality and high-resolution video with very low network load. With a doubling of encoding efficiency, H.265 is the compression standard of choice for IP video surveillance systems.

Resists rain, dust, and tampering with reliable operation across a wide temperature range

The robust design of the camera is rated according to IP66 / IP67 and IK10 standards, safeguarding the camera against rain and dust while also offering protection against vandalism and tampering. The camera can operate in a wide ambient temperature range between -40 °C (-40 °F) to +55 °C (131°F).

Data security

Special measures ensure the highest level of security for device access and data transport. On initial setup, the camera is only accessible over secure channels and enforces a password. Web browser and viewing client access can be protected using HTTPS or other secure protocols that support state-of-the-art TLS 1.2 with updated cipher suites including AES encryption with 256 bit keys. No software can be installed in the camera, and only authenticated firmware can be uploaded. A three-level password protection with security recommendations allows users to customize device access.

Network and device access can be protected using 802.1x network authentication with EAP/TLS. Superior protection from malicious attacks is guaranteed by the Embedded Login Firewall, on-board Trusted Platform Module (TPM) and Public Key Infrastructure (PKI) support.

The advanced certificate handling offers:

- Self-signed unique certificates automatically created when required

- Client and server certificates for authentication
- Client certificates for proof of authenticity
- Certificates with encrypted private keys
- 4096 key length

Advanced edge recording

Advanced edge recording provides the reliable storage solution possible due to the combination of the following functionalities:

- Dual microSD cards that can be set up as either:
 - Mirrored, for redundant storage
 - Failover, for extended service intervals
 - Extended, for maximum retention time
- Industrial microSD card support allows for extreme lifetime
- Health monitoring on industrial microSD card (slot 1) provides early service indication

Cloud-based services

Using the Bosch Security Cloud, you can configure, troubleshoot, and update supported devices using the browser-based interface or standard tools. With one click on Remote Portal, you can activate additional value-added services, such as Alarm Management in Cloud VMS, or VideoView+.

VideoView+ provides an easy-to-use and cost-effective solution to remotely connect to your device from anywhere, at any time. Leverage the power of the Bosch cloud to monitor your premises and get notified about any incident. VideoView+ also enables live streaming, locally and from remote, of up to 8 concurrent devices via Video Security Client, or of up to 4 concurrent devices on the Android and iOS app clients. This includes replay and export functionality, as well as forensic search to define and perform search criteria for recorded events.

Bosch Remote Portal

With the secure cloud infrastructure, Remote Portal, you can manage your connected Bosch devices. From the Remote Portal you can:

- Complete initial configuration of your connected Bosch devices (online or offline).
- Update firmware for single or multiple devices.
- Manage certificates.
- Monitor the health of your connected Bosch devices.

Project Assistant app

As the camera is equipped with a USB-C port for a Wireless installation dongle (sold separately: NCA-WLAN-EU, NCA-WLAN-NA), the installer can easily perform the initial configuration wirelessly. Using a mobile device with the Bosch Project Assistant app, you can do initial set-up to find the right scene. Simply connect the wireless installation dongle and go to the Bosch Project Assistant app, available for iOS, Windows, or Android.

Regulatory information

Type	Standard
Emission	EN 55032 (Class A) CISPR32 (Class A) ICES-003 (Class A) FCC Part 15 Subpart B Class A RSS-Gen, Issue 5 ICES-003 (Issue 7), Class A VCCI-CISPR 32 IEC 61000-6-4 EN IEC 61000-6-4
Immunity	EN 55035 CISPR35 IEC 61000-6-2 EN IEC 61000-6-2 EN 50130-4 EN 50121-4
Basic standards	EN 61000-4-2 EN 61000-4-3 EN 61000-4-4 EN 61000-4-5 EN 61000-4-6 EN 61000-4-8
Environmental	DIN EN 62321:2012-10
Reliability	EN 60068-2-1 EN 60068-2-2 EN 60068-2-6 EN 60068-2-18 EN 60068-2-27 EN 60068-2-30 EN 60068-2-42 EN 60068-2-52 EN 60068-2-75 EN 60068-2-78
Corrosion resistance	ISO 14993
Safety	AS/NZS 62368.1 CSA C22.2 No. 62368-1 EN IEC 62368-1 IEC 62368-1 J62368-1 SASO-IEC 62368-1 UL 62368-1

Type	Standard
Impact protection	EN 62262 (IK10)
Ingress protection	EN 60529 (IP66/67) UL50E Type 4X
Shock / vibration protection	NEMA TS2 (section 2.2.8 - section 2.2.9)
Marks	CE, FCC, UL, RCM, Cmm, BIS, VCCI, China RoHS
Compliance	NDAA compliant, TAA compliant

Region	Regulatory compliance/quality marks	
Global	IEC 62443-4-1	Industrial Cyber Security Capability
Europe	CE	
USA	UL CAP	Cybersecurity Assurance Program

Installation/configuration notes

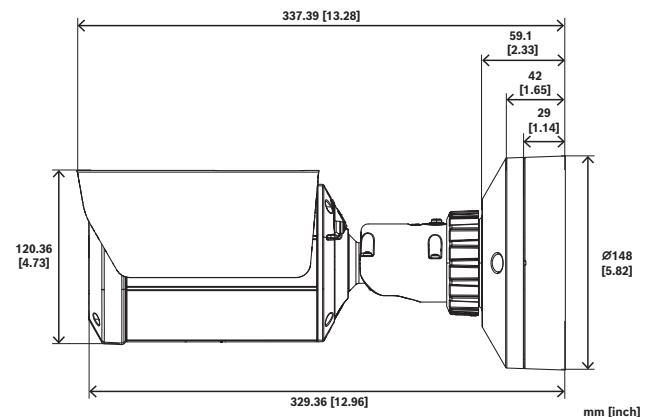

Dimensions in mm (inch)

Parts included

Quantity	Component
1	DINION thermal 8100i camera
1	TR20 key
1	Mini screwdriver
1	Grommet (IP66)
1	Grommet (IP67)
1	Quick installation guide
1	Safety and security information

Quantity	Component
3	Installer UX labels

Technical specifications

Thermal sensor

Sensor type	Uncooled microbolometer / VOx (vanadium oxide)
Spectral response (µm)	8 µm – 14 µm
Effective pixels (H x V)	320 x 240
Pixel pitch (µm)	12 µm
Frequency (Hz)	30 Hz

Thermal sensitivity

Sensitivity (NETD)	< 30 mK at 25 °C
--------------------	------------------

Thermal lens

Lens focal length (mm)	3 mm
Lens aperture (/F)	0.8 /F
Focus	Fixed focus, athermalized
Minimum focus distance (m)	0.5 m
Horizontal field of view (°)	80°
Vertical field of view (°)	58°

Platform

Common Product Platform	CPP14
Memory (MB)	2048MB RAM; 8192MB Flash

Video streaming

Resolution	320 x 240
Video compression	H.264 (ISO/IEC 14496-10); M-JPEG; H.265/HEVC
Frame rate (fps)	1 fps – 30 fps
GOP structure	IP; IBP; IBBP
Streaming	4 configurable streams in H.265; H.264 and M-JPEG; Configurable framerate and bandwidth

Video functions

Camera functionality	Brightness; Contrast; Sharpness; Histogram equalization; Contrast region; Noise filter; Image rotation
Number of privacy masks	8
Thermal color mapping	12 selectable modes

Video content analysis

Analysis type	MOTION+; Intelligent Video Analytics Pro: IVA Pro Buildings; Intelligent Video Analytics Pro: IVA Pro Perimeter
Alarm triggers	Any object; Object in field; Line crossing; Enter / leave field; Loitering; Follow route; Idle / removed object; Occupancy; Objects stopping or starting to move
Object filters	Size; Aspect ratio; Speed; Direction; Object classes (4)
Object classes	Person; Bike; Car; Truck
Calibration	Map-based; Measurement-based; Autocalibration
Additional functionalities	Tamper detection

Storage

Internal storage	5-s-pre-alarm-recording
Memory card slot	2 slots: Micro SDHC; Micro SDXC, up to 2 TB
Industrial SD cards	Extreme lifetime and health monitoring support that provides early service indication
Dual SD-card slot configurations	Mirror (redundant storage); Failover (extended service interval); Extend (maximum retention time); Automatic Network Replenishment

Inputs and outputs

Ethernet	RJ45; Punch down connector
Audio line in	10 kOhm typical; maximum 1 Vrms
Audio line out	1.5 kOhm typical; 1 Vrms
Alarm inputs	2; Dry contact; 5 - 40 VDC; 2.2 K end-of-line resistor

Alarm outputs	1; maximum 30 VAC; +40 VDC; 0.5 A; continuous 10 VA
Power output	+ 12VDC 50mA (switchable)
USB	USB 2.0 Type C, for use with Wireless installation dongle for setup and commissioning (sold separately)
Fiber optics	Fiber Optic Ethernet Media Converter kit (VG4-SFPCKT) (sold separately)

Audio

Audio input	Line-in; Mic-level input, switchable
Audio output	Line-out
Compression and sampling rate	AAC-LC 48kbps 16 kHz
Minimum signal-to-noise ratio (dB)	50 dB
Audio streaming	Full duplex; Half duplex

Network

Protocols / standards	IPv4; IPv6; UDP; TCP; HTTP; HTTPS; RTP/RTCP; IGMP V2/V3; ICMP; ICMPv6; RTSP; FTP; ARP; DHCP; APIPA (Auto-IP, link local address); NTP (SNTP); SNMP (V1, MIBII); SNMP (V3, MIBII); 802.1x, EAP/TLS; DNS; DNSv6; DDNS (DynDNS.org, selfHOST.de, no-ip.com); SMTP; iSCSI; DiffServ (QoS); LLDP; SOAP; CHAP; Digest authentication
Ethernet type	10/100BASE-T
Conformity	ONVIF Profile S; ONVIF Profile G; ONVIF Profile T; ONVIF Profile M

Data security

Crypto coprocessor (TPM)	RSA 4096 bit; AES/CBC 256 bit
PKI	X.509 certificates; SCEP
Encryption	TLS 1.2; AES 256; AES 128; TLS 1.3
Local storage encryption	XTS-AES
Video authentication	MD5; SHA-1; SHA-256; Checksum
Firmware protection	Signed firmware; Secure boot

Electrical

PoE input	PoE IEEE 802.3af / 802.3at Type 1, Class 3; PoE and auxiliary power can be connected simultaneously for redundant operation
Input voltage (VAC)	24 VAC ±10%
Input voltage (VDC)	12 VDC – 26 VDC ±10%
Power consumption PoE (W) (typical – maximum)	12.9 W
Power consumption VAC (VA) (typical – maximum)	31 VA
Power consumption VDC (W) (typical – maximum)	16 W

Mechanical

Dimensions (Ø x D) (mm)	148 mm x 352 mm
Dimensions (Ø x D) (in)	5.82 in x 13.85 in
Weight (kg)	2.95 kg
Weight (lb)	6.50 lb
Material	Housing: Aluminum with dehumidifying membrane and waterproof connection area
Color (RAL)	RAL 9003 Signal white
Mounting type	Surface-mounted

Environmental

Operating temperature (°C)	-40 °C – 55 °C, up to 74 °C according to NEMA TS2 (section 2.2.7)
Operating temperature (°F)	-40 °F – 131 °F, up to 165 °F according to NEMA TS2 (section 2.2.7)
Storage temperature (°C)	-40 °C – 70 °C
Storage temperature (°F)	-40 °F – 158 °F
Operating relative humidity, non-condensing (%)	5% – 95%
Operating relative humidity, condensing (%)	5% – 100%
IP rating	IP66; IP67
Impact protection	IK10
Degree of protection	UL50 Type 4X

Interior heater

Auto

Ordering information**NBT-8700-F03QF Bullet thermal QVGA 80° 30Hz**

Fixed bullet thermal camera, QVGA, IVA Pro Perimeter, IP67, IK10, H265, 3 mm lens, 80°

NDAA and TAA compliant.

Order number **NBT-8700-F03QF**

Accessories**NDA-U-PMAL Pole mount adapter large**

Universal pole mount adapter, white; large

Order number **NDA-U-PMAL**

NDA-U-CMT Corner mount adapter

Universal corner mount, white

Order number **NDA-U-CMT**

NDA-U-CBB Conduit back box, 148mm

Outdoor conduit back box, 148mm

Order number **NDA-U-CBB**

NBA-7070-PA0 Direct-mount surveillance cabinet 24VAC

Direct-mount surveillance cabinet, 24 VAC

Order number **NBA-7070-PA0**

NBA-7070-PA1 Direct-mount surveillance cabinet 120VAC

Direct-mount surveillance cabinet, 120 VAC

Order number **NBA-7070-PA1**

NBA-7070-PA2 Direct-mount surveillance cabinet 230VAC

Direct-mount surveillance cabinet, 230 VAC

Order number **NBA-7070-PA2**

VG4-SFP SCKT Ethernet to SFP interface kit

Ethernet media converter video transmitter/data receiver fiber optic kit

Order number **VG4-SFP SCKT**

NCA-WLAN-EU Wireless installation dongle EU

Wireless installation dongle for wireless commissioning

Order number **NCA-WLAN-EU**

NCA-WLAN-NA Wireless installation dongle NA

Wireless installation dongle for wireless commissioning for North America

Order number **NCA-WLAN-NA**



<https://www.boschsecurity.com>