

DS-2DE7A232IWG-EB/SL**2 MP 32X Powered by DarkFighter IR Acusense Warning Enhanced Network Speed Dome**

Hikvision DS-2DE7A232IWG-EB/SL 2 MP 32× IR Network Speed Dome adopts 1/2.8" progressive scan CMOS chip. With the 25× optical zoom lens, the camera offers more details over expansive areas.

This series of cameras can be widely used for wide ranges of high-definition, such as the rivers, roads, railways, airports, squares, parks, scenic spots, and venues, etc.

Empowered by deep learning algorithms, Hikvision AcuSense technology brings human and vehicle targets classification alarms to front- and back-end devices. The system focuses on human and vehicle targets, vastly improving alarm efficiency and effectiveness.

- 1/2.8" progressive scan CMOS
- High quality imaging with 2 MP resolution, up to 60 fps
- Excellent low-light performance with powered-by-DarkFighter technology
- 25× optical zoom and 16× digital zoom provide close up views over expansive areas
- Focuses on human and vehicle targets classification based on deep learning
- Powerful sound and strobe light deterrent, effective up to 100 meters
- Expansive night view with up to 200 m IR distance

▪ Specification

Camera	
Image Sensor	1/2.8" progressive scan CMOS
Max. Resolution	1920 × 1080
Min. Illumination	Color: 0.005 Lux @ (F1.6, AGC ON), B/W: 0.001 Lux@(F1.6, AGC ON), 0 Lux with IR
Shutter Speed	1/1 s to 1/30000 s
Day & Night	IR cut filter
Zoom	32 × optical, 16 × digital
Slow Shutter	Yes
Lens	
Focal Length	4.8 to 153 mm
FOV	Horizontal field of view: 55° to 1.7°, vertical field of view: 33° to 1.0°, diagonal field of view: 62.4° to 1.9°
Focus	Auto, semi-auto, manual
Aperture	Max. F1.6
Zoom Speed	Approx. 4.8 s
Illuminator	
Supplement Light Type	IR
Supplement Light Range	IR distance: up to 200 m
Smart Supplement Light	Yes
IR Wavelength	850 nm
Strobe Light Flashing	Up to 100 m white light flashing
PTZ	
Movement Range (Pan)	360°
Movement Range (Tilt)	-15° to 90° (auto flip)
Pan Speed	Pan speed: configurable from 0.1° to 160°/s; preset speed: 240°/s
Tilt Speed	Tilt speed: configurable from 0.1° to 120°/s, preset speed 200°/s
Proportional Pan	Yes
Presets	300
Preset Freezing	Yes
Patrol Scan	8 patrols, up to 32 presets for each patrol
Pattern Scan	4 pattern scans
Park Action	Preset, patrol scan, pattern scan, auto scan, tilt scan, random scan, frame scan, panorama scan
3D Positioning	Yes
PTZ Status Display	Yes
Scheduled Task	Preset, pattern scan, patrol scan, auto scan, tilt scan, random scan, frame scan, panorama scan, dome reboot, dome adjust, aux output
Power-off Memory	Yes
Video	
Sub-Stream	50 Hz: 25 fps (704 × 576, 640 × 480, 352 × 288); 60 Hz: 30 fps (704 × 480, 640 × 480, 352 × 240)
Main Stream	50 Hz: 50 fps (1920 × 1080, 1280 × 960, 1280 × 720) 60 Hz: 60 fps (1920 × 1080, 1280 × 960, 1280 × 720) *High frame rate is supported under certain settings.

Third Stream	50 Hz: 25 fps (1920 × 1080, 1280 × 960, 1280 × 720, 704 × 576, 640 × 480, 352 × 288); 60 Hz: 30 fps (1920 × 1080, 1280 × 960, 1280 × 720, 704 × 480, 640 × 480, 352 × 240)
Video Compression	Main stream: H.265+/H.265/H.264+/H.264 Sub-stream: H.265/H.264/MJPEG Third stream: H.265/H.264/MJPEG
Video Bit Rate	32 kbps to 16384 kbps
H.264 Type	Baseline Profile/Main Profile/High Profile
H.265 Type	Main Profile
Scalable Video Coding (SVC)	H.264 and H.265 encoding
Region of Interest (ROI)	8 fixed regions for each stream
Audio	
Audio Compression	G.711,G.722.1,G.726,MP2L2,PCM,MP3,AAC-LC
Audio Bit Rate	64 Kbps (G.711),16 Kbps (G.722.1),16 Kbps (G.726),32 to 192 Kbps (MP2L2),16 to 64Kbps (AAC-LC),8 to 320 Kbps (MP3)
Audio Sampling Rate	MP2L2: 16kHz,AAC-LC: 16kHz,PCM: 8kHz, 16kHz,MP3: 8kHz, 16kHz
Environment Noise Filtering	Yes
Audible Warning	Up to 100 m
Network	
Protocols	TCP/IP,ICMP,HTTP,FTP,DHCP,DNS,DDNS,RTP,RTSP,RTCP,NTP,UPnP,SMTP,SNMP,IGMP, QoS,IPv4/IPv6,UDP,Bonjour,SSL/TLS,WebSocket,WebSockets
Simultaneous Live View	Up to 20 channels
API	ONVIF (ProfileS, ProfileG, ProfileT),ISAPI,SDK,ISUP
User/Host	Up to 32 users, 3 user levels: administrator, operator, and user
Security	Password protection, complicated password, HTTPS encryption, 802.1X authentication (EAP-TLS, EAP-LEAP, EAP-MD5), watermark, IP address filter, basic and digest authentication for HTTP/HTTPS, RTP/RTSP over HTTPS, control timeout settings, security audit log, TLS 1.2, TLS 1.3, host authentication (MAC address)
Network Storage	NAS (NFS, SMB/CIFS), auto network replenishment (ANR)
Client	iVMS-4200, HikCentral Pro, Hik-Connect
Web Browser	IE11, Chrome 80+, Firefox 80+, Safari 13+, Edge 89+
Image	
Image Settings	Saturation, brightness, contrast, sharpness, gain, and white balance adjustable by client software or web browser
Day/Night Switch	Day, Night, Auto, Schedule
Wide Dynamic Range (WDR)	120 dB
SNR	> 52 dB
Defog	Digital defog
Image Stabilization	EIS
Image Enhancement	BLC, HLC, 3D DNR
Privacy Mask	24 programmable polygon privacy masks, mask color or mosaic configurable
Regional Focus	Yes
Regional Exposure	Yes
Interface	
Ethernet Interface	1 RJ45 10M/100M self-adaptive Ethernet port
On-board Storage	Built-in memory card slot, support microSD/microSDHC/microSDXC card, up to 512 GB

Audio	1 input (line in), max. input amplitude: 2-2.4 vpp, input impedance: 1 kΩ ± 10%; 1 output (line out), line level, output impedance: 600 Ω
Alarm	2 inputs, 1 output
Reset	Yes
Built-in Speaker	2 built-in speakers, with effective distance reaching max. 100 meters
Event	
Basic Event	Motion detection, video tampering alarm, exception, alarm input and output
Smart Event	Line crossing detection, intrusion detection, region entrance detection, region exiting detection
Linkage	Upload to FTP/NAS/memory card, notify surveillance center, send email, trigger alarm output, trigger recording, white light flashing, smart tracking, and PTZ actions (such as preset, patrol scan, pattern scan)
Deep Learning Function	
Face Capture	Detects up to 5 faces simultaneously. Supports detecting, capturing, grading, selecting of face in motion, and output the best face picture of the face
Linkage and Tracking	
Smart Tracking	Manual tracking, auto-tracking
General	
Power	36 VDC ± 25%, max. 42 W, Hi-PoE
Dimension	∅ 220 mm × 363.3 mm (∅ 8.66" × 13.91")
Weight	Approx. 5 kg (11.03 lb.)
Material	ADC12
Operating Condition	-30 °C to 65 °C (-22 °F to 149 °F). Humidity 90% or less (non-condensing)
Demist	Yes
Approval	
EMC	CE-EMC (EN 55032:2015, EN 61000-3-2:2019, EN 61000-3-3:2013 + A1:2019, EN 50130-4:2011 + A1:2014), RCM (AS/NZS CISPR 32:2015), IC (ICES-003: Issue 7)
Safety	CB (IEC 62368-1:2014 + A11), CE-LVD (EN 62368-1:2014/A11:2017), LOA (IEC/EN 60950-1)
Environment	CE-RoHS (2011/65/EU); WEEE (2012/19/EU); Reach (Regulation (EC) No 1907/2006)
Protection	IP67 (IEC 60529:2013), IK10 (IEC 62262:2002), TVS 6000 V lightning protection, surge protection and voltage transient protection

▪ DORI

The DORI (detect, observe, recognize, identify) distance gives the general idea of the camera ability to distinguish persons or objects within its field of view. It is calculated based on the camera sensor specification and the criteria given by EN 62676-4:2015.

DORI	Detect	Observe	Recognize	Identify
Definition	25 px/m	63 px/m	125 px/m	250 px/m
Distance (Tele)	1600.0 m (5249.3 ft)	634.9 m (2083.1 ft)	320.0 m (1049.9 ft)	160.0 m (524.9 ft)

▪ Available Model

DS-2DE7A232IWG-EB/SL

▪ Dimension

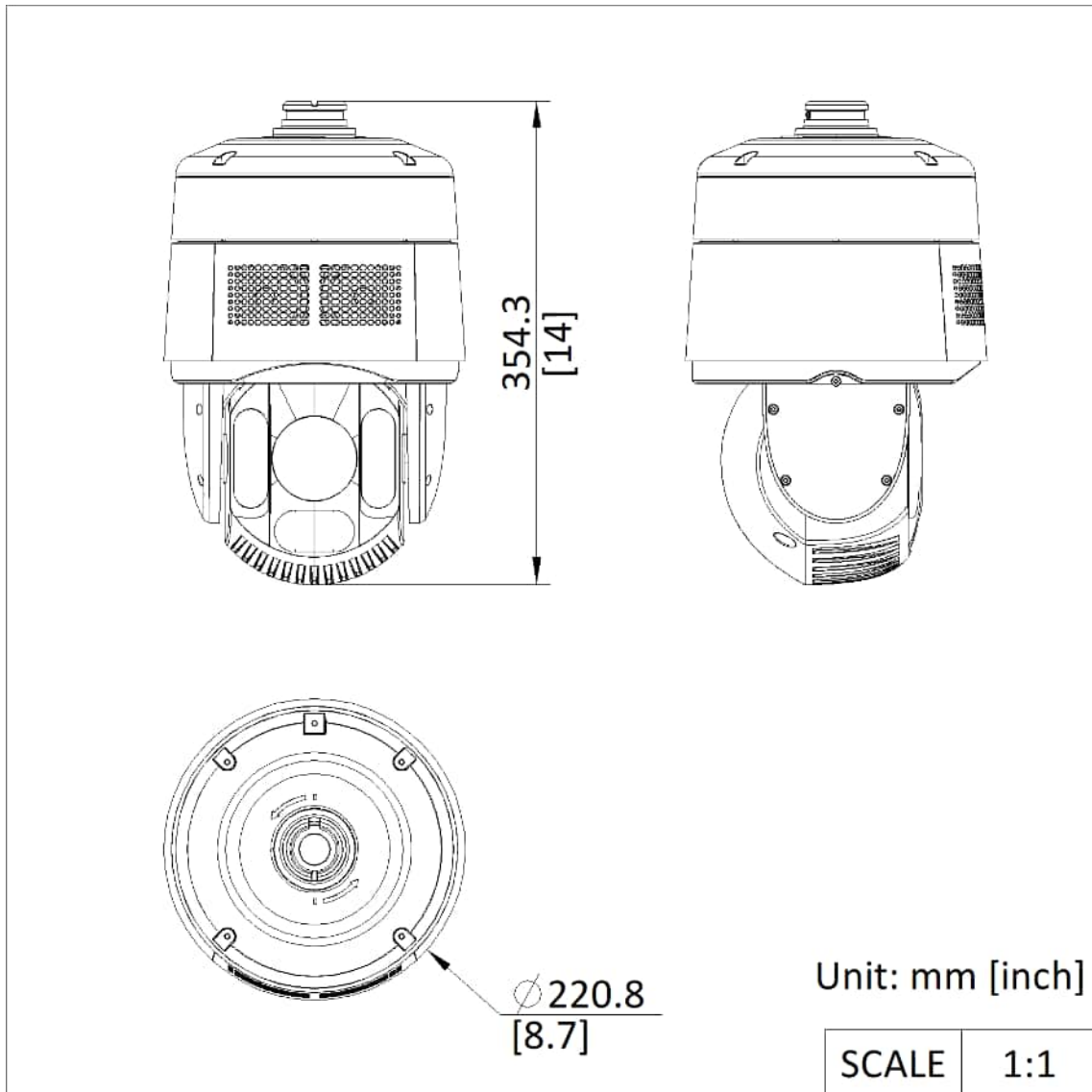















▪ Accessory

▪ Included





▪ Optional

DS-1602ZJ-R/B	DS-1663ZJ	DS-1604ZJ-BOX-PO LE	DS-1604ZJ-BOX-CO RNER	DS-1604ZJ-box
---------------	-----------	------------------------	--------------------------	---------------

				
DS-1684ZJ	DS-1661ZJ-R/B	DS-1619ZJ	DS-1662ZJ	DS-1661ZJ
				
DS-1604ZJ-pole	DS-1673ZJ	DS-1673ZJ	DS-1673ZJ	
				

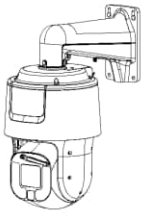
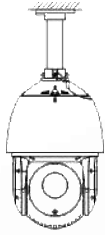
▪ **Installation Methods**

Wall Mounting DS-1602ZJ	Wall Mounting DS-1602ZJ-R/B	Wall Mounting DS-1604ZJ-box	Pendant Mounting DS-1663ZJ	Pendant Mounting DS-1661ZJ-R/B
				
Pendant Mounting DS-1662ZJ	Pendant Mounting DS-1661ZJ	Vertical Pole Mounting DS-1604ZJ-BOX-POLE	Vertical Pole Mounting DS-1684ZJ+DS-1602ZJ	Vertical Pole Mounting DS-1604ZJ-pole
				
Corner Mounting DS-1604ZJ-BOX-CORN ER	Gooseneck Mounting DS-1619ZJ	Horizontal Pole Mounting DS-1673ZJ+DS-1662ZJ	Horizontal Pole Mounting DS-1673ZJ+DS-1661ZJ	Horizontal Pole Mounting DS-1673ZJ+DS-1663ZJ



See Far, Go Further



www.hikvision.com
support@hikvision.com

