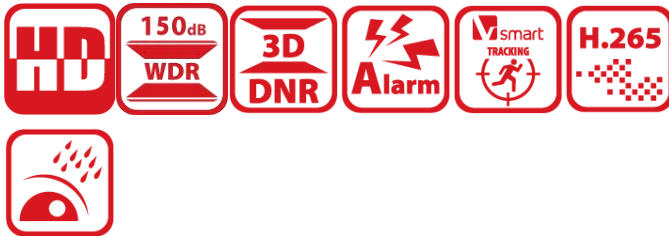

DS-2DF6C445IWG1-EL(W)**DF6C Series 4MP 45X Powered by DarkFighter IR Network Speed Dome****DarkFighter 2.0**

Hikvision 4 MP 45× Network IR Speed Dome adopts 1/2.8" progressive scan CMOS chip. With the 45 × optical zoom lens, the camera offers more details over expansive areas.

This series of cameras can be widely used for wide ranges of high-definition, such as the rivers, forests, roads, railways, airports, ports, squares, parks, scenic spots, stations and large venues, etc.

Hikvision has been dedicated to develop products with security since established.

Hikvision always follows security by design principle and has adopted many methods of security technologies into our product development lifecycle, including terminal security, data security, application security, network security, and privacy protection. In the meantime, the security technologies used by Hikvision are all in compliance with local applicable laws and safety regulations. These security measures could enhance product's cyber security protection capability and protect your devices as well as your data from malicious cyber attacks.

- 1/2.8" progressive scan CMOS
- High quality imaging with 4 MP resolution
- Excellent low-light performance with powered-by-DarkFighter 2.0 technology
- Clear imaging against strong back light due to 120 dB AWDR technology
- 45 × optical zoom and 16 × digital zoom provide close up views over expansive areas
- Expansive night view with up to 250 m IR distance
- Water and dust resistant (IP67) and vandal proof (IK10) excluding glass window
- Supports face capture to detect, capture, grade, and select faces in motion

▪ Specification

Camera	
Image Sensor	1/2.8" Progressive Scan CMOS
Min. Illumination	[Panoramic channel] Color: 0.005 Lux @ (F1.6, AGC ON), B/W: 0.001 Lux @ (F1.6, AGC ON)
Shutter Speed	1/1 s to 1/30,000 s
Slow Shutter	Yes
Day & Night	IR cut filter
Zoom	[PTZ channel] 45 × optical, 16 × digital
Max. Resolution	2688 × 1520
Lens	
Focus	Auto, semi-auto, manual, rapid focus
Focal Length	4 to 180 mm
Zoom Speed	Approx. 3.7 s
FOV	Horizontal field of view: 61.3° to 1.7°, vertical field of view: 36.4° to 1.05°, diagonal field of view: 68.5° to 1.93°
Aperture	Max. F1.6
Illuminator	
Supplement Light Type	IR
Supplement Light Range	IR distance: up to 250 m
Smart Supplement Light	Yes
PTZ	
Movement Range (Pan)	360°
Movement Range (Tilt)	-20° to 90°, auto flip
Pan Speed	Pan speed: configurable from 0.1° to 300°/s, preset speed: 400°/s
Tilt Speed	Tilt speed: configurable from 0.1° to 200°/s, preset speed 300°/s
Proportional Pan	Yes
Presets	300
Patrol Scan	8 patrols, up to 32 presets for each patrol
Pattern Scan	4 pattern scans, record time over 10 minutes for each scan
Power-off Memory	Yes
Park Action	Preset, pattern scan, patrol scan, auto scan, tilt scan, random scan, frame scan, panorama scan
3D Positioning	Yes
PTZ Status Display	Yes
Preset Freezing	Yes
Scheduled Task	Preset, pattern scan, patrol scan, auto scan, tilt scan, random scan, frame scan, panorama scan, dome reboot, dome adjust, aux output
Video	
Main Stream	50 Hz : 50fps (2688 × 1520 , 2560 × 1440 , 1920 × 1080 , 1280 × 960 , 1280 × 720)
	60 Hz : 60fps (2688 × 1520 , 2560 × 1440 , 1920 × 1080 , 1280 × 960 , 1280 × 720)
Sub-Stream	50 Hz : 25 fps (704 × 576 , 640 × 480 , 352 × 288)
	60 Hz : 30 fps (704 × 480 , 640 × 480 , 352 × 240)

Video Compression	Main stream: H.265+/H.265/H.264+/H.264 Sub-stream: H.265/H.264/MJPEG Third stream: H.265/H.264/MJPEG
Third Stream	50 Hz : 25 fps (1920 × 1080 , 1280 × 960 , 1280 × 720 , 704 × 576 , 640 × 480 , 352 × 288) 60 Hz : 30 fps (1920 × 1080 , 1280 × 960 , 1280 × 720 , 704 × 480 , 640 × 480 , 352 × 240)
Video Bit Rate	32 Kbps to 16384 Kbps
H.264 Type	Baseline Profile/Main Profile/High Profile
H.265 Type	Main Profile
Scalable Video Coding (SVC)	H.264 and H.265 encoding
Region of Interest (ROI)	8 fixed regions for each stream
Target Cropping	No
Audio	
Audio Compression	G.711alaw, G.711ulaw, G.722.1, G.726, MP2L2, PCM
Audio Bit Rate	64 Kbps (G.711)/16 Kbps (G.722.1)/16 Kbps (G.726)/32 to 192 Kbps (MP2L2)
Audio Sampling Rate	MP2L2: 16kHz, 32kHz, 48kHz, AAC-LC: 16kHz, 32kHz, 48kHz, PCM: 8kHz, 16kHz, 32kHz, 48kHz, MP3: 8kHz, 16kHz, 32kHz, 48kHz
Environment Noise Filtering	Yes
Network	
Smooth Streaming	Yes
Network Storage	NAS (NFS, SMB/ CIFS), ANR
Protocols	IPv4/IPv6, HTTP, HTTPS, 802.1x, Qos, FTP, SMTP, UPnP, SNMP, DNS, DDNS, NTP, RTSP, RTCP, RTP, TCP/IP, DHCP, PPPoE, UDP, IGMP, ICMP, Bonjour
API	ISUP, ISAPI, Hikvision SDK, Open Network Video Interface (Profile S, Profile G, Profile T, Profile M) , OTAP
Simultaneous Live View	Up to 20 channels
User/Host	Up to 32 users. 3 levels: Administrator, Operator and User
Security	Password protection, complicated password, HTTPS encryption, 802.1X authentication (EAP-TLS, EAP-LEAP, EAP-MD5), watermark, IP address filter, basic and digest authentication for HTTP/HTTPS, WSSE and digest authentication for Open Network Video Interface, RTP/RTSP over HTTPS, control timeout settings, security audit log, TLS 1.3, host authentication (MAC address), TPM 2.0 (FIPS 140-2 level 2)
Client	HikCentral, iVMS-4200, Hik-Connect
Web Browser	IE11, Chrome 57.0+, Firefox 52.0+, Safari 11+
Wireless (Mobile Communication)	
SIM	No
Image	
Image Parameters Switch	Yes
Image Settings	Saturation, brightness, contrast, sharpness, gain, and white balance adjustable by client software or web browser
Wide Dynamic Range (WDR)	120 dB
Day/Night Switch	Day, night, auto, scheduled-switch
Image Enhancement	BLC, HLC, 3D DNR

Defog	Digital defog
Image Stabilization	Yes. Built-in gyroscope to improve EIS performance.
Regional Exposure	Yes
Regional Focus	Yes
Privacy Mask	Up to 24 masks, polygon region, mosaic mask, mask color configurable
SNR	≥ 52 dB
Supplement Detection	
Gyroscope	Yes
Satellite Positioning	No
Compass	No
Interface	
Reset	Yes
Ethernet Interface	1 RJ45 10M/100M self-adaptive Ethernet port
On-board Storage	Built-in memory card slot, support MicroSD/MicroSDHC/MicroSDXC, up to 256 GB
Alarm	7 inputs, 2 outputs
Audio	1 input (line in), max. input amplitude: 2-2.4 vpp, input impedance: 1 K Ω \pm 10%; 1 output (line out), line level, output impedance: 600 Ω
Video Output	No
RS-485	Half duplex, HIKVISION, Pelco-P, Pelco-D, self-adaptive
Event	
Basic Event	Motion detection, video tampering alarm, exception (network disconnected, IP address conflict, illegal login, HDD full, HDD error), alarm input and output, vandal-proof alarm, audio exception detection, unattended baggage detection, object removal detection
Linkage	Upload to FTP/NAS/memory card, notify surveillance center, send email, trigger recording, and PTZ actions (such as preset, patrol scan, pattern scan)
Deep Learning Function	
Perimeter Protection	Line crossing detection, region entrance detection, intrusion detection, region exiting detection
Multi-Target-Type Detection	Supports simultaneous detection and capture of human body, face and vehicle
Linkage and Tracking	
Smart Tracking	Manual tracking, auto-tracking
General	
Vandal-proof Alarm	No
Heater	Yes
Wiper	Yes
De-icing	No
Demist	Yes
General Function	Mirror, password protection, watermark, IP address filter
Power	36 VDC \pm 25%, max. 60 W (Max. 45 W, including max. 7 W for IR and max. 8 W for heater) PoE 802.3bt, type3, class5, max. 45W (Max. 45 W, including max. 7 W for IR and max. 8 W for heater)
Operating Condition	-40 $^{\circ}$ C to 70 $^{\circ}$ C (-40 $^{\circ}$ F to 158 $^{\circ}$ F). Humidity 95% or less (non-condensing)
Dimension	\varnothing 218.4 mm \times 324.2 mm (\varnothing 8.6" \times 12.76")
Weight	Approx. 5 kg (11.02 lb.)

Language	33 languages: English, Russian, Estonian, Bulgarian, Hungarian, Greek, German, Italian, Czech, Slovak, French, Polish, Dutch, Portuguese, Spanish, Romanian, Danish, Swedish, Norwegian, Finnish, Croatian, Slovenian, Serbian, Turkish, Korean, Traditional Chinese, Thai, Vietnamese, Japanese, Latvian, Lithuanian, Portuguese (Brazil), Ukrainian
Approval	
EMC	CE-EMC (EN 55032:2015, EN 61000-3-2:2019, EN 61000-3-3:2013 + A1:2019, EN 50130-4:2011 + A1:2014), RCM (AS/NZS CISPR 32:2015), IC VoC (ICES-003: Issue 6, 2019), KC (KN 32:2015, KN 35:2015)
Safety	CB (IEC 62368-1:2014 + A11), CE-LVD (EN 62368-1:2014/A11:2017), BIS (IS 13252 (Part 1):2010/IEC 60950-1:2005), LOA (IEC/EN 60950-1)
Environment	CE-RoHS (2011/65/EU); WEEE (2012/19/EU); Reach (Regulation (EC) No 1907/2006)
Protection	IP67 (IEC 60529:2013), IK10 (IEC 62262:2002)

▪ DORI

The DORI (detect, observe, recognize, identify) distance gives the general idea of the camera ability to distinguish persons or objects within its field of view.

It is calculated based on the camera sensor specification and the criteria given by EN 62676-4:2015.

DORI	Detect	Observe	Recognize	Identify
Definition	25 px/m	63 px/m	125 px/m	250 px/m
Distance (Tele)	3600.0m(11811.02ft)	1428.6m(4687.01ft)	720.0m(2362.20ft)	360.0m(1181.10ft)

▪ Typical Application

Hikvision products are classified into three levels according to their anti-corrosion performance. Refer to the following description to choose for your using environment.

This model has NO SPECIFIC PROTECTION.

Level	Description
Top-level protection	Hikvision products at this level are equipped for use in areas where professional anti-corrosion protection is a must. Typical application scenarios include coastlines, docks, chemical plants, and more.
Moderate protection	Hikvision products at this level are equipped for use in areas with moderate anti-corrosion demands. Typical application scenarios include coastal areas about 2 kilometers (1.24 miles) away from coastlines, as well as areas affected by acid rain.
No specific protection	Hikvision products at this level are equipped for use in areas where no specific anti-corrosion protection is needed.

▪ Available Model

DS-2DF6C445IWG1-ELW

DS-2DF6C445IWG1-ELW(BRA TELETEx)

DS-2DF6C445IWG1-EL

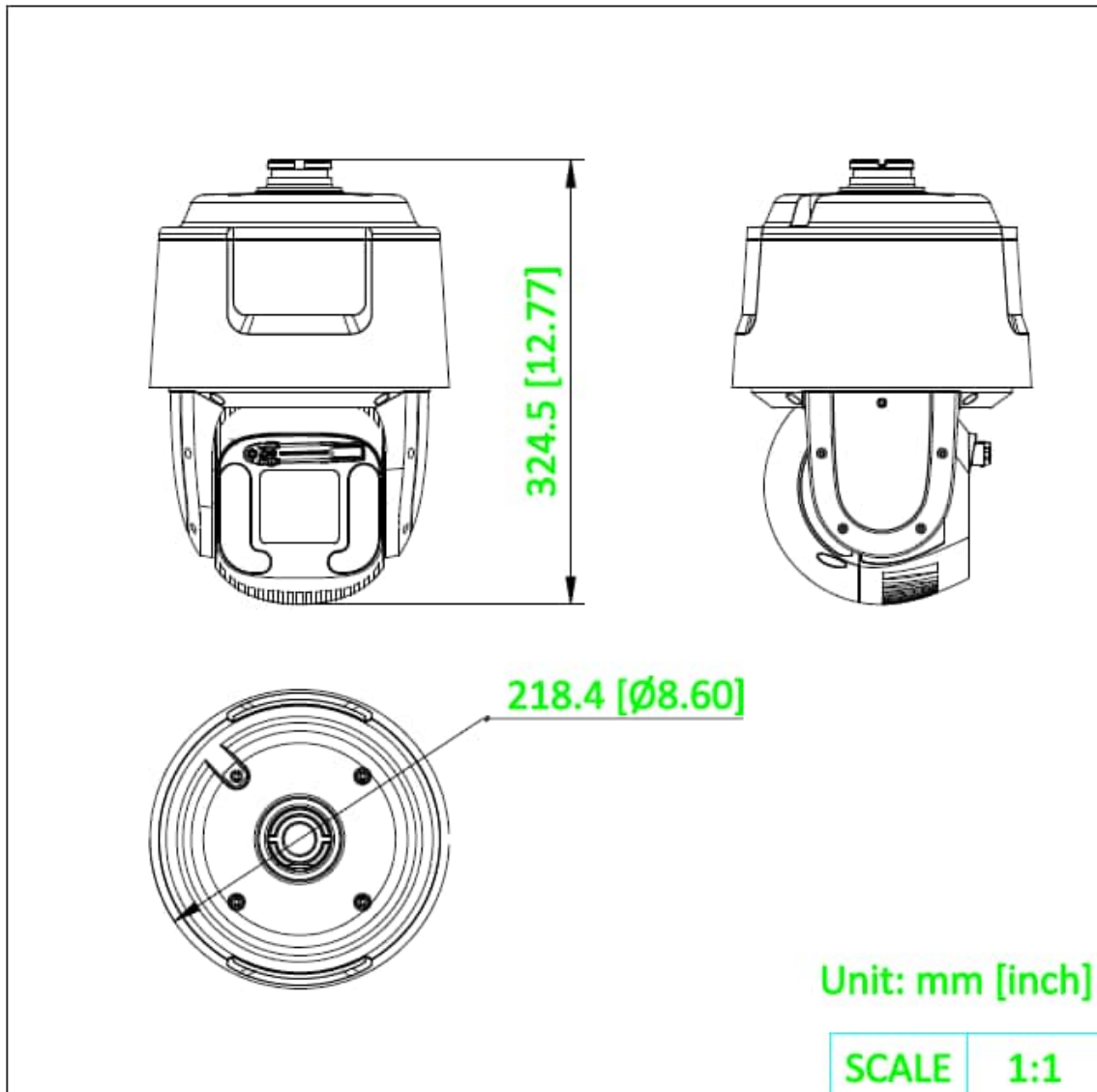

▪ Dimension







▪ Accessory

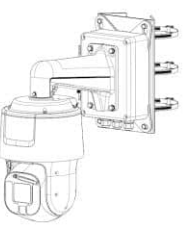

▪ Optional

DS-4650ZJ-WC	DS-1604ZJ-corner	DS-1276ZJ	DS-1662ZJ	DS-1673ZJ
DS-1674ZJ	DS-1604ZJ-pole	DS-4660ZJ-WC	DS-1602ZJ	DS-1663ZJ

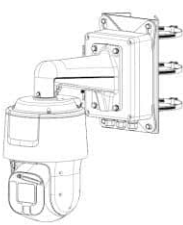
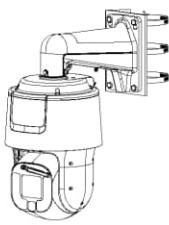
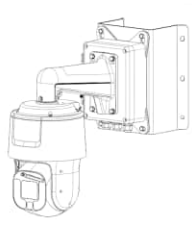
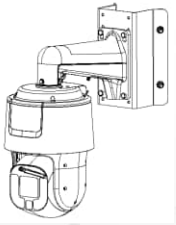
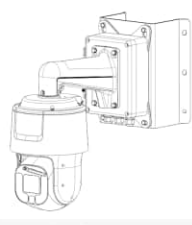
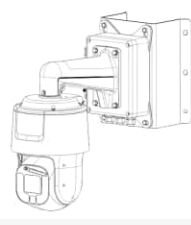
				
DS-1604ZJ-BOX-CO RNER	DS-1604ZJ	DS-1604ZJ-box	DS-1667ZJ	DS-1604ZJ-BOX-PO LE
				
DS-1684ZJ	DS-1660ZJ	DS-1619ZJ	DS-1661ZJ	
				

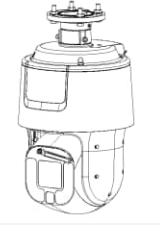
Installation Methods

Vertical Pole Mounting DS-4650ZJ-WC+DS-16 74ZJ+DS-1602ZJ	Vertical Pole Mounting DS-1604ZJ-pole	Vertical Pole Mounting DS-1604ZJ-BOX-POLE	Vertical Pole Mounting DS-1684ZJ+DS-1602ZJ	Corner Mounting DS-1604ZJ-corner
				
Corner Mounting DS-1276ZJ+DS-1602ZJ	Corner Mounting DS-4660ZJ-WC+DS-16 02ZJ+DS-1674ZJ	Corner Mounting DS-1604ZJ-BOX-CORN ER	Pendant Mounting DS-1662ZJ	Pendant Mounting DS-1663ZJ
				

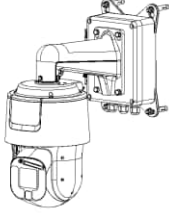
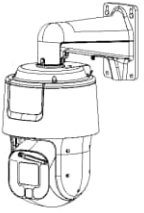
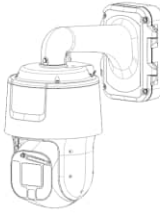
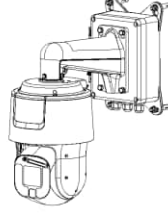
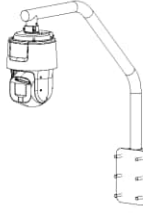
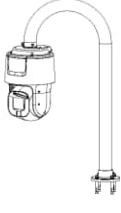
Pendant Mounting DS-1667ZJ	Pendant Mounting DS-1661ZJ	Horizontal Pole Mounting DS-1673ZJ+DS-1661ZJ	Junction Box DS-1674ZJ+DS-1602ZJ	Wall Mounting DS-1602ZJ
				
Wall Mounting DS-1604ZJ	Wall Mounting DS-1604ZJ-box	Gooseneck Mounting DS-1660ZJ	Gooseneck Mounting DS-1619ZJ	
				

See Far, Go Further



www.hikvision.com
support@hikvision.com

