

DS-2CD6395G1E-IVS
9 MP DeepinView IR Network Fisheye Camera

DeepinView^{series}

HEOP



DS-2CD6395G1E-IVS is a fisheye network camera capable of providing a 360-degree panoramic image of its scene. The progressive scan CMOS sensor provides high-resolution images of up to 3024 × 3024. Up to 20 live view display modes, designed for 3 mount types, meet various user preferences. Three independently controlled IR lights offer a range of 15 m and provide good vision in low or even zero-light environment.

- Heatmap: based on deep learning algorithms, the camera counts people and presents an intuitive map
- Multi dewarping modes: the image can be dewarped to normal image for viewing intuitively
- Built-in mic and speaker: the camera supports two-way audio for real-time audio security monitoring and communication
- Built-in IR light: an IR range of 15 meters provides good visibility in low or even zero-light environments
- High resolution 9 MP: capturing clear images even when dewarped into 4-image PTZ mode
- Each image is clear and detailed
- Water and dust resistant (IP67) and vandal resistant (IK10)

▪ Specification

Camera	
Image Sensor	1/1.8" Progressive Scan CMOS
Max. Resolution	3024 × 3024
Min. Illumination	Color: 0.01 Lux @ (F2.25, AGC ON),B/W: 0.005 Lux @ (F2.25, AGC ON),B/W: 0 Lux with IR
Shutter Time	1 s to 1/100,000 s
Day & Night	IR cut filter
Lens	
Lens Type	Fixed focal lens, 2 mm
Focal Length & FOV	2 mm, 360° panoramic view
Iris Type	Fixed
Aperture	F2.25
Depth of Field	0.2 m to ∞
DORI	
DORI	D: 23.2 m O: 9.2 m R: 4.6 m I: 2.3 m
Illuminator	
Supplement Light Type	IR
Supplement Light Range	Up to 15 m
Supplement Light Number	3
Smart Supplement Light	Yes
IR Wavelength	850 nm
HEOP	
Open Resources	Memory: 41 MB, Smart RAM: 180 MB
Computing Power	2 TOPS
Open Capability	HEOP 2.0 OpendevSDK
Deep Learning Structure	Caffe, TensorFlow, PyTorch
Programming Language	C, C++

Video	
Main Stream	50 Hz: 25 fps/60 Hz: 30 fps: Fisheye View: 3024 × 3024, 2560 × 2560, 2048 × 2048 180 Panorama View: 3072 × 2304, 2048 × 1536 180 Dual Channel Panorama View: 3072 × 1152 Panorama View: 3072 × 2304, 2048 × 1536 4PTZ View: camera 01/camera 02/camera 03/camera 04: 1600 × 1200 Fisheye + 3PTZ View: camera 01: 2560 × 2560, 2048 × 2048, 1280 × 1280 camera 02/camera 03/camera 04: 1600 × 1200 4PTZ Fusion View: 3200 × 2400, 2048 × 1536
Sub-Stream	50 Hz: 25 fps/60 Hz: 30 fps: Fisheye View: 720 × 720, 480 × 480 180 Panorama View: 640 × 480, 320 × 240 180 Dual Channel Panorama View: 640 × 480, 320 × 240 Panorama View: 640 × 360, 320 × 240 4PTZ View: camera 01/camera 02/camera 03/camera 04: 640 × 480, 320 × 240 Fisheye + 3PTZ View: camera 01: 720 × 720 camera 02/camera 03/camera 04: 640 × 480, 320 × 240
Video Compression	Main stream: H.265+/H.265/H.264+/ H.264, Sub-stream: H.265/H.264/MJPEG
Video Bit Rate	32 Kbps to 16 Mbps
H.264 Type	Baseline Profile,Main Profile,High Profile
H.265 Type	Main Profile
Bit Rate Control	CBR,VBR
Scalable Video Coding (SVC)	H.264 and H.265 encoding
Region of Interest (ROI)	4 fixed regions for each stream
Fisheye Display	
Mount Type	Support wall/table/ceiling mounting
Decoding Mode	Support hardware decoding and software decoding

Display Mode	20 display modes in total, Software decoding: fisheye view, 180 panorama view, 360 panorama view, 360 panorama + PTZ, 360 panorama + 3PTZ, 360 panorama + 6PTZ, 360 panorama + 8PTZ, 2PTZ, 4PTZ, fisheye + 3PTZ, fisheye + 8PTZ, hemisphere, AR hemisphere, cylinder, Hardware decoding: fisheye view, 180 panorama view, 180 dual channel panorama, panorama view, 4PTZ, fisheye + 3PTZ, 4PTZ fusion
Audio	
Audio Compression	G.711/G.722.1/G.726/MP2L2/PCM/MP3/AAC-LC
Audio Bit Rate	64 Kbps (G.711ulaw/G.711alaw)/16 Kbps (G.722.1)/16 Kbps (G.726)/32 to 192 Kbps (MP2L2)/8 to 320 Kbps (MP3)/16 to 64 Kbps (AAC-LC)
Audio Sampling Rate	8 kHz/16 kHz/32 kHz/48 kHz
Environment Noise Filtering	Yes
Network	
Protocols	TCP/IP, ICMP, HTTP, HTTPS, FTP, SFTP, DHCP, DNS, DDNS, RTP, RTSP, RTCP, PPPoE, NTP, UPnP, SMTP, SNMP, IGMP, 802.1X, QoS, IPv4, IPv6, UDP, Bonjour, SSL/TLS, ISUP, ARP, WebSocket, WebSockets, SIP
Simultaneous Live View	Up to 20 channels
API	Open Network Video Interface (Profile S, Profile G, Profile T),ISAPI,SDK,ISUP, Support for Session Initiation Protocol (SIP) for integration with Voice over IP (VoIP) systems, peer to peer or integrated with SIP/PBX
User/Host	Up to 32 users 3 user levels: administrator, operator, and user
Security	Password protection, complicated password, HTTPS encryption, 802.1X authentication (EAP-TLS, EAP-LEAP, EAP-MD5), watermark, IP address filter, basic and digest authentication for HTTP/HTTPS, WSSE and digest authentication for Open Network Video Interface, RTP/RTSP over HTTPS, control timeout settings, security audit log, TLS 1.2, host authentication (MAC address), TPM 2.0 (FIPS 140-2 level 2)
Network Storage	NAS (NFS, SMB/CIFS),Auto Network Replenishment (ANR), Together with high-end Hikvision memory card, memory card encryption and health detection are supported.
Client	iVMS-4200,iVMS-4500,iVMS-5200,Hik-Connect
Web Browser	Plug-in required live view: IE 10, IE 11, Plug-in free live view: Chrome 57.0+, Firefox 52.0+, Edge 89+, Safari 11+, Local service: Chrome 57.0+, Firefox 52.0+, Edge 89+
Image	
Image Parameters Switch	Yes
Image Settings	saturation,brightness,contrast,sharpness,white balance,AGC,adjustable by client software or web browser
Day/Night Switch	Day,Night,Auto,Schedule,Alarm Trigger
Wide Dynamic Range (WDR)	Digital WDR
Image Enhancement	BLC,HLC,3D DNR,Distortion Correction,Defog
Privacy Mask	8 programmable polygon privacy masks
Picture Overlay	LOGO picture can be overlaid on video with 128 × 128 24 bit bmp format.
Interface	
Ethernet Interface	1 RJ45 10 M/100 M self-adaptive Ethernet port
On-Board Storage	Built-in memory card slot, support microSD/microSDHC/microSDXC card, up to 512 GB

Built-in Microphone	Yes, 2 built-in microphones
Built-in Speaker	Yes, 1 built-in speaker
Audio	1 input (line in), 3.5 mm connector, max. input amplitude: 3.3 Vpp, input impedance: 4.7 K Ω , interface type: non-equilibrium, 1 output (line out), 3.5 mm connector, max. output amplitude: 3.3 Vpp, output impedance: 100 Ω , interface type: non-equilibrium
Alarm	1 inputs, 1 outputs (max. 24 VDC, 1 A)
RS-485	1 RS-485 (Half duplex, HIKVISION, Pelco-P, Pelco-D, self-adaptive)
Reset Key	1 Reset Key
Event	
Basic Event	Motion detection,video tampering alarm,alarm input and output,exception (network disconnected, IP address conflict, illegal login, HDD full, HDD error)
Smart Event	Line crossing detection, intrusion detection, region entrance detection, region exiting detection, scene change detection,audio exception detection,defocus detection, unattended baggage detection,object removal detection
Linkage	Upload to FTP/NAS/memory card,notify surveillance center,send email,trigger alarm output,trigger recording,trigger capture
Deep Learning Function	
Heat Map	A graphic description of visits (by calculating amount of people or amount of dwell time) in a configured area., Two report types are available, space heat map and time heat map line chart.
General	
Power	12 VDC \pm 20%, 0.8 A, max. 9.6 W,two-core terminal block, PoE: IEEE 802.3af, Class 3, max. 9.6 W
Material	Metal
Dimension	\varnothing 140.3 mm \times 59.4 mm (\varnothing 5.5" \times 2.3")
Package Dimension	260 mm \times 230 mm \times 135 mm (10.2" \times 9.1" \times 5.3")
Weight	Approx. 715 g (1.58 lb.)
With Package Weight	Approx. 1206 g (2.66 lb.)
Storage Conditions	-30 $^{\circ}$ C to 60 $^{\circ}$ C (-30 $^{\circ}$ F to 140 $^{\circ}$ F). Humidity 95% or less (non-condensing)
Startup and Operating Conditions	-30 $^{\circ}$ C to 60 $^{\circ}$ C (-30 $^{\circ}$ F to 140 $^{\circ}$ F). Humidity 95% or less (non-condensing)
Language	33 languages: English, Russian, Estonian, Bulgarian, Hungarian, Greek, German, Italian, Czech, Slovak, French, Polish, Dutch, Portuguese, Spanish, Romanian, Danish, Swedish, Norwegian, Finnish, Croatian, Slovenian, Serbian, Turkish, Korean, Traditional Chinese, Thai, Vietnamese, Japanese, Latvian, Lithuanian, Portuguese (Brazil), Ukrainian
General Function	Heartbeat,flash log,password reset via email,password protection,one-key reset,anti-banding
Cable Length	0.31 m (1.02 ft.)
Approval	
EMC	CE-EMC: EN 55032:2015+A1:2020, EN 50130-4:2011+A1:2014, EN IEC 61000-3-2:2019+A1:2021, EN 61000-3-3:2013+A1:2019+A2:2021, EN 50121-4: 2016+A1:2019, RCM: AS/NZS CISPR 32: 2015, IC: ICES-003: Issue 7, KC: KN32: 2015, KN35: 2015

Safety	UL: UL 62368-1, CB: IEC 62368-1: 2014+A11, CE-LVD: EN 62368-1: 2014/A11: 2017, BIS: IS 13252 (Part 1): 2010/IEC 60950-1: 2005
Environment	CE-RoHS: 2011/65/EU, WEEE: 2012/19/EU, Reach: Regulation (EC) No 1907/2006
Protection	IP67: IEC 60529-2013,IK10: IEC 62262:2002

▪ Typical Application

Hikvision products are classified into three levels according to their anti-corrosion performance. Refer to the following description to choose for your using environment.

This model has NO SPECIFIC PROTECTION.

Level	Description
Top-level protection	Hikvision products at this level are equipped for use in areas where professional anti-corrosion protection is a must. Typical application scenarios include coastlines, docks, chemical plants, and more.
Moderate protection	Hikvision products at this level are equipped for use in areas with moderate anti-corrosion demands. Typical application scenarios include coastal areas about 2 kilometers (1.24 miles) away from coastlines, as well as areas affected by acid rain.
No specific protection	Hikvision products at this level are equipped for use in areas where no specific anti-corrosion protection is needed.

▪ Physical Interface

No.	Interface Description
1	Network Interface
2	Power Interface
3	Alarm Interface, RS-485
4	Audio Output Interface
5	Audio Input Interface

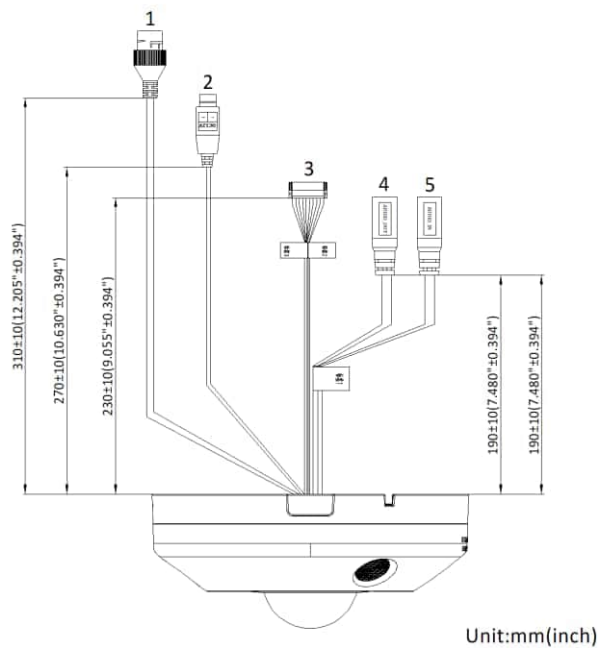

Unit:mm(inch)

▪ Available Model

DS-2CD6395G1E-IVS(2mm)

▪ Dimension

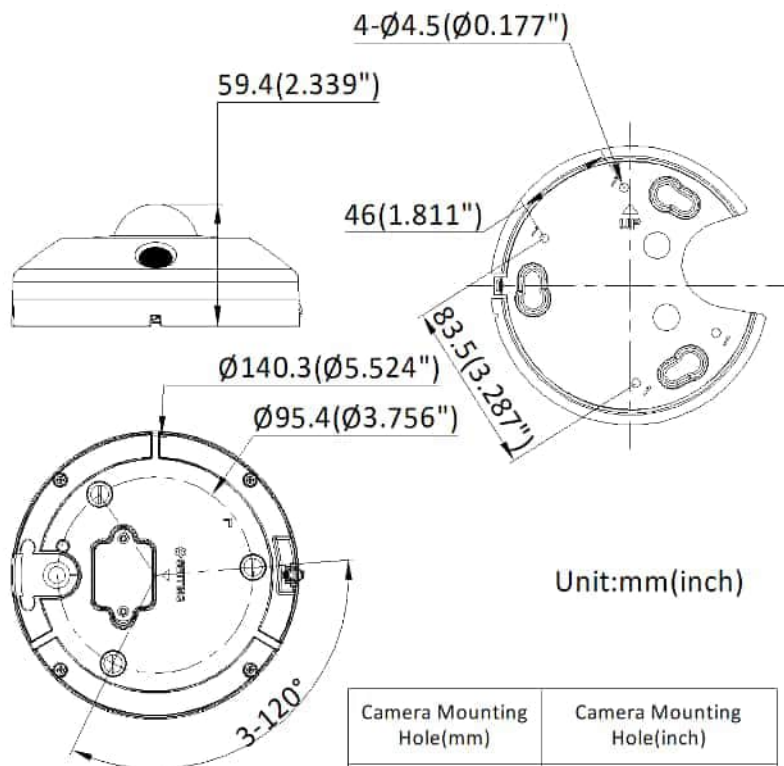









Unit:mm(inch)

Camera Mounting Hole(mm)	Camera Mounting Hole(inch)
4xØ4.5	4xØ0.177"

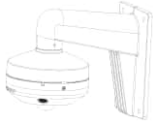
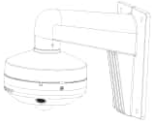
▪ **Accessory**

▪ **Optional**

DS-1273ZJ-140 Wall mount	DS-1273ZJ-140B Wall mount	DS-1271ZJ-140 Pendant Mount	DS-1275ZJ-SUS Vertical pole mount	DS-1276ZJ-SUS Corner mount
				
				
DS-2280ZJ-WA140 Junction box				
				
				

Headquarters

No.555 Qianmo Road, Binjiang District,
Hangzhou 310051, China
T +86-571-8807-5998
www.hikvision.com



Follow us on social media to get the latest product and solution information.

