

Quick Start Guide

GV-GPH2800



Before attempting to connect or operate this product, please read these instructions carefully and save this manual for future use.

TPH-QG-A



© 2023 GeoVision, Inc. All rights reserved.

Under the copyright laws, this manual may not be copied, in whole or in part, without the written consent of GeoVision.

Every effort has been made to ensure that the information in this manual is accurate. GeoVision, Inc. makes no expressed or implied warranty of any kind and assumes no responsibility for errors or omissions. No liability is assumed for incidental or consequential damages arising from the use of the information or products contained herein. Features and specifications are subject to change without notice.

GeoVision, Inc.
9F, No. 246, Sec. 1, Neihu Rd.,
Neihu District, Taipei, Taiwan
Tel: +886-2-8797-8377
Fax: +886-2-8797-8335
<http://www.geovision.com.tw>

Trademarks used in this manual: *GeoVision*, the *GeoVision* logo and *GV* series products are trademarks of GeoVision, Inc. *Windows* is the registered trademark of Microsoft Corporation.

September 2023

Scan the following QR codes for product warranty and technical support policy:



[Warranty]



[Technical Support Policy]

Warning and Caution

- If the product does not work properly, please contact your dealer or the nearest service center. Never attempt to disassemble the camera yourself. (We shall not be responsible for any problems caused by unauthorized repair or maintenance.)
- Keep away from liquid while in use.
- In the use of the product, you must be strict compliance with the electrical safety regulations of the nation and region. When the product is mounted on wall, the device shall be firmly fixed.
- Do not use the device beyond specified voltage range.
- Do not drop the camera or subject it to physical shock.
- Avoid touching the camera lens.
- If cleaning is necessary, please use clean cloth to wipe it gently.
- Do not aim the camera at the sun or extra bright place.
- Do not place the camera in extremely hot, cold, dusty or damp locations, and do not expose it to high electromagnetic radiation.
- To avoid heat accumulation, good ventilation is required for operating environment.
- A few parts of the device shall be replaced regularly according to their average enduring time. Regular checking is recommended for all users.

Contents

1. Overview.....	1
2. Installation.....	2
3. Connection.....	5
4. Accessing the Network Camera	6
4.1 Looking Up the Dynamic IP Address	6
4.2 Configuring the IP Address	8
5. The Web Interface.....	9
6. Upgrading System Firmware	11
7. Restoring to Factory Default	12

1. Overview

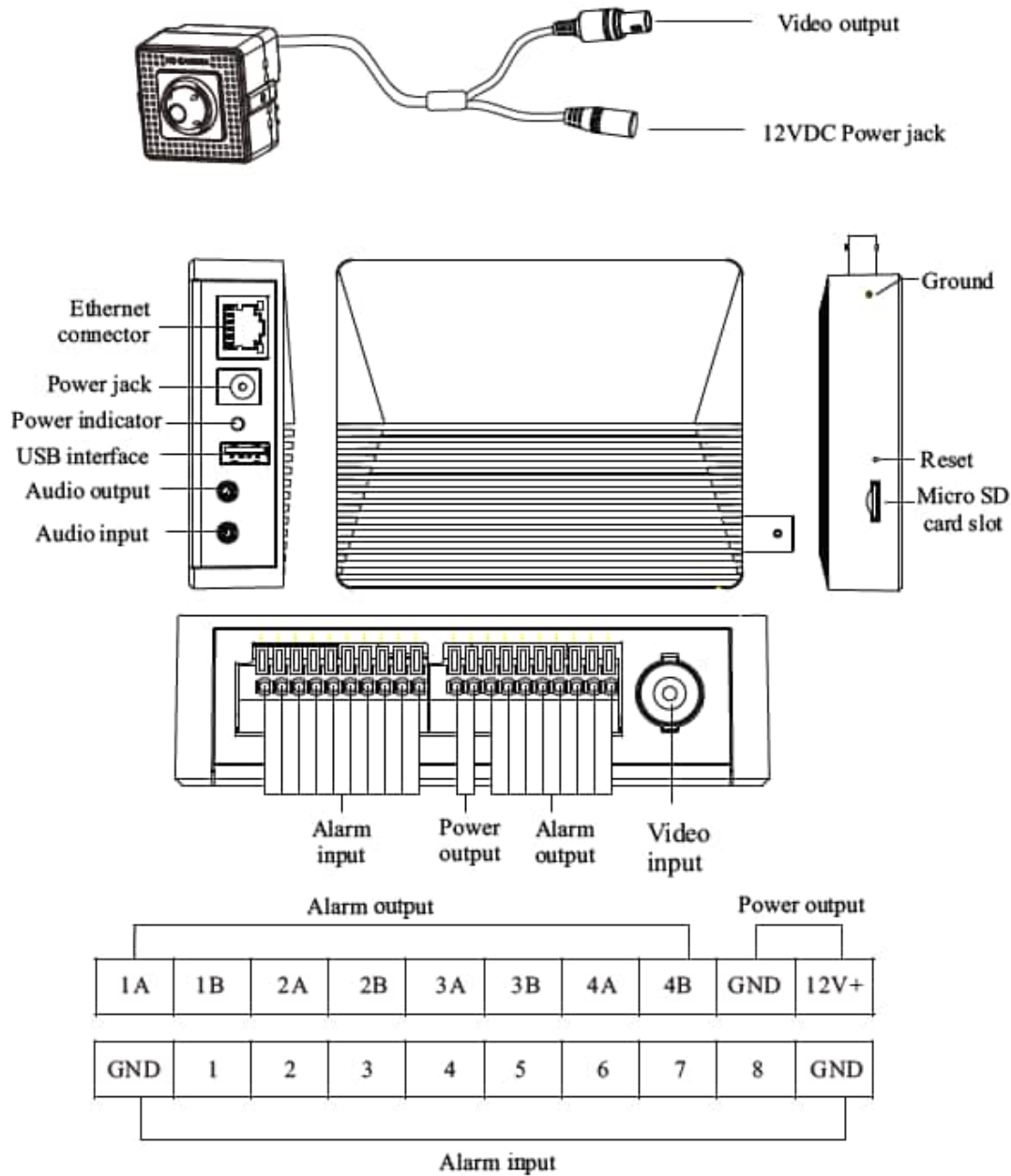

Note:

1. The camera can be powered either with a DC 12 V power supply or by connecting to the main body's power output ports.
2. To load default settings, press and hold the default button for 10 seconds.
3. The USB port is currently not functional.

2. Installation

Part 1

1. Secure the bracket 1 to the wall with the screw provided.

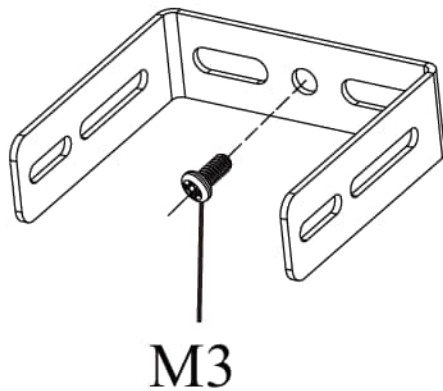

2. Route and connect the cables.
3. Fasten the camera to the bracket 1 with screws as shown below. Before tightening the screws, please adjust the viewing angle of the camera first.

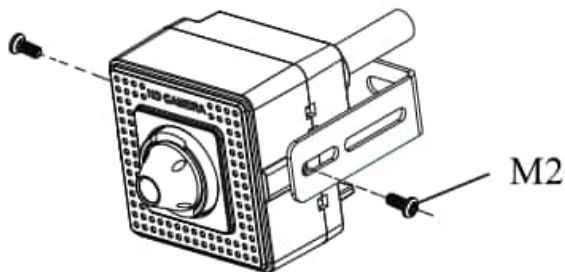

4. Tighten the screws firmly to finish the installation.

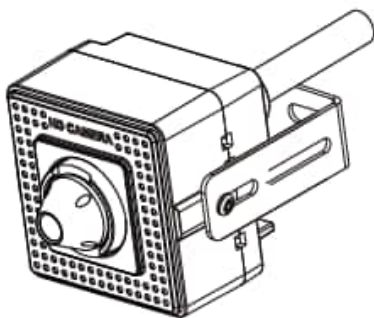

Part 2

1. Drill the screw holes on the wall according to the drill template.

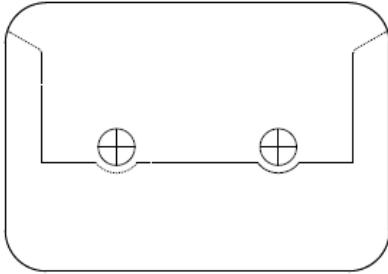

2. Insert two screw anchors.

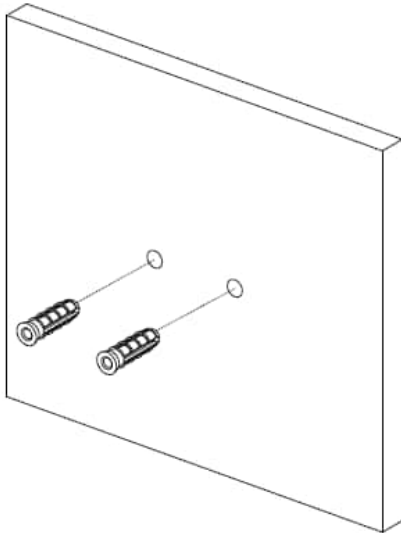

3. Secure the bracket 2 onto the wall with two tapping screws.

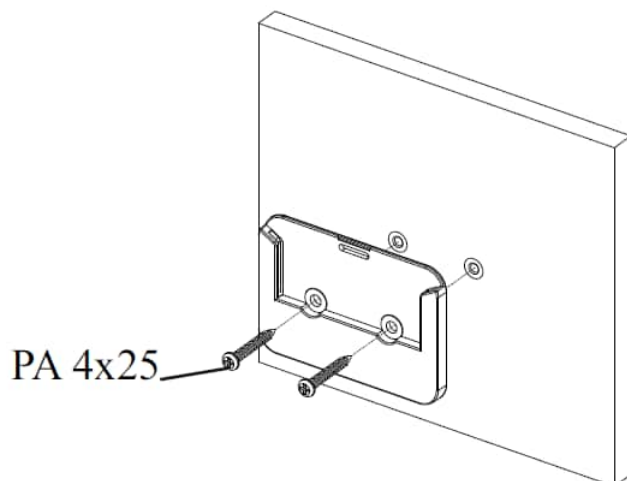

4. Install the bracket 3 to the device with two machine screws as shown below.

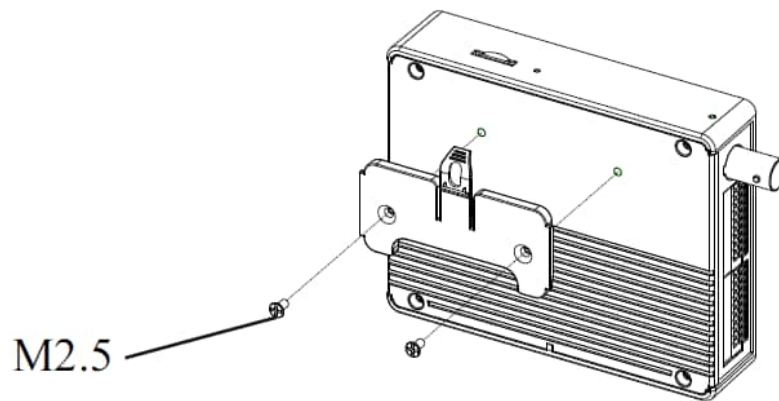

5. Hook the device to the bracket 2. The device will be locked when a click is heard.

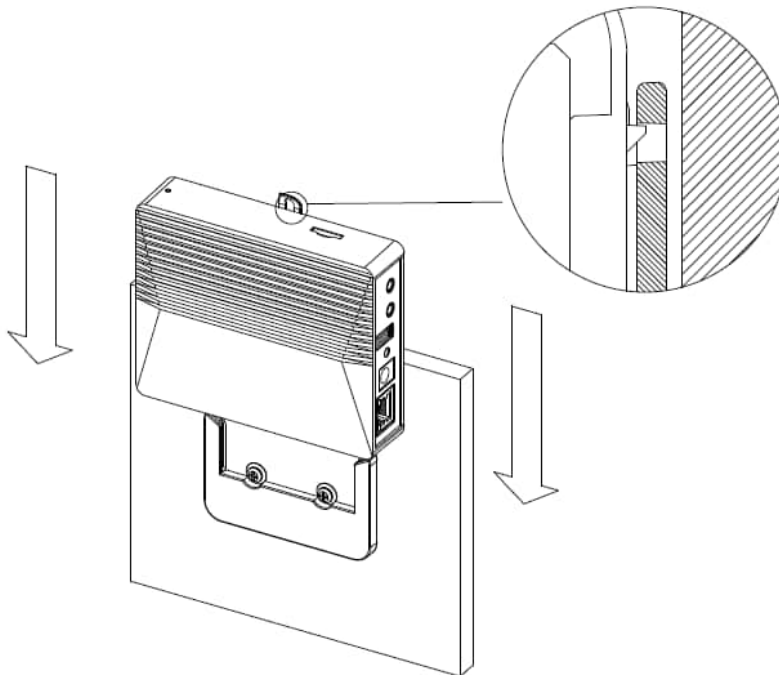

3. Connection

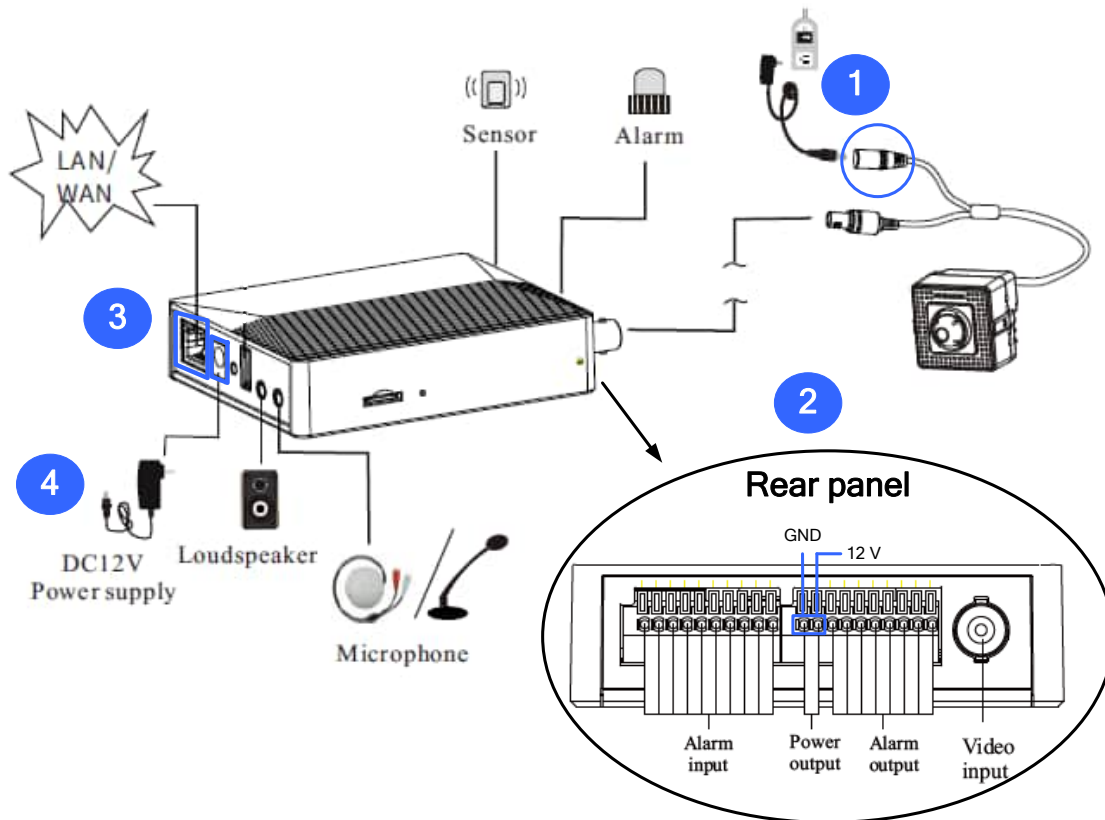

Powering the camera

Power the camera by adopting the two alternatives:

1. Connect a DC 12 V power adapter to the camera.
2. Connect two power wires (+, -) from the camera to the power output ports (12 V, GND) on the main body.

Powering the main body

Power the main body by adopting the two alternatives:

3. Connect an Ethernet cable to the main body's PoE port.
4. Connect a DC 12 V power adapter to the main body.

Note:

1. The USB port is currently not functional.
2. The main body's power output is DC 12 V, 0.5 A (Max. 5.5 W).

4. Accessing the Network Camera

4.1 Looking Up the Dynamic IP Address

By default, when the camera is connected to a LAN with the DHCP server, it is automatically assigned with a dynamic IP address. Follow the steps below to look up its IP address.

Note:

1. By default, the Administrator's username is **admin** and cannot be modified.
 2. This function is only applicable on GV-IP Device Utility V8.9.8 or later.
-

1. Make sure the PC used to configure the IP address is under the same LAN as the camera. Download and install **GV-IP Device Utility** from the company [website](#).
2. On the GV-IP Utility window, click the  button to search for the IP devices connected in the same LAN. Click the **Name** or **Mac Address** column to sort.
3. Find the camera with its Mac Address, and click on its IP address.

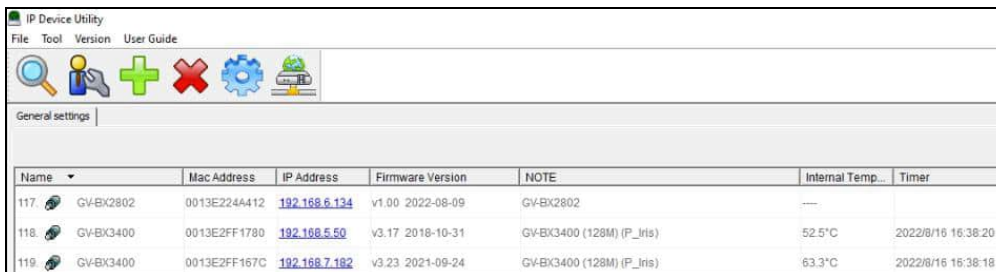

Name	Mac Address	IP Address	Firmware Version	NOTE	Internal Temp...	Timer
117	GV-BX2802 0013E224A412	192.168.6.134	v1.00 2022-08-09	GV-BX2802	---	
118	GV-BX3400 0013E2FF1780	192.168.5.50	v3.17 2018-10-31	GV-BX3400 (128M) (P_Iris)	52.5°C	2022/8/16 16:38:20
119	GV-BX3400 0013E2FF167C	192.168.7.182	v3.23 2021-09-24	GV-BX3400 (128M) (P_Iris)	63.3°C	2022/8/16 16:38:19

4. For first-time users, you are requested to create a password.

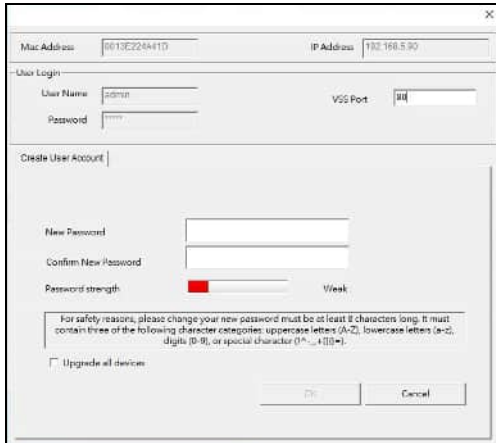

5. Type a new password and click **OK**.
6. Click on its IP address again and select **Webpage** to open its Web interface.
7. Type the set password on the login page and click **Login**.

Note: To change the password using GV-IP Device Utility, click on the camera's IP address, and select **Configure > Change Password**. Or you can optionally change the password on the camera's Web interface by clicking **Config → Security → User** ; see "Modify User" in *5.6.1 User Configuration* in the user's manual.

4.2 Configuring the IP Address

If the camera is connected to a LAN without the DHCP server, the default IP address will be **192.168.0.10**. Follow the steps below to modify the IP address to avoid IP conflict with other GV-IP devices on the same LAN.

1. Open your Web browser, and type the default IP address **192.168.0.10**.
2. Type the default username **admin** and a password. Click **Login**.
3. Go to **Config > Network > TCP/IP** to set the IP address.
4. Select **Use the following IP address** and then enter the static IP address and other parameters.







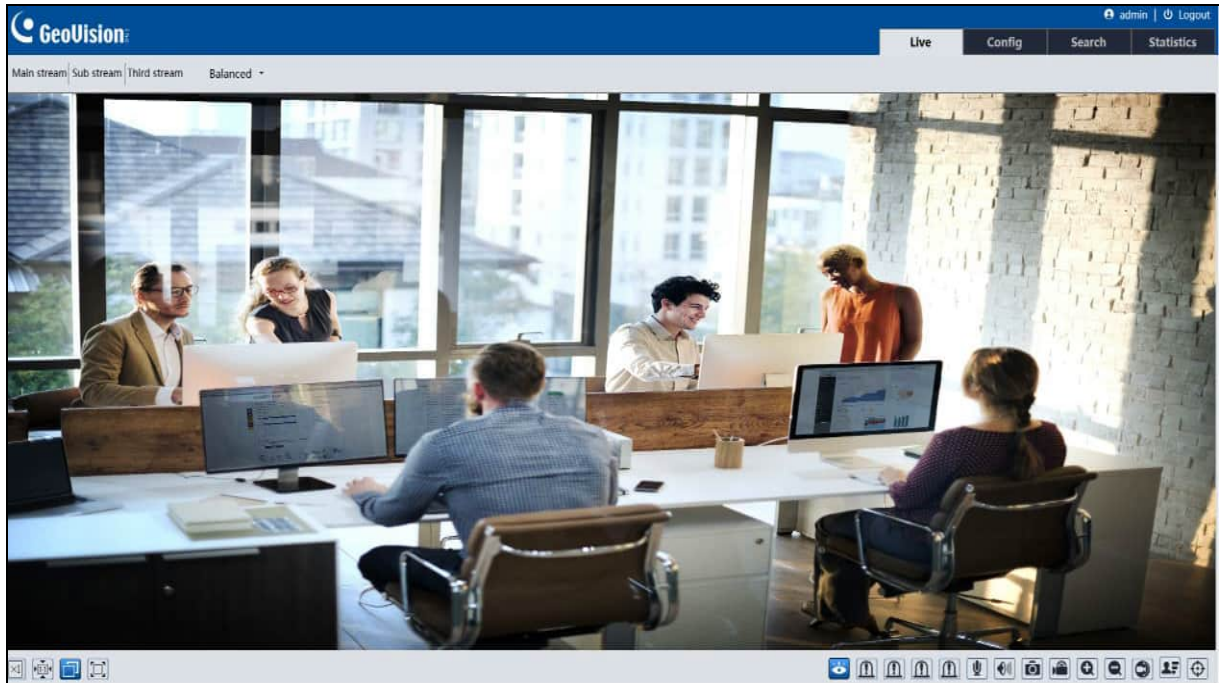





















IPv4	IPv6	PPPoE Config	IP Change Notification Config
<input type="radio"/> Obtain an IP address automatically			
<input checked="" type="radio"/> Use the following IP address			
IP Address	<input type="text" value="192.168.226.201"/>	<input type="button" value="Test"/>	
Subnet Mask	<input type="text" value="255.255.255.0"/>		
Gateway	<input type="text" value="192.168.226.1"/>		
Preferred DNS Server	<input type="text" value="210.21.196.6"/>		
Alternate DNS Server	<input type="text" value="8.8.8.8"/>		



5. The Web Interface

Once you log in the Web interface, you will see the live view as shown below.



The following table is the instructions of the icons on the live view interface.

Icon	Description	Icon	Description
	Original size		SD card recording indicator
	Fit correct scale		Sensor alarm indicator
	Auto (fill the window)		Motion alarm indicator
	Full screen		Color abnormal indicator
	Start/stop live view		Abnormal clarity indicator
	Start/stop two-way audio		Scene change indicator
	Enable/disable audio		Line Crossing indicator
	Snapshot		Region Intrusion indicator
	Start/stop local recording		Region Entrance indicator
	Zoom in		Region Exiting indicator
	Zoom out		Face detection indicator
	Enable/disable alarm output		Target counting (by line) indicator
	Face capture		Target counting (by area) indicator
	Rule information display		Object detection indicator (object abandoned/missing)

Icon	Description	Icon	Description
	Alarm output indicator		Heat map indicator
	COC (UTC) control		

For detailed information, see the user's manual.

6. Upgrading System Firmware

GeoVision periodically releases updated firmware on the company [website](#). To load the new firmware into the camera, follow the instructions below.

1. On the Web interface, click **Config > Maintenance > Upgrade**.

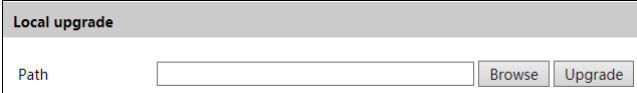

The screenshot shows a web interface titled "Local upgrade". It features a text input field labeled "Path" with a "Browse" button to its right. To the right of the "Browse" button is an "Upgrade" button.

2. Click the **Browse** button to locate the firmware file saved at your local computer.
3. Click the **Upgrade** button to start upgrading the firmware.
4. After upgrading, the camera will restart automatically.

Note: Do not close the browser or disconnect the camera from the network during the upgrade.

7. Restoring to Factory Default

If for any reason the camera is not responding correctly, you can restore the camera back to its factory default settings using the Web interface or the Load Default Button.

On the Device Main Body

1. Find the **Reset** button on the camera (see *1. Overview* in the Quick Start Guide).
2. Press and hold the button for more than 10 seconds to restore to the factory default setting.

On the Web Interface

1. On the Web interface, click **Config > Maintenance > Backup and Restore**.
2. Click the **Load Default** button to restore all system settings to factory default, except the image settings (see *5.2 Image Configuration* in the *User's Manual* for details) you want to keep.

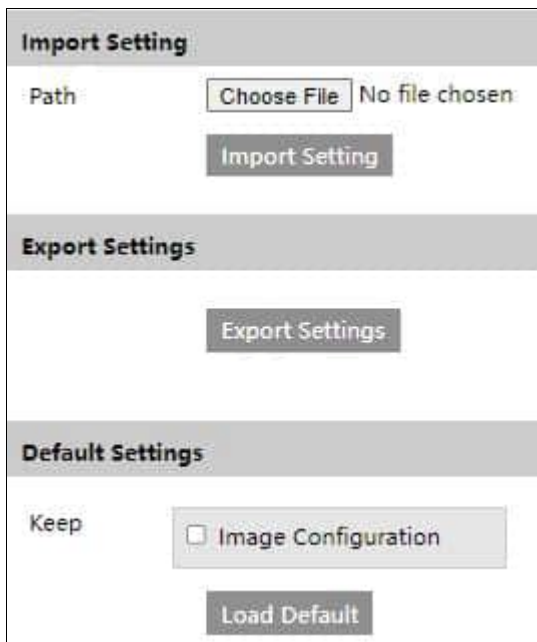

The screenshot shows a web interface with three main sections: 'Import Setting', 'Export Settings', and 'Default Settings'. The 'Import Setting' section includes a 'Path' field with a 'Choose File' button and 'No file chosen' text, and an 'Import Setting' button. The 'Export Settings' section has an 'Export Settings' button. The 'Default Settings' section has a 'Keep' label, a checkbox for 'Image Configuration' (which is unchecked), and a 'Load Default' button.