

GV-GF Fingerprint Reader

User's Manual



Before attempting to connect or operate this product, please read these instructions carefully and save this manual for future use.



© 2024 GeoVision, Inc. All rights reserved.

Under the copyright laws, this manual may not be copied, in whole or in part, without the written consent of GeoVision.

Every effort has been made to ensure that the information in this manual is accurate. GeoVision, Inc. makes no expressed or implied warranty of any kind and assumes no responsibility for errors or omissions. No liability is assumed for incidental or consequential damages arising from the use of the information or products contained herein. Features and specifications are subject to change without notice.

GeoVision, Inc.
9F, No. 246, Sec. 1, Neihu Rd.,
Neihu District, Taipei, Taiwan
Tel: +886-2-8797-8377
Fax: +886-2-8797-8335
<http://www.geovision.com.tw>

Trademarks used in this manual: *GeoVision*, the *GeoVision* logo and *GV* series products are trademarks of GeoVision, Inc. *Windows* is the registered trademark of Microsoft Corporation.

July 2024

Scan the following QR codes for product warranty and technical support policy:



[Warranty]



[Technical Support Policy]

Preface

Welcome to the *GV-GF Fingerprint Reader User's Manual*.

This Manual applies to the following GV-GF Fingerprint Readers:

Product	Version
GV-GF1911 / 1912	V1.0
GV-GF1921 / 1922	V1.31
GV-GF1922 V2	V2.00

Contents

Preface.....	i
Regulatory Notices.....	v
Caution	vi
Installation Considerations.....	vii
Firmware and Software Compatibility.....	viii
Chapter 1 Introduction	1
1.1 Packing List.....	2
1.2 Options.....	3
1.3 Serial Number / MAC Address.....	4
1.4 Rear View.....	5
1.4.1 1911 / 1912 Models.....	5
1.4.2 1921 / 1922 / 1922 V2 Models.....	6
1.5 Installation	7
Chapter 2 Connecting GV-AS Controller	9
2.1 Connecting through Wiegand Interface.....	9
2.1.1 Physical Connection.....	9
2.1.2 Web Configuration	10
2.2 Connecting through RS-485 Interface	11
2.2.1 Physical Connection.....	11
2.2.2 Web Configuration	12
2.3 Connecting through TCP/IP Interface	13
2.3.1 Physical Connection.....	13
2.3.2 Accessing the Web Interface.....	14
2.3.3 Web Configuration	15
Chapter 3 Fingerprint Only Mode.....	18
3.1 Enrolling Fingerprints.....	18
3.1.1 Enrolling Fingerprints Locally	19
3.1.2 Enrolling Fingerprints Remotely (GV-GF1921 / 1922 / 1922 V2 Only)	22

3.2	Uploading Fingerprints to Readers	26
3.3	Uploading Fingerprints Using Door Groups	30
3.4	Using the Fingerprint Reader.....	31
Chapter 4 Card + Fingerprint Mode.....		32
4.1	Enrollment	32
4.2	Deletion	35
4.3	Using the Fingerprint Reader.....	36
Chapter 5 Card Only Mode.....		37
5.1	Enrollment	38
5.2	Deletion	39
5.3	Using the Fingerprint Reader.....	39
Chapter 6 Standalone Mode		40
6.1	Physical Connection	40
6.2	Enabling the Local Mode	42
6.3	Fingerprints and Card Enrollment.....	43
6.3.1	Fingerprint Only Mode.....	43
Chapter 7 Web Interface for GV-GF1921 / 1922 / 1922		
V2		44
7.1	Network Settings	44
7.2	Card Settings.....	46
7.3	Other Settings	47
7.4	Firmware	50
7.5	Account Settings	51
Chapter 8 Upgrading Firmware		52
8.1	GV-GF1911 / 1912	52
8.1.1	Connecting to a Computer	52
8.1.2	Installing Software.....	54
8.2	GV-GF1921 / 1922 / 1922 V2	56
8.2.1	Through the Utility	56

Chapter 9 LED Indicator	57
9.1 GV-GF1911 / 1912 / 1921 / 1922 / 1922 V2 (connected with GV-AS Manager).....	57
9.2 GV-GF1921 / 1922 / 1922 V2 (Standalone).....	59
Appendix	60

Regulatory Notices



FCC Notice

This equipment has been tested and found to comply with the limits for a Class A digital device, pursuant to part 15 of the FCC Rules. These limits are designed to provide reasonable protection against harmful interference when the equipment is operated in a commercial environment.

Class A

This equipment generates, uses, and can radiate radio frequency energy and, if not installed and used in accordance with the instruction manual, may cause harmful interference to radio communications. Operation of this equipment in a residential area is likely to cause harmful interference in which case the user will be required to correct the interference at their own expense.



CE Notice

This is a Class A product. In a domestic environment, this product may cause radio interference in which case the user may be required to take adequate measures.

RoHS RoHS Compliance

The Restriction of Hazardous Substances (RoHS) Directive is to forbid the use of hazardous materials of production. To meet the RoHS Directive requirements, this product is made to be RoHS compliant.



WEEE Compliance

This product is subject to the Waste Electrical and Electronic Equipment (WEEE) Directive and made compliant with the WEEE requirements.

Caution

- The fingerprint reader is designed only for indoor usage. Avoid exposing to sunshine or rains.
- To keep the fingerprint reader in good working condition, it is recommended to have regular maintenance and physical cleaning of the reader.

Installation Considerations

Note the distance limitations for Wiegand and RS-485 communications:

- Wiegand interface: 30 meters (98.43 feet)
- RS-485 interface: 600 meters (1968.50 feet)

Recommended RS-485 cable: standard 485 cable (a twisted pair of 24 AWG wires)

Firmware and Software Compatibility

Compatible SW and HW	GV-GF1911 / 1912
GV-ASManager	V4.0 or later
GV-AS100 / 110 / 120	V1.06 or later
GV-AS400	V1.04 or later
GV-AS21 / 81 Series	V1.0 or later
GV-AS41 Series	V1.1 or later
GV-EV48	V1.0 or later

Compatible SW and HW	GV-GF1921 / 1922
GV-ASManager	V4.0 or later
GV-AS100 / 110 / 120	N/A
GV-AS400	N/A
GV-AS1010 / GV-EV48	V1.00 or later
GV-AS1620	V1.00 or later
GV-AS210 / 410 / 810	V1.1 or later
GV-AS2110 / 4110 / 8110	V1.23 or later
GV-AS2120	V1.41 or later
GV-CS1320	V2.00 or later

Compatible SW and HW	GV-GF1922 V2
GV-ASManager	V6.1.0 or later
GV-AS100 / 110 / 120	N/A
GV-AS400	N/A
GV-AS1010 / GV-EV48	V1.00 or later
GV-AS1620	V1.00 or later
GV-AS210 / 410 / 810	V1.1 or later
GV-AS2110 / 4110 / 8110	V1.23 or later
GV-AS2120	V1.41 or later
GV-CS1320	V2.00 or later

IMPORTANT: RS-485 connection support for GV-GF1911 / 1912 has been removed from GV-AS21 / 41 / 81 series firmware V1.41, GV-EV48 firmware V2.30 and GV-ASManager V4.4.3.0.

Chapter 1 Introduction

The fingerprint reader can work with GeoVision access controllers and GV-ASManager software to create a complete access control system. Three types of operation modes are supported: Card + Fingerprint, Fingerprint Only, and Card Only.

Card + Fingerprint Mode

With the fingerprint reader only, you can enroll and manage users using the supplied Manager Enroll Card and Delete Card, along with optional MIFARE cards.

The fingerprint templates are stored in the user card. The user gains access by scanning both his/her finger and the card. The reader compares the presented finger with digital template stored in the card. When the finger is successfully authenticated, a signal is sent to activate the door relay of the controller.

Fingerprint Only Mode

The fingerprints are enrolled through a fingerprint reader installed on the GV-ASManager server via RS-485 or a USB cable, or through a fingerprint reader via network. The fingerprints are then distributed through GV-ASManager to the fingerprint readers installed on GeoVision access controllers.

Card Only Mode

The mode requires users to present their cards only to be granted access.

Note: [GV-GF1921 / 1922 / 1922 V2](#) can also work as a standalone device. For details, see [Chapter 6 Standalone Mode](#).

1.1 Packing List

If any of the items are missing or damaged, contact your dealer to arrange a replacement.

GV-GF1911 / 1912



- Fingerprint reader
- Data Cable (of 100 cm / 3.28 feet)
- Manager Enroll Card
- Manager Delete Card
- Self-Tapping Screw (M3 x 6L) x 2
- Self-Tapping Screw (M4 x 15L) x 3
- Plastic Screw Anchor x 4
- Buzzer Hole Plate
- Security Torx
- Software CD

GV-GF1921 / 1922 / GV-GF1922 V2

- Fingerprint reader
- Data Cable (of 30 cm / 0.98 feet)
- Manager Enroll Card
- Manager Delete Card
- Mounting Plate
- Standard Screw x 2
- Plastic Screw Anchor x 2
- Security Screw
- Torx Wrench
- Warranty Card

1.2 Options

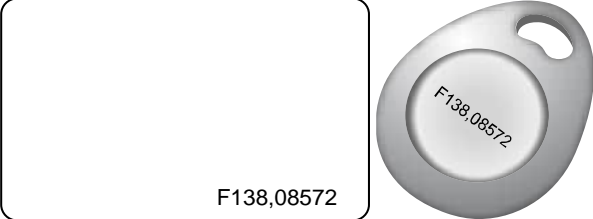
You can order the following optional accessories:

<p>GV-AS ID Card & GV-AS ID Tag</p>	<p>The GV-AS ID F Card / Tag is required. You can find the serial number Fxxx,xxxxx at the bottom right corner of the card, or at the center of the tag.</p> 
<p>GV-NET I/O Card V3.2</p>	<p>The GV-NET I/O Card is an RS-485 to RS-232 interface converter with 4 inputs and 4 relay outputs. You can use the GV-NET I/O Card to connect the fingerprint reader to your computer.</p> 
<p>PC Service Package</p>	<p>The package includes a USB cable for connecting the fingerprint reader to a computer and a reader mount to hold the reader for fingerprint enrollment. See <i>Chapter 8 Upgrading Firmware</i>.</p> 
<p>Note:</p> <ol style="list-style-type: none"> 1. For Card + Fingerprint Mode, GV-GF Fingerprint Readers can only work with GeoVision's user cards and tags. 2. For Card + Fingerprint Mode, be sure that your user card has the serial number starting with the letter F; otherwise, you cannot record fingerprints to the user card. 3. GV-NET I/O Card and PC Service Package are only compatible with GV-GF1911 / 1912. 	

1.3 Serial Number / MAC Address

To find the serial number of **GV-GF1911 / 1912**, see the **XID** number on the back of the reader.



Figure 1-1

For **GV-GF1921 /1922 / GV-GF1922 V2**, you can find the **MAC** address on the back of the reader.



Figure 1-2

1.4 Rear View

1.4.1 1911 / 1912 Models

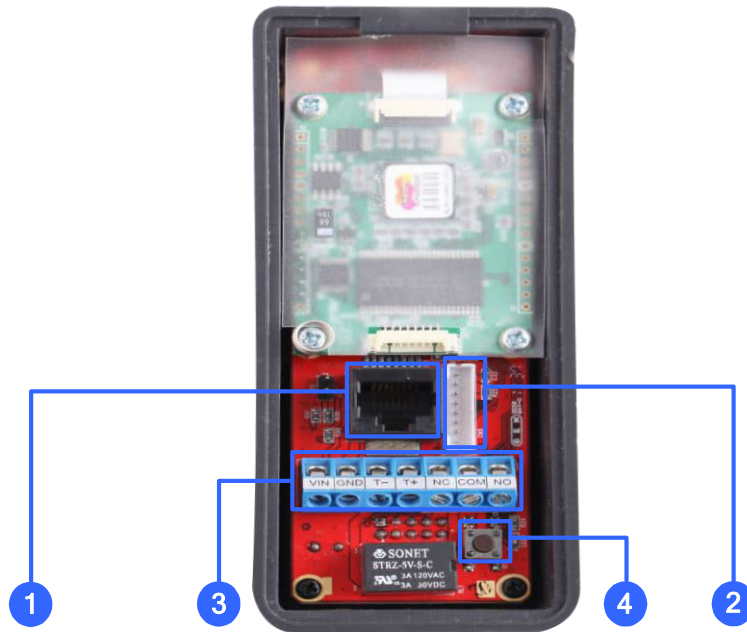

Figure 1-3

No.	Name	Function
1	Ethernet Port	Connects to network and allows network connection with a GV-AS Controller. See 2.3 <i>Connecting through TCP/IP Interface</i> .
2	Wiegand Interface	Connects to a GV-AS Controller through Wiegand connection using the supplied data cable. See 2.1.1 <i>Physical Connection</i> .
	Firmware Upgrade Port	Upgrades firmware with an optional USB cable. See <i>PC Service Package, 1.2 Options</i> .
3	RS-485 Interface	Connects to a GV-AS Controller through RS-485 connection. See 2.2 <i>Connecting through RS-485 Interface</i> .
4	Default Button	Resets all configurations to factory defaults. Press the default button until the steady blue LED light flashes green and red. When you hear the blinking sound, release the default button and the light will turn a steady blue, indicating that the device has been reset to its factory defaults.

1.4.2 1921 / 1922 / 1922 V2 Models

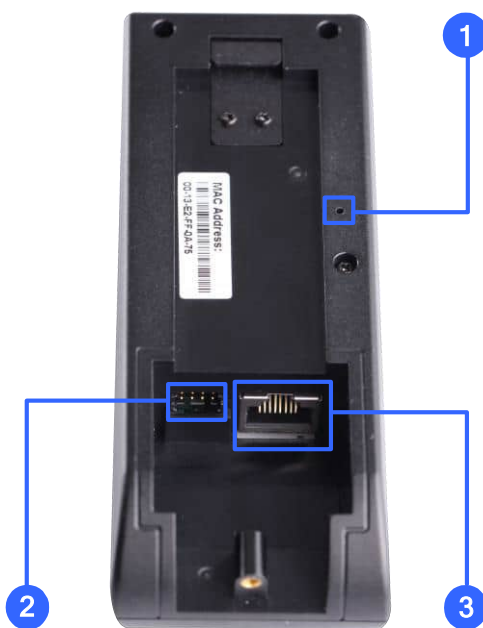

Figure 1-4

No.	Name	Function
1	Default Button	Resets all configurations to factory defaults. Use a pin to press the default button until the steady purple LED light flashes red and blue. When you hear the blinking sound, release the default button and the light will turn a steady purple, indicating that the device has been reset to its factory defaults.
2	I/O Interface	Connects the input and output devices in Local Mode with the supplied data cable. See 6.1 <i>Physical Connection</i> .
3	Ethernet Port	Connects to network and allows network connection with a GV-AS Controller. See 2.3 <i>Connecting through TCP/IP Interface</i> .

1.5 Installation

Follow the steps below to install the GV-GF1921 / 1922 / 1922 V2 reader on the wall.

1. Place the mounting plate on the wall as illustrated below.

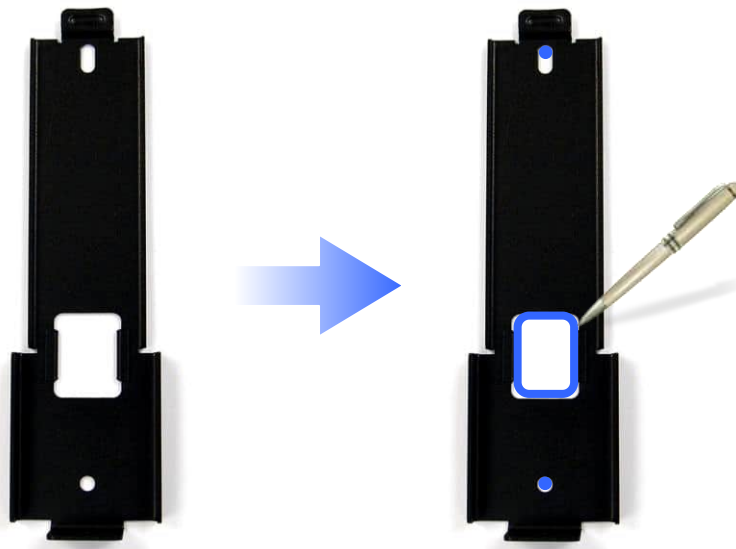

Figure 1-5

2. Mark the location of the 2 holes and the rectangle as labeled above.
3. Drill the rectangle to create a space for running the cables and wires.
4. At the 2 dots, drill a hole slightly smaller than the plastic screw anchors provided.
5. Insert the 2 plastic screw anchors in the drilled holes.
6. Place the mounting plate on the wall and secure with the 2 standard screws provided.



Figure 1-6

7. Place fingerprint reader on the mounting plate and thread the cables through the rectangular hole.



Figure 1-7

8. Secure the security screw on the bottom.



Figure 1-8

Chapter 2 Connecting GV-AS Controller

Depending on the model of the fingerprint reader, three types of communication links are available: **Wiegand**, **RS-485** and **TCP/IP**.

2.1 Connecting through Wiegand Interface

Supported models: **GV-GF1911 / 1912**.

2.1.1 Physical Connection

The fingerprint reader is connected with an unshielded 9-wire cable of 100 cm / 3.28 feet. Connect these 4 unshielded wires to the assigned pins on the Wiegand interface of the GV-AS Controller: Red, Black, White and Green wires.

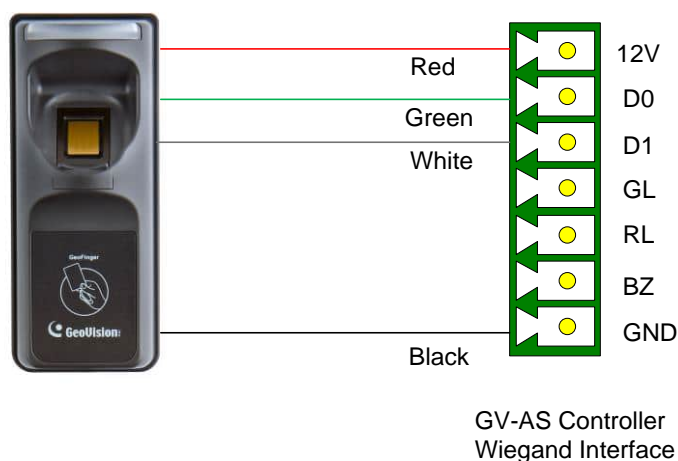

Figure 2-1

The table below shows the wire assignments of the fingerprint reader used for Wiegand connection.

Wire	Red	Black	White	Green	Yellow	Blue	Orange	Brown	Silver
Function	12V	GND	Data-1	Data-0	N/C	N/C	N/C	N/C	N/C

For the wiring of extending distance it is recommended to use the standard RS-485 cable (a twisted pair of 24 AWG wires). The maximum distance of the Wiegand output cable should be restricted to a length of 30 meters (98.43 feet).

2.1.2 Web Configuration

To define the fingerprint reader connected to the GV-AS Controller. On the Web interface of GV-AS Controller, click **Wiegand Setting** in the left menu. The Wiegand Configuration page appears. Select the function, e.g. Door/Gate 1 Entry, that the fingerprint reader is used for, and click **Submit**.

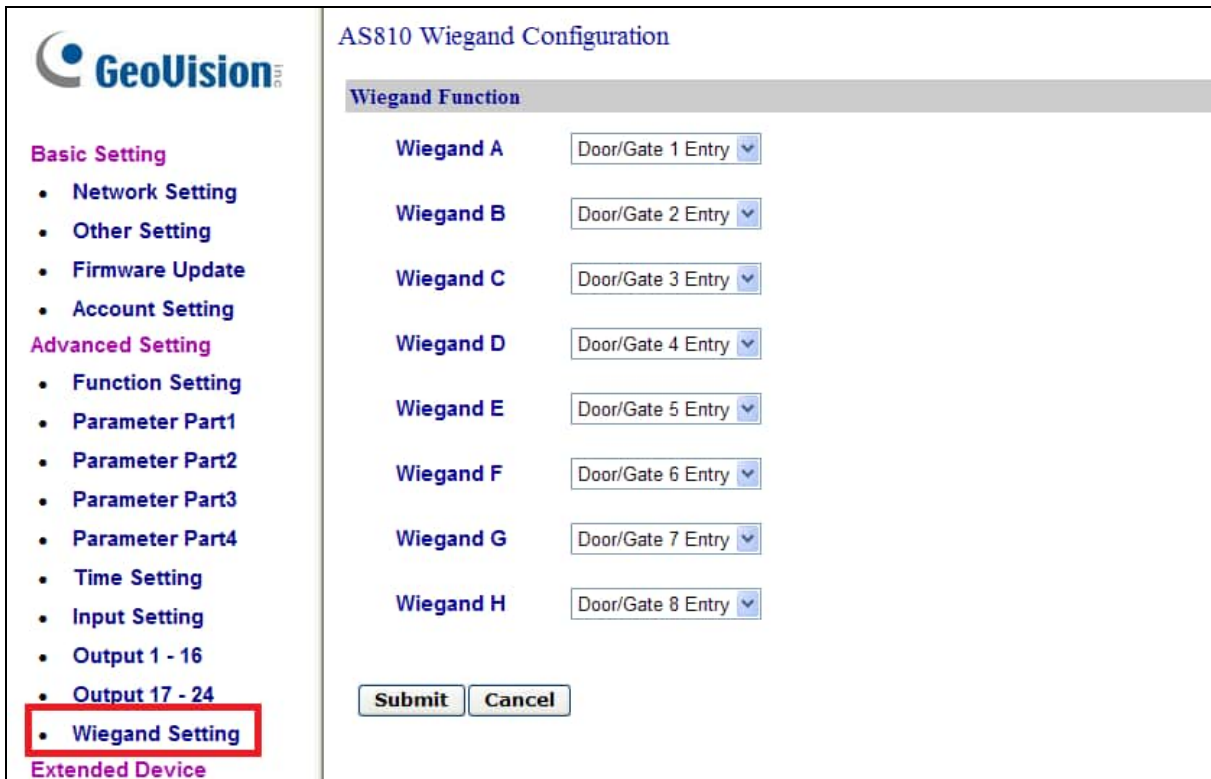

AS810 Wiegand Configuration	
Wiegand Function	
Wiegand A	Door/Gate 1 Entry
Wiegand B	Door/Gate 2 Entry
Wiegand C	Door/Gate 3 Entry
Wiegand D	Door/Gate 4 Entry
Wiegand E	Door/Gate 5 Entry
Wiegand F	Door/Gate 6 Entry
Wiegand G	Door/Gate 7 Entry
Wiegand H	Door/Gate 8 Entry

Figure 2-2

2.2 Connecting through RS-485 Interface

Supported models: **GV-GF1911 / 1912.**

Note: RS-485 connection support for GV-GF1911 / 1912 has been removed from GV-AS21 / 41 / 81 series firmware V1.41, GV-EV48 firmware V2.30 and GV-ASManager V4.4.3.0.

2.2.1 Physical Connection

Use the terminal block on the above four reader models for RS-485 connection to the GV-AS Controller.

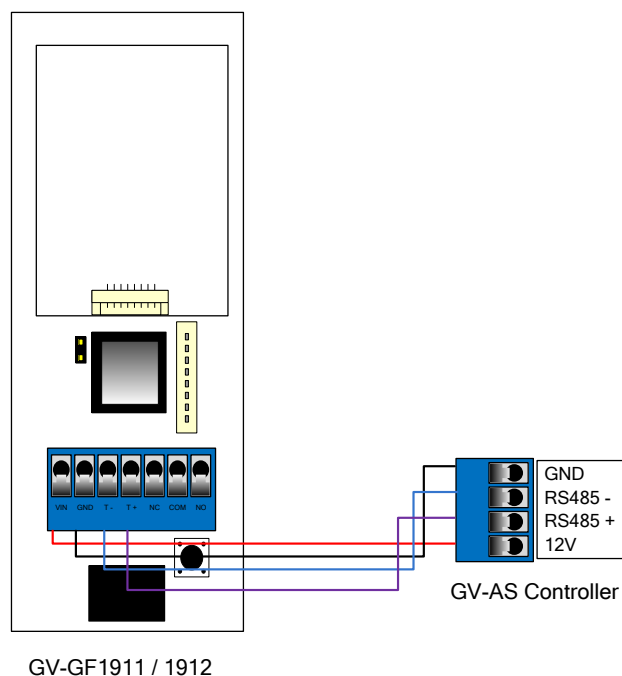

Figure 2-3

The table below shows the pin assignments of the fingerprint reader used for RS-485 connection.

Pin	VIN	GND	T-	T+
Function	12V	GND	RS-485 -	RS-485 +

2.2.2 Web Configuration

To define the fingerprint reader connected to the GV-AS Controller, on the Web interface of GV-AS Controller, click **Extended Reader** in the left menu. The Extended Reader Configuration page appears.

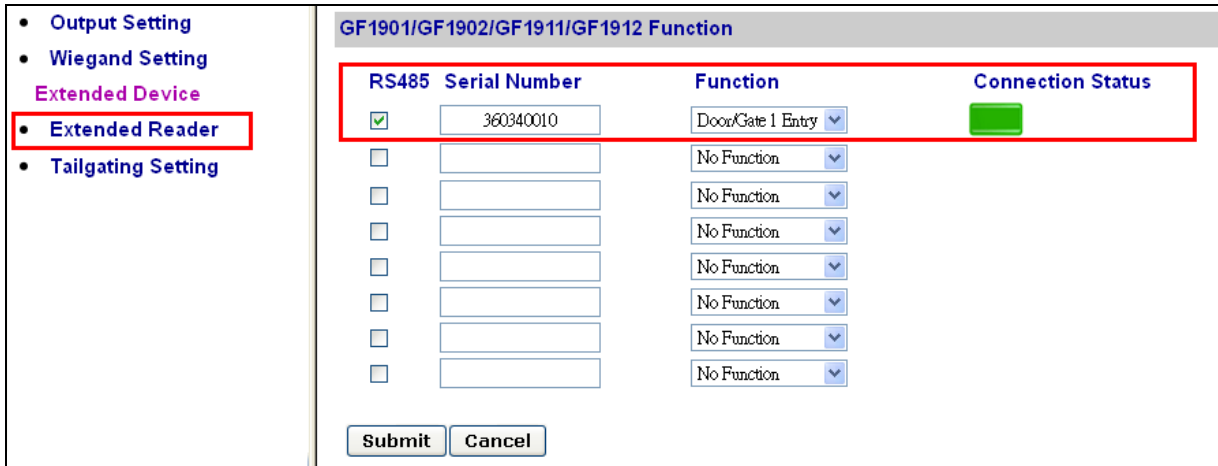

GF1901/GF1902/GF1911/GF1912 Function			
RS485	Serial Number	Function	Connection Status
<input checked="" type="checkbox"/>	360340010	Door/Gate 1 Entry	
<input type="checkbox"/>		No Function	
<input type="checkbox"/>		No Function	
<input type="checkbox"/>		No Function	
<input type="checkbox"/>		No Function	
<input type="checkbox"/>		No Function	
<input type="checkbox"/>		No Function	
<input type="checkbox"/>		No Function	

Figure 2-4

Type **Serial Number** of your fingerprint reader (See 1.3 Serial Number / MAC Address), and select **Function** that the fingerprint reader is used for, and click **Submit**. If the fingerprint reader is detected, the **Connection Status** field will be green.

IMPORTANT: For RS-485 connection, make sure to check the **RS485** box before the serial number to establish connection.

2.3 Connecting through TCP/IP Interface

Supported models: **GV-GF1911 / 1912 / 1921 / 1922 / 1922 V2**

2.3.1 Physical Connection

The fingerprint reader and GV-AS Controller can be connected through LAN. Prepare a 12V DC power adapter to connect the fingerprint reader to a power source.

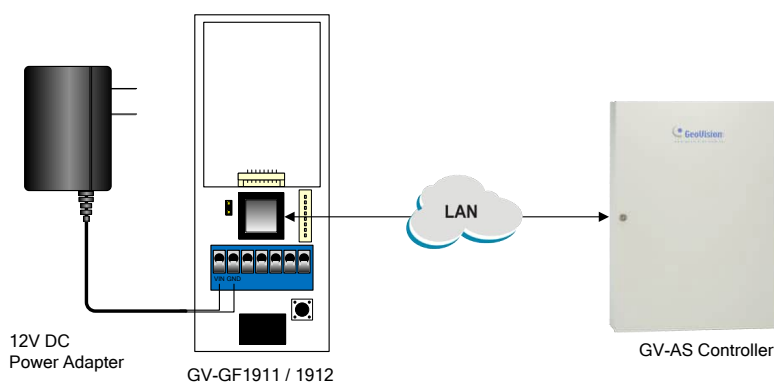

Figure 2-5

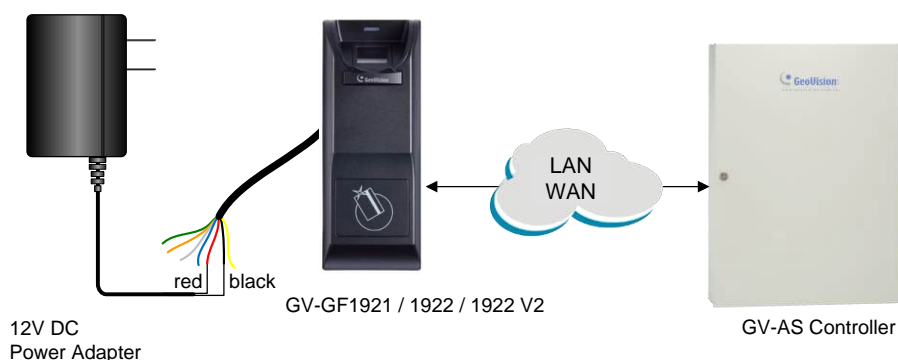

Figure 2-6

The table below shows the pin assignments of the fingerprint reader used for power connection.

Pin	GV-GF1911 / 1912	VIN	GND
	GV-GF1921 / 1922 / 1922 V2	Red wire	Black wire
Function		12V	GND

Note: You can also connect the fingerprint reader to GV-AS Controller for power supply instead of using the 12V DC power adapter.

2.3.2 Accessing the Web Interface

When the fingerprint reader connects to a network, the DHCP server automatically assigns it an unused IP address. This IP address will remain unchanged unless you unplug or disconnect your reader from the network.

Note: If your router does not support DHCP, the default IP address is **192.168.0.10**. The default login ID and password are both **admin**.

Follow the steps below to look up the IP address of your fingerprint reader and access its Web interface:

1. Make sure the PC used to configure the IP address is under the same LAN as the reader. Download and install **GV-IP Device Utility** from the company [website](#).
2. On the GV-IP Utility window, click the  button to search for IP devices connected to the same LAN. Click the **Name** or **Mac Address** column to sort.
3. Find the reader with its Mac Address.

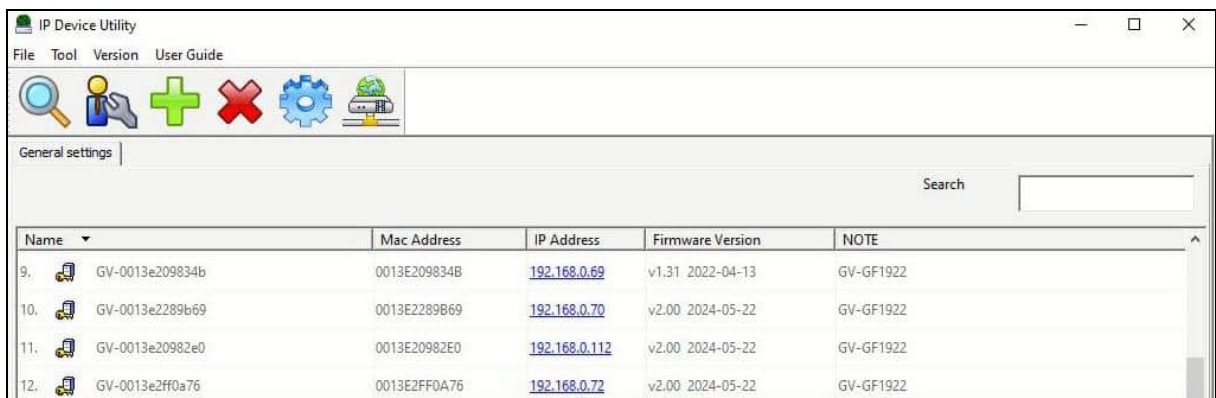

The screenshot shows the 'IP Device Utility' application window. It has a menu bar with 'File', 'Tool', 'Version', and 'User Guide'. Below the menu is a toolbar with icons for search, add, delete, settings, and refresh. The main area is titled 'General settings' and contains a search box. Below the search box is a table with the following data:

Name	Mac Address	IP Address	Firmware Version	NOTE
9. GV-0013e209834b	0013E209834B	192.168.0.69	v1.31 2022-04-13	GV-GF1922
10. GV-0013e2289b69	0013E2289B69	192.168.0.70	v2.00 2024-05-22	GV-GF1922
11. GV-0013e20982e0	0013E20982E0	192.168.0.112	v2.00 2024-05-22	GV-GF1922
12. GV-0013e2ff0a76	0013E2FF0A76	192.168.0.72	v2.00 2024-05-22	GV-GF1922

Figure 2-7

4. Click on its IP address and select **Web Page** to access its Web interface.
5. Type the default ID and password (admin / admin) and click **Login**.

IMPORTANT: The reader's Web interface must be accessed using IE mode of Microsoft Edge. If you cannot access the Web interface, see [Appendix](#) for detailed instructions.

2.3.3 Web Configuration

To connect the fingerprint reader and GV-AS Controller via network, you need to provide information such as a serial number, MAC address and IP address for your fingerprint reader and GV-AS Controller to locate and connect to each other.

A. Define Fingerprint Reader on GV-AS Controller

1. Log in the Web interface of GV-AS Controller.
2. Click **Extended Reader** in the left menu. The Extended Reader Configuration page appears.
3. To define a reader on GV-AS Controller:

[GV-GF1921 / 1922 / 1922 V2]

Type the **MAC address** of your fingerprint reader in the Serial Number column under **GV-Reader/CR420/GF1921/GF1922 Function**. Do not select the RS-485 box.

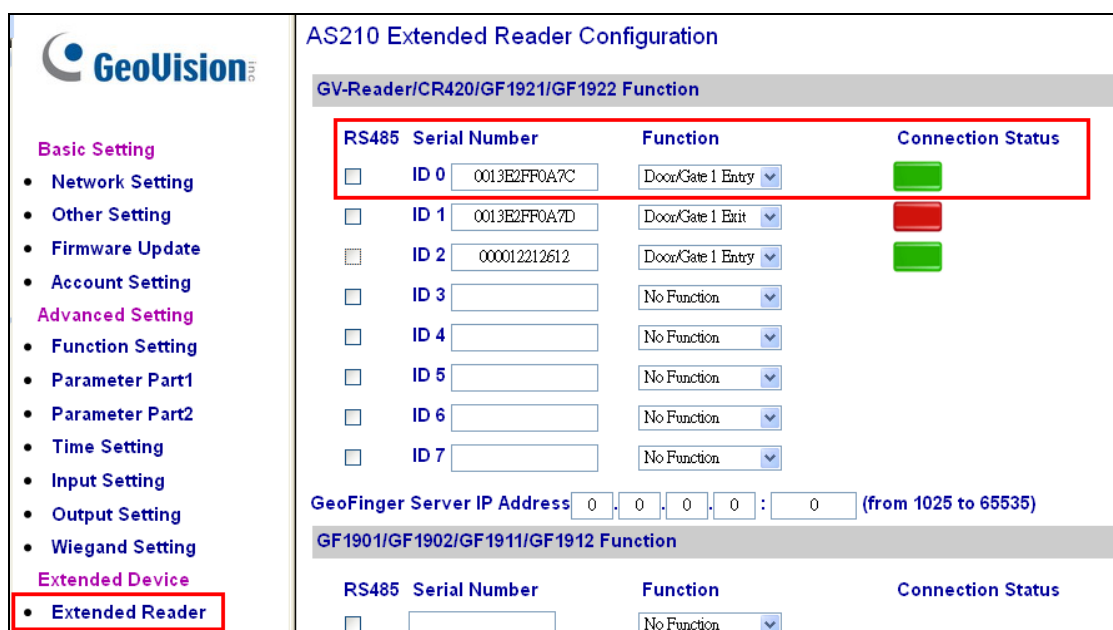
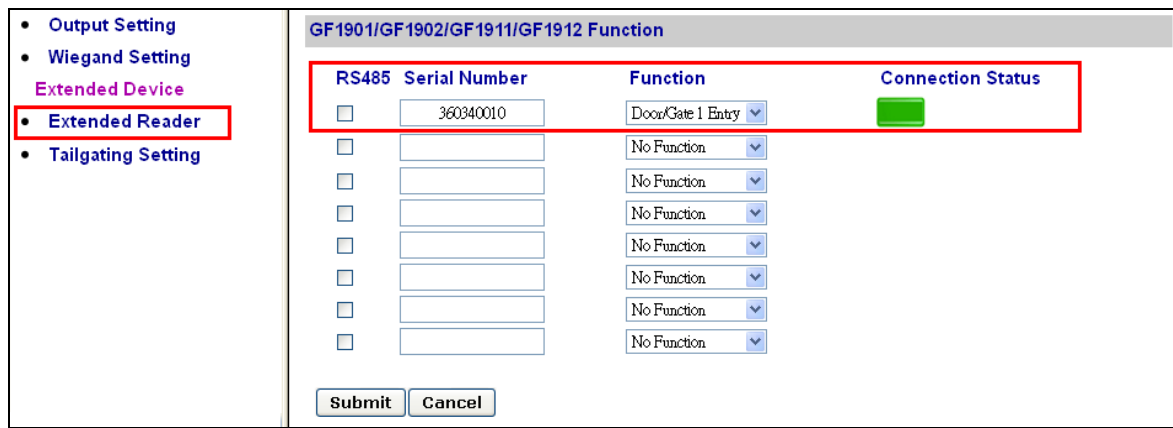

Figure 2-8

For **GeoFinger Server IP Address**, type the GV-ASManager's IP address and port to allow it to receive data from the fingerprint reader listed on this page for remote fingerprint enrollment. In addition, GV-AS Controller will also be connected to the fingerprint reader listed. You can therefore skip the steps in *B. Specify GV-AS Controller on Fingerprint Reader* if you fill in the GeoFinger Server IP Address on this page.

[GV-GF1911 / 1912]

Type the **Serial Number** of your fingerprint reader in the Serial Number column under the **GF1901/GF1902/GF1911/GF1912 Function** section.



RS485	Serial Number	Function	Connection Status
<input checked="" type="checkbox"/>	360340010	Door/Gate 1 Entry	
<input type="checkbox"/>		No Function	
<input type="checkbox"/>		No Function	
<input type="checkbox"/>		No Function	
<input type="checkbox"/>		No Function	
<input type="checkbox"/>		No Function	
<input type="checkbox"/>		No Function	
<input type="checkbox"/>		No Function	

Figure 2-9

Note: Select the **RS-485** checkbox only if the GV-GF1911 / 1912 is connected to the controller through RS-485 connection. For TCP/IP connection, do not check the **RS485** box.

For details on how to look up the serial number or the MAC address, see *1.3 Serial Number / MAC Address*.

- Use the **Function** drop-down list to specify which door the fingerprint reader is connected to.
- Click **Submit**. When the fingerprint reader is detected, a green bar appears under the **Connection Status**.

B. Specify GV-AS Controller on Fingerprint Reader

6. Log in the Web interface of the fingerprint reader. For details, see 2.3.2 *Accessing the Web Interface*.
7. To specify a GV-AS Controller on the reader:

[GV-GF1911 / 1912]

Click **SETTINGS** and select **GV-AS Controller**. On this page, type the GV-AS Controller’s IP address and click **Save**.

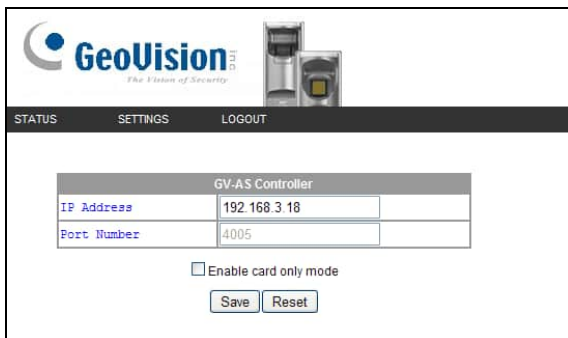

Figure 2-10

[GV-GF1921 / 1922 / 1922 V2]

Select **Other Settings**. On this page, type the GV-AS Controller’s IP address or domain name and click **Submit**.

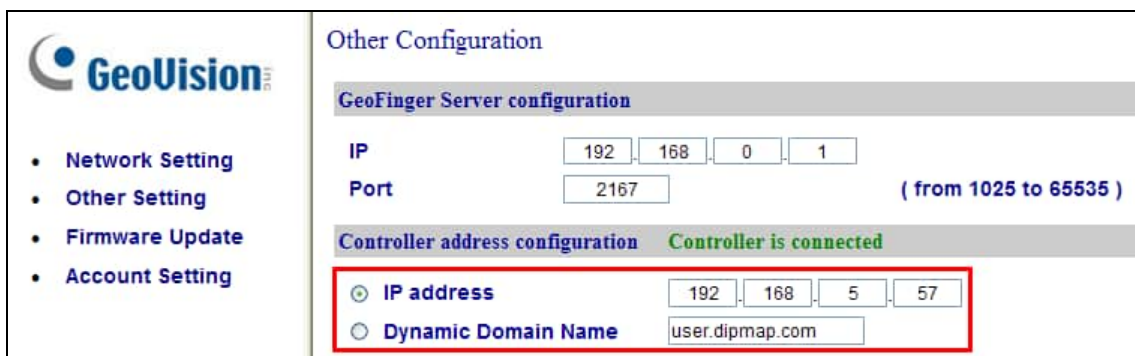

Figure 2-11

When the connection is established, the message “Controller is connected” appears.

Note: If the fingerprint reader fails to connect to GV-AS Controller, it beeps (for GV-GF1911 / 1912) or the light turns purple (for GV-GF1921 / 1922 / 1922 V2) until the connection is established.

Chapter 3 Fingerprint Only Mode

The Fingerprint Only mode must be used in conjunction with the GV-ASManager software and the GV-GF1911 / 1921 / 1922 / 1922 V2 reader to enroll fingerprints. You first enroll fingerprint data in GV-ASManager before uploading it to the fingerprint readers installed on GeoVision access controllers. To get access, the user's fingerprint must match the registered one.

3.1 Enrolling Fingerprints

There are two options for enrolling fingerprints: locally and remotely.

To **enroll fingerprints locally**, connect a GV-GF1911 / 1921 / 1922 / 1922 V2 reader to GV-ASManager and register fingerprints at the GV-ASManager's site.

To **enroll fingerprints remotely**, first enroll blank fingerprints for a user in GV-ASManager. The user can then register fingerprints on a connected GV-GF1921 / 1922 / 1922 V2 reader using a given card. This function is helpful when the user is not at the GV-ASManager's location.

Note: Local fingerprint enrollment at the GV-ASManager's site requires a separate GV-GF1911 / 1921 / 1922 / 1922 V2 reader.

3.1.1 Enrolling Fingerprints Locally

To connect the reader to GV-ASManager:

- **GV-GF1911: RS-485 or USB Connection with GV-ASManager**

Connect GV-GF1911 to the GV-ASManager server via RS-485 or USB connection. To establish a connection, a RS-485 to RS-232 converter, such as GV-HUB, GV-Hub, GV-NET/IO Card, or the USB cable in PC Service Package (optional accessory), is required.

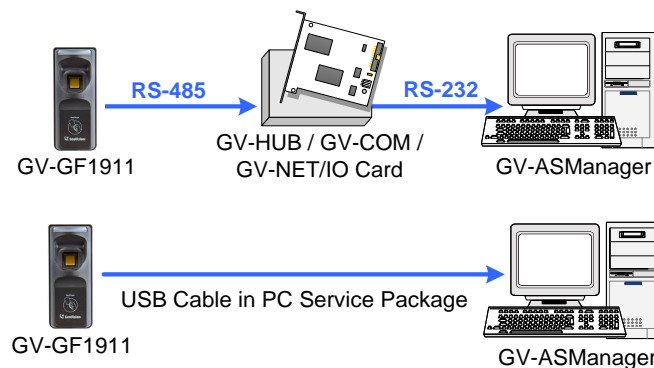

Figure 3-1

- **GV-GF1921 / 1922 / 1922 V2: LAN Connection with GV-ASManager**

Connect GV-ASManager and GV-GF1921 / 1922 / 1922 V2 over LAN.

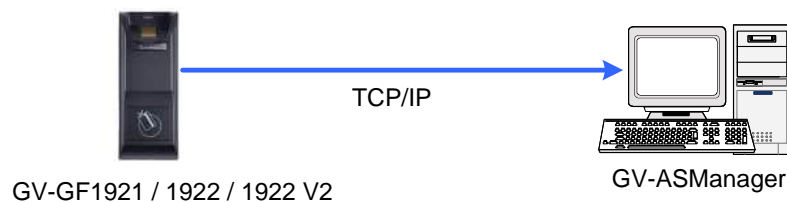

Figure 3-2

Note:

1. Fingerprint enrollment does not support a Wiegand connection.
 2. After connecting the GV-HUB, GV-COM, GV-NET/IO Card or USB cable to the server, install the driver from the supplied software.
 3. RS-485 connection support for GV-GF1911 has been removed from GV-AS21 / 41 / 81 series firmware V1.41 and GV-ASManager V4.4.3.0.
 4. To work with the Fingerprint Only Mode on GV-GF1911, an optionally purchased PC Service Package, which includes a USB cable, is required.
-

Enrolling Fingerprints Locally on GV-ASManager

Before you begin enrolling fingerprints, ensure that you have added cards, created user accounts, and assigned cards to users in GV-ASManager. Follow the steps below to enroll fingerprints on GV-ASManager.

Note: Each user's fingerprints must be paired with a card number. If you do not have cards, you can generate virtual card numbers to represent the enrolled fingerprints.

1. On the menu bar of GV-ASManager, click **Personnel** and select **Users**. The User List window appears.
2. Double-click one user listed in the window. The User Setup dialog box appears.
3. Click the **Features** tab. This dialog box appears.

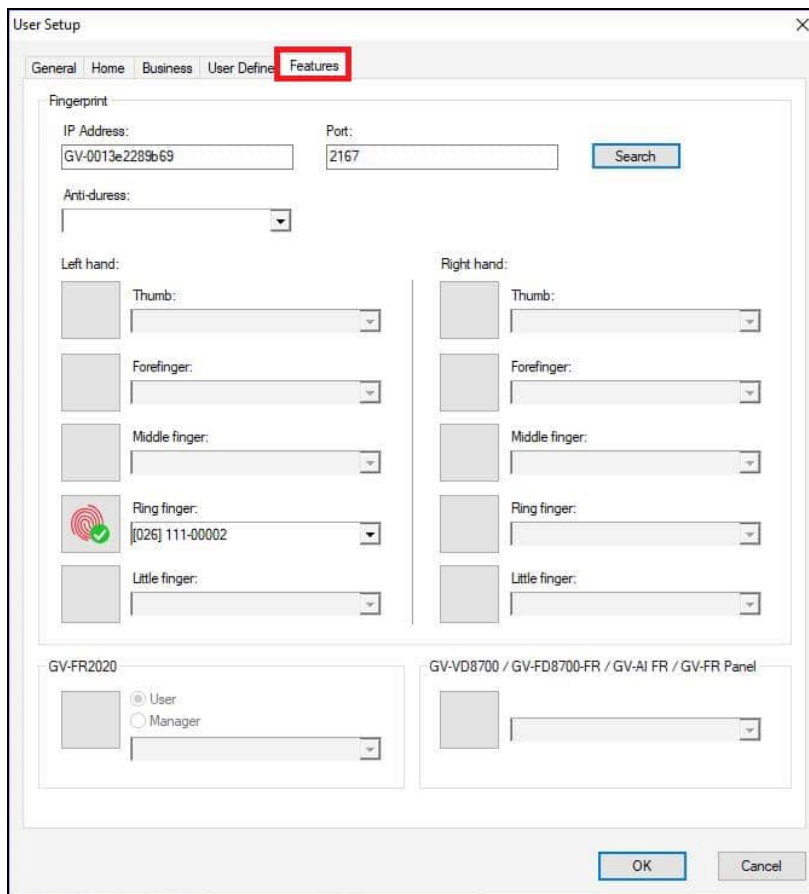

Figure 3-3

3 Fingerprint Only Mode

4. Establish connection between GV-ASManager and the reader.
 - **GV-GF1911:** Select **COM** for Connection Type, and click **Search** to detect the reader.
 - **GV-GF1921 / 1922 / 1922 V2:** Type the reader's **IP Address** and **Port** , or click **Search** to detect the reader under the same LAN.
5. Click a finger square and select **Enroll Fingerprints**.

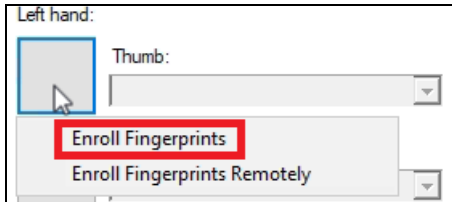

Figure 3-4

6. Place the finger on the reader. It is required to register the same fingerprint **twice** to complete the enrollment. A user's ten fingerprints can be enrolled.
7. Use the drop-down list to assign a card to the enrolled fingerprint.
8. To delete an enrolled fingerprint, place the mouse pointer on the fingerprint image. The **✖** button appears. Click the button to delete the fingerprint.
9. To use the **Anti-duress** function, select a fingerprint from the drop-down list. When the user is threatened and forced to open the door, he/she can use the designated finger to activate an alarm and send a warning message to GV-ASManager.

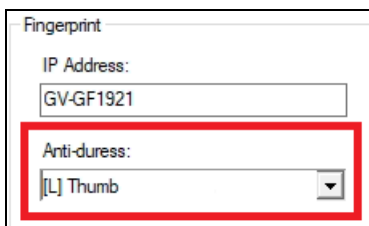

Figure 3-5

10. Click **OK** to apply the settings.
11. To upload the enrolled fingerprints to a connected GV-GF1921 / 1922 / 1922 V2 reader, see *3.2 Uploading Fingerprints to Readers*.

3.1.2 Enrolling Fingerprints Remotely (GV-GF1921 / 1922 / 1922 V2 Only)

Before you begin enrolling fingerprints, ensure that you have added cards, created user accounts, and assigned cards to users in GV-ASManager. Follow the procedures below to remotely enroll fingerprints on a GV-GF1921 / 1922 / 1922 V2 reader.

1. On the menu bar of GV-ASManager, click **Personnel** and select **Users**. The User List window appears.
2. Double-click one user listed in the window. The User Setup dialog box appears.
3. Click the **Features** tab.
4. Click a finger square and select **Enroll Fingerprints Remotely**.

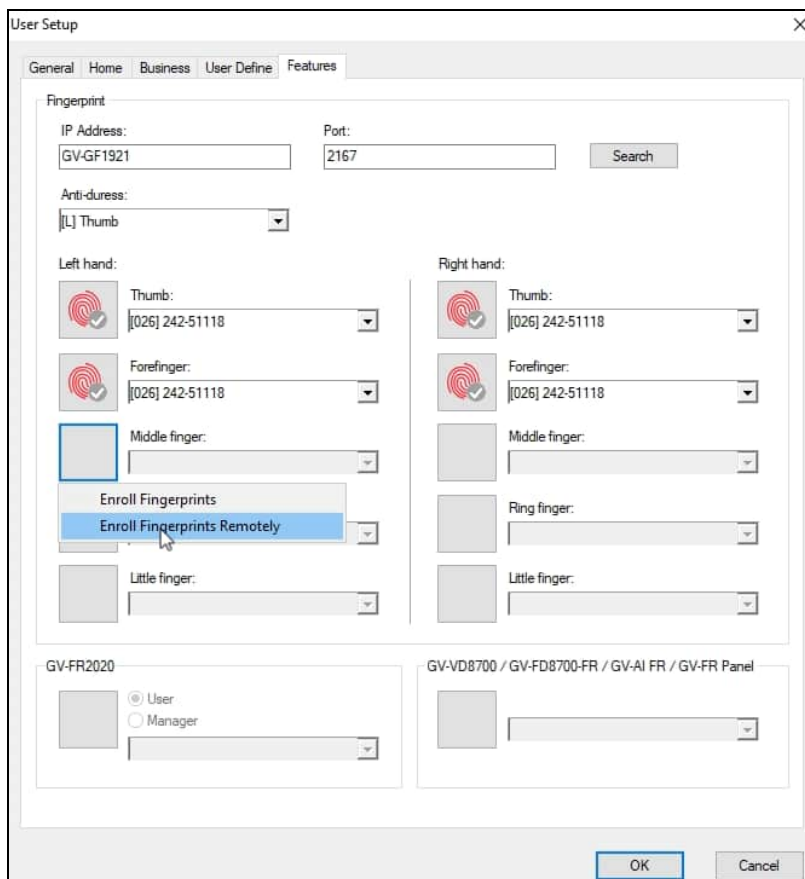



Figure 3-6

5. Use the drop-down list to assign a card to a blank fingerprint.
6. Repeat steps 5 and 6 to create multiple fingerprint data if needed.
7. To delete a blank fingerprint, place the mouse pointer on the finger square. The  button appears. Click the button to delete the fingerprint.
8. To use the **Anti-duress** function, select a finger from the drop-down list. When the user is threatened and forced to open the door, he/she can use the designated finger to activate an alarm and send a warning message to GV-ASManager.

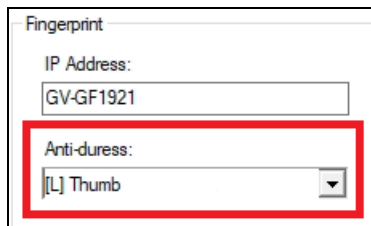
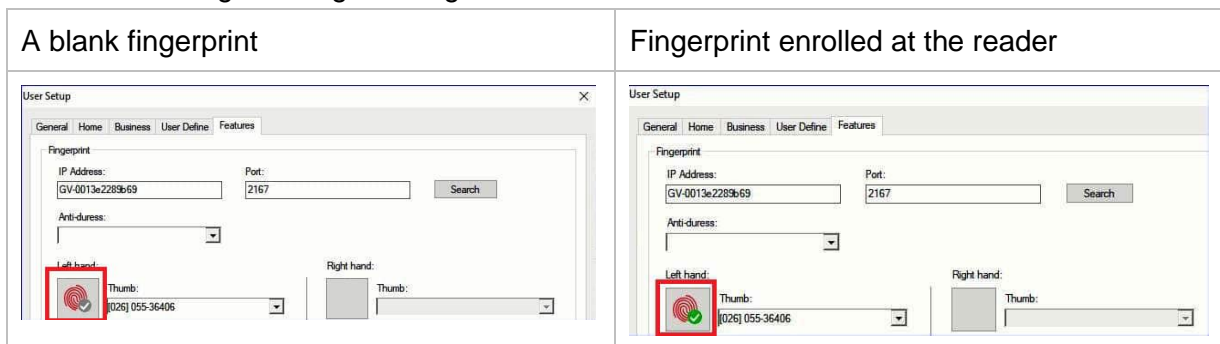

Figure 3-7

9. Click **OK** to apply the settings.
10. To upload the enrolled blank fingerprints to a connected GV-GF1921 / 1922 / 1922 V2 reader, see *3.2 Uploading Fingerprints to Readers*.

The user can then register fingerprints at any time by swiping a given card and using a connected fingerprint reader. To register a fingerprint, see Step 2 ~5, Enrollment Procedures in *4.1 Enrollment*.

After a fingerprint is successfully enrolled at a connected fingerprint reader, the gray tick icon in GV-ASManager changes to a green tick.



If more than one blank fingerprint has been enrolled for a user, have the user register left hand first, followed by right hand, in the order of thumb, forefinger, middle finger, ring finger and little finger, on a connected fingerprint reader. Using Figure 3-6 as an example, register in the order of left hand thumb, then left hand forefinger, and finally right hand thumb and forefinger.

Allowing the Reader to Transfer Data Back to GV-ASManager

To allow the GV-GF1921 / 1922 / 1922 V2 reader to transfer data back to GV-ASManager for **remote fingerprint enrollment**, you must go to the Web interface of the GV-AS Controller or the fingerprint reader to complete the settings below.

Complete setting A **OR** B:

- A. Go to the Web interface of the reader, click **Other Setting** in the left menu, and type the GV-ASManager's **IP** address and **Port** (2167 by default).

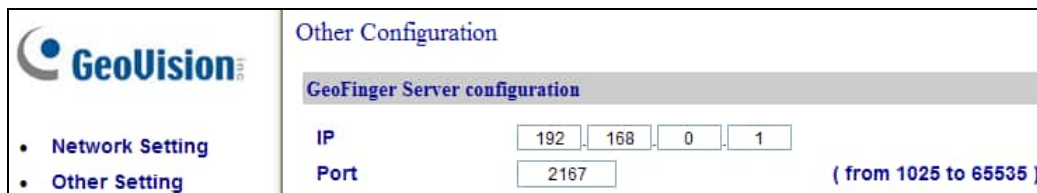

Figure 3-8

- B. Go to the Web interface of GV-AS Controller, click **Extended Reader** in the left menu, the GV-ASManager's **IP** address and **Port** (2167 by default).

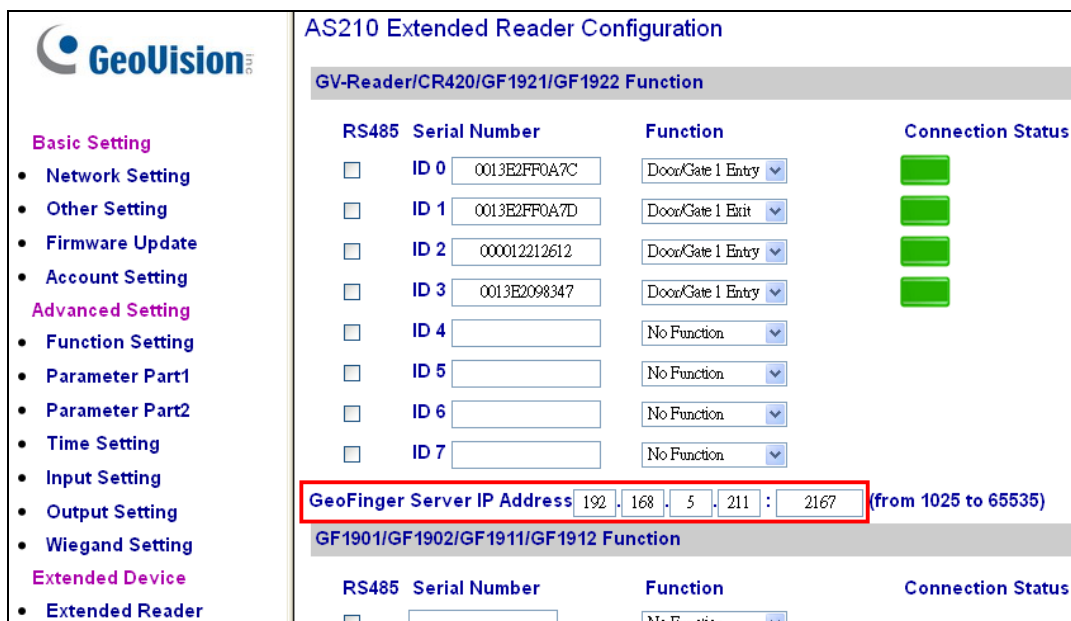

Figure 3-9

Note: The GeoFinger Server IP Address is the GV-ASManager's IP address. To find out the GeoFinger Server port in GV-ASManager, select **Tools > Servers > GeoFinger Server**.

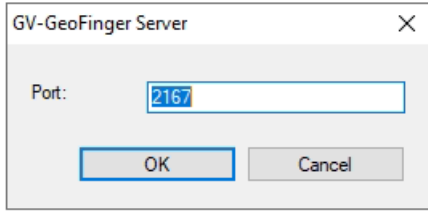

Figure 3-10

3.2 Uploading Fingerprints to Readers

There are two options for uploading enrolled fingerprints from GV-ASManager to fingerprint readers.

For **GV-GF1911 / 1912**, data can be transferred to GV-AS Controller over network and then to GV-GF1911 / 1912 via RS-485. For GV-GF1911, data can also be sent via a USB cable.

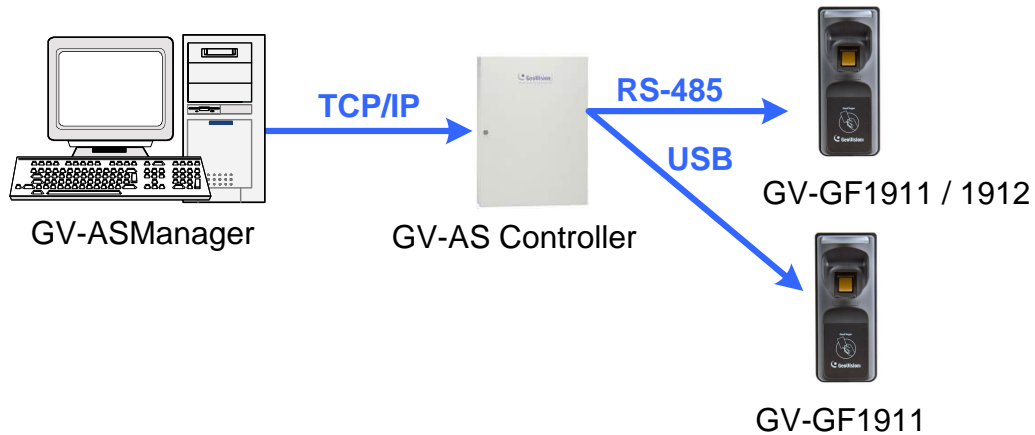

Figure 3-11

For **GV-GF1911 / 1912 / 1921 / 1922 / 1922 V2**, data can be transferred straight from GV-ASManager over network.

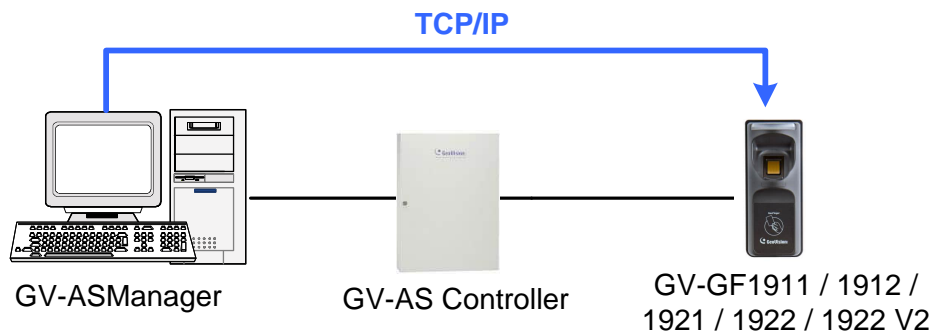

Figure 3-12

Note:

1. RS-485 connection support for GV-GF1911 / 1912 has been removed from GV-AS21 / 41 / 81 series firmware V1.41, GV-EV48 firmware V2.30 and GV-ASManager V4.4.3.0.
 2. To upload fingerprints, an optionally purchased PC Service Package, which includes a USB cable, is required for GV-GF1911.
-

3 Fingerprint Only Mode

To upload data from GV-ASManager to the fingerprint reader, follow the instruction below.

A. Connect GV-ASManager and the Reader

1. On the menu bar of GV-ASManager, click **Setup** and select **Devices**.
2. Double-click a controller and select a **Door**. The Controller Setup dialog box appears.
3. If the reader is connected to GV-AS Controller via RS-485, select **GV-GeoFinger** for **Entrance** or **Exit** under the Extended Reader section, without typing an IP address/MAC address or serial number.

If the reader is connected to GV-AS Controller through TCP/IP, define the fingerprint reader. Select **GV-GeoFinger** for **Entrance** or **Exit** under the Extended Reader section, and type the reader's **IP address** and **port**.

To look up the machine name, see *7.1 Network Settings*.

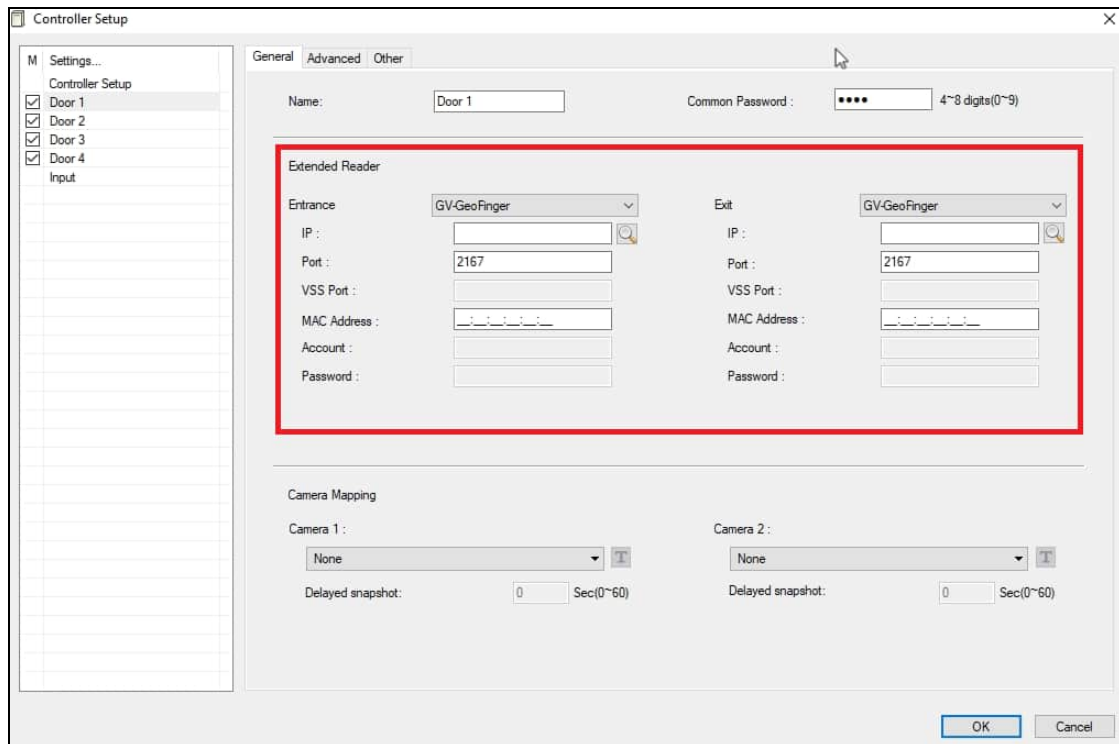

Figure 3-13

B. Upload Fingerprints to the Reader

4. On the menu bar of GV-ASManager, click **Setup** and select **Feature Access**. This dialog box appears.

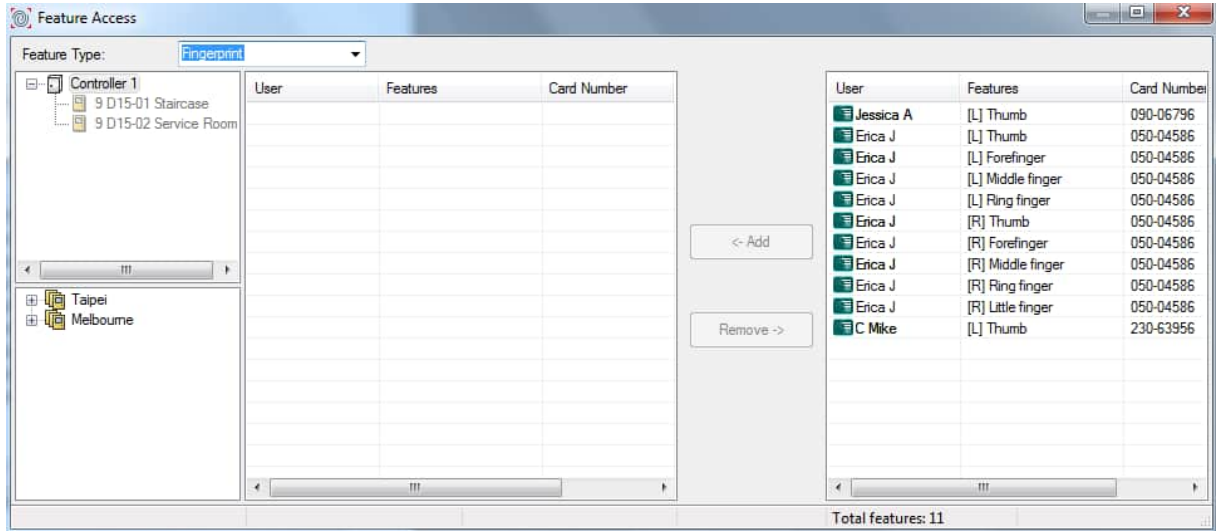

Figure 3-14

5. To upload fingerprints, select the desired doors in the top-left pane. If you have assigned multiple doors to a group, select the desired group in the bottom-left pane.
6. Select the desired fingerprints on the right pane. The **Add** button becomes available.

3 Fingerprint Only Mode

- Click the **Add** button to upload the selected fingerprints to the desired doors or groups. When the upload is complete, check marks will appear in the **In** (Entrance door) or **Out** (Exit door) columns. The resulting window after uploading may look like this:

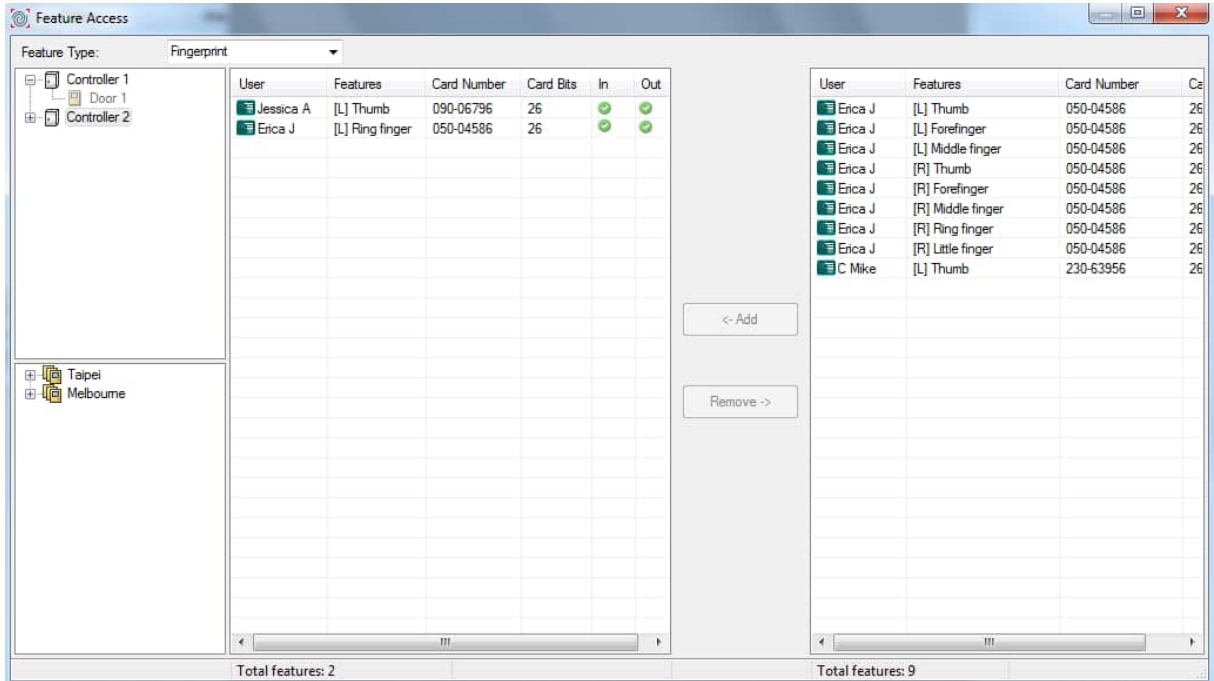

Figure 3-15

Note:

- If green checkmarks are missing in the **In** or **Out** columns, right-click the door in the Controllers View on the main screen, and select **Sync GV-GeoFinger** to re-upload the data.
 - Each fingerprint reader can store up to 1,900 fingerprints. GV-GF1922 V2 can store up to 9,500 fingerprints.
 - For how to create a group, see 3.3 *Uploading Fingerprints Using Door Groups*.
-

3.3 Uploading Fingerprints Using Door Groups

When a large number of GV-AS Controllers are connected to GV-ASManager, the doors of different controllers can be organized into different door groups. Using door groups, you can quickly upload fingerprints to doors installed with fingerprint readers.

1. On the menu bar of GV-ASManager, click **Setup** and select **Door Groups**. This window appears and the connected controllers are listed on the right.

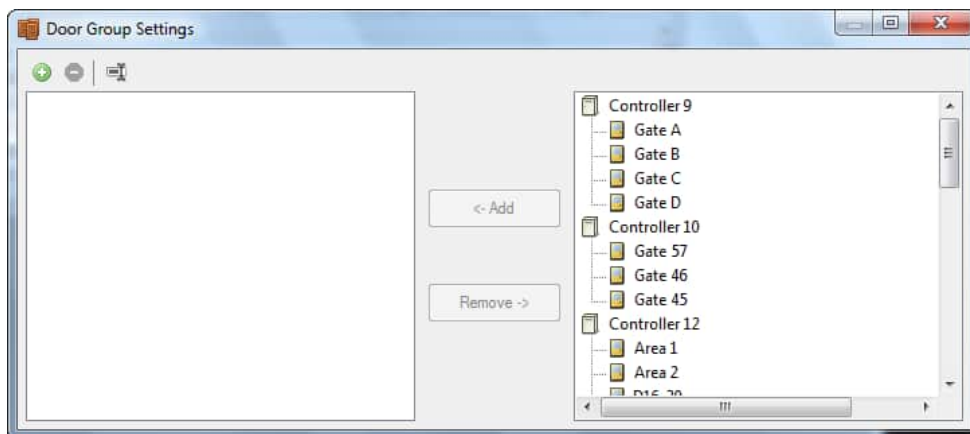



Figure 3-16

2. Click the **Add Group** button . A new group is created.
3. Click the new group and click the **Rename Group** button  to rename the group.
4. Select the desired doors from the right pane to add to the new group.
5. Click the **Add** button. The selected doors are now assigned to the group.

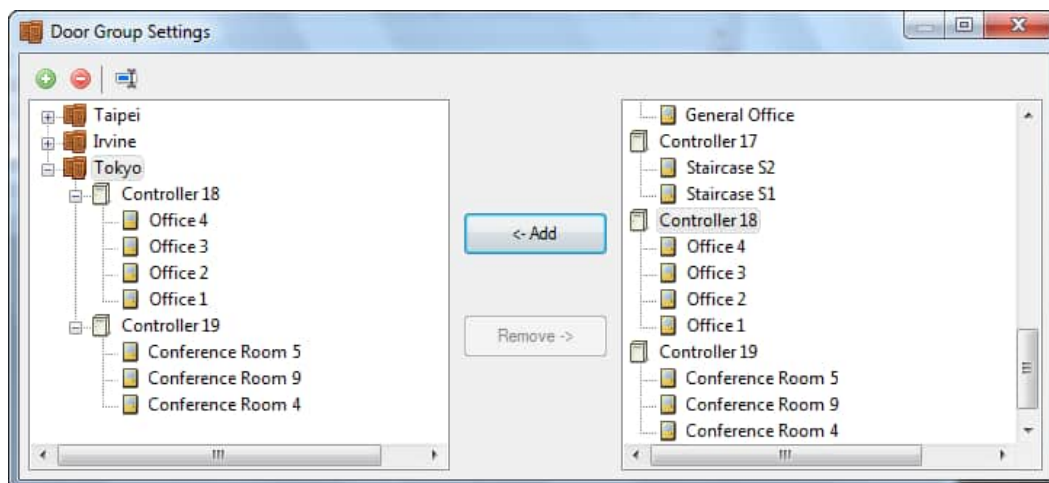

Figure 3-17

6. To add fingerprints to a door group, follow Step 7 in *3.3 Uploading Fingerprints to Readers*.

3.4 Using the Fingerprint Reader

After you connect the fingerprint reader to a controller and enroll fingerprints, scan your enrolled finger to gain access.

1. If the presented fingerprint matches any record in the fingerprint reader, the light will change from blue to green. The access signal will be sent to the controller. Access will be granted.
2. If the presented fingerprint does not match the record in the fingerprint reader, the light will change from steady blue to yellow and the reader will beep three times. Then the light will return to a steady blue. The reader will not send access signal to the controller. Access will be denied.

Note: The light on fingerprint reader turns red if the access does not occur within the GV-ASManager's established schedule.

Chapter 4 Card + Fingerprint Mode

IMPORTANT: In **Card + Fingerprint Mode**,

1. The fingerprint reader can only work with **GV-AS ID F** cards and tags. Each card or tag can only store two fingerprints.
2. It is required to set card identification to **GeoVision Card (UID)** or **GeoVision Card (GID)**. See *7.2 Card Setting*.

4.1 Enrollment

The user's fingerprints are stored in the user card and each user card can store up to two fingerprints. To gain access, a user must scan both the user card and the enrolled finger.



Cards Required for Enrollment

- Manager Enroll Card (supplied in the package)
- User Card

Enrollment Procedures

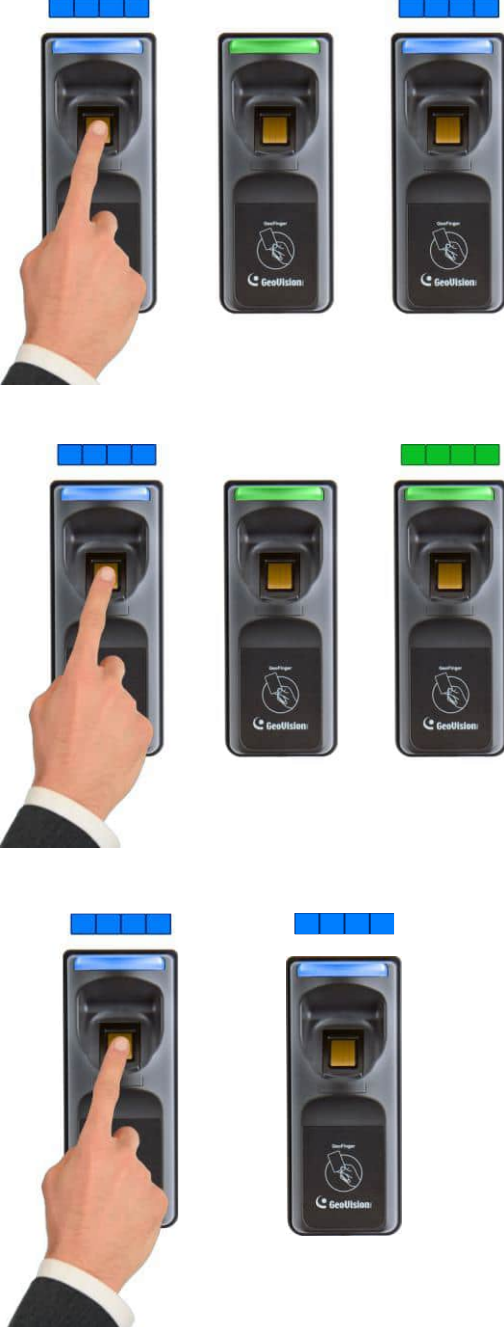
	<p>Step 1:</p> <p>In the standby mode, the light is blue on. Present the Manager Enroll Card. The light blinks green.</p>
---	--

	<p>Step 2:</p> <p>Present the User Card till the light blinks blue.</p> <p>Or present the Manager Enroll Card to exit the enroll mode.</p>
	<p>Step 3:</p> <p>GV-GF1911 / 1912</p> <p>When the light is blinking blue, scan your fingerprint and withdraw when the reader beeps. The light turns green and then back to blue again.</p> <p>Re-scan the same fingerprint till beep, and withdraw your finger. The light again turns green and then blinks green.</p> <p>GV-GF1921 / 1922 / 1922 V2</p> <p>While light is blinking blue, scan your fingerprint. The scan is confirmed by two clicks. Raise the finger and re-scan it. Only withdraw when you hear a long beep. The light blinks blue to indicate that the fingerprint has been enrolled.</p>

	<p>Step 4: GV-GF1911 / 1912 To enroll the second fingerprint, repeat step 3.</p> <p>GV-GF1921 / 1922 / 1922 V2 To enroll the second fingerprint, repeat step 3. Withdraw your finger when you hear a log beep. The light shall blink green.</p>
	<p>Step 5: Present the User Card to record fingerprints till beep. The light turns green and then steady blue.</p> <p>The enrollment is complete and you can use the Card Plus Fingerprint on the fingerprint reader.</p>
<p>Note:</p> <ol style="list-style-type: none">1. When deleting a user, you need the corresponding user card. If you lose the user card, you cannot delete the user from the fingerprint reader.2. The newly enrolled fingerprints will replace the previously enrolled fingerprints.	



4.2 Deletion

Card data will be deleted from the reader and fingerprint templates will be erased from the user card.

Cards Required for Deletion

- Manager Delete Card (supplied in the package)
- User Card

Deletion Procedure

	<p>Step 1:</p> <p>In the standby mode, the light is blue on. Present the Manager Delete Card. The light blinks red.</p>
	<p>Step 2:</p> <p>With the light blinking red, present the User Card. The light blinks green. Present the User Card again to delete all fingerprints stored in the card.</p> <p>When the deletion is complete, the light turns green and then steady blue.</p>

4.3 Using the Fingerprint Reader

After you connect the fingerprint reader to a controller, present a user card. The light on the reader will blink blue. Then scan your enrolled finger to gain access.

1. If the presented fingerprint matches any record in the card, the light will change from blue to green. The access signal will be sent to the controller. Access will be granted.
2. If the presented fingerprint does not match the record in the card, the light will change from steady blue to blinking red, and the reader will beep three times. The light will then return to a steady blue. The reader will not send an access signal to the controller. Access will be denied.

Note: The light on the fingerprint reader turns red if the access does not occur within the GV-ASManager's established schedule.

Chapter 5 Card Only Mode

This Card Only mode allows the users to gain access with a card. This mode is only supported by the fingerprint reader using MIFARE cards or GV-AS ID Cards / Tags.

For **GV-GF1911 / 1912**, if you are not using the GeoVision user card and tag, you need to access the Web interface and select **Enable card only mode** to enable the function. To access the Web interface, see *2.3.2 Accessing the Web Interface* to find the fingerprint reader's IP address for login.

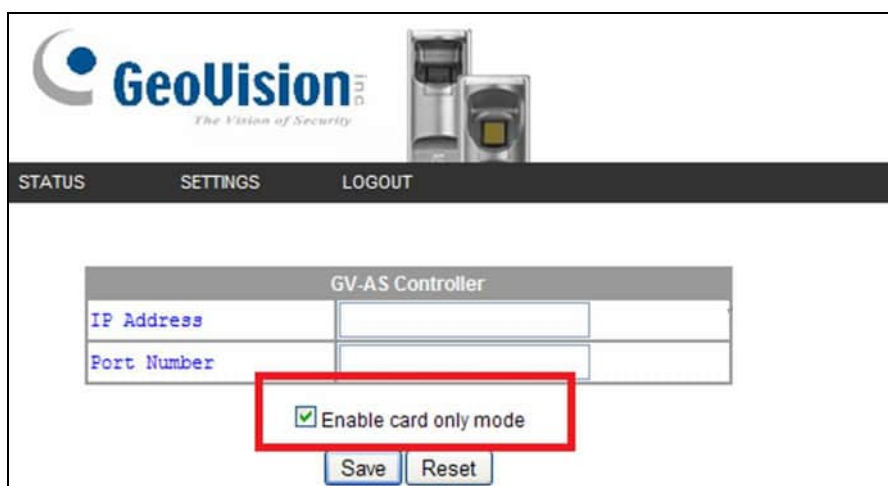





Figure 5-1

5.1 Enrollment

Before enrollment, establish a user account and assign a card to the user on the connected GV-AS Manager. For details, see [4.3 Setting Cards](#) and [4.6 Setting User](#) in *GV-AS Manager User's Manual*.

To enroll, use a MIFARE card and follow the procedure below.

	<p>Step 1:</p> <p>In the standby mode, the light is blue on. Present the Manager Enroll Card. The light starts blinking green.</p>
	<p>Step 2:</p> <p>Present the User Card till the light blinks blue.</p> <p>Or present the Manager Enroll Card to exit the enroll mode.</p>
	<p>Step 3:</p> <p>With the light blinking blue, present the User Card again to confirm. The light turns steady blue and the enrollment is complete.</p>

5.2 Deletion

To delete the access right of a card, inactivate or delete the user account created on the GV-AS Manager. For details, see *4.3 Setting Cards* and *4.6 Setting User* in *GV-ASManager User's Manual*.

5.3 Using the Fingerprint Reader

After connecting the fingerprint reader to a controller, present your enrolled card.

1. If the card is detected as an enrolled card, the light will change from blue to green. The access signal will be sent to the controller. Access will be granted.
2. If the card does not match any of the enrolled cards, the light will change from blue to red. Access will be denied.

Note: The light on fingerprint reader turns red if the access does not occur within the GV-ASManager's established schedule.

Chapter 6 Standalone Mode

The **GV-GF1921 / 1922 / 1922 V2** can work on its own without connecting to GV-AS Controller and GV-AS Manager.

6.1 Physical Connection

Use the data cable provided to connect input and output devices. Each GV-GF1921 / 1922 / 1922 V2 can be connected to two inputs (door sensor and exit button) and one output (door relay).

Connect (+) point of the output device to the yellow wire (**COM**) of the fingerprint reader, connect the (-) points of the output device and the external power supply together, and connect the (+) point of the external power supply to the purple/pink wire (**NO**) or the brown/orange wire (**NC**) of the fingerprint reader based on the state of the output device. For a door sensor, connect the blue wire to the sensor.

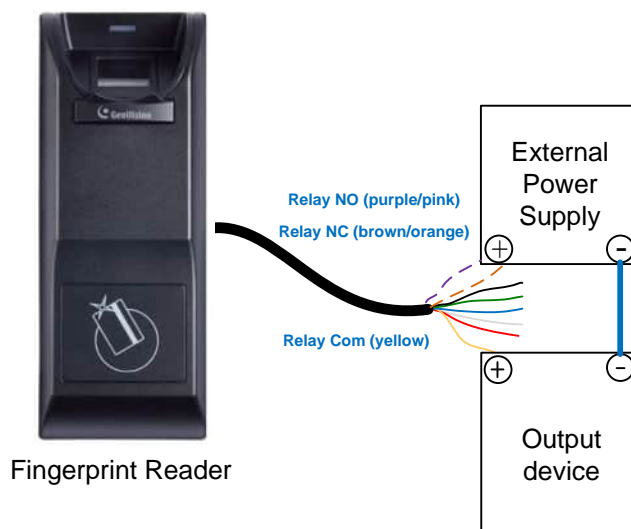

Figure 6-1

Note: The wire color for Relay NO may be in purple or pink, and in brown or orange for Relay NC.

Data Cable

Wire Color	Definition
Red	+12V
Black	GND
Green	IN1 (only for button input)
Blue	IN2 (only for door sensor)
White	IN Com
Brown / Orange	Relay NC
Purple / Pink	Relay NO
Yellow	Relay Com

Note: The I/O interface of GV-GF1921 / 1922 / 1922 V2 only works in Local Mode.

6.2 Enabling the Local Mode

To function as a standalone device, it is required to activate the local mode of the GV-GF1921 / 1922 / 1922 V2 on its Web interface.

Other Configuration

GeoFinger Server configuration

IP: . . .

Port: (from 1025 to 65535)

Master Enroll/Delete Card Number Configuration

Enroll Card Number:

Delete Card Number:

Door Button (IN1) setting: Normal Open Normal Close

Door Sensor (IN2) setting: Normal Open Normal Close

Lock Reset Time: (from 1 to 255)

Held Open Time: (from 5 to 9999)

Local mode configuration

Local mode: Enable Disable

Figure 6-2

To limit enrollment or deletion to one card, type the card's identification number. To set up the input and output status as Normal Open or Normal Close, Lock Reset Time, and Help Open Time, see 7.3 *Other Settings*.

6.3 Fingerprints and Card Enrollment

After connecting your GV-GF1921 / 1922 / 1922 V2 to power and I/O devices, you can enroll fingerprints. The standalone fingerprint reader supports the **Fingerprint Only Mode**.

6.3.1 Fingerprint Only Mode

Use any **MIFARE card** during enrollment for this mode.

- To enroll fingerprints, follow the steps in *4.1 Enrollment*.
- To delete enrolled fingerprints, see *4.2 Deletion*.
- To obtain access, see *4.3 Using the Fingerprint Reader*.

Note: The fingerprint only mode still requires the usage of User Cards to enroll fingerprints because each user's fingerprints need to go along with a card number. However, the enrolled fingerprints are stored on the reader rather than the cards.

Chapter 7 Web Interface for GV-GF1921 / 1922 / 1922 V2

The GV-GF1921 / 1922 / 1922 V2 can be configured through its Web interface. For details on accessing the Web interface, see 2.3.2 *Accessing the Web Interface*.

7.1 Network Settings

Network Configuration

Machine Name

Machine Name

Data Transmission Port

Port Number (from 1025 to 65535, require a reboot)

DHCP Client

Enable
 Disable

IP Address
Subnet Mask
Default Gateway
Domain Name Server

Domain Name Service

Disable
 Enable DDNS

GeoVision DDNS
Host Name
User Name
Password

Status:

Figure 7-1

[Machine Name]

The device name is displayed. Click the space to change the device name.

Note: Valid values for the Machine Name include numerals, letters, and -. No other special characters, symbols or spaces are allowed.

[Data Transmission Port]

The port allows GV-ASManager to transfer fingerprint data to the reader. The default port is **2167**. The port corresponds to an entrance or exit reader port in GV-ASManager (Right-click a door on the Controllers window > Settings), as shown below.

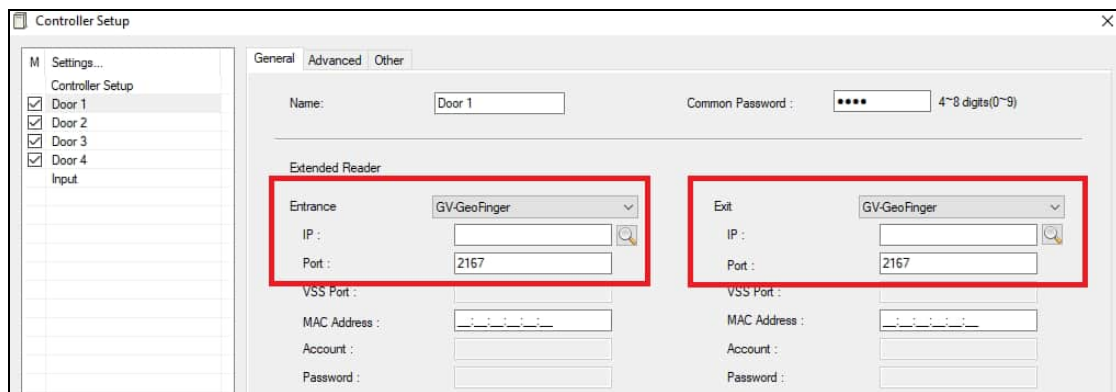

Figure 7-2

[DHCP Client]

By default, the DHCP service is enabled. When the reader is connected to a network, the DHCP server automatically assigns it an unused IP address. This IP address remains unchanged unless you unplug or disconnect your reader from the network. If your router does not support DHCP, the default IP address will be **192.168.0.10**.

To designate a fixed IP address, select **Disable** and specify the **IP Address**, **Subnet Mask**, **Default Gateway** and **Domain Name Server**.

[Domain Name Service]

The Dynamic Domain Name System (DDNS) provides a convenient way of accessing the fingerprint reader when using a dynamic IP. The DDNS assigns a domain name to the fingerprint reader so that the user can log in the Web interface using the domain name, without checking the IP address every time.

To activate this function:

1. Select **Enable DDNS**.
2. Click **GeoVision DDNS** to register for a host name or select the service provider (**GeoVision DDNS** or **DynDNS.org**) you have registered, using the drop-down list.
3. Type the **Host Name**, **User Name** and **Password** to enable the DDNS service.
4. Click **Submit**.

7.2 Card Settings



Figure 7-3

- **Unique Identification (UID):** Select this option when using third-party access cards.
- **GeoVision Card (GID):** Select this option when using the Card + Fingerprint mode. This option enables the fingerprint reader to read GeoVision Identifier (GID) on GeoVision's access cards.
- **GeoVision Card (UID):** Select this option when using the Card + Fingerprint mode. This option enables the fingerprint reader to read GeoVision Identifier (UID) on GeoVision's access cards.

7.3 Other Settings

Other Configuration

GeoFinger Server configuration

IP

Port (from 1025 to 65535)

Master Enroll/Delete Card Number Configuration

Enroll Card Number

Delete Card Number

Door Button (IN1) setting Normal Open Normal Close

Door Sensor (IN2) setting Normal Open Normal Close

Lock Reset Time (from 1 to 255)

Held Open Time (from 5 to 9999)

Local mode configuration

Local mode Enable Disable

Mac Address / Firmware Version

Mac Address 00:13:e2:09:83:47

Firmware Version V1.1.0-20131220

Finger module information

number of enrolled fingerprint templates 2

Reboot System / Set Default

Reboot System

Default Value

Figure 7-4

[GeoFinger Server Configuration]

To transfer fingerprint data back to GV-ASManager for remote fingerprint enrollment, provide the GV-ASManager’s IP address and port number. The default port is **2167**.

The port corresponds to the GeoFinger Server port in GV-ASManager (Tools > Servers > GeoFinger Server), as shown below.

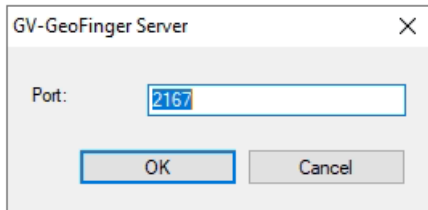

Figure 7-5

[Controller address configuration]

To connect, type the GV-AS Controller's IP address or domain name. This option is only accessible when **Local Mode is disabled**.

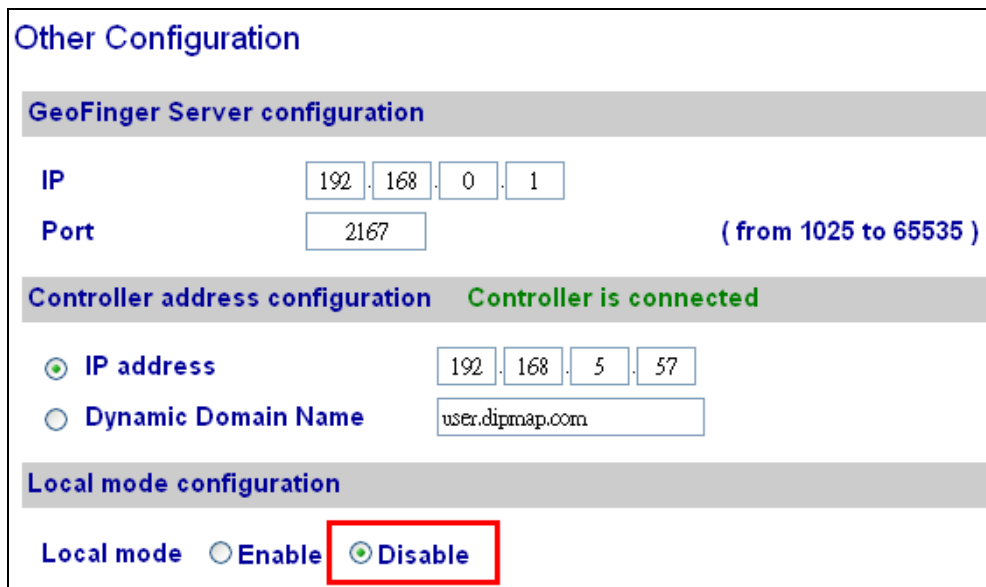

Figure 7-6

[Master Enroll / Delete Card Number Configuration] This section is only available when **Local Mode** is enabled.

- **Enroll / Delete Card Number:** To restrict enrollment or deletion to one card, type the card’s identification number.
- **Door Button Setting:** Select between **Normal Open** or **Normal Close** as the input status.

7 Web Interface for GV-GF1921 / 1922 / 1922 V2

- **Lock Reset Time:** Sets the duration (in seconds) that a door/gate remains open until it is locked again. The default setting is **1** second. For example, if the Lock Reset Time is 5 seconds and access is granted, the door/gate will automatically lock after 5 seconds.
- **Held Open Time:** Sets the duration (in seconds) that the door/gate can be held opened before an alarm is generated. The default setting is **5** seconds. For example, if the Held Open Time is 3 seconds, the fingerprint reader will beep when the door is held open for more than 3 seconds.

[Local mode configuration]

The GV-GF1921 / 1922 / 1922 V2 can function as a standalone device without connecting to GV-AS Controller and GV-AS Manager. This function is disabled by default. To enable this function, select **Enable**.

[MAC Address / Firmware Version]

Shows the device's MAC address and firmware version.

[Finger module information]

Indicates the number of fingerprints enrolled.

[Reboot System / Set Default]

Click the **Reboot** button to reboot the device. The fingerprint reader beeps when the reboot is complete.

To restore the default settings, click the **Default** option. A confirmation dialog box displays, requesting that the Web interface be closed. Click **Yes** to start loading the default settings. When the restoration is complete, the fingerprint reader will beep.

7.4 Firmware

You can upgrade your device firmware through the Web interface. To upgrade firmware by a utility, see *Chapter 8 Upgrading Firmware*.

To upgrade firmware:

1. Click **Browse** and select the firmware file.
2. Click **Upload**. This update process may take 60 seconds to complete.
3. When the update is complete, you will be asked to reboot the reader.
4. Click **OK** to restart the reader.

Firmware Update

After pressing the Update button, please wait while the update request is being processed. After update is completed, the device will reboot automatically. You can re-login afterwards.

Select Firmware: No file chosen

Update State:

Update Process: %

7.5 Account Settings

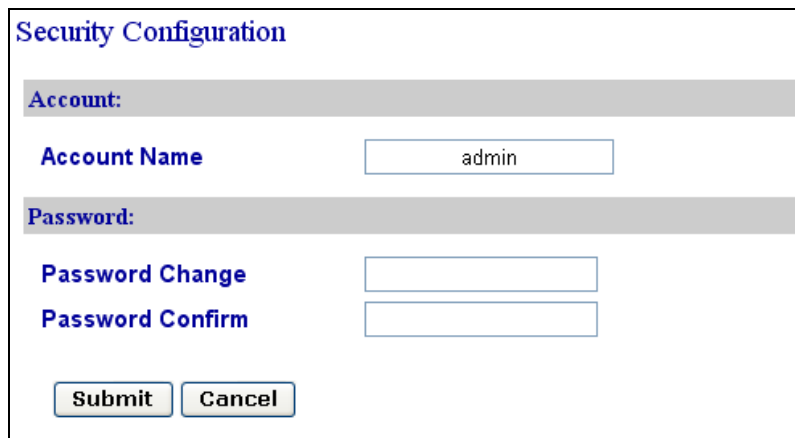

The screenshot shows a web form titled "Security Configuration". It is divided into two main sections: "Account:" and "Password:". The "Account:" section has a label "Account Name" and a text input field containing the text "admin". The "Password:" section has two labels, "Password Change" and "Password Confirm", each followed by an empty text input field. At the bottom of the form are two buttons: "Submit" and "Cancel".

Figure 7-7

[Account]

Rename the account (login ID). The default login ID is **admin**.

[Password]

The default password is **admin**. To change the password, type a new password in **Password Change**, type it again in **Password Confirm** and click **Submit**. The password must be between 4 and 12 characters

Chapter 8 Upgrading Firmware

Upgrade your fingerprint reader firmware to a new version.

8.1 GV-GF1911 / 1912

For the user of **GV-GF1911 / 1912**, firmware upgrade is done through the **AutoISP** software, which is available on the software CD. The AutoISP software will detect the current version of your fingerprint reader and then automatically upgrade it to the new version.

8.1.1 Connecting to a Computer

You need to connect the fingerprint reader to a computer for firmware upgrade. For this connection, one of these optional accessories is required: a **USB cable** (see *PC Service Package, 1.2 Options*), **GV-HUB** or **GV-COM**.

Using the USB Cable

Using the USB cable from the optional PC Service Package, connect the fingerprint reader to a computer as illustrated below.

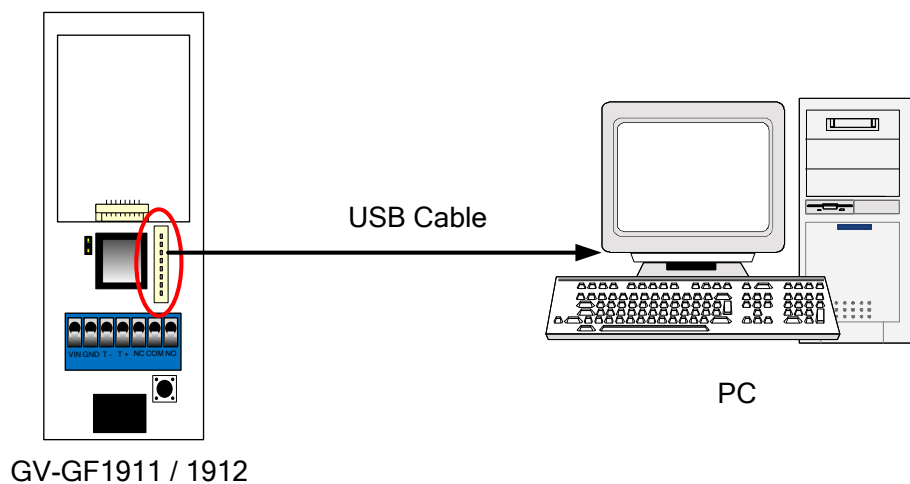

Figure 8-1

Using the GV-HUB or GV-COM

1. Connect the fingerprint reader to a computer through a GV-COM or GV-HUB, which provides the RS-485 to RS-232 function.
2. Power on the fingerprint reader. You can connect the **12V** and **GND** wires from the GV-AS Controller to the fingerprint reader. The diagram below illustrates the connection among fingerprint reader, GV-COM / GV-HUB and a computer. You can also prepare a **12V DC Power Adapter** to connect the fingerprint reader to a power source.

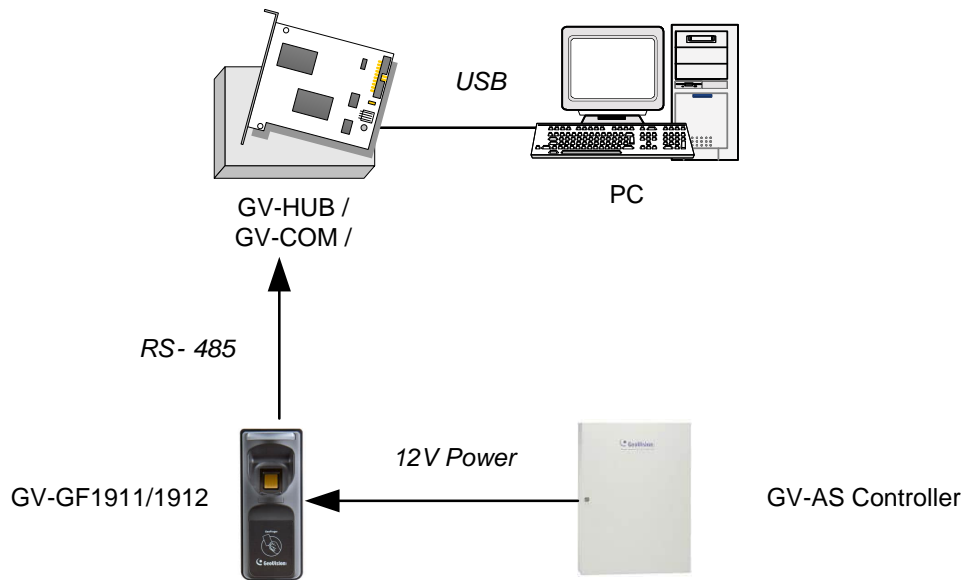

Figure 8-2

8.1.2 Installing Software

To upgrade the firmware for the fingerprint readers, you need to install the **AutoISP** software from the software CD to the dedicated computer. To install firmware upgrade software, follow the steps below:

1. Insert the software CD to the computer. It runs automatically and the following window pops up.



Figure 8-3

2. Select **Install GV-GF Fingerprint Reader Utility** to install the **AutoISP**.
3. Run **AutoISP**. This dialog box appears.

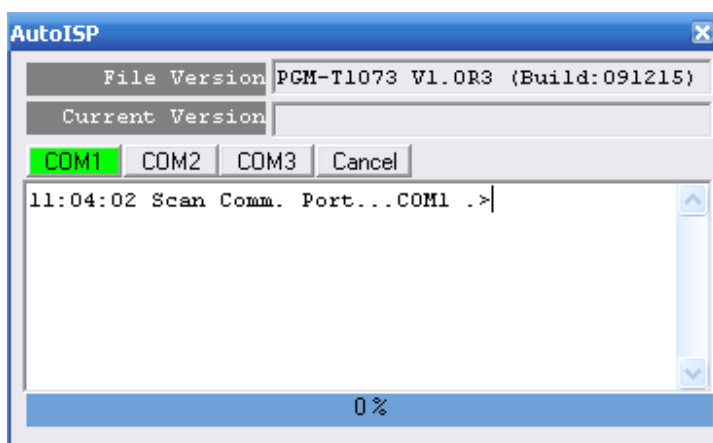



Figure 8-4

8 Upgrading Firmware

4. Wait for the **AutoISP** detecting the COM port that the fingerprint reader is connected to and automatically upgrading the firmware.
5. When the **AutoISP** automatically finishes firmware upgrading, the current version number shown in the dialog box will match the file version number. Click  to close the dialog box.

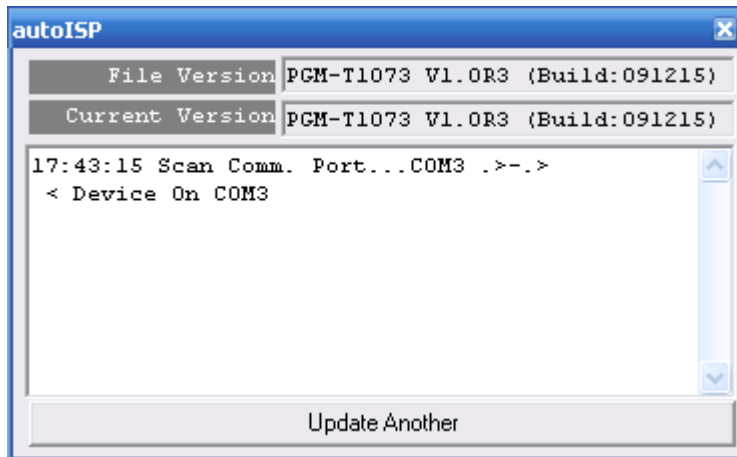



Figure 8-5

8.2 GV-GF1921 / 1922 / 1922 V2

GeoVision periodically releases updated firmware on the company [website](#). To load the new firmware into the camera, follow the instructions below.

The GV-GF1921 / 1922 / 1922 V2 can be upgraded either through its Web interface or using GV-IP Device Utility.

8.2.1 Through the Utility

1. Make sure the PC used to configure the IP address is under the same LAN as the reader. Download and install **GV-IP Device Utility** from the company [website](#).
2. On the GV-IP Utility window, click the  button to search for IP devices connected to the same LAN. Click the **Name** or **Mac Address** column to sort.
3. Find the reader with its Mac Address.
4. Click on its IP address, and select **Configure**.
5. Select **Firmware Upgrade**, and click **Browse** to select a firmware file from your local computer.

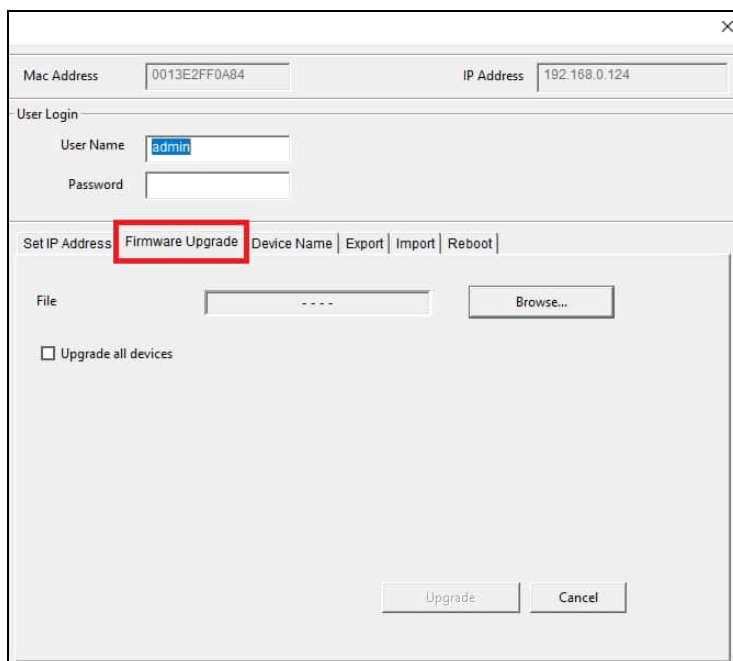

Figure 8-6

6. At the User Login section, type the user name and password of the reader.
7. Click **Upgrade**.

Chapter 9 LED Indicator

9.1 GV-GF1911 / 1912 / 1921 / 1922 / 1922 V2 (connected with GV-AS Manager)

LED Status		Description
Blue	Steady	The reader is ready for use.
	Flash continuously	The reader is waiting to detect a fingerprint during enrollment.
		The reader is waiting to detect a fingerprint to grant access under Card + Finger mode.
Green	Flash once	The detected fingerprint or card matches an enrolled account and the access is granted.
		An enrollment is successfully deleted. *for GV-GF1911 / 1912 only
	Flash continuously	The reader is waiting to detect a card during enrollment.
		The reader is waiting to detect a card for deletion. *for GV-GF1911 / 1912 only
Red	Flash once	The detected fingerprint or card does not match any enrolled account or when the access is not within the established schedule. The access is denied.
	Flash continuously	The reader is waiting to detect a fingerprint or card for deletion.
	Flash rapidly	The fingerprint or card is being deleted. *for GV-GF1921 / 1922 / 1922 V2 only
Purple	Steady	The reader is not connected to GV-AS Controller. *for GV-GF1921 / 1922 / 1922 V2 only

Yellow	Flash once	<p>The fingerprint is not found.</p> <p>*for GV-GF1921 / 1922 / 1922 V2 only</p>
White	Steady	<p>The IP and Gateway addresses do not match. (The first three sets of numbers should match).</p> <p>For example, the white light appears when the device's IP address is configured to 10.10.0.100 and gateway is 192.168.0.1. Log in the device with 10.10.0.100 in this case, and modify the IP address or gateway to the same networked section. After the modification, the device will reboot automatically and display a purple or blue light indicating that it is ready to use.</p> <p>*for GV-GF1921 / 1922 only</p>

9.2 GV-GF1921 / 1922 / 1922 V2 (Standalone)

LED Status		Description
Blue	Steady	The reader is ready for use.
	Flash once	The reader is downloading, deleting or checking the fingerprint.
	Flash continuously	The reader is waiting to detect a fingerprint during enrollment.
Green	Flash once	The detected fingerprint or card matches an enrolled account and the access is granted.
Red	Flash once	The detected fingerprint or card does not match any enrolled account or when the access is not within the established schedule. The access is denied.
	Flash continuously	The reader is waiting to detect a fingerprint or card for deletion.
	Flash rapidly	The fingerprint or card is being deleted.
White	Steady	<p>The IP and Gateway addresses do not match. (The first three sets of numbers should match).</p> <p>For example, the white light appears when the device's IP address is configured to 10.10.0.100 and gateway is 192.168.0.1. Log in the device with 10.10.0.100 in this case, and modify the IP address or gateway to the same networked section. After the modification, the device will reboot automatically and display a purple or blue light indicating that it is ready for use.</p> <p>*for GV-GF1921 / 1922 only</p>

Appendix

How to access the reader's Web interface?

The reader's Web interface must be accessed using **Internet Explorer mode** in Microsoft Edge.

1. Open **Internet Properties** from the Run dialog box. Press **Win + R** to bring up the Run dialog, type **inetcpl.cpl** and click **OK**.

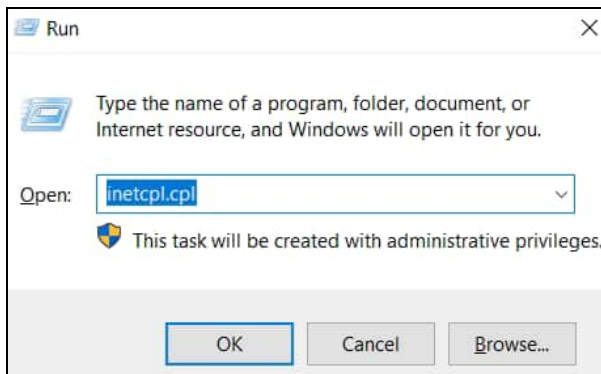

2. Select **Advanced > Use TLS 1.0** and click **OK**.

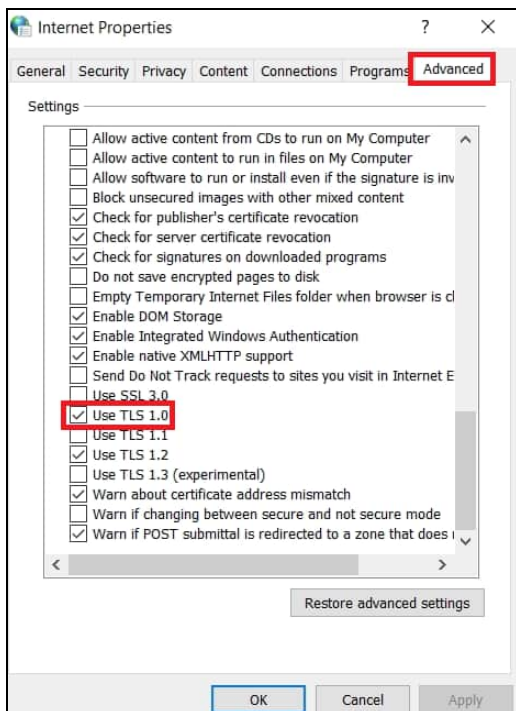

3. In the address bar for Microsoft Edge, type **edge://settings/defaultbrowser** and press **Enter**.

4. Select **Allow** for Slide the Allow sites to be reloaded in Internet Explorer. Restart Microsoft Edge.
5. Select **Web Page** for the reader found using GV-IP Device Utility. Alternatively, enter its IP address into Edge's address bar.

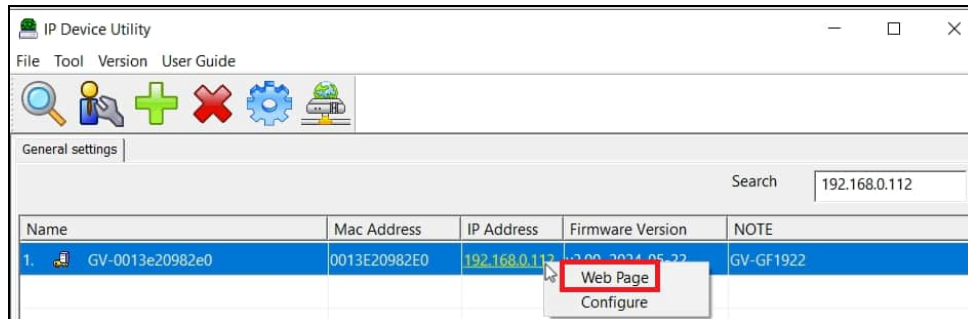

6. On this page, select **More Information** and then **Go to the webpage (not recommended)**.

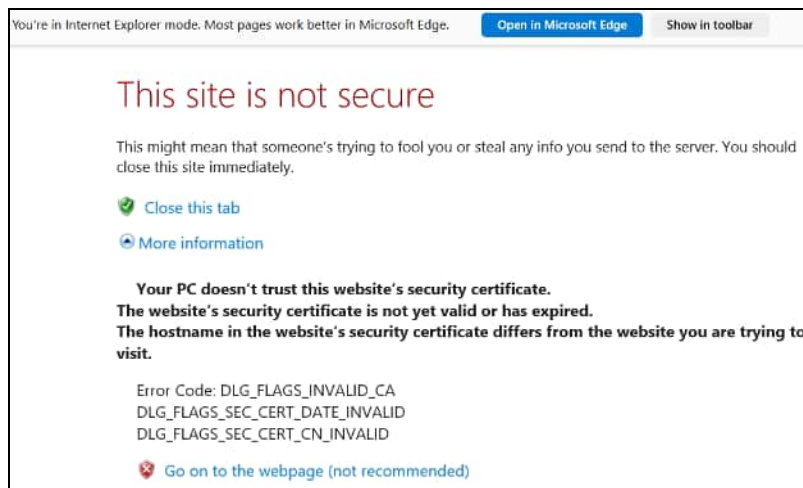

7. Enter the reader's ID and password to log in its Web interface. The default login credentials are admin / admin.