



AXIS M433x-PLVE Series Panoramic Camera
M4337-PLVE Panoramic Camera
M4338-PLVE Panoramic Camera

User manual

Table of Contents

Installation 4
 Preview mode 4
 Get started..... 5
 Find the device on the network..... 5
 Browser support 5
 Open the device's web interface..... 5
 Create an administrator account..... 5
 Secure passwords..... 6
 Make sure that no one has tampered with the device software 6
 Configure your device..... 7
 Basic settings 7
 Adjust the image..... 7
 Rotate the image with digital roll..... 7
 Configure the quad view 7
 Configure the dual view 9
 Level the camera 10
 Straighten the horizon 10
 Select exposure mode 11
 Benefit from IR light in low-light conditions by using night mode 11
 Optimize IR illumination..... 11
 Reduce noise in low-light conditions 11
 Reduce motion blur in low-light conditions..... 12
 Handle scenes with strong backlight..... 12
 Verify the pixel resolution..... 12
 Hide parts of the image with privacy masks..... 13
 Show an image overlay 13
 Show a text overlay 13
 Adjust the camera view (PTZ)..... 13
 13
 Create a guard tour with preset positions..... 13
 View and record video 14
 Reduce bandwidth and storage 14
 Set up network storage 14
 Record and watch video 15
 Verify that no one has tampered with the video..... 15
 Set up rules for events 15
 Trigger an action 15
 Record video when the camera detects an object..... 16
 Show a text overlay in the video stream when the device detects an object 16
 Direct the camera to a preset position when the camera detects motion 17
 Provide visual indication of an ongoing event..... 17
 Zoom in on a specific area automatically with gatekeeper 18
 Detect tampering with input signal 18
 Trigger a notification when the enclosure is opened 19
 Send an email automatically if someone spray paints the lens..... 19
 Audio..... 20
 Add audio capability to your product using portcast..... 20
 Connect to a network speaker..... 20
 Connect to a strobe siren 20
 The web interface 22
 Learn more..... 23
 View area 23
 Capture modes..... 23

- Capture mode views.....23
- Privacy masks26
- Overlays26
- Streaming and storage.....27
 - Video compression formats.....27
 - How do Image, Stream, and Stream profile settings relate to each other?.....27
 - Bitrate control.....28
- Edge-to-edge technology.....29
 - Speaker pairing29
 - Network pairing29
- Analytics and apps30
 - AXIS Object Analytics.....30
 - AXIS Image Health Analytics.....31
 - Metadata visualization.....31
- Cybersecurity.....31
 - Axis security notification service31
 - Vulnerability management.....31
 - Secure operation of Axis devices31
- Specifications.....32
 - Product overview32
 - LED indicators.....32
 - SD card slot.....32
 - Buttons.....33
 - Control button33
 - Intrusion alarm sensor.....33
 - Connectors.....33
 - Network connector33
 - I/O connector33
- Clean your device.....35
- Troubleshooting.....36
 - Reset to factory default settings36
 - AXIS OS options36
 - Check the current AXIS OS version36
 - Upgrade AXIS OS.....37
 - Technical problems and possible solutions37
 - Performance considerations40
 - Contact support.....40

Installation

Preview mode

Preview mode is ideal for installers when fine tuning the camera view during the installation. No login is required to access the camera view in preview mode. It is available only in factory defaulted state for a limited time from powering up the device.



To watch this video, go to the web version of this document.

This video demonstrates how to use preview mode.

Get started

Find the device on the network

To find Axis devices on the network and assign them IP addresses in Windows®, use AXIS IP Utility or AXIS Device Manager. Both applications are free and can be downloaded from axis.com/support.

For more information about how to find and assign IP addresses, go to *How to assign an IP address and access your device*.

Browser support

You can use the device with the following browsers:

	Chrome™	Edge™	Firefox®	Safari®
Windows®	✓	✓	*	*
macOS®	✓	✓	*	*
Linux®	✓	✓	*	*
Other operating systems	*	*	*	*

✓: Recommended

*: Supported with limitations

Open the device's web interface

1. Open a browser and type the IP address or host name of the Axis device. If you don't know the IP address, use AXIS IP Utility or AXIS Device Manager to find the device on the network.
2. Type the username and password. If you access the device for the first time, you must create an administrator account. See *Create an administrator account, on page 5*.

For descriptions of all features and settings in the web interface of devices with AXIS OS, see *AXIS OS web interface help*.

Create an administrator account

The first time you log in to your device, you must create an administrator account.

1. Enter a username.
2. Enter a password. See *Secure passwords, on page 6*.
3. Re-enter the password.
4. Accept the license agreement.
5. Click **Add account**.

Important

The device has no default account. If you lose the password for your administrator account, you must reset the device. See *Reset to factory default settings, on page 36*.

Secure passwords

Important

Use HTTPS (which is enabled by default) to set your password or other sensitive configurations over the network. HTTPS enables secure and encrypted network connections, thereby protecting sensitive data, such as passwords.

The device password is the primary protection for your data and services. Axis devices do not impose a password policy as they may be used in various types of installations.

To protect your data we strongly recommend that you:

- Use a password with at least 8 characters, preferably created by a password generator.
- Don't expose the password.
- Change the password at a recurring interval, at least once a year.

Make sure that no one has tampered with the device software

To make sure that the device has its original AXIS OS, or to take full control of the device after a security attack:

1. Reset to factory default settings. See *Reset to factory default settings, on page 36*.
After the reset, secure boot guarantees the state of the device.
2. Configure and install the device.

Configure your device

This section covers all the important configurations that an installer needs to do to get the product up and running after the hardware installation has been completed.

Basic settings

Set the capture mode

1. Go to **Video > Installation > Capture mode**.
2. Click **Change**.
3. Select a capture mode and click **Save and restart**.
See also *Capture modes, on page 23*.

Set the mounting position

1. Go to **Video > Installation > Mounting position**.
2. Click **Change**.
3. Select a mounting position and click **Save and restart**.

Set the power line frequency

1. Go to **Video > Installation > Power line frequency**.
2. Select a power line frequency and click **Save and restart**.

Adjust the image

This section includes instructions about configuring your device. If you want to learn more about how certain features work, go to *Learn more, on page 23*.

Rotate the image with digital roll

Note

If you rotate the image, all views are affected.

To rotate the 360° view, go to **Video > Installation** and use the **Roll** slider.

You can also enter a value for the roll angle in the text field.

Configure the quad view

The quad view shows four dewarped streams, called view areas, in one view. Configure each view area to change the quad view.

Note

Quad view is available in these mounting positions:

- Desk
- Ceiling

1. Go to **Video > Stream**.

2. In the drop-down menu, select



View Area 1.

3. Pan, tilt and zoom the view area according to your needs.
4. Repeat for view area 2, 3, and 4.

5. Select



Quad View to show the four view areas.

Configure the dual view

The dual view combines view area 1 and view area 3 in the same stream. To configure it:

1. Go to Video > Stream.

2. In the drop-down menu, select





Dual View.

3. Pan, tilt, and zoom view area 1 and view area 3 to the desired position.
4. Pull the dual view.

Level the camera

To adjust the view in relation to a reference area or an object, use the level grid in combination with the digital roll slider in the camera.

1. Go to **Video > Installation** and click  **A**.
2. Click  to show the level grid.
3. Adjust the camera using the **Roll** slider until the position of the reference area or the object is aligned with the level grid.

Straighten the horizon

A fisheye lens is a wide-angle lens that has a curved protruding front, which makes the image circular. To compensate for the image distortion, you can use **Horizon straightening** to get an image that is perceived as straight and in line with the horizon.

1. Go to **Video > Installation** and click **Change**.
2. Set **Capture mode** to a dewarped view.
3. Set **Mounting position** to **Wall mounted**.
4. Click **Save** and restart.
5. Go to **Video > Stream** and set the view to **Panorama**.
6. Click **Horizon straightening** and use the **Horizon line** slider to adjust the horizon.
7. Use the **Tilt** slider to tilt the image.

Select exposure mode

To improve image quality for specific surveillance scenes, use exposure modes. Exposure modes lets you control aperture, shutter speed, and gain. Go to **Video > Image > Exposure** and select between the following exposure modes:

- For most use cases, select **Automatic** exposure.
- For environments with certain artificial lighting, for example fluorescent lighting, select **Flicker-free**. Select the same frequency as the power line frequency.
- To lock the current exposure settings, select **Hold current**.

Benefit from IR light in low-light conditions by using night mode

Your camera uses visible light to deliver color images during the day. But as the visible light diminishes, color images become less bright and clear. If you switch to night mode when this happens, the camera uses both visible and near-infrared light to deliver bright and detailed black-and-white images instead. You can set the camera to switch to night mode automatically.

1. Go to **Video > Image > Day-night mode**, and make sure that the **IR-cut filter** is set to **Auto**.
2. To use the built-in IR light when the camera is in night mode, turn on **Allow illumination** and **Synchronize illumination**.

Optimize IR illumination

Depending on the installation environment and the conditions around the camera, for example external light sources in the scene, you can sometimes improve the image quality if you manually adjust the intensity of the LEDs. If you have problems with reflections from the LEDs, you can try to reduce the intensity.

1. Go to **Video > Image > Day-night mode**.
2. Turn on **Allow illumination**.
3. Click  in the live view and select **Manual**.
4. Adjust the intensity.

Reduce noise in low-light conditions

To reduce noise in low-light conditions, you can adjust one or more of the following settings:

- Adjust the trade-off between noise and motion blur. Go to **Video > Image > Exposure** and move the **Blur-noise trade-off** slider toward **Low noise**.
- Set the exposure mode to automatic.

Note

A high max shutter value can result in motion blur.

- To slow down the shutter speed, set max shutter to the highest possible value.
- If there is an **Aperture** slider, move it towards **Open**.

Reduce motion blur in low-light conditions

To reduce motion blur in low-light conditions, adjust one or more of the following settings in **Video > Image > Exposure**:

Note

When you increase the gain, image noise also increases.

- Set **Max shutter** to a shorter time, and **Max gain** to a higher value.

If you still have problems with motion blur:

- Increase the light level in the scene.
- Mount the camera so that objects move toward it or away from it rather than sideways.

Handle scenes with strong backlight

Dynamic range is the difference in light levels in an image. In some cases the difference between the darkest and the brightest areas can be significant. The result is often an image where either the dark or the bright areas are visible. Wide dynamic range (WDR) makes both dark and bright areas of the image visible.



1. Go to **Video > Image > Wide dynamic range**.
2. Use the **Local contrast** slider to adjust the amount of WDR.
3. Use the **Tone mapping** slider to adjust the amount of WDR.
4. If you still have problems, go to **Exposure** and adjust the **Exposure zone** to cover the area of interest.

Find out more about WDR and how to use it at axis.com/solutions/wide-dynamic-range-wdr.

Verify the pixel resolution

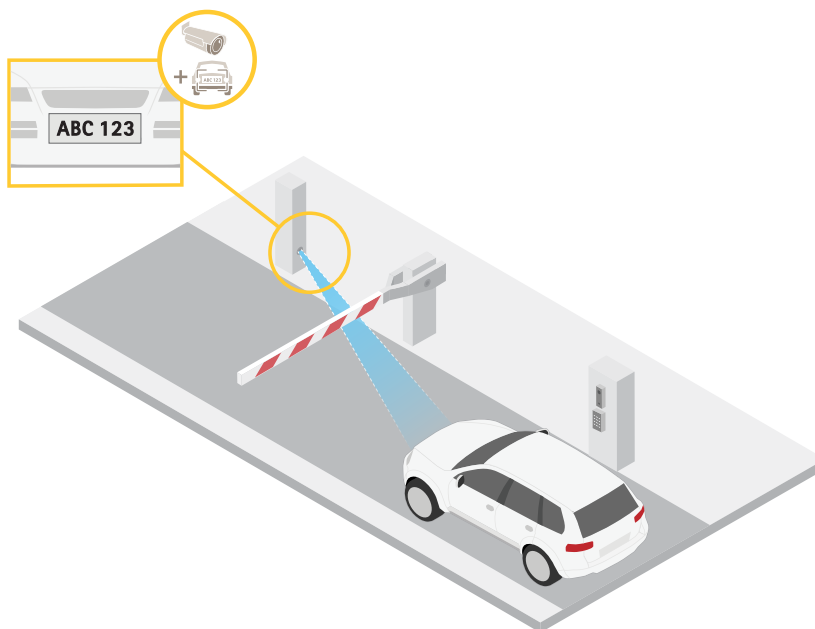
To verify that a defined part of the image contains enough pixels to, for example, recognize license plates, you can use the pixel counter.



1. Go to **Video > Image**.
2. Click  **A**.
3. Click  for **Pixel counter**.

4. In the camera's live view, adjust the size and position of the rectangle around the area of interest, for example where you expect license plates to appear.
5. You can see the number of pixels for each of the rectangle's sides, and decide if the values are enough for your needs.

Hide parts of the image with privacy masks

You can create one or several privacy masks to hide parts of the image.

1. Go to **Video > Privacy masks**.
2. Click **+**.
3. Click the new mask and type a name.
4. Adjust the size and placement of the privacy mask according to your needs.
5. To change the color for all privacy masks, click **Privacy masks** and select a color.

See also *Privacy masks*, on page 26

Show an image overlay

You can add an image as an overlay in the video stream.

1. Go to **Video > Overlays**.
2. Click **Manage images**.
3. Upload or drag and drop an image.
4. Click **Upload**.
5. Select **Image** from the drop-down list and click **+**.
6. Select the image and a position. You can also drag the overlay image in the live view to change the position.

Show a text overlay

You can add a text field as an overlay in the video stream. This is useful for example when you want to display the date, time or a company name in the video stream.

1. Go to **Video > Overlays**.
2. Select **Text** and click **+**.
3. Type the text you want to display, or select modifiers to show for example the current date.
4. Select a position. You can also click-and-drag the overlay in the live view to change the position.

Adjust the camera view (PTZ)

1. Go to **PTZ > Limits**.
2. Set the limits as needed.

Create a guard tour with preset positions

A guard tour displays the video stream from different preset positions either in a predetermined or random order, and for configurable periods of time.

1. Go to **PTZ > Guard tours**.

2. Click  **Guard tour**.
3. Select **Preset position** and click **Create**.
4. Under **General settings**:
 - Enter a name for the guard tour and specify the pause length between each tour.
 - If you want the guard tour to go to the preset positions in a random order, turn on **Play guard tour in random order**.
5. Under **Step settings**:
 - Set the duration for the preset.
 - Set the move speed, which controls how fast to move to the next preset.
6. Go to **Preset positions**.
 - 6.1. Select the preset positions that you want in your guard tour.
 - 6.2. Drag them to the **View order** area, and click **Done**.
7. To schedule the guard tour, go to **System > Events**.

View and record video

This section includes instructions about configuring your device. To learn more about how streaming and storage works, go to *Streaming and storage*, on page 27.

Reduce bandwidth and storage

Important

Reducing the bandwidth can lead to loss of detail in the image.

1. Go to **Video > Stream**.
2. Click  **A** in the live view.
3. Select **Video format AV1** if your device supports it. Otherwise select **H.264**.
4. Go to **Video > Stream > General** and increase **Compression**.
5. Go to **Video > Stream > Zipstream** and do one or more of the following:

Note

The **Zipstream** settings are used for all video encodings except MJPEG.

- Select the **Zipstream Strength** that you want to use.
- Turn on **Optimize for storage**. This can only be used if the video management software supports B-frames.
- Turn on **Dynamic FPS**.
- Turn on **Dynamic GOP** and set a high **Upper limit GOP length** value.

Note

Most web browsers don't support H.265 decoding and because of this the device doesn't support it in its web interface. Instead you can use a video management system or application that supports H.265 decoding.

Set up network storage

To store recordings on the network, you need to set up your network storage.

1. Go to **System > Storage**.
2. Click  **Add network storage** under **Network storage**.
3. Type the IP address of the host server.

4. Type the name of the shared location on the host server under **Network share**.
5. Type the username and password.
6. Select the SMB version or leave it on **Auto**.
7. Select **Add share without testing** if you experience temporary connection issues, or if the share is not yet configured.
8. Click **Add**.

Record and watch video

Record video directly from the camera

1. Go to **Video > Stream**.

2. To start a recording, click  .

If you haven't set up any storage, click  and  . For instructions on how to set up network storage, see *Set up network storage, on page 14*

3. To stop recording, click  again.

Watch video

1. Go to **Recordings**.
2. Click  for your recording in the list.

Verify that no one has tampered with the video

With signed video, you can make sure that no one has tampered with the video recorded by the camera.

1. Go to **Video > Stream > General** and turn on **Signed video**.
2. Record video directly on the device, or use AXIS Camera Station (5.46 or later) or another compatible video management software. For AXIS Camera Station instructions, see the *AXIS Camera Station user manual*.
3. Export the recorded video.
4. Use *Axis signed media verifier* tool to verify the recording.

Set up rules for events

You can create rules to make your device perform an action when certain events occur. A rule consists of conditions and actions. The conditions can be used to trigger the actions. For example, the device can start a recording or send an email when it detects motion, or show an overlay text while the device is recording.

To learn more, see *Get started with rules for events*.

Trigger an action

1. Go to **System > Events** and add a rule. The rule defines when the device will perform certain actions. You can set up rules as scheduled, recurring, or manually triggered.
2. Enter a **Name**.
3. Select the **Condition** that must be met to trigger the action. If you specify more than one condition for the rule, all of the conditions must be met to trigger the action.
4. Select which **Action** to perform when the conditions are met.

Record video when the camera detects an object

This example explains how to set up the camera to start recording to the SD card when the camera detects an object. The recording will include five seconds before detection and one minute after detection ends.

Before you start:

- Make sure you have an SD card installed.

Make sure that AXIS Object Analytics is running:

1. Go to **Apps > AXIS Object Analytics**.
2. Start the application if it is not already running.
3. Make sure you have set up the application according to your needs.

Create a rule:

1. Go to **System > Events** and add a rule.
2. Type a name for the rule.
3. In the list of conditions, under **Application**, select **Object Analytics**.
4. In the list of actions, under **Recordings**, select **Record video while the rule is active**.
5. In the list of storage options, select **SD_DISK**.
6. Select a camera and a stream profile.
7. Set the prebuffer time to 5 seconds.
8. Set the postbuffer time to 1 minute.
9. Click **Save**.



Show a text overlay in the video stream when the device detects an object

This example explains how to display the text "Motion detected" when the device detects an object.

Make sure that AXIS Object Analytics is running:

1. Go to **Apps > AXIS Object Analytics**.
2. Start the application if it is not already running.
3. Make sure you have set up the application according to your needs.

Add the overlay text:

1. Go to **Video > Overlays**.
2. Under **Overlays**, select **Text** and click .
3. Enter #D in the text field.
4. Choose text size and appearance.
5. To position the text overlay, click  and select an option.

Create a rule:

1. Go to **System > Events** and add a rule.
2. Type a name for the rule.
3. In the list of conditions, under **Application**, select **Object Analytics**.
4. In the list of actions, under **Overlay text**, select **Use overlay text**.
5. Select a video channel.
6. In **Text**, type "Motion detected".
7. Set the duration.
8. Click **Save**.

Direct the camera to a preset position when the camera detects motion

This example explains how to set up the camera to go to a preset position when it detects motion in the image.

Make sure that AXIS Object Analytics is running:

1. Go to **Apps > AXIS Object Analytics**.
2. Start the application if it is not already running.
3. Make sure you have set up the application according to your needs.

Add a preset position:

Go to **PTZ** and set where you want the camera to be directed by creating a preset position.

Create a rule:

1. Go to **System > Events** and add a rule.
2. Type a name for the rule.
3. In the list of conditions, under **Application**, select **Object Analytics**.
4. In the list of actions, select **Go to preset position**.
5. Select the preset position you want the camera to go to.
6. Click **Save**.

Provide visual indication of an ongoing event

You have the option to connect the AXIS I/O Indication LED to your network camera. This LED can be configured to turn on whenever certain events occur in the camera. For example, to let people know that video recording is in progress.



Required hardware

- AXIS I/O Indication LED
- An Axis network video camera

Note

For instructions on how to connect the AXIS I/O Indication LED, see the installation guide provided with the product.

The following example shows how to configure a rule that turns on the AXIS I/O Indication LED to indicate that camera is recording.

1. Go to **System > Accessories > I/O ports**.
2. For the port that you connected the AXIS I/O Indication LED to, click  to set the direction to **Output**, and click  to set the normal state to **Circuit open**.
3. Go to **System > Events**.
4. Create a new rule.
5. Select the **Condition** that must be met to trigger the camera to start recording. It can, for example, be a time schedule or motion detection.
6. In the list of actions, select **Record video**. Select a storage space. Select a stream profile or create a new. Also set the **Prebuffer** and **Postbuffer** as required.
7. Save the rule.
8. Create a second rule and select the same **Condition** as in the first rule.
9. In the list of actions, select **Toggle I/O while the rule is active**, and then select the port the AXIS I/O Indication LED is connected to. Set the state to **Active**.
10. Save the rule.

Other scenarios where AXIS I/O Indication LED can be used are for example:

- Configure the LED to turn on when the camera starts, to indicate the presence of the camera. Select **System ready** as a condition.
- Configure the LED to turn on when live stream is active to indicate that a person or a program is accessing a stream from the camera. Select **Live stream accessed** as a condition.

Zoom in on a specific area automatically with gatekeeper

This example explains how to use the gatekeeper functionality to make the camera zoom in automatically on the license plate of a car that passes through a gate. When the car has passed, the camera zooms out to the home position.

Create the preset positions:

1. Go to **PTZ > Preset positions**.
2. Create the home position that includes the entrance of the gate.
3. Create the zoomed-in preset position so that it covers the area in the image where you assume that the license plate will appear.

Set up motion detection:

1. Go to **Apps** and start and open **AXIS Object Analytics**.
2. Create an object in area scenario for vehicles, with an include area that covers the entrance of the gate.

Create a rule:

1. Go to **System > Events** and add a rule.
2. Name the rule "Gatekeeper".
3. In the list of conditions, under **Application**, select the **Object Analytics** scenario.
4. In the list of actions, under **Preset positions**, select **Go to preset position**.
5. Select a **Video channel**.
6. Select the **Preset position**.
7. To make the camera wait a while before it returns to the home position, set a time for **Home timeout**.
8. Click **Save**.

Detect tampering with input signal

This example explains how to send an email when the input signal is cut or short-circuited. For more information about the I/O connector, see [page 33](#).

1. Go to **System > Accessories > I/O ports** and turn on **Supervised** for the relevant port.

Add an email recipient:

1. Go to **System > Events > Recipients** and add a recipient.
2. Type a name for the recipient.
3. Select **Email** as the notification type.
4. Type the recipient's email address.
5. Type the email address that you want the camera to send notifications from.
6. Provide the login details for the sending email account, along with the SMTP hostname and port number.
7. To test your email setup, click **Test**.
8. Click **Save**.

Create a rule:

1. Go to **System > Events > Rules** and add a rule.
2. Type a name for the rule.

3. In the list of conditions, under **I/O**, select **Supervised input tampering is active**.
4. Select the relevant port.
5. In the list of actions, under **Notifications**, select **Send notification to email** and then select the recipient from the list.
6. Type a subject line and message for the email.
7. Click **Save**.

Trigger a notification when the enclosure is opened

This example explains how to set up an email notification when the housing or casing of the device is opened.

Add an email recipient:

1. Go to **System > Events > Recipients** and click **Add recipient**.
2. Type a name for the recipient.
3. Select **Email** as the notification type.
4. Type the recipient's email address.
5. Type the email address that you want the camera to send notifications from.
6. Provide the login details for the sending email account, along with the SMTP hostname and port number.
7. To test your email setup, click **Test**.
8. Click **Save**.

Create a rule:

9. Go to **System > Events > Rules** and click **Add a rule**.
10. Type a name for the rule.
11. In the list of conditions, select **Casing open**.
12. In the list of actions, select **Send notification to email**.
13. Select a recipient from the list.
14. Type a subject line and message for the email.
15. Click **Save**.

Send an email automatically if someone spray paints the lens

This example explains how to set up a rule in the camera's web interface that sends an email when the image has been blocked for more than 40 seconds, for example by a spray painted lens.

Before you start:

- Create an email recipient in the camera's web interface.

In AXIS Image Health Analytics:

1. Turn on **Blocked image**.
2. Set **Validation period** to 40 seconds.

In the camera's web interface:

3. Go to **System > Events** and add a rule.
4. Type a name for the rule.
5. In the list of conditions, under **Applications**, select **Image Health Analytics – Block**.
6. In the list of actions, under **Notifications**, select **Send notification to email**.
7. Select the recipient from the list.
8. Type a subject and message for the email.

9. Click Save.

Audio

Add audio capability to your product using portcast

With portcast technology, you can add audio capability to your product. It allows audio and I/O communication digitally over the network cable between the camera and the interface.

To add audio capability to your Axis network video device, connect the portcast compatible Axis audio device and I/O Interface between your device and the PoE switch which provides power.

1. Connect the Axis network video device (1) and the Axis portcast device (2) with a PoE cable.
2. Connect the Axis portcast device (2) and the PoE switch (3) with a PoE cable.

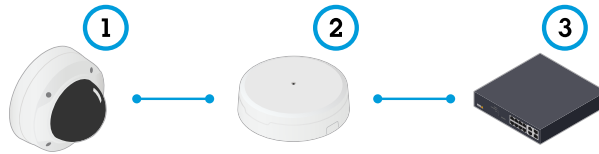

- 1 Axis network video device
- 2 Axis portcast device
- 3 Switch

Once the devices are connected, an audio tab becomes visible in the settings for your Axis network video device. Go to the audio tab and turn on **Allow audio**.

See your Axis portcast device's user manual for more information.

Connect to a network speaker

Network speaker pairing allows you to use a compatible Axis network speaker as if it is connected directly to the camera. Once paired, the speaker acts as an audio out device where you can play audio clips and transmit sound through the camera.

Important

For this feature to work with a video management software (VMS), you must first pair the camera with the network speaker, then add the camera to your VMS.

Pair camera with network speaker

1. Go to **System > Edge-to-edge > Pairing**.
2. Click  **Add** and select the pairing type **Audio** from the drop-down list.
3. Select **Speaker pairing**.
4. Type the network speaker's IP address, username and password.
5. Click **Connect**. A confirmation message appears.

Connect to a strobe siren

Network pairing allows you to pair a camera with a compatible Axis device with light and siren functionality. Once paired, the camera can configure and maintain both devices.

Pair the camera with a strobe siren:

1. Go to **System > Edge-to-edge > Pairing**.
2. Click  **Add** and select the pairing type **Network pairing** from the drop-down list.
3. Type the IP address, username and password of the strobe siren.

4. Click **Connect**. A confirmation message appears.

To find devices directly on the network, click **Discover devices**.

Note

- The list shows all Axis devices that are found, not only devices that can be paired.
- An info icon is shown for devices that have already been paired. Hover over the icon to get information about pairings that are already active.
- Make sure the paired devices run the same AXIS OS version.

Important

- It's only possible to discover devices where Bonjour is enabled. To enable Bonjour for a device, open its web interface and go to **System > Network > Network discovery protocols**.

The web interface

To read about all the features and settings available in the web interface of devices with AXIS OS, go to *AXIS OS web interface help*.

Learn more

View area

A view area is a cropped part of the full view. You can stream and store view areas instead of the full view to minimize bandwidth and storage needs. If you enable PTZ for a view area, you can pan, tilt and zoom within it. By using view areas you can remove parts of the full view, for example, the sky.

Capture modes

What capture mode to choose depends on the requirements for the frame rate and resolution of the specific surveillance setup. For specifications about available capture modes, see the product's datasheet at axis.com.

Capture mode views

To select capture mode views for the device, go to **Video > Stream**.

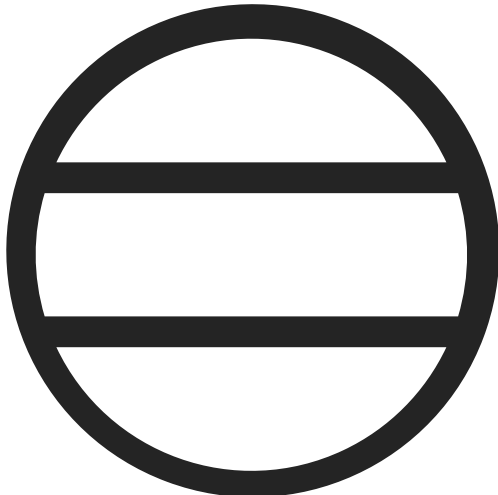
View	Symbol
Overview	
Panorama	

View Area 1-4







Corner Left

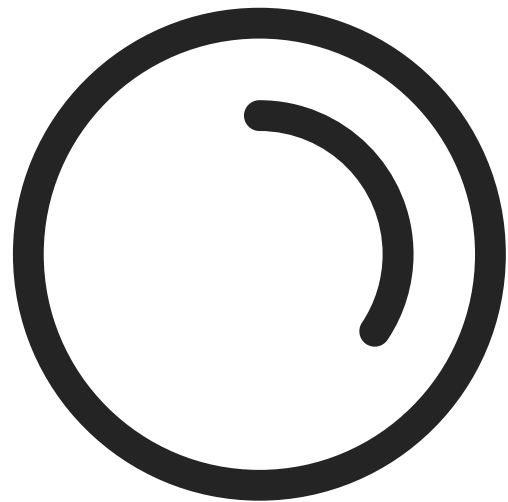

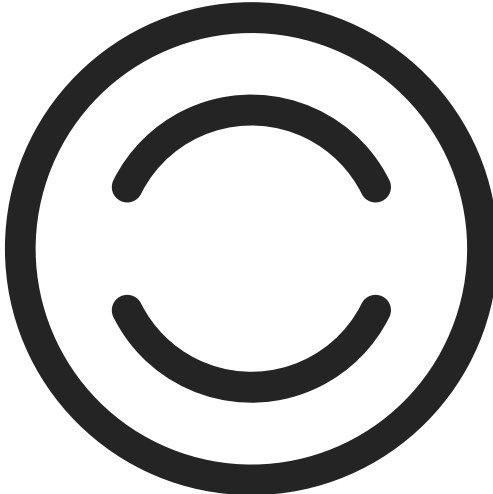
Corner Right



<p>Double Panorama</p>	
<p>Dual View</p>	
<p>Quad View</p>	

<p>Double Corner</p>	
<p>Corridor</p>	

Privacy masks

A privacy mask is a user-defined area that covers a part of the monitored area. In the video stream, privacy masks appear either as blocks of solid color or with a mosaic pattern.

You'll see the privacy mask on all snapshots, recorded video, and live streams.

You can use the VAPIX® application programming interface (API) to hide the privacy masks.

Important

If you use multiple privacy masks it may affect the product's performance.

You can create several privacy masks. Each mask can have 3 to 10 anchor points.

Overlays

Overlays are superimposed over the video stream. They are used to provide extra information during recordings, such as a timestamp, or during product installation and configuration. You can add either text or an image.

Note

Overlays are included in all video streams except SIP calls when the connection is over PoE class 3.

Streaming and storage

Video compression formats

Decide which compression method to use based on your viewing requirements, and on the properties of your network. The available options are:

Motion JPEG

Motion JPEG, or MJPEG, is a digital video sequence that is made up of a series of individual JPEG images. These images are then displayed and updated at a rate sufficient to create a stream that shows constantly updated motion. For the viewer to perceive motion video the rate must be at least 16 image frames per second. Full motion video is perceived at 30 (NTSC) or 25 (PAL) frames per second.

The Motion JPEG stream uses considerable amounts of bandwidth, but provides excellent image quality and access to every image contained in the stream.

H.264 or MPEG-4 Part 10/AVC

Note

H.264 is a licensed technology. The Axis product includes one H.264 viewing client license. To install additional unlicensed copies of the client is prohibited. To purchase additional licenses, contact your Axis reseller.

H.264 can, without compromising image quality, reduce the size of a digital video file by more than 80% compared to the Motion JPEG format and by as much as 50% compared to older MPEG formats. This means that less network bandwidth and storage space are required for a video file. Or seen another way, higher video quality can be achieved for a given bitrate.

H.265 or MPEG-H Part 2/HEVC

H.265 can, without compromising image quality, reduce the size of a digital video file by more than 25% compared to H.264.

Note

- H.265 is licensed technology. The Axis product includes one H.265 viewing client license. Installing additional unlicensed copies of the client is prohibited. To purchase additional licenses, contact your Axis reseller.
- Most web browsers don't support H.265 decoding and because of this the camera doesn't support it in its web interface. Instead you can use a video management system or application supporting H.265 decoding.

AV1

AV1 (AOMedia Video 1) is a license-free video coding format optimized for streaming media. AV1 enables high-quality video streaming even in bandwidth-constrained environments. By reducing a video's bitrate, AV1 preserves video quality while minimizing data usage.

AV1 supports all major browsers, computer operating systems and mobile platforms.

Note

AV1 requires more processing power for encoding and decoding compared to some other codecs.

How do Image, Stream, and Stream profile settings relate to each other?

The **Image** tab contains camera settings that affect all video streams from the product. If you change something in this tab, it immediately affects all video streams and recordings.

The **Stream** tab contains settings for video streams. You get these settings if you request a video stream from the product and don't specify for example resolution, or frame rate. When you change the settings in the **Stream** tab, it doesn't affect ongoing streams, but it will take effect when you start a new stream.

The **Stream profiles** settings override the settings from the **Stream** tab. If you request a stream with a specific stream profile, the stream contains the settings of that profile. If you request a stream without specifying a stream profile, or request a stream profile that doesn't exist in the product, the stream contains the settings from the **Stream** tab.

Bitrate control

Bitrate control helps you to manage the bandwidth consumption of your video stream.

Variable bitrate (VBR)

Variable bitrate allows the bandwidth consumption to vary depending on the level of activity in the scene. The more activity, the more bandwidth you need. With variable bitrate you are guaranteed constant image quality, but you need to make sure you have storage margins.

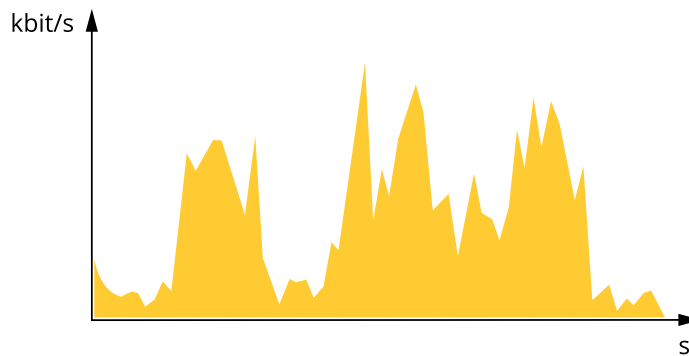

Maximum bitrate (MBR)

Maximum bitrate lets you set a target bitrate to handle bitrate limitations in your system. You might see a decline in image quality or frame rate as the instantaneous bitrate is kept below the specified target bitrate. You can choose to prioritize either image quality or frame rate. We recommend that you configure the target bitrate to a higher value than the expected bitrate. This gives you a margin in case there is a high level of activity in the scene.

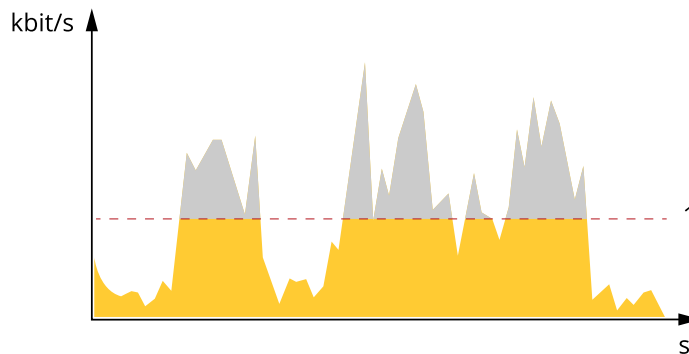

1 Target bitrate

Average bitrate (ABR)

With average bitrate, the bitrate is automatically adjusted over a longer period of time. This is so you can meet the specified target and provide the best video quality based on your available storage. Bitrate is higher in scenes with a lot of activity, compared to static scenes. You are more likely to get better image quality when in scenes with a lot of activity if you use the average bitrate option. You can define the total storage required to store the video stream for a specified amount of time (retention time) when image quality is adjusted to meet the specified target bitrate. Specify the average bitrate settings in one of the following ways:

- To calculate the estimated storage need, set the target bitrate and the retention time.

- To calculate the average bitrate, based on available storage and required retention time, use the target bitrate calculator.

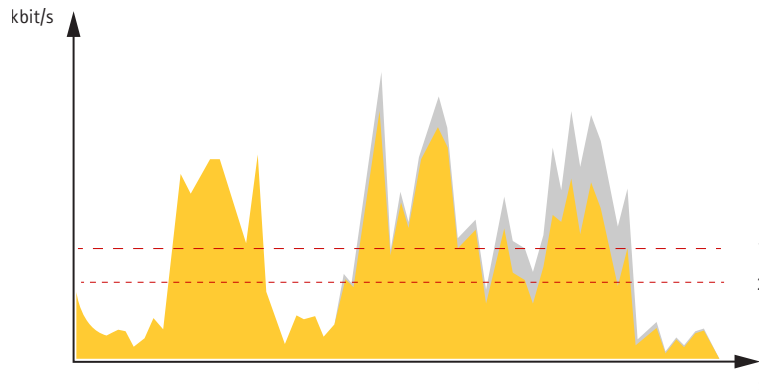

- 1 Target bitrate
- 2 Actual average bitrate

You can also turn on maximum bitrate and specify a target bitrate within the average bitrate option.

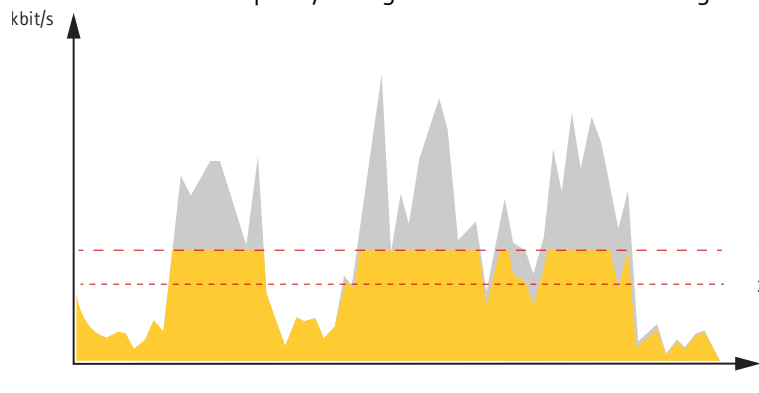

- 1 Target bitrate
- 2 Actual average bitrate

Edge-to-edge technology

Edge-to-edge is a technology that makes IP devices communicate directly with each other. It offers smart pairing functionality between, for example, Axis cameras and Axis audio or radar products.

Note

Make sure the paired devices run the same AXIS OS version.

For more information, see the white paper "Edge-to-edge technology" at whitepapers.axis.com/edge-to-edge-technology.

Speaker pairing

Edge-to-edge speaker pairing allows you to use a compatible Axis network speaker as if it's part of your camera. Once paired, the speaker's features are integrated in the camera's web interface and the network speaker acts as an audio out device where you can play audio clips and transmit sound through the camera.

The camera will identify itself to the VMS as a camera with integrated audio output and redirect any played audio to the speaker.

Network pairing

With edge-to-edge network pairing, you can connect your camera to a compatible Axis device with light and siren functionality and benefit from its integrated features.

Analytics and apps

With analytics and apps you can get more out of your Axis device. AXIS Camera Application Platform (ACAP) is an open platform that makes it possible for third parties to develop analytics and other apps for Axis devices. Apps can be preinstalled on the device, available for download for free, or for a license fee.

To find the user manuals for Axis analytics and apps, go to help.axis.com.

AXIS Object Analytics

AXIS Object Analytics is an analytic application that comes preinstalled on the camera. It detects objects that move in the scene and classifies them as, for example, humans or vehicles. You can set up the application to send alarms for different types of objects. To find out more about how the application works, see *AXIS Object Analytics user manual*.

Product specific considerations

For best results, the camera must be correctly mounted. There are also requirements on the scene, image and objects.

- Maximum recommended mounting height: 4 m (13.1 ft).
- Humans in the center of the image are less likely to be classified.
- Objects near the edge of the image appear smaller than objects near the center and are therefore less likely to be detected.

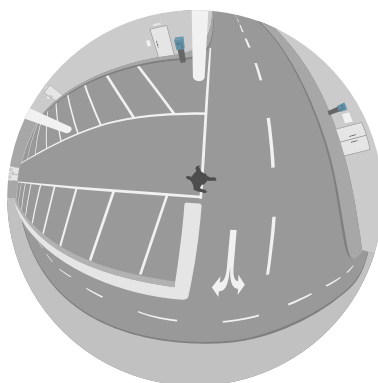

Object in the center

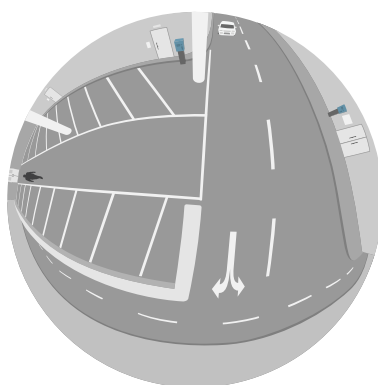

Objects at the edge

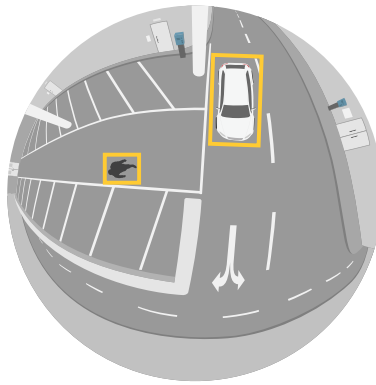

Objects near the center

AXIS Image Health Analytics

AXIS Image Health Analytics is an AI-based application that can be used to detect image degradations or tampering attempts. The application analyzes and learns the behavior of the scene to detect blurriness or underexposure in the image, or to detect an obstructed or redirected view. You can set up the application to send events for any of these detections, and trigger actions through the camera's event system or third-party software.

To find out more about how the application works, see *AXIS Image Health Analytics user manual*.

Metadata visualization

Analytics metadata is available for moving objects in the scene. Supported object classes are visualized in the video stream through a bounding box surrounding the object, along with information about the object type and confidence level of the classification. To learn more about how to configure and consume analytics metadata, see *AXIS Scene Metadata integration guide*.

Cybersecurity

For product-specific information about cybersecurity, see the product's datasheet at axis.com.

For in-depth information about cybersecurity in AXIS OS, read the *AXIS OS Hardening guide*.

Axis security notification service

Axis provides a notification service with information about vulnerability and other security related matters for Axis devices. To receive notifications, you can subscribe at axis.com/security-notification-service.

Vulnerability management

To minimize customers' risk of exposure, Axis, as a **Common Vulnerability and Exposures (CVE) numbering authority (CNA)**, follows industry standards to manage and respond to discovered vulnerabilities in our devices, software, and services. For more information about Axis vulnerability management policy, how to report vulnerabilities, already disclosed vulnerabilities, and corresponding security advisories, see axis.com/vulnerability-management.

Secure operation of Axis devices

Axis devices with factory default settings are pre-configured with secure default protection mechanisms. We recommend using more security configuration when installing the device. To learn more about Axis' approach to cybersecurity, including best practices, resources, and guidelines for securing your devices, go to axis.com/about-axis/cybersecurity.

Specifications

Product overview

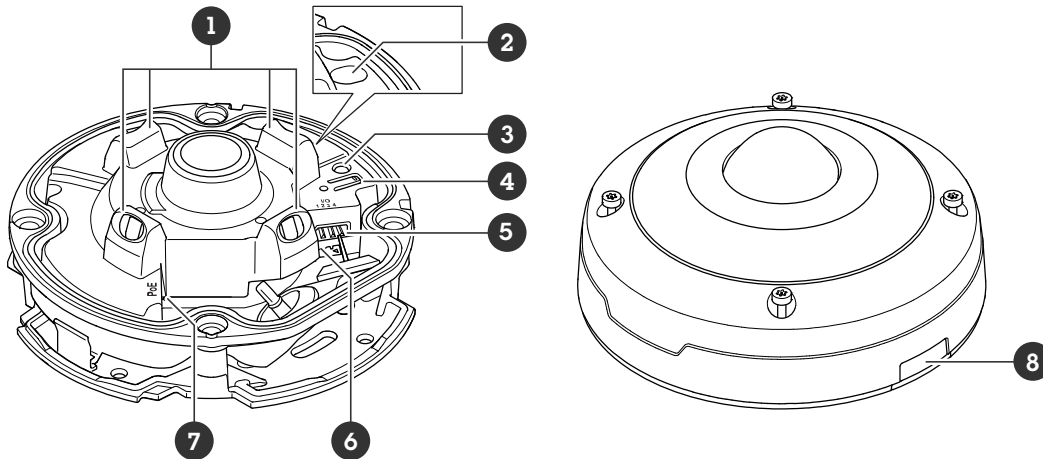

- 1 IR illumination x4
- 2 Intrusion alarm sensor
- 3 Status LED indicator
- 4 Control button
- 5 I/O connector
- 6 microSD card slot
- 7 Network connector, PoE
- 8 Lid

LED indicators

Status LED	Indication
Unlit	Connection and normal operation.
Green	Shows steady green for 10 seconds for normal operation after startup completed.
Amber	Steady during startup. Flashes during device software upgrade or reset to factory default.
Amber/Red	Flashes amber/red if network connection is unavailable or lost.

SD card slot

NOTICE

- Risk of damage to SD card. Don't use sharp tools, metal objects, or excessive force when inserting or removing the SD card. Use your fingers to insert and remove the card.
- Risk of data loss and corrupted recordings. Unmount the SD card from the device's web interface before removing it. Don't remove the SD card while the product is running.

This device supports microSD/microSDHC/microSDXC cards.

For SD card recommendations, see axis.com.

 microSD, microSDHC, and microSDXC Logos are trademarks of SD-3C LLC. microSD, microSDHC, microSDXC are trademarks or registered trademarks of SD-3C, LLC in the United States, other countries or both.

Buttons

Control button

The control button is used for:

- Resetting the product to factory default settings. See *Reset to factory default settings, on page 36*.

Intrusion alarm sensor

The intrusion alarm sensor make sure you get a notification when someone opens the device's casing. Create a rule to make the device perform the action. See *Trigger a notification when the enclosure is opened, on page 19*.

Connectors

Network connector

RJ45 Ethernet connector with Power over Ethernet (PoE).

I/O connector

Use the I/O connector with external devices in combination with, for example, motion detection, event triggering, and alarm notifications. In addition to the 0 VDC reference point and power (12 V DC output), the I/O connector provides the interface to:

Digital input – For connecting devices that can toggle between an open and closed circuit, for example PIR sensors, door/window contacts, and glass break detectors.

Supervised input – Enables possibility to detect tampering on a digital input.

Digital output – For connecting external devices such as relays and LEDs. Connected devices can be activated by the VAPIX® Application Programming Interface, through an event or from the device's web interface.

4-pin terminal block

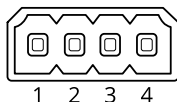

Function	Pin	Notes	Specifications
DC ground	1		0 VDC
DC output	2	 Can be used to power auxiliary equipment. Note: This pin can only be used as power out.	12 VDC Max load = 50 mA
Configurable (Input or Output)	3-4	Digital input or Supervised input – Connect to pin 1 to activate, or leave floating (unconnected) to deactivate. To use supervised input, install end-of-line resistors. See connection diagram for information about how to connect the resistors.	0 to max 30 VDC
		Digital output – Internally connected to pin 1 (DC ground) when active, and floating (unconnected) when inactive. If used with an inductive load, e.g., a relay, connect a diode in parallel with the load, to protect against voltage transients.	0 to max 30 VDC, open drain, 100 mA

Example:

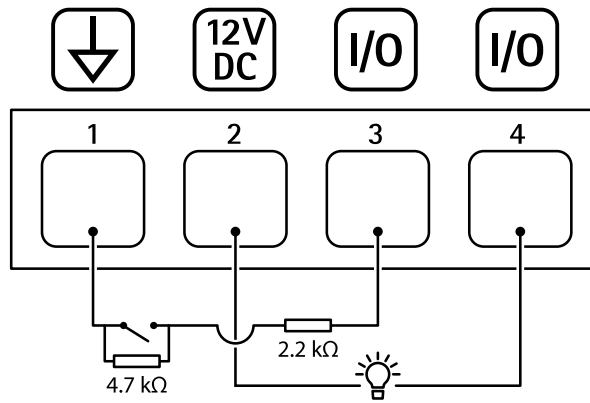

- 1 DC ground
- 2 DC output 12 V, max 50 mA
- 3 I/O configured as supervised input
- 4 I/O configured as output

Clean your device

You can clean your device with lukewarm water.

NOTICE

- Harsh chemicals can damage the device. Don't use chemicals such as window cleaner or acetone to clean your device.
 - Avoid cleaning in direct sunlight or elevated temperatures, since this can cause stains.
1. Use a can of compressed air to remove dust and loose dirt from the device.
 2. If necessary, clean the device with a soft microfiber cloth dampened with lukewarm water.
 3. To avoid stains, dry the device with a clean, nonabrasive cloth.

For more information about cleaning of Axis devices, see the white paper *Chemical resistance to common cleaning agents*.

Troubleshooting

Reset to factory default settings

▲ WARNING

⚠ Possibly hazardous optical radiation is emitted from this product. It can be harmful to the eyes. Don't stare at the operating lamp.

Important

Reset to factory default should be used with caution. A reset to factory default resets all settings, including the IP address, to the factory default values.

To reset the product to the factory default settings:

1. Disconnect power from the product.
2. Press and hold the control button while reconnecting power. See *Product overview, on page 32*.
3. Keep the control button pressed for 15–30 seconds until the status LED indicator flashes amber.
4. Release the control button. The process is complete when the status LED indicator turns green. If no DHCP server is available on the network, the device IP address will default to one of the following:
 - Devices with **AXIS OS 12.0 and later**: Obtained from the link-local address subnet (169.254.0.0/16)
 - Devices with **AXIS OS 11.11 and earlier**: 192.168.0.90/24
5. Use the installation and management software tools to assign an IP address, set the password, and access the device.
The installation and management software tools are available from the support pages on axis.com/support.

You can also reset parameters to factory default through the device's web interface. Go to **Maintenance > Factory default** and click **Default**.

AXIS OS options

Axis offers device software management according to either the active track or the long-term support (LTS) tracks. Being on the active track means continuously getting access to all the latest product features, while the LTS tracks provide a fixed platform with periodic releases focused mainly on bug fixes and security updates.

Using AXIS OS from the active track is recommended if you want to access the newest features, or if you use Axis end-to-end system offerings. The LTS tracks are recommended if you use third-party integrations, which are not continuously validated against the latest active track. With LTS, the products can maintain cybersecurity without introducing any significant functional changes or affecting any existing integrations. For more detailed information about Axis device software strategy, go to axis.com/support/device-software.

Check the current AXIS OS version

AXIS OS determines the functionality of our devices. When you troubleshoot a problem, we recommend that you to start by checking the current AXIS OS version. The latest version might contain a correction that fixes your particular problem.

To check the current AXIS OS version:

1. Go to the device's web interface > **Status**.
2. Under **Device info**, see the AXIS OS version.

Upgrade AXIS OS

Important

- When you upgrade the device software, your preconfigured and customized settings are saved. Axis Communications AB can't guarantee that the settings are saved, even if the features are available in the new AXIS OS version.
- Starting from AXIS OS 12.6, you must install every LTS version between your device's current version and the target version. For example, if the currently installed device software version is AXIS OS 11.2, you have to install the LTS version AXIS OS 11.11 before you can upgrade the device to AXIS OS 12.6. For more information, see *AXIS OS Lifecycle guide: Upgrade path*.
- Make sure the device remains connected to the power source throughout the upgrade process.

Note

- When you upgrade the device with the latest AXIS OS version in the active track, the product receives the latest functionality available. Always read the upgrade instructions and release notes available with each new release before you upgrade. To find the latest AXIS OS version and the release notes, go to axis.com/support/device-software.
1. Download the AXIS OS file to your computer, available free of charge at axis.com/support/device-software.
 2. Log in to the device as an administrator.
 3. Go to **Maintenance > AXIS OS upgrade** and click **Upgrade**.

When the upgrade has finished, the product restarts automatically.

You can use AXIS Device Manager to upgrade multiple devices at the same time. Find out more at axis.com/products/axis-device-manager.

Technical problems and possible solutions

Problems upgrading AXIS OS

AXIS OS upgrade failed

If the upgrade fails, the device reloads the previous version. The most common reason is that the wrong AXIS OS file has been uploaded. Check that the name of the AXIS OS file corresponds to your device and try again.

Problems after AXIS OS upgrade

If you experience problems after the upgrade, roll back to the previously installed version from the **Maintenance** page.

Problems setting the IP address

Can't set the IP address

- If the IP address intended for the device and the IP address of the computer used to access the device are located on different subnets, you can't set the IP address. Contact your network administrator to obtain an IP address.
- The IP address could be in use by another device. To check:
 1. Disconnect the Axis device from the network.
 2. In a Command/DOS window, type `ping` and the IP address of the device.
 3. If you receive: `Reply from <IP address>: bytes=32; time=10...` this means that the IP address might already be in use by another device on the network. Obtain a new IP address from the network administrator and reinstall the device.
 4. If you receive: `Request timed out`, this means that the IP address is available for use with the Axis device. Check all cabling and reinstall the device.
- There could be a possible IP address conflict with another device on the same subnet. The static IP address in the Axis device is used before the DHCP server sets a dynamic address. This means that if the same default static IP address is also used by another device, there could be problems accessing the device.

Problems accessing the device

Can't log in when accessing the device from a browser

When HTTPS is enabled, make sure that you use the correct protocol (HTTP or HTTPS) when you try to log in. You might need to manually type `http` or `https` in the browser's address field.

If you've lost the password for the root account, you must reset the device to the factory default settings. For instructions, see *Reset to factory default settings, on page 36*.

The IP address has been changed by DHCP

IP addresses obtained from a DHCP server are dynamic and could change. If the IP address has been changed, use AXIS IP Utility or AXIS Device Manager to locate the device on the network. Identify the device using its model or serial number, or by the DNS name (if the name has been configured).

If required, you can assign a static IP address manually. For instructions, go to axis.com/support.

Certificate error when using IEEE 802.1X

For authentication to work properly, the date and time settings in the Axis device must be synchronized with an NTP server. Go to **System > Date and time**.

The browser isn't supported

For a list of recommended browsers, see *Browser support, on page 5*.

Can't access the device externally

To access the device externally, we recommend you to use one of the following applications for Windows®:

- AXIS Camera Station Edge: free of charge, ideal for small systems with basic surveillance needs.
- AXIS Camera Station Pro: 90-day trial version free of charge, ideal for small to mid-size systems.

For instructions and download, go to axis.com/vms.

Problems with streaming

Multicast H.264 only accessible by local clients

Check if your router supports multicasting, or if you need to configure the router settings between the client and the device. You might need to increase the TTL (Time To Live) value.

No multicast H.264 displayed in the client

Check with your network administrator that the multicast addresses used by the Axis device are valid for your network.

Check with your network administrator to see if there is a firewall that prevents viewing.

Poor rendering of H.264 images

Ensure that your graphics card uses the latest driver. You can usually download the latest drivers from the manufacturer's website.

Color saturation is different in H.264 and Motion JPEG

Modify the settings for your graphics adapter. Check the adapter's documentation for more information.

Lower frame rate than expected

- See *Performance considerations, on page 40*.
- Reduce the number of applications running on the client computer.
- Limit the number of simultaneous viewers.
- Check with the network administrator that there is enough bandwidth available.
- Lower the image resolution.

Can't select H.265 encoding in live view

Web browsers don't support H.265 decoding. Use a video management system or application that supports H.265 decoding.

Problems with MQTT

Can't connect over port 8883 with MQTT over SSL

The firewall blocks traffic that uses port 8883 since it's regarded insecure.

In some cases the server/broker might not provide a specific port for MQTT communication. It might still be possible to use MQTT over a port normally used for HTTP/HTTPS traffic.

- If the server/broker supports WebSocket/WebSocket Secure (WS/WSS), typically on port 443, use this protocol instead. Check with the server/broker provider to see if WS/WSS is supported and which port and basepath to use.
- If the server/broker supports ALPN, the use of MQTT can be negotiated over an open port, such as 443. Check with your server/broker provider to see if ALPN is supported and which ALPN protocol and port to use.

If you can't find what you're looking for here, try the troubleshooting section at axis.com/support.

Performance considerations

When you set up your system, it's important to consider how different settings and situations affect performance. Some factors affect bandwidth (bitrate), others affect frame rate, and some affect both.

The most important factors to consider:

- High image resolution or lower compression levels result in images containing more data which in turn affects the bandwidth.
- Rotating the image in the GUI can increase the product's CPU load.
- Access by large numbers of Motion JPEG clients or unicast H.264/H.265/AV1 clients affects the bandwidth.
- Simultaneous viewing of different streams (resolution, compression) by different clients affects both frame rate and bandwidth.
Use identical streams wherever possible to maintain a high frame rate. Stream profiles can be used to ensure that streams are identical.
- Accessing video streams with different codecs simultaneously affects both frame rate and bandwidth. For optimal performance, use streams with the same codec.
- Heavy usage of event settings affects the product's CPU load which in turn affects the frame rate.
- Using HTTPS may reduce frame rate, in particular if streaming Motion JPEG.
- Heavy network utilization due to poor infrastructure affects the bandwidth.
- Viewing on poorly performing client computers lowers perceived performance and affects frame rate.
- Running multiple AXIS Camera Application Platform (ACAP) applications simultaneously may affect the frame rate and the general performance.

Contact support

If you need more help, go to axis.com/support.

T10233730

2026-06 (M2.2)

© 2026 Axis Communications AB