



Sarix TI Series Camera



User Manual



C6622M

September 2019

Pelco Troubleshooting Contact Information

If the instructions provided fail to solve your problem, contact Pelco Product Support at 1-800-289-9100 (USA and Canada) or +1-559-292-1981 (international) for assistance. Be sure to have the serial number available when calling.

Do not try to repair the unit yourself. Leave maintenance and repairs to qualified technical personnel only.



List of Revisions

No.	Date	Description	Page Number
1.0		New Release	All

Table of Contents

1. Important Notices	1-8
1.1 Regulatory Notices [FCC Class A]	1-8
1.1.1 Radio and Television Interference	1-8
1.2 Legal Notice [Audio Notice]	1-8
1.3 Video Quality Caution	1-9
1.3.1 Frame Rate Notice Regarding User Selected Options	1-9
1.4 Open Source Software	1-9
1.5 CCC Power Cord Statement	1-9
1.5.1 2.4 GHZ Radio Device	1-10
1.6 ESD Warning	1-10
1.7 Warranty	1-10
1.8 Network Topology Statement	1-10
2. Overview	2-13
2.1 Overview	2-14
2.2 Features	2-14
2.3 Physical Description of the Camera	2-15
2.4 Marking	2-16
2.5 Sarix TI Web GUI	2-17
2.6 Technical Data and Specifications	2-18
2.6.1 System Specifications	2-18
2.6.2 Configurations	2-19
2.6.3 Thermal Camera	2-20
2.6.4 CMOS Camera	2-20
3. Safety	3-1
3.1 Safety Conventions	3-1
3.2 Safety During Installation	3-2
3.3 Safety During Maintenance	3-2
4. Installation	4-1
4.1 Unpacking	4-1
4.2 Camera Installation	4-2
4.2.1 Installation Guidelines and Preparation	4-2
4.2.2 Mechanical Interface Preparation	4-3
4.2.3 Wall Mount Configuration	4-4
4.2.4 Pole Mount Configuration	4-5
4.2.5 Electrical ICD IP PoE Cable	4-6
5. Operation	5-1
5.1 First Time Credentials Setup	5-2

5.2	Logging Into Sarix TI Camera Web GUI.....	5-3
5.3	Changing Your Password.....	5-5
5.4	Main Window Overview	5-6
5.5	Live View Window	5-7
5.6	Status Window.....	5-8
5.6.1	System Tab.....	5-9
5.6.2	Thermal Tab.....	5-10
5.6.3	Day Tab.....	5-12
5.6.4	Disabling / Enabling a Camera	5-13
5.7	Network Window	5-15
5.7.1	Setting of IP Address	5-16
5.7.2	Setting an Auto IP Address (DHCP).....	5-16
5.7.3	Setting a Manual DNS Server Address.....	5-17
5.7.4	Settings of HTTPS Connection.....	5-17
5.7.5	Setting the Network Interface	5-17
5.7.6	Resetting Network Settings.....	5-18
5.7.7	Restarting ONVIF Service	5-18
5.7.8	Certificates	5-19
5.8	Streaming Window.....	5-21
5.8.1	Thermal Tab.....	5-21
5.8.2	Day Tab.....	5-25
5.8.3	General Configuration Tab	5-28
5.9	Image Processing Window	5-29
5.9.1	Thermal Tab.....	5-29
5.9.2	Day Tab.....	5-37
5.10	Analytics Window	5-41
5.10.1	Regions Tab	5-42
5.10.2	Ignore Regions Tab.....	5-46
5.10.3	Learning Tab.....	5-48
5.10.4	Analytics Settings.....	5-49
5.11	System Window.....	5-51
5.11.1	Admin Tab	5-51
5.11.2	Logs Tab.....	5-57
5.11.3	Date and Time Tab.....	5-58
5.11.4	File Upload Tab.....	5-60
5.11.5	User Management Tab	5-60
5.12	Logging Out from the Web GUI	5-62
6.	Maintenance	6-63
6.1	Visual Inspection	6-63
6.2	Cleaning.....	6-63
7.	Ordering Information	7-64

7.1	Ordering Information	7-64
7.2	Ordering Accessories	7-64
8.	Index.....	8-65

List of Figures

Figure 2-1:	Sarix TI Camera General View	2-14
Figure 2-2:	Physical Description of the Camera	2-15
Figure 2-3:	Sarix TI Label.....	2-16
Figure 2-4:	Sarix TI Web GUI	2-17
Figure 4-1:	Sarix TI Camera Package General View	4-1
Figure 4-2:	Mechanical Interface Preparation - Camera Dimensions.....	4-3
Figure 4-3:	Camera Installation - Wall Mount Configuration	4-4
Figure 4-4:	Camera Installation - Pole Mount Configuration	4-5
Figure 4-5:	Electrical ICD IP PoE Cable	4-6
Figure 5-1:	Sarix TI Web GUI – First Time Setup	5-2
Figure 5-2:	Sarix TI Web GUI - Status Window (before Login).....	5-3
Figure 5-3:	Login Window.....	5-3
Figure 5-4:	Login Window – Entering Username and Password.....	5-4
Figure 5-5:	Sarix TI Web GUI - Status Window (after Login).....	5-4
Figure 5-6:	Changing Your Password - Drop Down Menu	5-5
Figure 5-7:	Sarix TI Web GUI - Changing Your Password.....	5-5
Figure 5-8:	Main Window Overview - Main Areas	5-6
Figure 5-9:	Live View Window (example).....	5-7
Figure 5-10:	Status Window (all collapsed).....	5-8
Figure 5-11:	Status Window - System Tab	5-9
Figure 5-12:	Status Window - Thermal Tab	5-10
Figure 5-13:	Status Window - Day Tab	5-12
Figure 5-14:	Disabling / Enabling a Camera - System Reboot.....	5-13
Figure 5-15:	Disabling / Enabling a Camera - System Reboot Approval.....	5-14
Figure 5-16:	Network Window - Basic Settings Tab.....	5-15
Figure 5-17:	Network Window - Changing an Address.....	5-16
Figure 5-18:	Network Window - Setting Network Interface	5-17
Figure 5-19:	Network Window - Resetting IP Address Approval	5-18
Figure 5-20:	Network Window - ONVIF Reload	5-18
Figure 5-21:	Certificates - Creating a Certificate Request.....	5-19
Figure 5-22:	Certificates - Generating a Self-Signed Certificate	5-19
Figure 5-23:	Certificates - Uploading a Certificate.....	5-20
Figure 5-24:	Streaming Window - Thermal Tab.....	5-21
Figure 5-25:	Streaming Window - Thermal Tab - Main Stream.....	5-22
Figure 5-26:	Streaming Window - Thermal Tab - Secondary Stream	5-24
Figure 5-27:	Streaming Window - Day Tab - Main Stream.....	5-25
Figure 5-28:	Streaming Window - Day Tab - Secondary Stream.....	5-27
Figure 5-29:	Streaming Window - General Configuration Tab	5-28
Figure 5-30:	Image Processing Window - Thermal Tab.....	5-29
Figure 5-31:	Image Processing Window - Thermal Tab - Basic Settings.....	5-30
Figure 5-32:	Image Processing Window - Thermal Tab - Signal Processing Settings	5-31

Figure 5-33:	Image Processing Window - Thermal Tab - Gain Control Settings	5-32
Figure 5-34:	Image Processing Window - Thermal Tab - Advanced Settings	5-33
Figure 5-35:	Image Processing Window - Thermal Tab - Color Processing Settings.....	5-34
Figure 5-36:	Image Processing Window - Histogram Calculation ROI (1 of 3).....	5-34
Figure 5-37:	Image Processing Window - Histogram Calculation ROI (2 of 3).....	5-35
Figure 5-38:	Image Processing Window - Histogram Calculation ROI (3 of 3).....	5-36
Figure 5-39:	Image Processing Window - Day Tab	5-37
Figure 5-40:	Image Processing Window - Day Tab - Geometry Settings	5-38
Figure 5-41:	Image Processing Window - Day Tab - Misc Properties Settings.....	5-39
Figure 5-42:	Analytics Window (all collapsed).....	5-41
Figure 5-43:	Analytics Window - Regions Tab.....	5-42
Figure 5-44:	Analytics Window - Regions Tab - Region Options	5-43
Figure 5-45:	Analytics Window - Regions Tab - Area ROI.....	5-45
Figure 5-46:	Analytics Window - Regions Tab - Fence ROI.....	5-45
Figure 5-47:	Analytics Window - Ignore Regions Tab	5-46
Figure 5-48:	Analytics Window - Ignore Regions Tab – Ignore Regions ROI (1 of 2).....	5-47
Figure 5-49:	Analytics Window - Ignore Regions Tab – Ignore Regions ROI (2 of 2).....	5-47
Figure 5-50:	Analytics Window - Learning Tab	5-48
Figure 5-51:	Analytics Window - Analytics Settings.....	5-49
Figure 5-52:	System Window - Admin Tab	5-51
Figure 5-53:	System Window - Admin Tab - Restart Approval	5-51
Figure 5-54:	System Window - Admin Tab - Restart.....	5-52
Figure 5-55:	System Window - Admin Tab - Archive System Files	5-52
Figure 5-56:	System Window - Admin Tab - Save As Site Approval	5-53
Figure 5-57:	System Window - Admin Tab - Save As Site	5-53
Figure 5-58:	System Window - Admin Tab - Export Site Approval.....	5-54
Figure 5-59:	System Window - Admin Tab - Site Defaults Approval.....	5-54
Figure 5-60:	System Window - Admin Tab - Site Defaults	5-55
Figure 5-61:	System Window - Admin Tab - Factory Defaults Approval	5-55
Figure 5-62:	System Window - Admin Tab - Factory Defaults	5-56
Figure 5-63:	System Window - Logs Tab	5-57
Figure 5-64:	System Window - Date and Time Tab.....	5-58
Figure 5-65:	System Window - Date and Time Tab - Synchronizing with Browser Time.....	5-59
Figure 5-66:	System Window - Date and Time Tab - Synchronizing with NTP	5-59
Figure 5-67:	System Window - File Upload Tab	5-60
Figure 5-68:	System Window - User Management Tab.....	5-60
Figure 5-69:	System Window - User Management Tab - Adding a User	5-61
Figure 5-70:	System Window - User Management Tab - Editing User Details	5-62
Figure 5-71:	Logging Out from the Web GUI - Drop Down Menu.....	5-62

List of Tables

Table 2-1:	Technical Data and Specifications - System Specifications.....	2-18
Table 2-2:	Technical Data and Specifications - Configurations	2-19
Table 2-3:	Technical Data and Specifications - Thermal Camera	2-20
Table 2-4:	Technical Data and Specifications - CMOS Camera	2-20
Table 4-1:	Electrical ICD IP PoE Cable - Pinout.....	4-6
Table 7-1:	Ordering Information for 30Hz Camera.....	7-64
Table 7-2:	Ordering Information for 9Hz Camera.....	7-64
Table 7-3:	Ordering Accessories.....	7-64

1. Important Notices

1.1 Regulatory Notices [FCC Class A]

This device complies with Part 15 of the FCC Rules. Operation is subject to the following two conditions:

(1) this device may not cause harmful interference, and (2) this device must accept any interference received, including interference that may cause undesired operation.

1.1.1 Radio and Television Interference

This equipment has been tested and found to comply with the limits of a Class A digital device, pursuant to Part 15 of the FCC rules. These limits are designed to provide reasonable protection against harmful interference when the equipment is operated in a commercial environment. This equipment generates, uses, and can radiate radio frequency energy and, if not installed and used in accordance with the instruction manual, may cause harmful interference to radio communications. Operation of this equipment in a residential area is likely to cause harmful interference in which case the user will be required to correct the interference at his own expense.

Changes and Modifications not expressly approved by the manufacturer or registrant of this equipment can void your authority to operate this equipment under Federal Communications Commission's rules.

To maintain compliance with FCC regulations shielded cables must be used with this equipment. Operation with non-approved equipment or unshielded cables is likely to result in interference to radio and television reception.

This Class A digital apparatus complies with Canadian ICES-003.

Cet appareil numérique de la classe A est conforme à la norme NMB-003 du Canada.

1.2 Legal Notice [Audio Notice]

SOME PELCO EQUIPMENT CONTAINS, AND THE SOFTWARE ENABLES, AUDIO/VISUAL AND RECORDING CAPABILITIES, THE IMPROPER USE OF WHICH MAY SUBJECT YOU TO CIVIL AND CRIMINAL PENALTIES. APPLICABLE LAWS REGARDING THE USE OF SUCH CAPABILITIES VARY BETWEEN JURISDICTIONS AND MAY REQUIRE, AMONG OTHER THINGS, EXPRESS WRITTEN CONSENT FROM RECORDED SUBJECTS. YOU ARE SOLELY RESPONSIBLE FOR INSURING STRICT COMPLIANCE WITH SUCH LAWS AND FOR STRICT ADHERENCE TO ANY/ALL RIGHTS OF PRIVACY AND PERSONALTY. USE OF THIS EQUIPMENT AND/OR SOFTWARE FOR ILLEGAL SURVEILLANCE OR MONITORING SHALL BE DEEMED UNAUTHORIZED USE IN VIOLATION OF THE END USER SOFTWARE

AGREEMENT AND RESULT IN THE IMMEDIATE TERMINATION OF YOUR LICENSE RIGHTS THEREUNDER.

1.3 Video Quality Caution

1.3.1 Frame Rate Notice Regarding User Selected Options

Pelco systems are capable of providing high quality video for both live viewing and playback. However, the systems can be used in lower quality modes, which can degrade picture quality, to allow for a slower rate of data transfer and to reduce the amount of video data stored. The picture quality can be degraded by either lowering the resolution, reducing the picture rate, or both. A picture degraded by having a reduced resolution may result in an image that is less clear or even indiscernible. A picture degraded by reducing the picture rate has fewer frames per second, which can result in images that appear to jump or move more quickly than normal during playback. Lower frame rates may result in a key event not being recorded by the system.

Judgment as to the suitability of the products for users' purposes is solely the users' responsibility. Users shall determine the suitability of the products for their own intended application, picture rate and picture quality. In the event users intend to use the video for evidentiary purposes in a judicial proceeding or otherwise, users should consult with their attorney regarding any particular requirements for such use.

1.4 Open Source Software

This product includes certain open source or other software originated from third parties that is subject to the GNU General Public License (GPL), GNU Library/Lesser General Public License (LGPL) and different and/or additional copyright licenses, disclaimers, and notices.

The exact terms of GPL, LGPL, and some other licenses are provided to you with this product. Please refer to the exact terms of the GPL and LGPL at <http://www.fsf.org> (Free Software Foundation) or <http://www.opensource.org> (Open Source Initiative) regarding your rights under said license. You may obtain a complete corresponding machine-readable copy of the source code of such software under the GPL or LGPL by sending your request to digitalsupport@pelco.com; the subject line should read Source Code Request. You will then receive an email with a link for you to download the source code.

This offer is valid for a period of three (3) years from the date of the distribution of this product by Pelco.

1.5 CCC Power Cord Statement

Models shipped to China do not include power cords.

NOTE

A CCC approved power cord must be used to power the equipment when used in China

1.5.1 2.4 GHZ Radio Device

해당무선설비기기는 운용 중 전파혼신가능성이 있으므로 인명안전과 관련된 서비스는 할 수 없습니다

1.6 ESD Warning



WARNING: This product is sensitive to Electrostatic Discharge (ESD). To avoid ESD damage to this product, use ESD safe practices during installation. Before touching, adjusting or handling this product, correctly attach an ESD wrist strap to your wrist and appropriately discharge your body and tools. For more information about ESD control and safe handling practices of electronics, please refer to ANSI/ESD S20.20-1999 or contact the Electrostatic Discharge Association (www.esda.org).

1.7 Warranty

For information about Pelco's product warranty and thereto related information, refer to www.pelco.com/warranty.

1.8 Network Topology Statement

IMPORTANT NOTE. PLEASE READ. The network implementation is shown as a general representation only and is not intended to show a detailed network topology. Your actual network will differ, requiring changes or perhaps additional network equipment to accommodate the system as illustrated. Please contact your local Pelco representative to discuss your specific requirements.

List of Acronyms and Abbreviations

AWG:	American Wire Gauge	NUC:	Non-Uniformity Correction
CBR:	Constant Bit Rate	NV:	Night Vision
Histogram:	Accurate representation of the distribution of numerical data.	ONVIF:	Open Network Video Interface Forum
CE:	Comminute European	P/N:	Part Number
CMOS:	Complementary Metal-Oxide Semiconductor	PoE:	Power Over Ethernet
DC:	Direct Current	QVGA+:	Quarter Video Graphics Array (384 × 288)
DFPA:	Digital Focal Plan Array	RH:	Relative Humidity
DHCP:	Dynamic Host Configuration Protocol	ROI:	Region Of Interest
DNS:	Domain Name System	RTN:	Return
FCC:	Federal Communications Commission	RTP:	Real Time Protocol
I-frame:	Infra-coded frame	RTSP:	Real-Time Streaming Protocol
FM:	Firmware	S/N:	Serial Number
FOV:	Field Of View	SDK:	Software Development Kit
FPS:	Frames Per Second	VMS:	Video Management System
GND:	Ground	SSL:	Secure Sockets Layer
GOP:	Group of Pictures	SW:	Software
GUI:	Graphical User Interface	TCP:	Transmission Control Protocol
HD:	High Definition	TINT:	Time Integration
HTTP:	Hypertexts Transfer Protocol	TLS:	Transport Layer Security
HTTPS:	HyperText Transfer Protocol Secure	URI:	Uniform Resource Indicator
IEEE:	Institute of Electrical and Electronics Engineers	V bus	CTIA reference voltage
IP:	Internet Protocol	VBR:	Variable Bit Rate
IR:	Infrared	VDC:	Volts, Direct Current
JPEG:	Joint Photographic Expert Group	VDDA:	Analog supply fixed
LAN:	Local Area Network	VGA:	Video Graphics Array (640 × 480)
MAC:	Media Access Control	VGSK:	Compensation microbolometer - transistor gate voltage
mK:	milli-Kelvin	WWW:	World Wide Web
NETD:	Noise Equivalent Temperature Difference	Pipeline:	data processing elements, connected in series, where the output of one element is the input of the next one.

Scope of This Manual

This manual provides the necessary information for introducing, installing, operating and maintaining the Sarix TI Series Camera.

The manual is intended for use by technicians and operators and consists of the following chapters:

- **Chapter 2: Overview:**
Introduces the Sarix TI Series Camera and its web GUI features.
- **Chapter 3: Safety:**
Provides safety instructions that technicians should be aware of during the installation, operation and maintenance of the Sarix TI Series Camera.
- **Chapter 4: Installation:**
Provides instructions for installing the Sarix TI Series Camera.
- **Chapter 5: Operation:**
Provides operating instructions for the Sarix TI Series Camera web GUI.
- **Chapter 6: Maintenance:**
Provides the Sarix TI Series Camera preventive maintenance instructions.
- **Chapter 7: Ordering Information:**
Provides information for purchasing the Sarix TI Series Camera and accessories.
- **Index:**
Provides a list, arranged in alphabetical order, of keywords found throughout this manual.

2. Overview

This chapter introduces the Sarix TI Series Camera and its web GUI features.

The chapter consists of the following sections:

- [Section 2.1: Overview](#)
- [Section 2.2: Features](#)
- [Section 2.3: Physical Description of the Camera](#)
- [Section 2.5: Sarix TI Web GUI](#)
- [Section 2.6: Technical Data and Specifications](#)

2.1 Overview

Sarix TI Camera is a state of the art observation system, boasting an incredibly easy installation with thermal and visual capabilities. The Sarix TI line of cameras is a broad portfolio of high performance outdoor rated cameras for 24/7 perimeter surveillance, observation, and monitoring of critical infrastructure and sensitive sites.

Equipped with thermal and visible-light channels, the Sarix TI meets global Open Network Video Interface Forum (ONVIF) standards to ensure interoperability of hardware and software products for easy integration to both existing and new infrastructures, regardless of manufacturer.

The Sarix TI is ruggedly designed to withstand the harshest weather and environmental conditions, including rain, direct sunlight, high humidity, dust, heat, and cold.

The Sarix TI uses new and innovative open uncooled 17μ 640 x 480 or 384 x 288 resolution thermal core and video enhancement algorithm.

Figure 2-1: Sarix TI Camera General View



2.2 Features

- Both visible and Video Graphics Array (VGA) thermal channels
- ONVIF Profile S compliant
- Easy installation
- Advanced optics
- Low cost of ownership
- Best support for analytics
- Rugged design
- Enhanced image processing

2.3 Physical Description of the Camera

The Sarix TI Camera outer components include (see [Figure 2-2](#)):

1. Infrared (IR) Camera Lens
2. Main Connector (Power and Ethernet)
3. Camera-to-Pole Mount Adapter fastening screws (x4)
4. Tripod mount fastening screw
5. Complementary Metal-Oxide Semiconductor (CMOS) Camera Lens (module depended).

Figure 2-2: Physical Description of the Camera

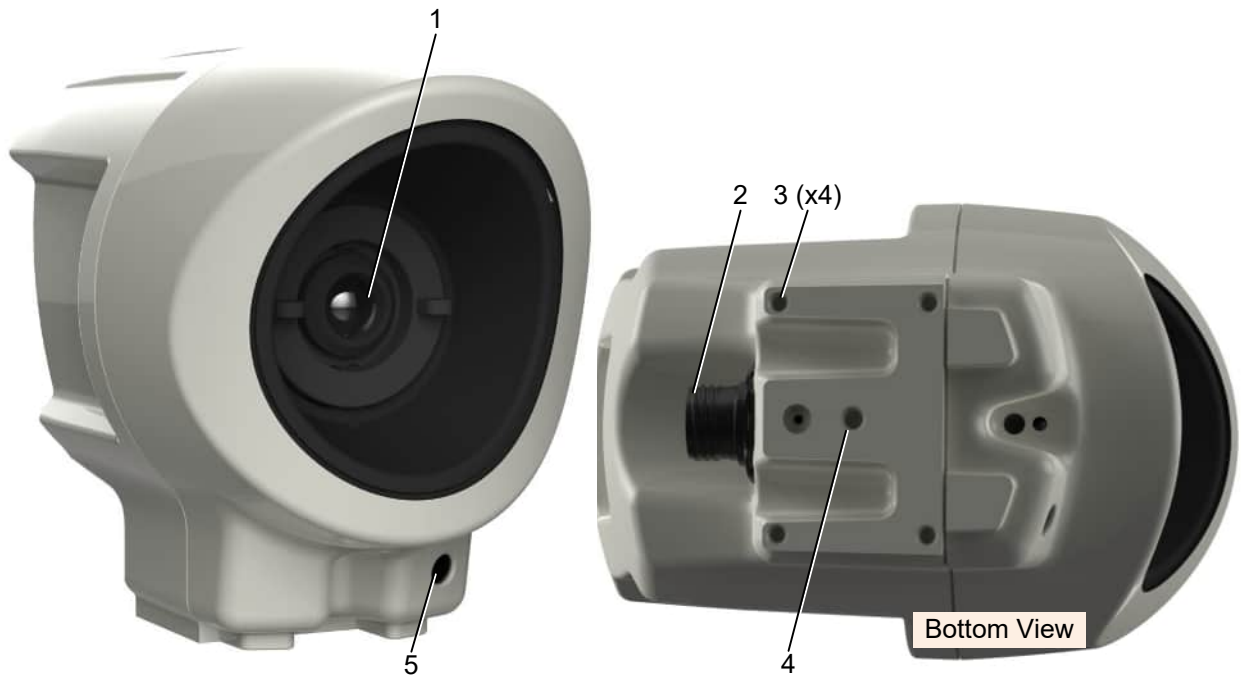

2.4 Marking

The camera us marked with a label as shown below:

Figure 2-3: Sarix TI Label



NOTE: For reference only

2.5 Sarix TI Web GUI

The operation of the Sarix TI Camera is performed via Web Graphical User Interface (GUI).

With the GUI you can:

- Setup the camera operation.
- Optimize the camera video.
- Communicate with Video Management Systems (VMS).

Figure 2-4: Sarix TI Web GUI

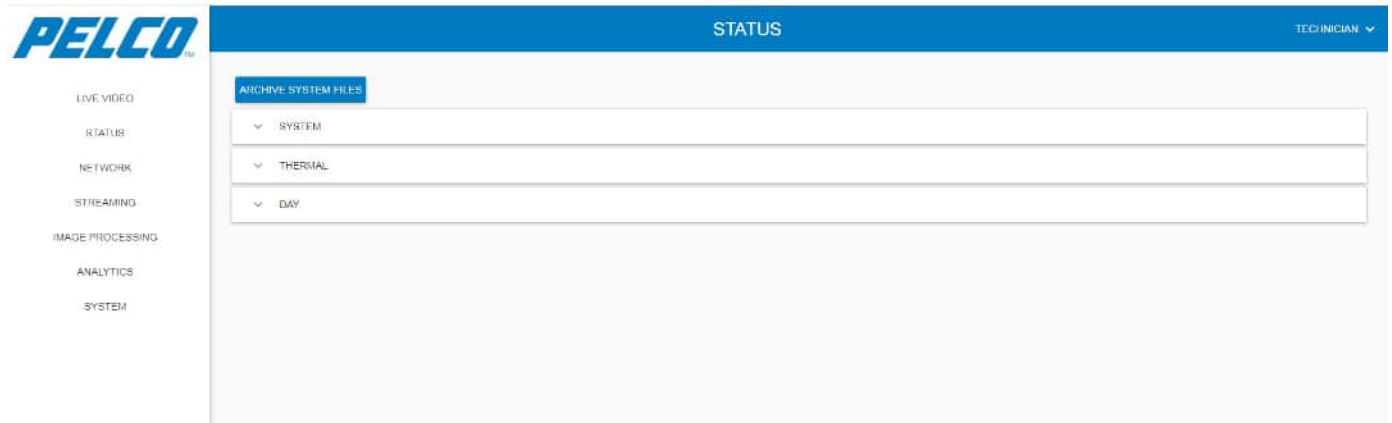

2.6 Technical Data and Specifications

2.6.1 System Specifications

Applicable to models :Sarix TI 14.2mm, 35mm, and 50mm.

Table 2-1: Technical Data and Specifications - System Specifications

Thermal Camera:	Imager Type:	Uncooled ASi Microbolometer
	Spectral Band:	7.5 - 14 μ
	Pixel Size:	17 μ
	Resolution:	640 x 480 (VGA) or 384 x 288 (QVGA)
	NETD:	VGA: < 40° mk, QVGA+: < 70° mk
Day Camera:	Imager Type:	¼" CMOS
	Resolutions:	640 x 480, 1024 x 768, or 1280 x 768
	Field of View:	54° (H) x 42° (V) @ 1024 x 768
	S/N Ratio:	36dB
Video:	Dual Channel:	2 channels IP video
	Compression:	H.264, Motion JPEG
	Frame Rate:	8.3Hz or 25Hz
	Streaming:	RTSP, Unicast, Multicast
	Image Settings:	Brightness, Sharpness, Contrast, Rotation: 0°, 90°, 180°, 270° Horizontal and Vertical Flip
Power Requirements:	Power Input:	12 - 32VDC or Power over Ethernet (IEEE 802.3af/802.3at)
	Consumption:	7W typical, 20W max. (based on DC voltage)
Environmental:	Storage Temp:	-40°C to +71°C (-40° F to +160° F)
	Operating Temp:	-40°C to +55°C (-40° F to +131° F)
	Humidity:	+40°C, 95% RH
	Rating:	IP66 (NEMA 4X equivalent)
Mechanical Parameters:	Dimensions:	- 135mm (w), 202mm (d), 169mm (h) - 5.32" (w), 7.95" (d), 6.65" (h)
	Weight:	- 14 and 35mm: 2.2kg, - 50mm: 2.4kg,
System Integration:	Interfaces:	ONVIF Profile S, Web GUI

Network:	Default IP:	192.168.0.20
	RTSP Port:	8554
	Protocols:	IPv4, HTTP, HTTPS, SSL/TLS, RTSP, DHCP
Certifications:	<ul style="list-style-type: none"> - CE - FCC - IP66 - UL and cUL 	EN 55032:12; EN 55024:2010+A1:2015; EN 50130-4:11+A1:14; EN 61000-3-2:14; EN 61000-3-3:13; EN 60950-1:06+A11:09+A1:10+A12:11+A2:13 UL 60950-1 2nd edition; CAN/CSA-C22.2 No. 60950-1:07+Amend 1:2011 IEC 60950-1:05+A1:09+A2:13; IEC 60950-22:16

2.6.2 Configurations

Table 2-2: Technical Data and Specifications - Configurations

	Day/Night	Day
Configuration Type	Thermal Camera & Lens	Camera & Lens
VGA	17 μ 640 x 480 Athermalized Uncooled Thermal	¼" Colour HD CMOS 1280 x 720 Autofocus
QVGA+	17 μ 384 x 288 Athermalized Uncooled Thermal	

2.6.3 Thermal Camera

Table 2-3: Technical Data and Specifications - Thermal Camera

Configuration	TI2X14	TI2X35	TI2X50
Thermal Type	Uncooled		
Thermal Core	17 μ 640 x 480 (VGA) or 17 μ 384 x 288 (QVGA+)		
Lens Type	Athermalized, Fixed Focus		
Focal Length	14.2mm	35mm	50mm
Lens F #	f/1.2	f/1.2	f/1.2
Horizontal FOV - VGA	42.1°	17.6°	12.4°
Horizontal FOV - QVGA+	25.7°	10.6°	7.5°
Video Type	H.264, Motion JPEG (25Hz or 9Hz)		
Spectral Band	Spectral Band 7.5 - 14 μ		
NETD	< 40° mk (VGA), < 70° mk (QVGA+)		
Digital Zoom	1x, 2x, 4x		
Control Operation	Polarity, NUC, Image Flip, Image Rotation & Digital Zoom		

2.6.4 CMOS Camera

Table 2-4: Technical Data and Specifications - CMOS Camera

Imager Type:	1/4" Colour HD CMOS
Effective Pixels / Resolutions:	640 x 480 or 1024 x 768 or 1280 x 720
Lens Type:	Autofocus
Imager FOV (H x V):	54° x 42°
S/N Ratio:	36dB
Additional Features:	Configurable Resolutions, Digital Zoom

3. Safety

This chapter provides safety instructions that technicians should be aware of during the installation, operation and maintenance of the Sarix TI Series Camera.

The chapter consists of the following sections:

- Section [3.1: Safety Conventions](#)
- Section [3.2: Safety During Installation](#)
- Section [3.3: Safety During Maintenance](#)

3.1 Safety Conventions

In this manual, safety information is presented as warnings, cautions, and notes.

WARNING

An operating procedure, practice, and so forth, which if not correctly followed, could result in personal injury or loss of life.

CAUTION

An operating procedure, practice, and so forth, which if not strictly observed, could result in damage to, or destruction of equipment.

NOTE

An operating procedure, practice, and so forth that is essential to highlight.

All procedures in this manual must be performed in accordance with the applicable local regulations.

All local safety regulations apply. If the instructions in any section of this manual contradict those of the applicable local regulations, the instructions of the applicable local regulations will prevail.

3.2 Safety During Installation

To avoid injuries, follow standard safety regulations if mounting the Sarix TI Camera on an elevated location.

3.3 Safety During Maintenance

- Warranty void if opening the Sarix TI camera.
- Do not touch the Sarix TI Camera optics with bare hands.
- Do not use any chemicals for cleaning the Sarix TI Camera. Use only wipes approved for optical equipment. Failure to comply could result in damage to the Sarix TI Camera optical-lens and/or its surfaces.

4. Installation

This chapter provides instructions for installing the Sarix TI Series Camera.

The chapter consists of the following sections:

- Section [4.1: Unpacking](#)
- Section [4.2: Camera Installation](#)

4.1 Unpacking

A standard package contains the following:

- Sarix TI Camera
- 18-pin round female cable-connector
- Ferrite
- Washer Lock
- Screw 6-32NCX1/4" SOC HD SS
- Terminal lug ring 16AWG stub size 6
- Package

Figure 4-1: Sarix TI Camera Package General View



4.2 Camera Installation

NOTE

Opening the Sarix TI Camera enclosure will void the product warranty.

CAUTION

Avoid pointing the Sarix TI Camera at the sun.

4.2.1 Installation Guidelines and Preparation

Prepare your self-made IP PoE cable (cables are available for purchase, see [Table 7-3](#) for information).

- 4.2.1.1 Cable wires between camera and DC/PoE power supply should be 20-22AWG.
- 4.2.1.2 Both the camera and the end-equipment connected to it should be permanently connected to protective earth, using screw and washers. Wires should be made of copper. Minimal grounding cable is 14AWG.
- 4.2.1.3 In case of using DC power supply:
 - (1) The cables should be protected by fuse with maximal current of 3A
 - (2) The output current shall not exceed 3A after 60s
 - (3) The maximal output current of the power supply shall not exceed 7.5A
- 4.2.1.4 Power supply (either POE injector or DC power supply) should be safety approved for local regulations.
- 4.2.1.5 Install the Ferrite on the operational cable as close as possible, max 5cm, from the system.

4.2.2 Mechanical Interface Preparation

NOTE

It is recommended to check the functioning of the Sarix TI Camera prior to the actual installation.

Figure 4-2 depicts the camera dimensions and mechanical interfaces.

Figure 4-2: Mechanical Interface Preparation - Camera Dimensions

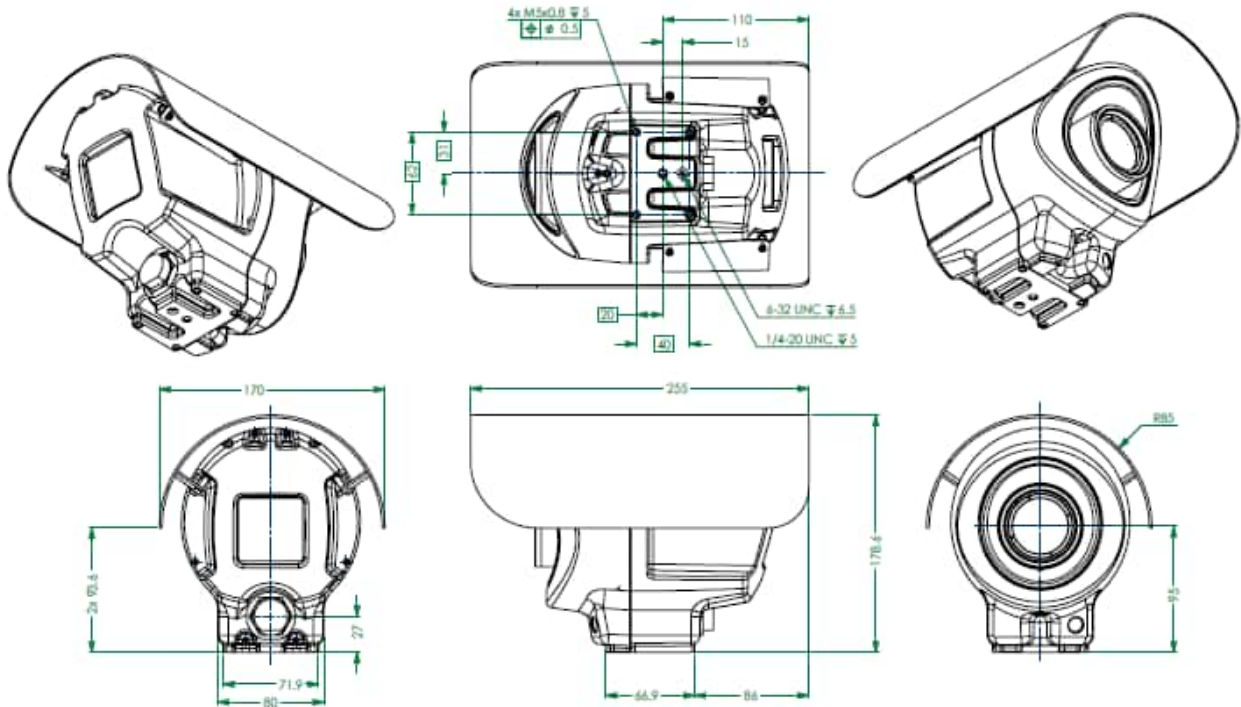

4.2.3 Wall Mount Configuration

An arm for wall-mount is available for purchase (see [Table 7-3](#) for information). The dimensions of the arm are given in [Figure 4-3](#):

Figure 4-3: Camera Installation - Wall Mount Configuration

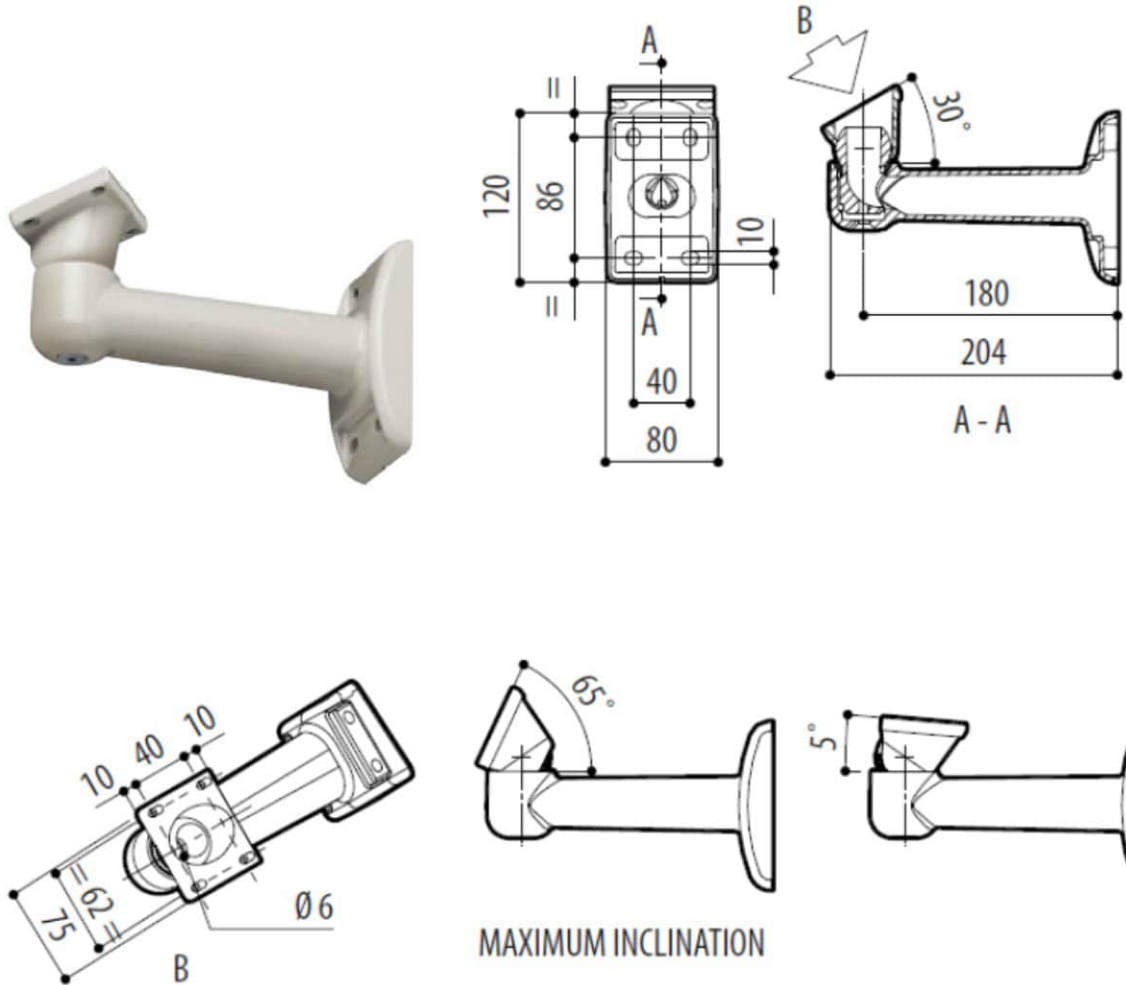

4.2.4 Pole Mount Configuration

An adapter for pole-mount is available for purchase (see [Table 7-3](#) for information).

The dimensions of the device are given in [Figure 4-4](#) (note that the arm for wall-mount is required, as well):

Figure 4-4: Camera Installation - Pole Mount Configuration

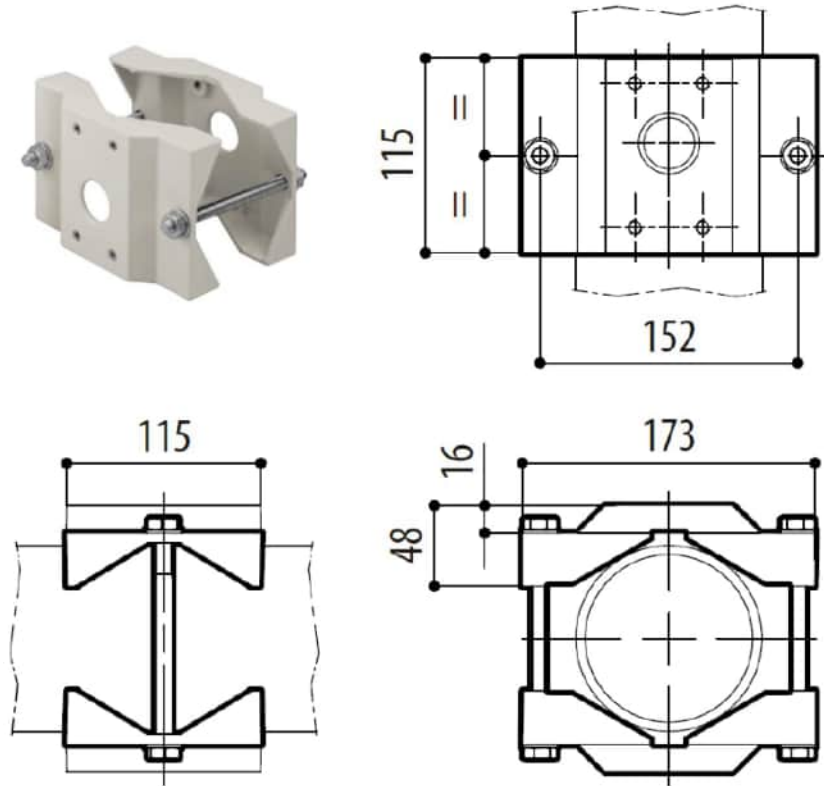

4.2.5 Electrical ICD IP PoE Cable

The cable is available for purchase (see [Table 7-3](#) for information).

Cable Pinout (see [Figure 4-5](#)):

Table 4-1: Electrical ICD IP PoE Cable - Pinout

	Connector Pin # P1	Connector Pin # P2 (RJ45)	Signal Name
Ethernet\POE	2	1	ETH RX+
	6	2	ETH RX-
	11	3	ETH TX+
	15	6	ETH TX-
	12	5,4	POE +
	14	7,8	POE -
DC Power Input	8	P.S (-)	12-32vDC RTN
	9	P.S (+)	12-32vDC
Shield	Camera body	GND Stud	Shield

Figure 4-5: Electrical ICD IP PoE Cable

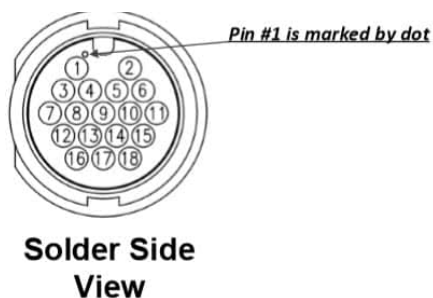
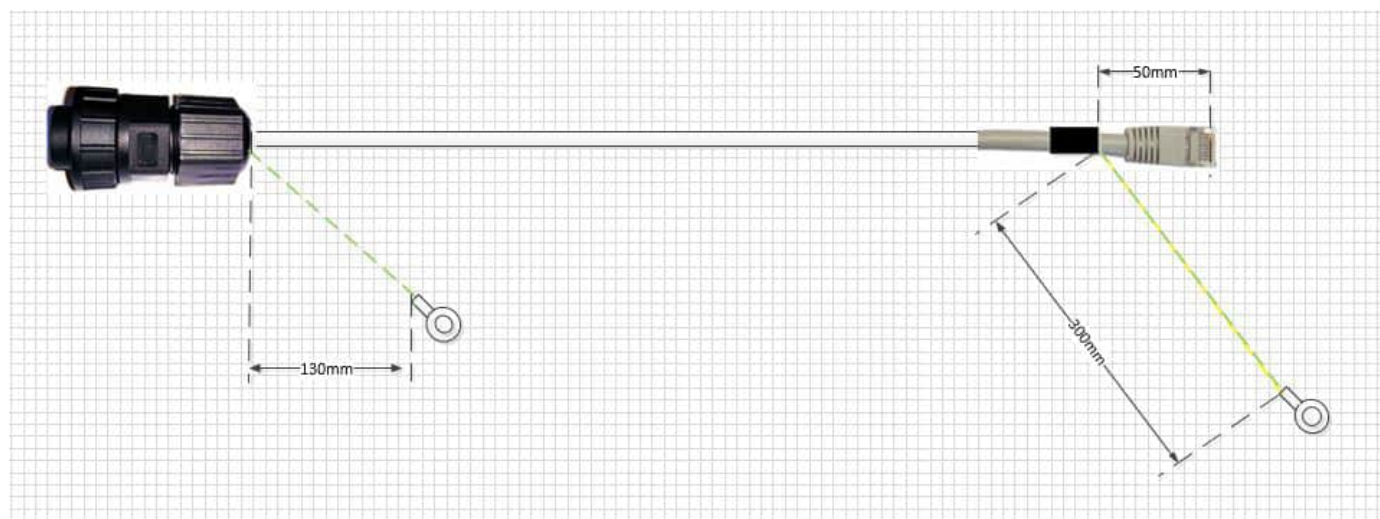

5. Operation

This chapter provides operating instructions for the Sarix TI Series Camera web GUI.

The chapter consists of the following sections:

- Section [5.1: First Time Credentials Setup](#)
- Section [5.2: Logging Into Sarix TI Camera Web GUI](#)
- Section [5.3: Changing Your Password](#)
- Section [5.4: Main Window Overview](#)
- Section [5.5: Live View Window](#)
- Section [5.6: Status Window](#)
- Section [5.7: Network Window](#)
- Section [5.8: Streaming Window](#)
- Section [5.9: Image Processing Window](#)
- Section [5.10: Analytics Window](#)
- Section [5.11: System Window](#)
- Section [5.12: Logging Out from the Web GUI](#)

5.1 First Time Credentials Setup

1. Open your web browser.
2. Type the Sarix TI Camera default IP address (**192.168.0.20**) in the address bar and click **Enter**. The **First Time Setup** window opens (example):

Figure 5-1: Sarix TI Web GUI – First Time Setup

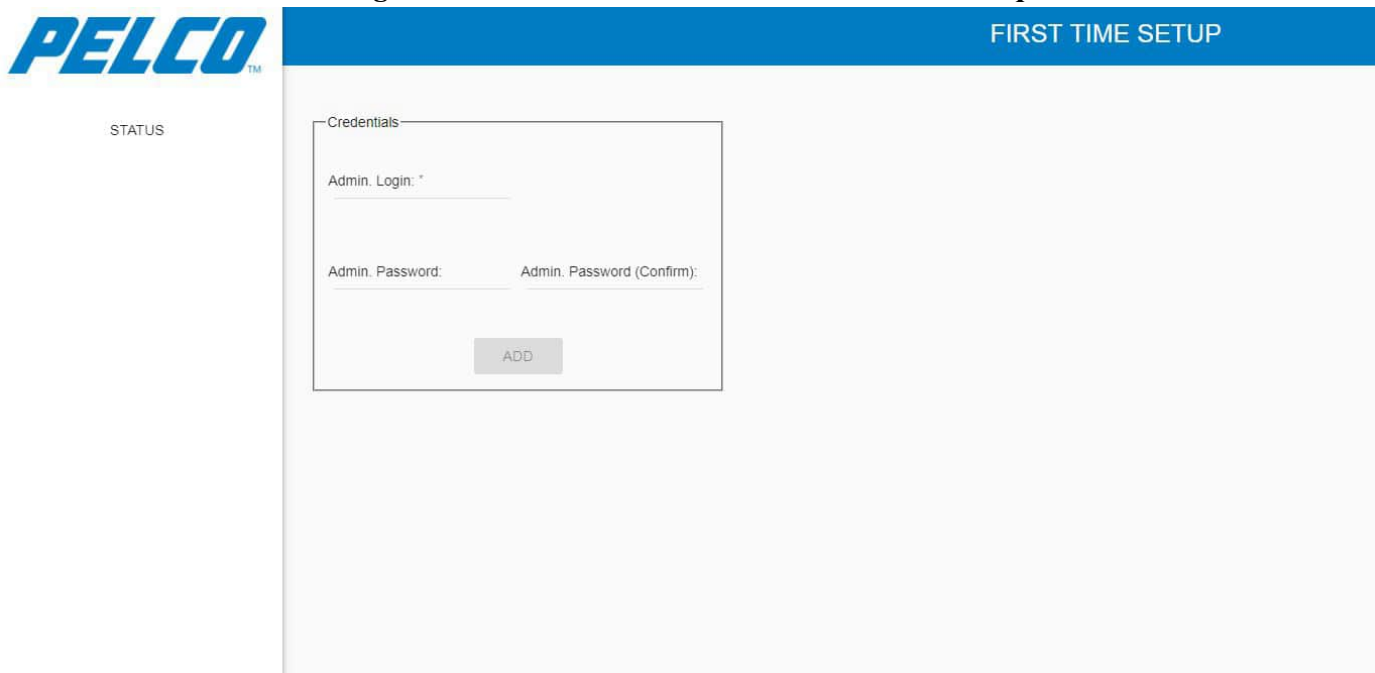

The screenshot shows the 'FIRST TIME SETUP' window of the Sarix TI Web GUI. The window features a blue header with the PELCO logo on the left and the text 'FIRST TIME SETUP' on the right. Below the header, there is a 'STATUS' label on the left. The main content area is titled 'Credentials' and contains three input fields: 'Admin. Login: *', 'Admin. Password:', and 'Admin. Password (Confirm):'. Below these fields is a grey 'ADD' button.

NOTE

The First Time Setup window appears the first time a user accesses the camera's IP address.

3. Define the administrator username in the **Admin Login** section.
4. Define the administrator password in the **Admin Password** section.
5. Retype the same password in the **Admin Password (confirm)** section.
6. Click **ADD**. The administrator credentials are defined.

NOTE

After defining the administrator credentials, the **Status** window opens (see Section [5.2](#)).

5.2 Logging Into Sarix TI Camera Web GUI

1. Open your web browser.
2. Type the Sarix TI Camera default IP address (**192.168.0.20**) in the address bar and click **Enter**. The **Status** window opens (example):

Figure 5-2: Sarix TI Web GUI - Status Window (before Login)

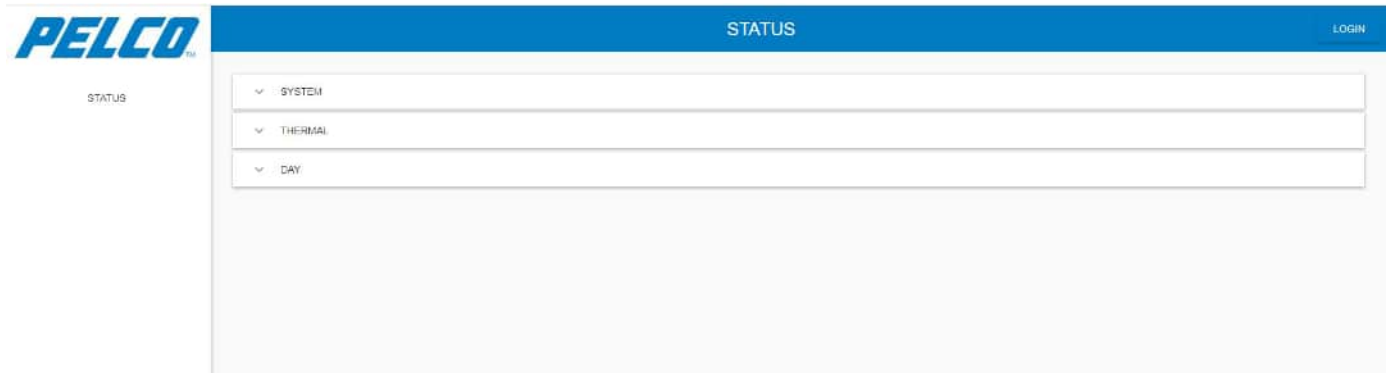

3. You may now view some default settings of your Sarix TI Camera by expanding the **System**, **Thermal** or **Day** tabs.
4. Click **LOGIN**. The Login window opens:

Figure 5-3: Login Window

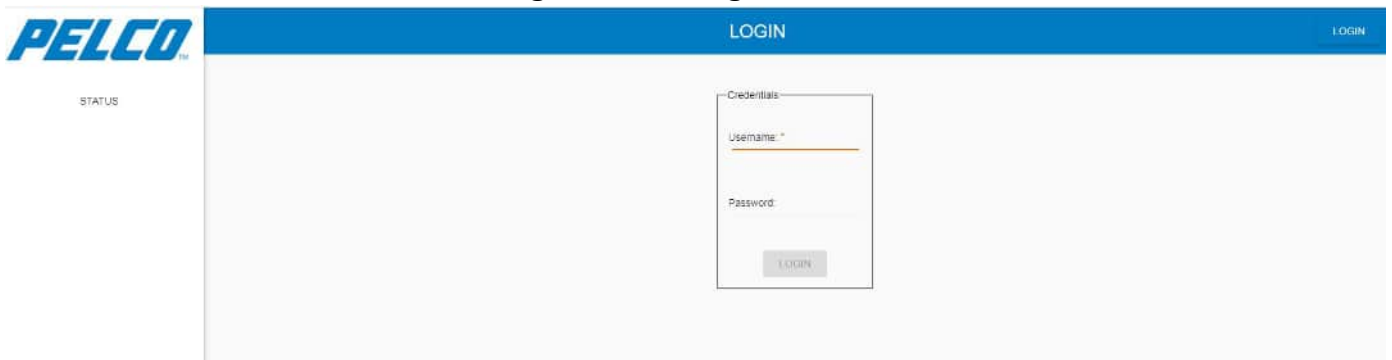

NOTE

A user is able to login only after they set up their credentials for the first time (see Section 5.1).

5. Enter your **Username** and **Password**:

Figure 5-4: Login Window – Entering Username and Password

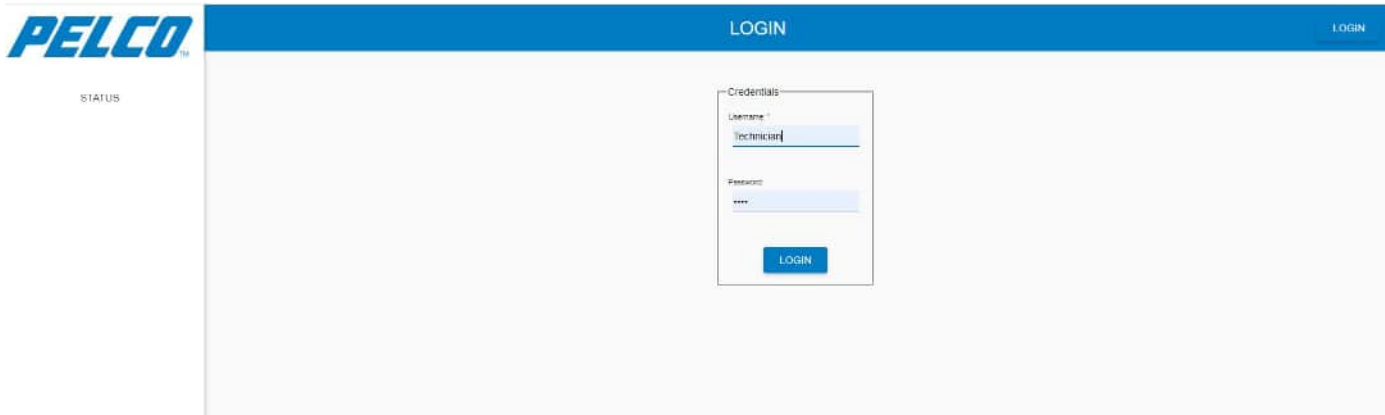

6. Click **LOGIN**. The following message is displayed on the lower-left corner of the screen for three seconds, stating that you have successfully logged in. In addition, the Status window opens:

You are successfully logged in. OK

Figure 5-5: Sarix TI Web GUI - Status Window (after Login)

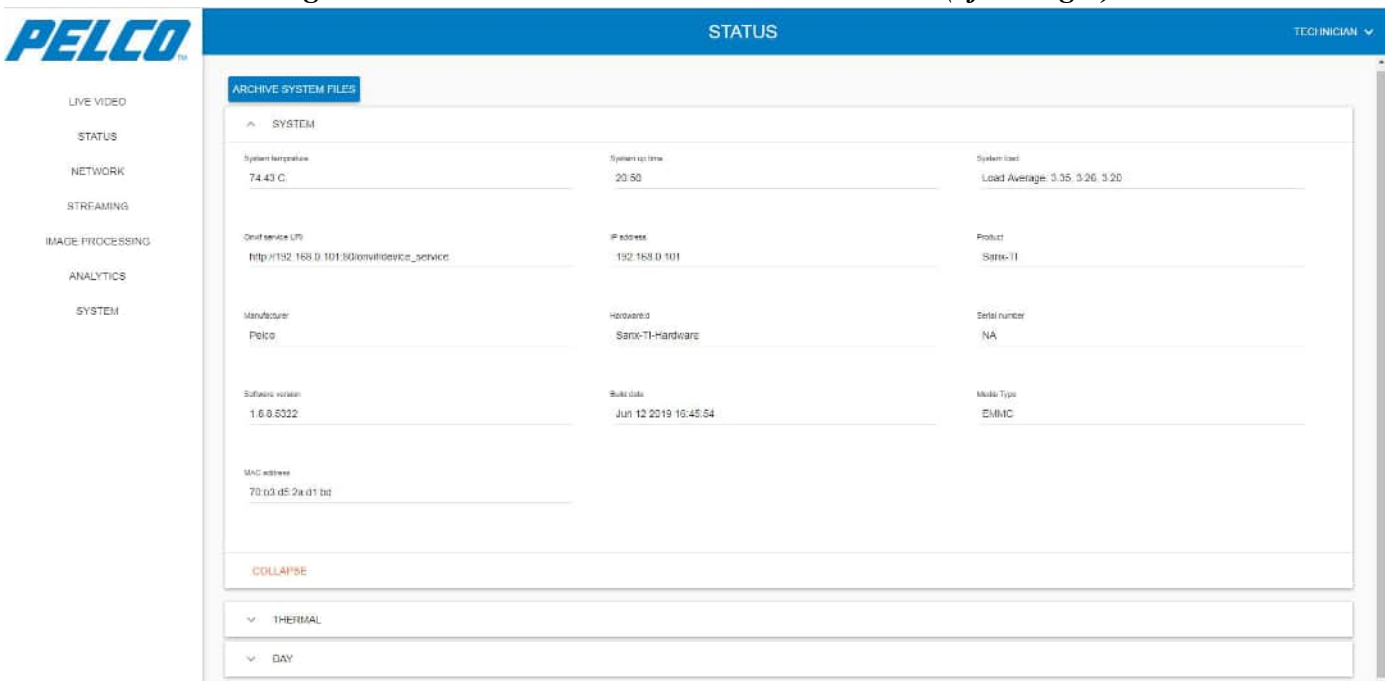

You can now use the Sarix TI Web GUI.

5.3 Changing Your Password

1. From the upper-right drop-down menu select **Change Password**:

Figure 5-6: Changing Your Password - Drop Down Menu

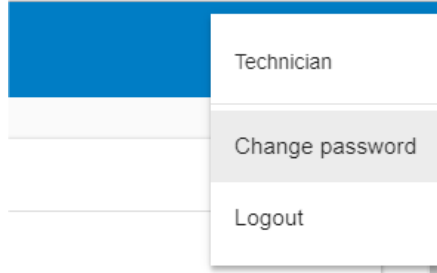

The following opens:

Figure 5-7: Sarix TI Web GUI - Changing Your Password

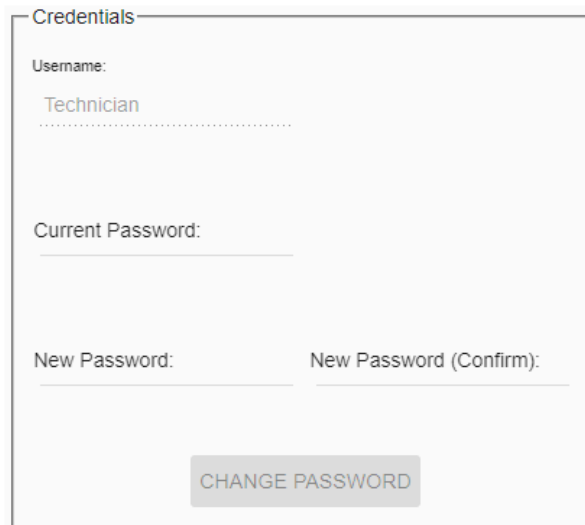
A screenshot of the 'Credentials' form in the Sarix TI Web GUI. The form contains the following fields: 'Username:' with the value 'Technician', 'Current Password:', 'New Password:', and 'New Password (Confirm):'. A 'CHANGE PASSWORD' button is located at the bottom of the form.

2. Enter your **Current Password**.
3. Enter the **New Password** and re-enter in the **New Password (Confirm)** field.
4. Click **CHANGE PASSWORD**. The system automatically logs out and the Login window reopen (see [Figure 5-3](#)).
5. Log in using the new password. The Status window re-opens (see [Figure 5-5](#)).

5.4 Main Window Overview

The main areas in every window consist of the following:

Figure 5-8: Main Window Overview - Main Areas

The screenshot displays the PELCO web interface. On the left is a vertical menu (1) with options: LIVE VIDEO, STATUS, NETWORK, STREAMING, IMAGE PROCESSING, ANALYTICS, and SYSTEM. The top header (2) contains the 'STATUS' tab and a 'TECHNICIAN' dropdown menu (3). The main content area (4) is titled 'ARCHIVE SYSTEM FILES' and shows system information for a 'SYSTEM' tab. The information is organized into three columns:

System temperature 31.36 C	System up time 10 min	System load Load Average: 0.25, 3.41, 2.02
Onvif service URI http://192.168.0.20:80/onvif/device_service	IP address 192.168.0.20	Product Sarix-TI
Manufacturer Pelco	Hardware ID Sarix-TI Hardware	Serial number NA
Software version 1.8.8.5614	Build date Sep 8 2015 05:50:47	Media Type EMMC
MAC address 70:03:00:2a:c1:b8		

Below the main content area, there are expandable sections for 'THERMAL' and 'DAY'.

Legend:

1. Menu: maneuvering between the GUI main features/tabs.
2. The name of the currently opened feature/tab.
3. Available only after logging in; a drop-down menu, enables to change your password or log out from the program.
4. The area where you can view and/or set the feature parameters.





5.5 Live View Window

The Live View window allows viewing the Sarix TI Camera live video.

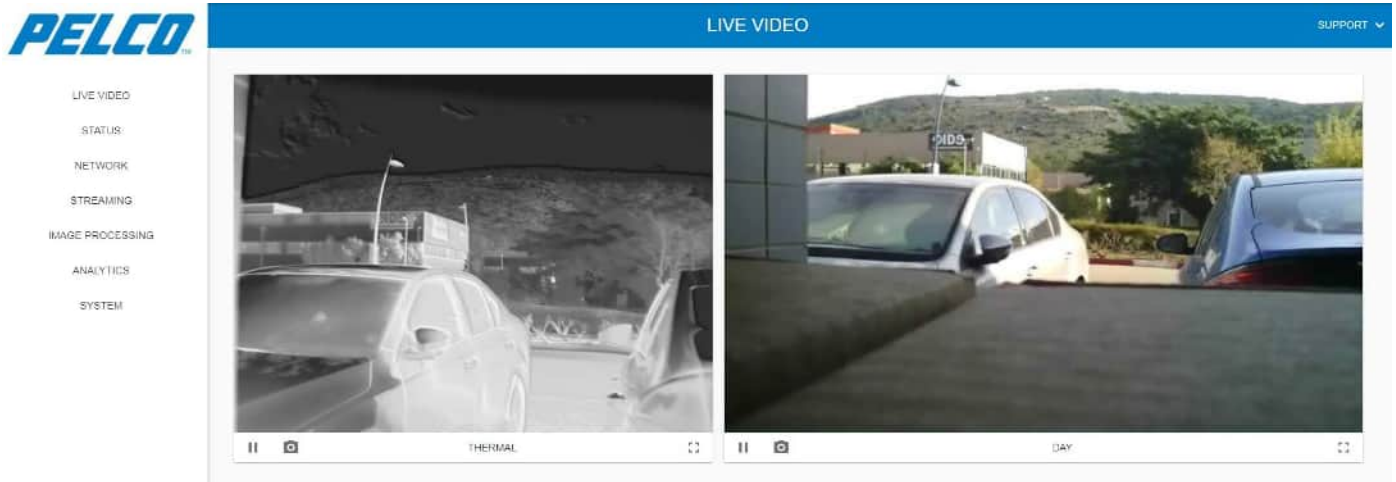
1. Click **Live View**. The Live View window opens, containing a live video display of both thermal and visual cameras (example):

Figure 5-9: Live View Window (example)



2. To freeze the live-view video click . Click  to resume the live-view video.
3. To view the video in full screen click . Click the keyboard **Esc** key to resume.
4. To take a snapshot of the video and save elsewhere:
 - a. Click . A *.jpg file is created and downloaded into your PC. The file is saved in your **Downloads** folder.
 - the file name of the thermal camera snapshot: **proxycam-ir-Snapshot**.
 - the file name of the visual camera snapshot: **proxycam-vis-Snapshot**.
 - b. You can now move the file elsewhere.

5.6 Status Window

The Status window allows viewing some of the Sarix TI Camera parameters and settings.

1. Click **Status**. The Status window opens (all collapsed):

Figure 5-10: Status Window (all collapsed)

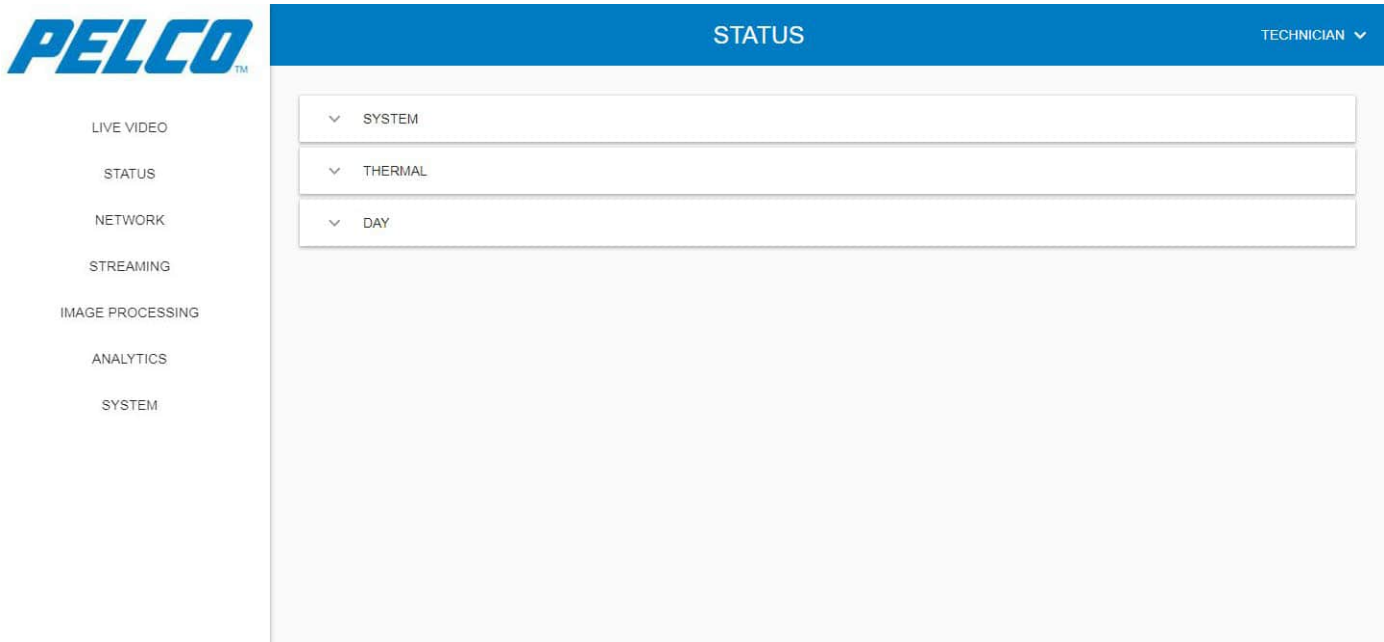

The Status window is comprised of three tabs:

- **System Tab:** allows viewing general parameters related to the camera settings and its software/firmware (see Section 5.6.1).
- **Thermal Tab:** allows viewing parameters related to the thermal camera settings and its software/firmware (see Section 5.6.2).
- **Day Tab:** allows viewing parameters related to the visual camera settings and its software/firmware (see Section 5.6.3).
- **Disabling / Enabling a Camera:** allows disabling the thermal camera and/or the visual camera and enable them (see Section 5.6.4).

5.6.1 System Tab

The System tab allows viewing general parameters related to the camera settings and its software/firmware.

Expand the **System** tab. The following opens:

Figure 5-11: Status Window - System Tab

The screenshot shows the PELCO STATUS interface. On the left is a navigation menu with options: LIVE VIDEO, STATUS, NETWORK, STREAMING, IMAGE PROCESSING, ANALYTICS, and SYSTEM. The main content area is titled 'STATUS' and contains a 'SYSTEM' tab. The SYSTEM tab displays the following parameters:

System temperature 26.00 C.	System up time 5 min	System load Load Average: 1.35, 0.99, 0.43
Onvif service URI http://192.168.0.100:8000/onvif/device_service	IP address 192.168.0.100	Product SB-OP
MAC address 70:b3:d5:2a:d1:c0	Firmware version 1.0.40.3314	Build date Nov 27 2017 12:13:35
Serial number		

Below the SYSTEM tab are two collapsed tabs: THERMAL and DAY. A 'COLLAPSE' button is visible at the bottom of the SYSTEM tab.

The System tab consists of the following parameters:

- **System temperature:** the "System On Chip" temperature.
- **System up time:** the operating time since the last camera startup.
- **System load:** a coded indication on how the system is busy.
- **ONVIF service URI:** the Uniform Resource Indicator (URI), e.g., the ONVIF device web service address.
- **IP address:** the camera IP address.
- **Product:** the camera name.
- **Serial number:** the system Serial Number (S/N).
- **Firmware version:** the version of the installed Firmware (FM).
- **Build date:** the date of the FM creation.
- **MAC address:** the camera unique Media Access Control (MAC) address.

5.6.2 Thermal Tab

The Thermal tab allows viewing parameters related to the thermal camera settings and its software/firmware.

Expand the **Thermal** tab. The following opens:

Figure 5-12: Status Window - Thermal Tab

The screenshot shows the PELCO STATUS interface. On the left is a navigation menu with options: LIVE VIDEO, STATUS, NETWORK, STREAMING, IMAGE PROCESSING, ANALYTICS, and SYSTEM. The main content area is titled 'STATUS' and 'TECHNICIAN'. Under 'ARCHIVE: SYSTEM FILES', the 'THERMAL' tab is expanded. The data is presented in a table-like format with three columns:

Parameter	Value	Parameter	Value	Parameter	Value
Model	PELCO-EYE-QTH	Online/Offline	Yes	Online/Offline	No
Actual FPS	25	Ons	54977	Firmware version	0x4021
Gain	3	Frame rate (Hz)	25	Serial number	230012137
Software version	0x40	TRT	540	Sensor Temp (1)	27.25
Vhrs	1884	Vdts	25489	Vgfr	2126
Vgpr	1043	Vdss	1355	Vtbl	1727

At the bottom of the window, there are buttons for 'COLLAPSE' and 'DISABLE CAMERA'.

The Thermal tab consists of the following parameters:

- **Pipeline ID:** the current name of the pipeline (data processing elements, connected in series, where the output of one element is the input of the next one).
- **Pipeline Running:** is the pipeline running?
- **Pending Updates:** does the pipeline requires initialization?
- **Actual FPS:** the current frame-rate where the pipeline is running.
- **DFPA:** indication from the thermal camera.
- **Firmware version:** indication from the thermal camera.
- **Gain:** indication from the thermal camera.
- **Frame rate [Hz]:** indication from the thermal camera.
- **Serial number:** indication from the thermal camera.
- **Software version:** indication from the thermal camera.
- **TINT:** indication from the thermal camera.
- **Sensor temp [°C]:** indication from the thermal camera.
- **V bus:** indication from the thermal camera.
- **VDDA:** indication from the thermal camera.
- **VGFIID:** indication from the thermal camera.
- **VGSK:** indication from the thermal camera.
- **VT bias:** indication from the thermal camera.
- **VTOFS1:** indication from the thermal camera.
- **VTOFS2:** indication from the thermal camera.

5.6.3 Day Tab

The Day tab allows viewing parameters related to the thermal camera settings and its software/firmware.

Expand the **Day** tab. The following opens:

Figure 5-13: Status Window - Day Tab

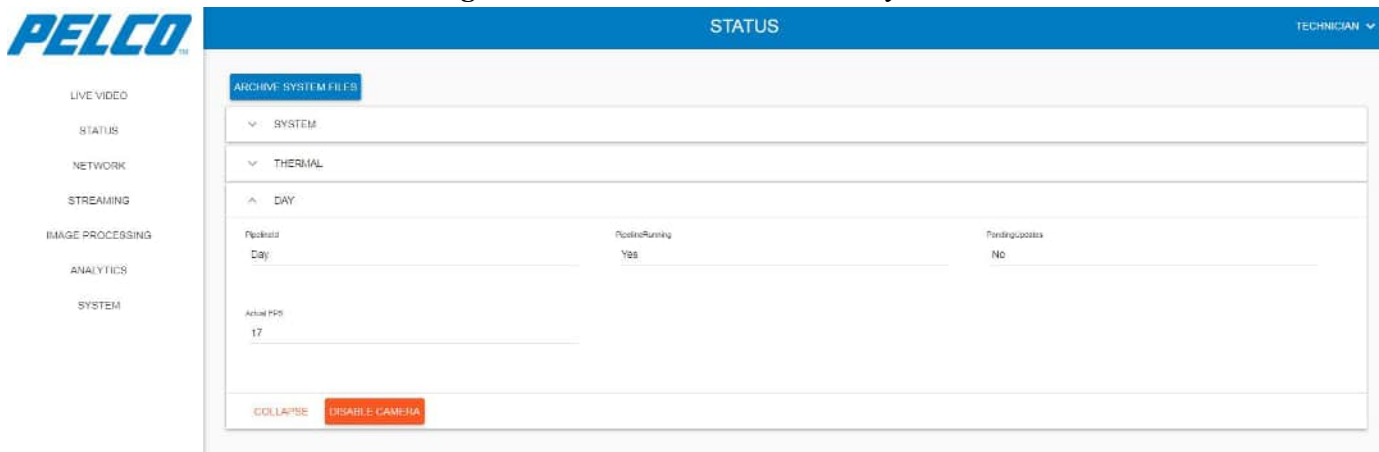

The Day tab consists of the following parameters:

- **Pipeline ID:** the current name of the pipeline.
- **Pipeline Running:** is the pipeline running?
- **Pending Updates:** does the pipeline requires initialization?
- **Actual FPS:** the current frame-rate where the pipeline is running.

5.6.4 Disabling / Enabling a Camera

This option allows to disable the thermal camera and/or the CMOS camera and re-enable them.

5.6.4.1 Disabling the Camera

1. Expand the Thermal / Day tab and click **DISABLE CAMERA**. The following opens:

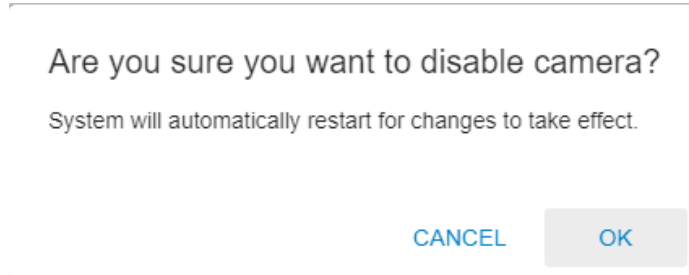

2. Click **OK** to approve. The following opens while the system re-boots:

Figure 5-14: Disabling / Enabling a Camera - System Reboot

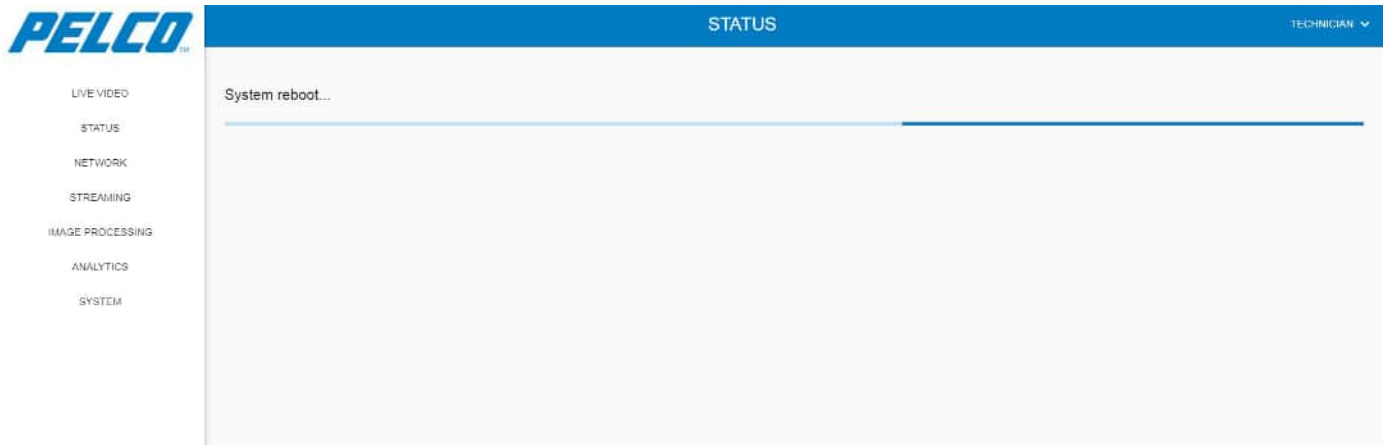

On completion, the following opens stating that the corresponding camera is disabled:

Figure 5-15: Disabling / Enabling a Camera - System Reboot Approval

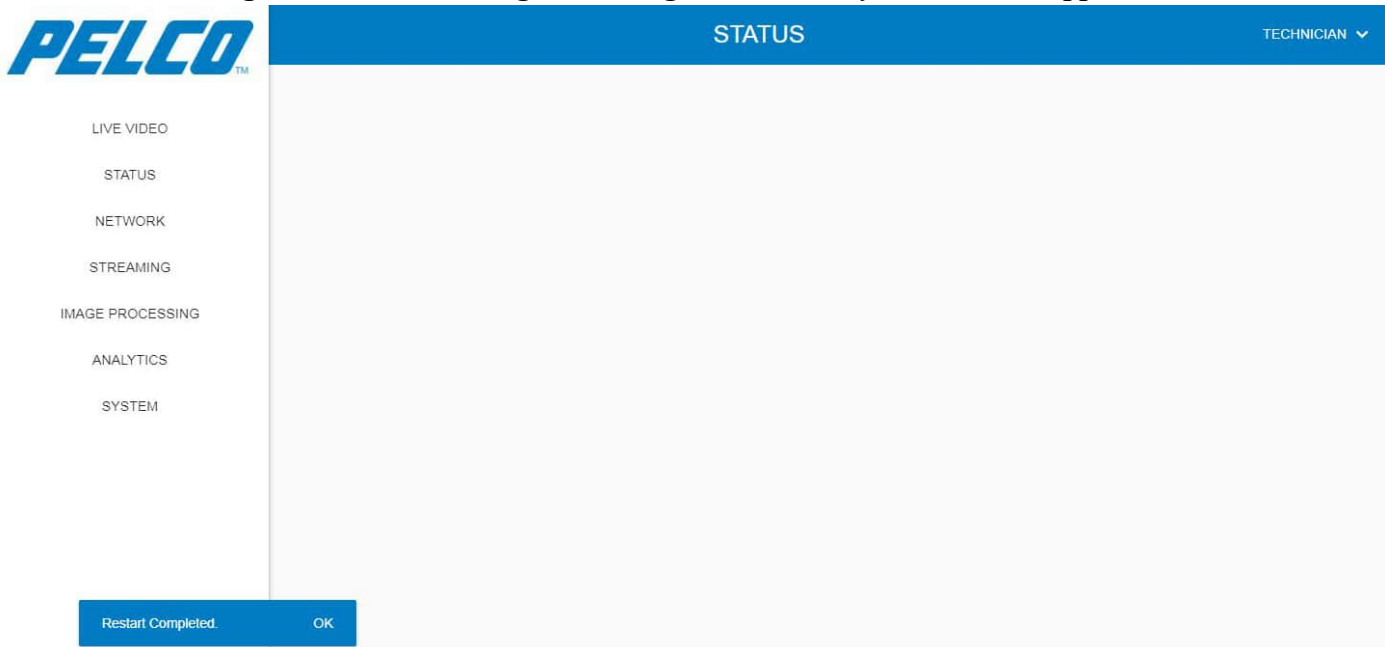

The camera view does not appear anymore on the Live View window.

5.6.4.2 Enabling the Camera

1. Expand the Thermal / Day tab and click **ENABLE CAMERA**. The following opens:

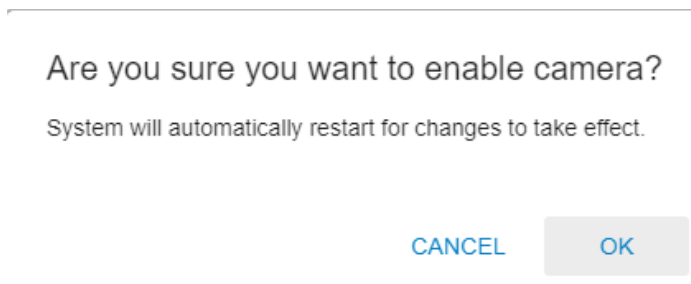

2. Click **OK** to approve. The system re-boots (see [Figure 5-14](#)). On completion, a message is displayed stating that the system has restarted (see [Figure 5-15](#)).

The camera view is now available on the Live View window.

5.7 Network Window

The Network window allows configuring the HOST-to-Camera Ethernet communication method.

1. Click **Network**. The Ethernet window - Basic Settings tab opens:

Figure 5-16: Network Window - Basic Settings Tab

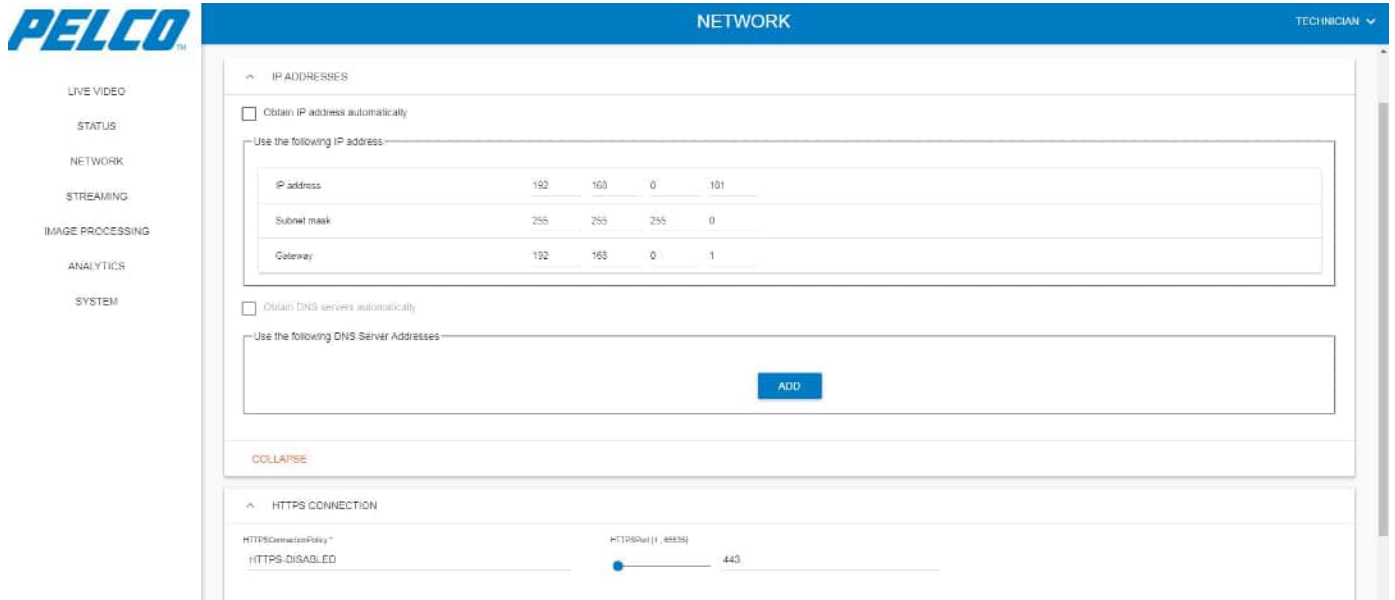

5.7.1 Setting of IP Address

To change the IP address, Subnet mask or Gateway values:

1. Click on the corresponding address and change the value either using the  button or type the IP address using the keyboard. An example is shown in [Figure 5-17](#):

Figure 5-17: Network Window - Changing an Address



The screenshot shows the PELCO NETWORK configuration interface. The left sidebar contains navigation options: LIVE VIDEO, STATUS, NETWORK, STREAMING, IMAGE PROCESSING, ANALYTICS, and SYSTEM. The main content area is titled 'NETWORK' and has a 'TECHNICIAN' dropdown menu. Under 'BASIC SETTINGS', there are two tabs: 'BASIC SETTINGS' (active) and 'CERTIFICATES'. The 'Obtain IP address automatically' checkbox is unchecked. Below it, a section titled 'Use the following IP address' contains a table with the following data:

IP address	10	29	212	246
Subnet mask	255	255	255	0
Gateway	10	29	212	1

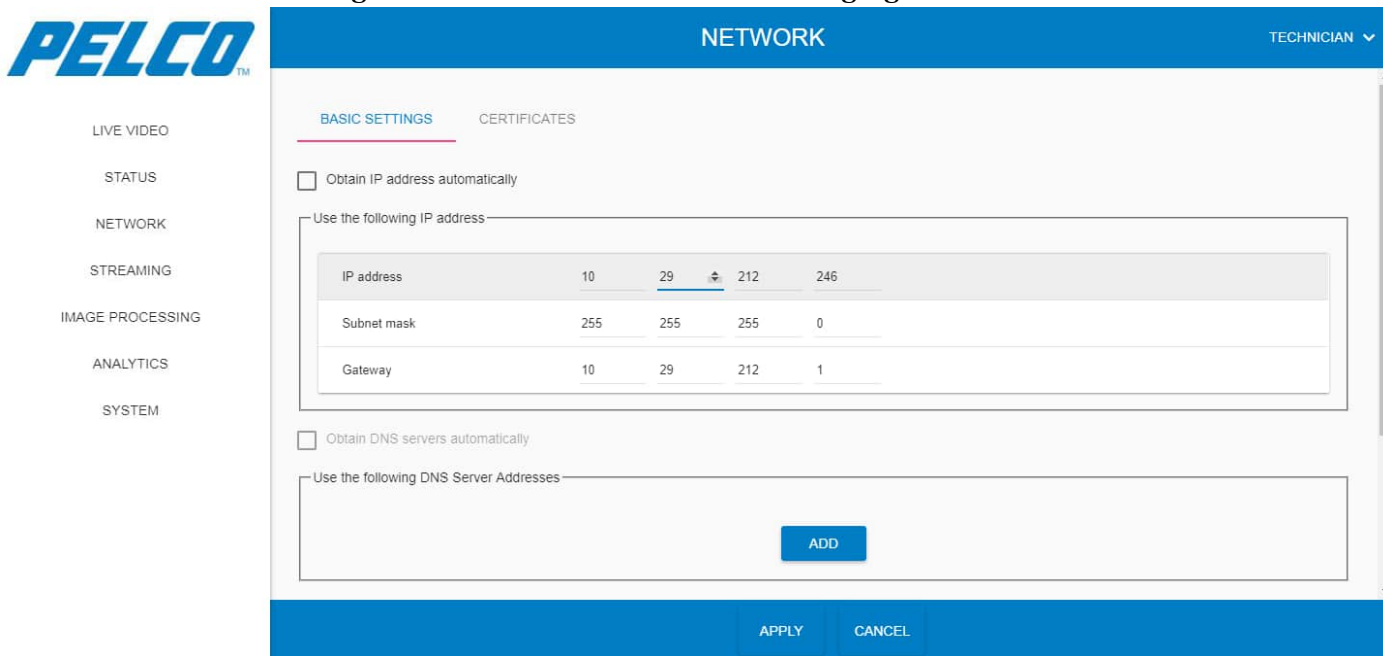
The 'Obtain DNS servers automatically' checkbox is also unchecked. Below it, a section titled 'Use the following DNS Server Addresses' contains an empty text area and an 'ADD' button. At the bottom of the window, there are 'APPLY' and 'CANCEL' buttons.

2. Click **APPLY** for the changes to take effect (click **CANCEL** to revert your changes).

5.7.2 Setting an Auto IP Address (DHCP)

To set a dynamically assigned IP address:

1. Select the **Obtain IP address automatically** checkbox. *Results:*
 - The address area turns invalid.
 - the DNS area become valid.
2. To let the system to select an auto DNS server address: enable the DNS area by selecting the **Obtain IP address automatically** checkbox. The **Obtain DNS servers automatically** checkbox is automatically selected.
3. Click **APPLY** for the changes to take effect (click **CANCEL** to revert your changes).

5.7.3 Setting a Manual DNS Server Address

This option is applicable when you wish to synchronize the time and date with a DNS server (see Section 5.11.3.2).

To manually select a DNS server address:

1. Enable the DNS area by selecting the **Obtain IP address automatically** checkbox. The **Obtain DNS servers automatically** checkbox is automatically selected.
2. Clear the **Obtain DNS servers automatically** checkbox.
3. Click **ADD**. An empty DNS line is added.
4. Determine the address.
5. Click **APPLY** for the changes to take effect (click **CANCEL** to revert your changes).

5.7.4 Settings of HTTPS Connection

This option is applicable when selecting either a self-signed certificate or uploading an existing certificate (see Section 5.7.7).

To set the HTTPS connection:

1. Set the HTTPS Port bar to the required value (1 to 65535).
2. Click **APPLY** for the changes to take effect (click **CANCEL** to revert your changes).

5.7.5 Setting the Network Interface

To have the network interface permanently set to 100 Mbps:

1. Select the **Advanced** tab. The following opens:

Figure 5-18: Network Window - Setting Network Interface

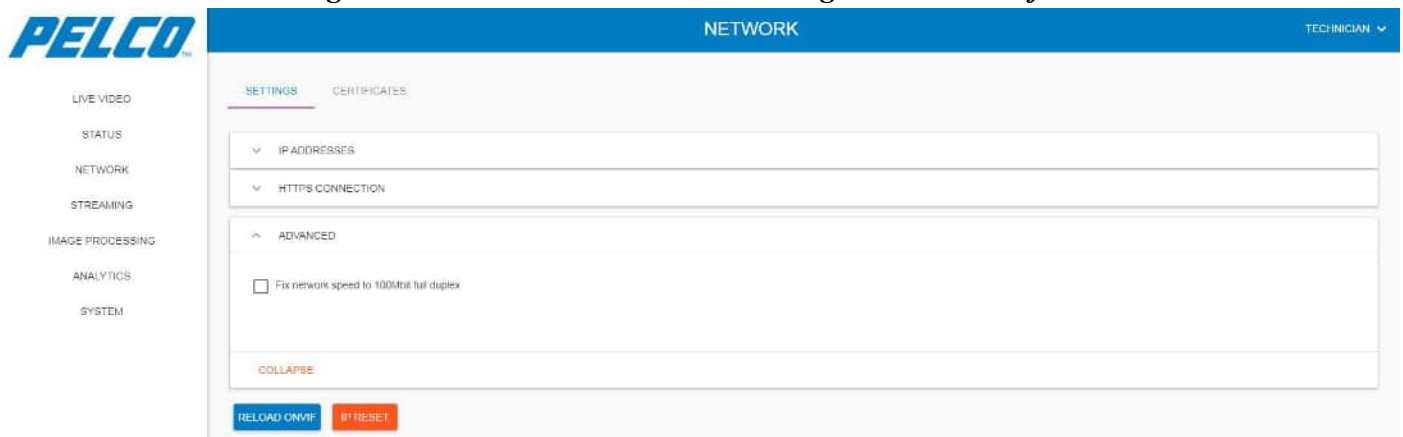

2. Select the **Fix network speed to 100Mbit full duplex** checkbox.

5.7.6 Resetting Network Settings

To revert network settings back to factory defaults:

1. Click **IP RESET**. The following opens:

Figure 5-19: Network Window - Resetting IP Address Approval

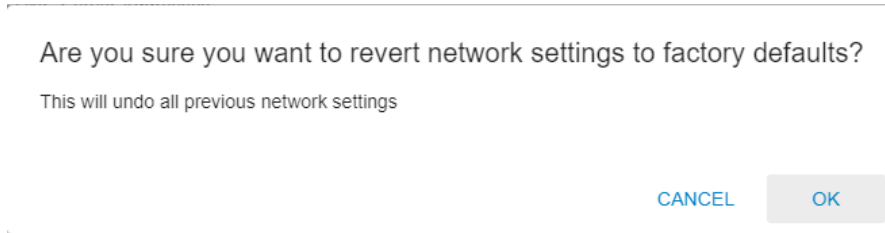

2. Click **OK** to revert network settings back to factory defaults.

5.7.7 Restarting ONVIF Service

To restart the system and reload ONVIF service:

- Click **RELOAD ONVIF**. The following opens while the system re-starts:

Figure 5-20: Network Window - ONVIF Reload

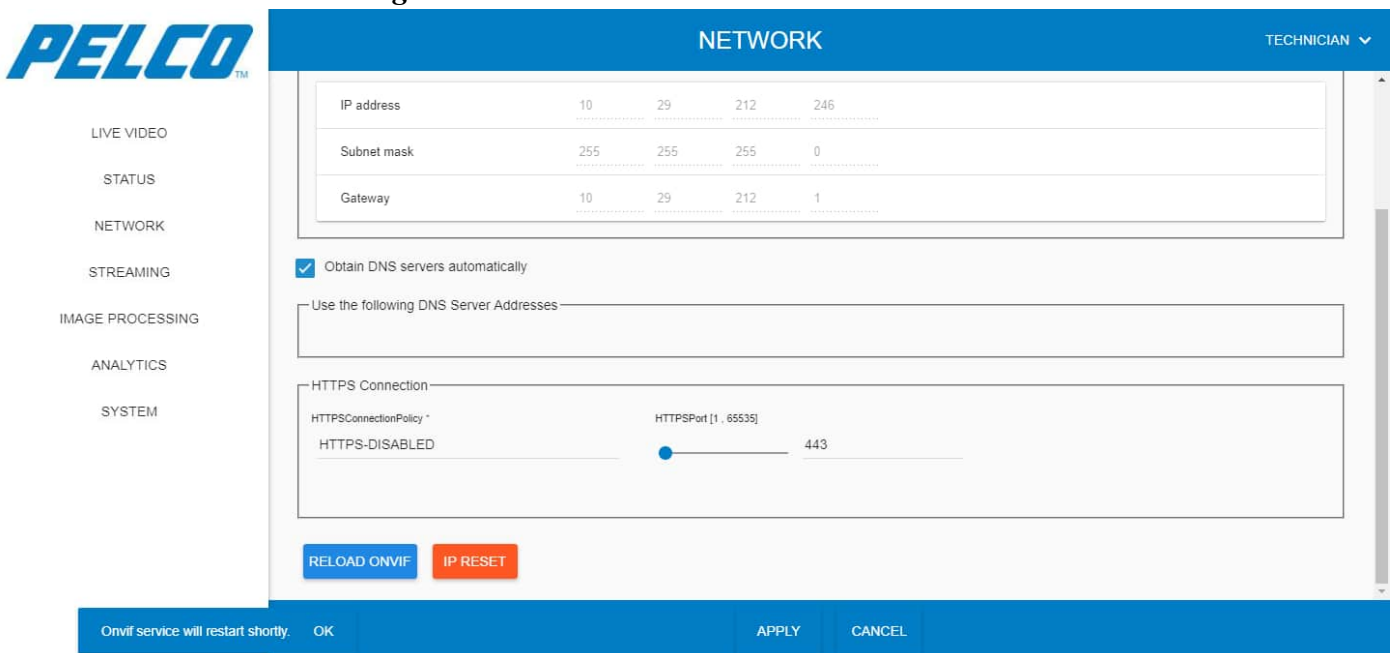

NOTE

The **HTTPS Port** default value is **443**.

5.7.8 Certificates

5.7.8.1 Creating a Certificate Request

This option allows retrieval of a Secure Sockets Layer (SSL) certificate.

1. Select the **Certificates** tab. The following opens:

Figure 5-21: Certificates - Creating a Certificate Request

The screenshot shows the PELCO NETWORK interface. The left sidebar contains navigation options: LIVE VIDEO, STATUS, NETWORK, STREAMING, IMAGE PROCESSING, ANALYTICS, and SYSTEM. The main content area is titled 'NETWORK' and 'TECHNICIAN'. Under 'SETTINGS', the 'CERTIFICATES' tab is selected. Three radio buttons are present: 'Create Certificate Request' (selected), 'Generate Self Signed Certificate', and 'Upload Certificate'. Below, the 'Create Certificate Request' form includes fields for 'Common Name', 'State Or Province', 'Country' (a dropdown menu), 'City', 'Organization', and 'Department'. A blue 'SUBMIT' button is located at the bottom right of the form.

2. Enter/select the following details:
 - Common Name (compulsory; an IP address or system Host name).
 - State or Province
 - Country (select from the drop-down list)
 - City
 - Organization
 - Department
3. Click **SUBMIT**. Your request is submitted for approvals.

5.7.8.2 Generating a Self-Signed Certificate

This option allows producing a self-made certificate.

1. Select the **Generate Self-Signed Certificate** option. The following opens:

Figure 5-22: Certificates - Generating a Self-Signed Certificate

The screenshot shows the PELCO NETWORK interface. The left sidebar contains navigation options: LIVE VIDEO, STATUS, NETWORK, STREAMING, IMAGE PROCESSING, ANALYTICS, and SYSTEM. The main content area is titled 'NETWORK' and 'TECHNICIAN'. Under 'SETTINGS', the 'CERTIFICATES' tab is selected. Three radio buttons are present: 'Create Certificate Request', 'Generate Self Signed Certificate' (selected), and 'Upload Certificate'. Below, the 'Generate Self-Signed Certificate' form includes fields for 'Common Name', 'State Or Province', 'Country' (a dropdown menu), 'City', 'Organization', and 'Department'. A 'Validity (1 - 122)' slider is visible, with a value of 365. A blue 'SUBMIT' button is located at the bottom right of the form.

2. Enter/select the following details:
 - Common Name (compulsory; an IP address or system Host name).
 - State or Province
 - Country (select from the drop-down list)
 - City
 - Organization
 - Department
 - Validity (in days)
3. Click **SUBMIT**. Your self-signed certificate is submitted for approvals.

5.7.8.3 Uploading a Certificate

This option allows loading an existing certificate, originated by another source.

1. Select the **Upload Certificate** option. The following opens:

Figure 5-23: Certificates - Uploading a Certificate

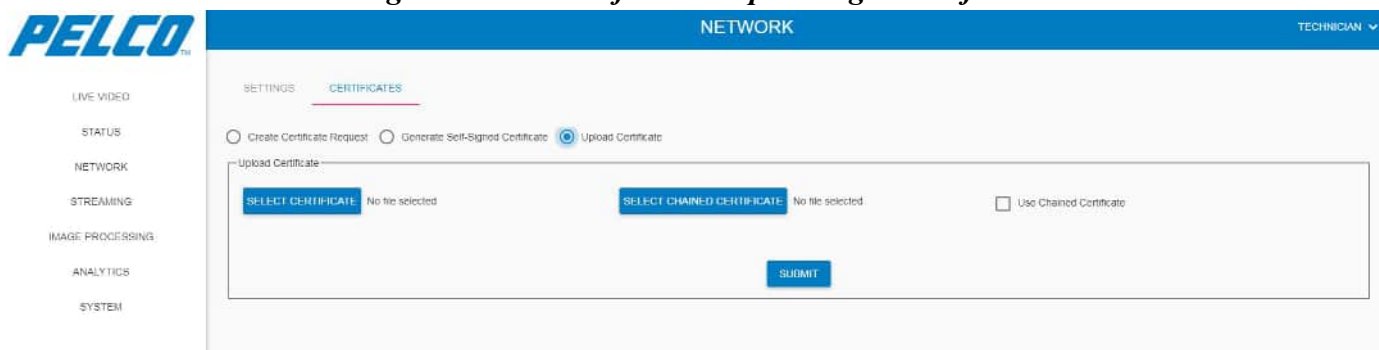

The screenshot shows the PELCO NETWORK interface. On the left is a navigation menu with options: LIVE VIDEO, STATUS, NETWORK, STREAMING, IMAGE PROCESSING, ANALYTICS, and SYSTEM. The main content area is titled 'NETWORK' and 'TECHNICIAN'. Under 'CERTIFICATES', there are three radio buttons: 'Create Certificate Request', 'Generate Self-Signed Certificate', and 'Upload Certificate' (which is selected). Below this, there is a section for 'Upload Certificate' containing two file selection buttons: 'SELECT CERTIFICATE' (with 'No file selected' text) and 'SELECT CHAINED CERTIFICATE' (with 'No file selected' text). To the right of these buttons is a checkbox labeled 'Use Chained Certificate'. A 'SUBMIT' button is located at the bottom right of the form area.

2. Click **SELECT FILE** and browse to select the certificate file (*.pem format).
3. Click **SUBMIT**. Your uploaded certificate is submitted.

5.8 Streaming Window



The Streaming window allows configuring the video flow-rate and the video encoding method.

5.8.1 Thermal Tab

1. Click **Streaming**. The Streaming - Thermal Tab opens:

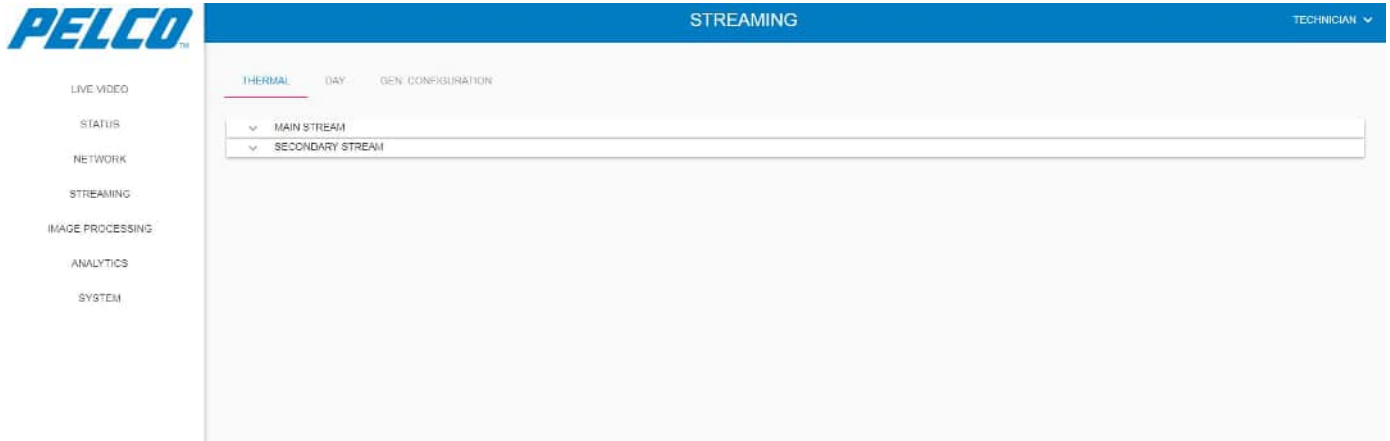
Figure 5-24: Streaming Window - Thermal Tab



2. Under each option in the Thermal Tab you can:
 - Click  to restart the video streaming.
 - Click  to stop the video streaming.
 - Click  to re-start the video streaming.

5.8.1.1 Main Stream

Expand the **Main Stream** option. The following opens (click **APPLY** for the changes to take effect; click **CANCEL** to revert your changes):

Figure 5-25: Streaming Window - Thermal Tab - Main Stream

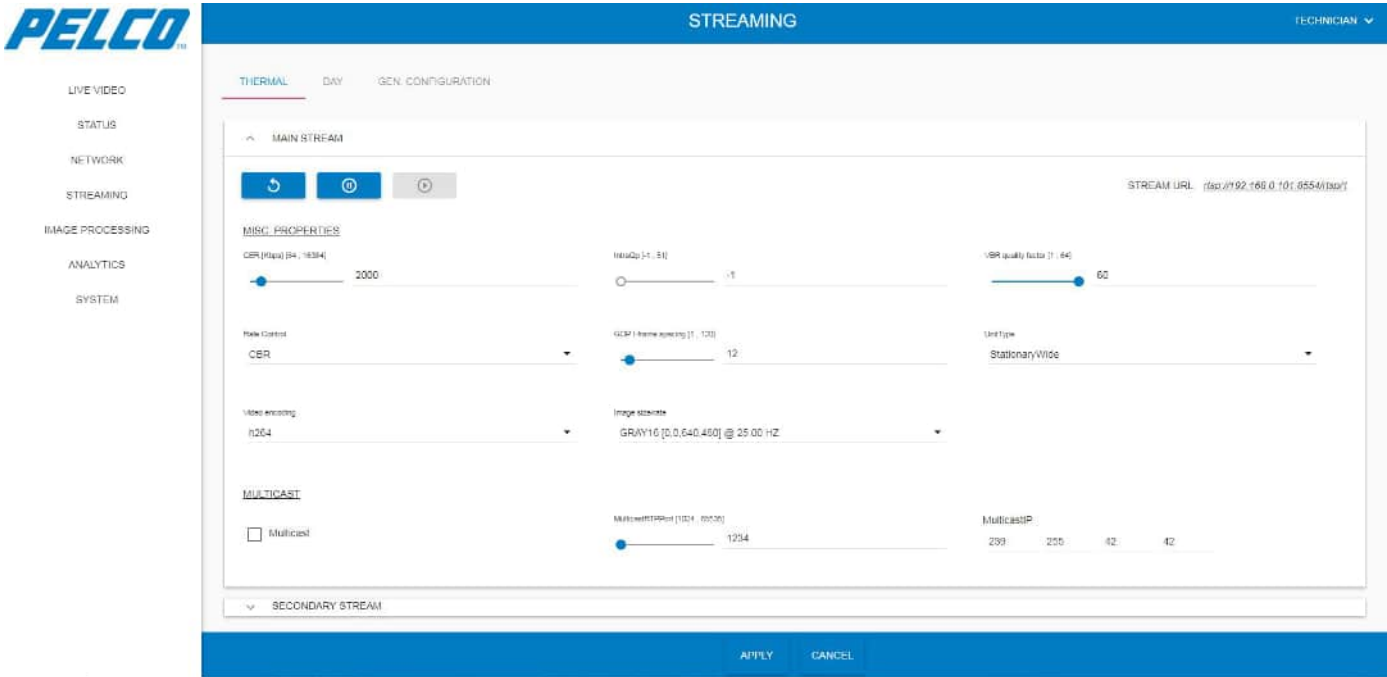

The main stream option consists of the following parameters:

➤ **Misc Properties** parameters:

- **CBR:** the video flow-rate (Kb/Sec).
- **IntraQp:** an auto calculation of the I-level quality-level (default: -1).
- **VBR quality factor:** 1 is the lowest level (applies only for VBR).
- **Rate Control:** Constant Bit Rate (CBR) or Variable Bit Rate (VBR).

CBR
VBR

- **GOP:** Group Of Pictures; how many frames will include an Intra-Frame.

- **Unit Type:** selection of the installed camera/lens type and the installation method.

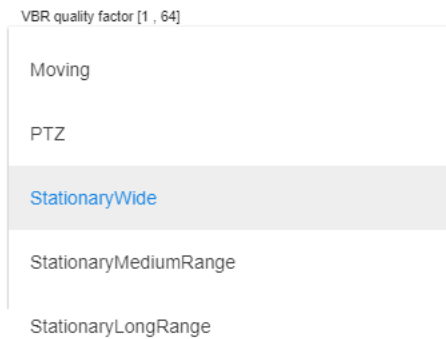

- **Video Encoding:** selection of the video coding (mjpeg requires a system restart).

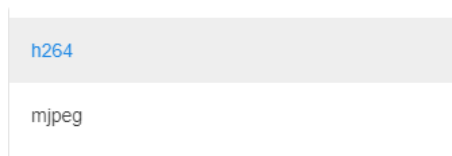

- **Image Size/Rate:** selection of the video that will be taken from the camera.



5.8.1.2 Secondary Stream

Expand the **Secondary Stream** option. The following opens (click **APPLY** for the changes to take effect; click **CANCEL** to revert your changes):

Figure 5-26: Streaming Window - Thermal Tab - Secondary Stream

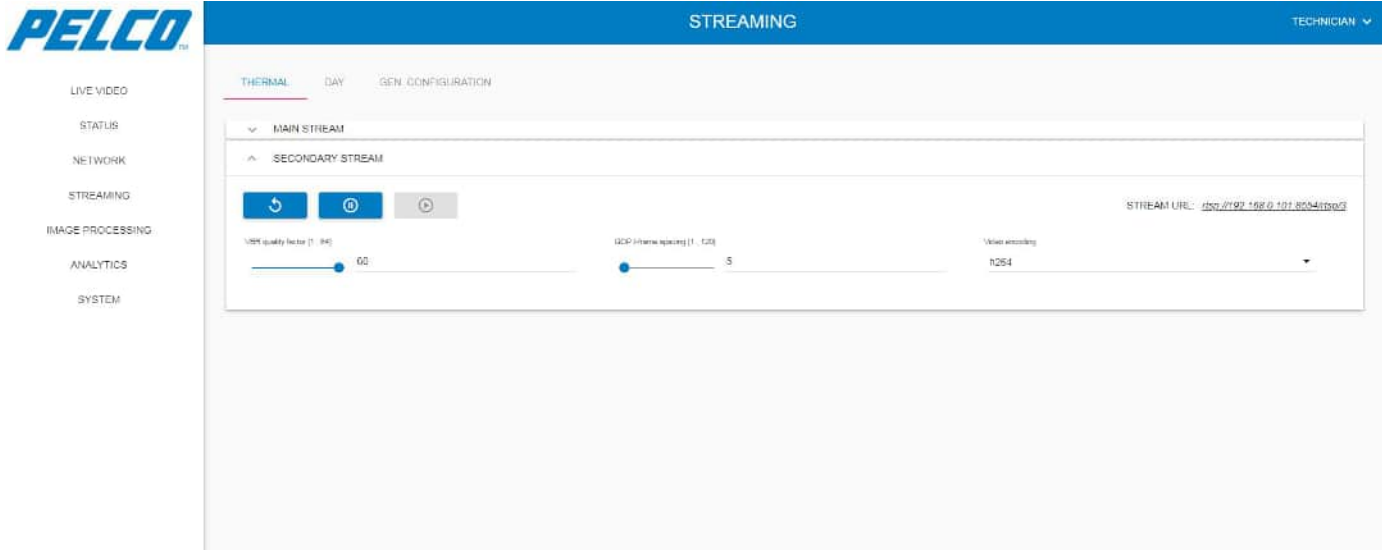



The secondary stream option consists of the following parameters:

- **VBR quality factor:** 1 is the lowest level.
- **GOP I-frame spacing:** Group Of Pictures; how many frames will include an Intra-Frame.
- **Video encoding:** selection of the video coding (mjpeg requires a system restart).



5.8.2 Day Tab

Under each option in the Day Tab you can:

- Click  to restart the video streaming.
- Click  to stop the video streaming.
- Click  to re-start the video streaming.

5.8.2.1 Main Stream



Expand the **Main Stream** option. The following opens (click  for the changes to take effect; click  to revert your changes):

Figure 5-27: Streaming Window - Day Tab - Main Stream



The main stream option consists of the following parameters:

- **CBR:** the video flow-rate (Kb/Sec).
- **IntraQp:** an auto calculation of the I-level quality-level (default: -1).
- **VBR quality factor:** 1 is the lowest level (applies only for VBR).
- **Rate Control:** CBR or VBR.

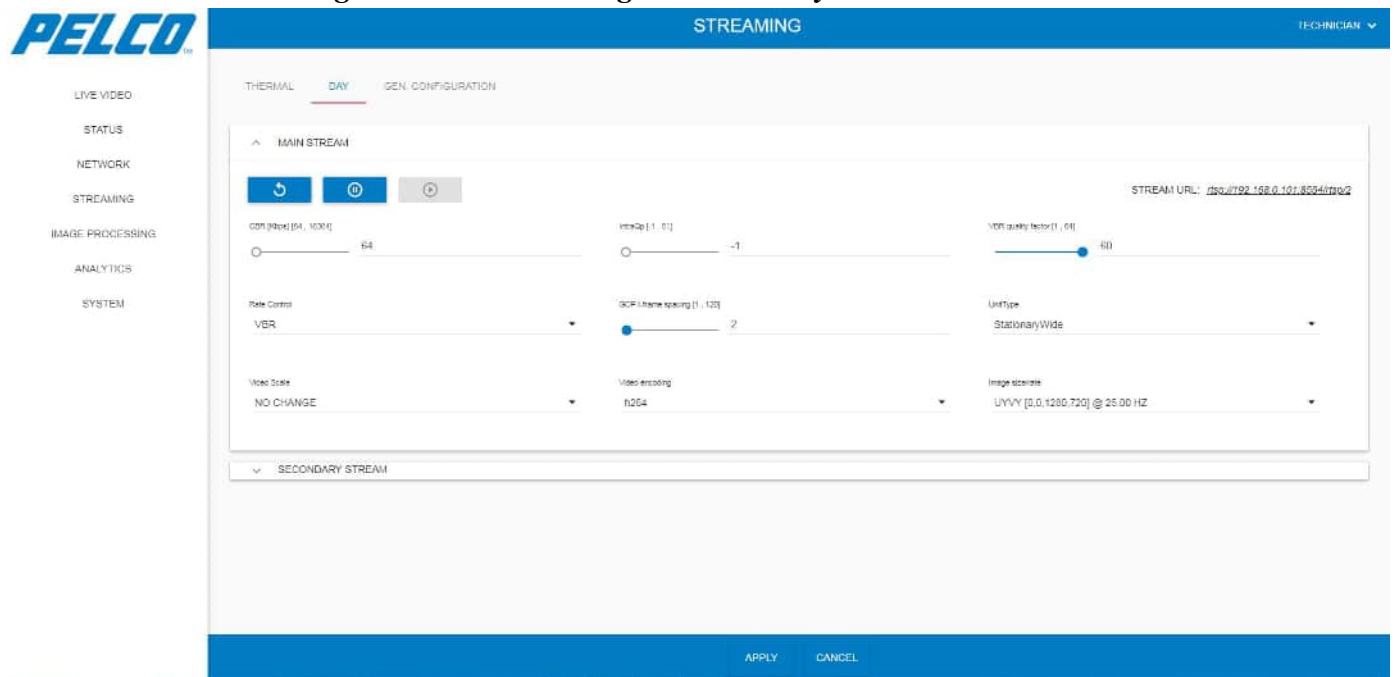

- **GOP:** Group Of Pictures; how many frames will include an Intra-Frame.

- **Unit Type:** selection of the installed camera/lens type and the installation method.

VBR quality factor [1 , 64]

Moving

PTZ

StationaryWide

StationaryMediumRange

StationaryLongRange

- **Video Scale:** the video resolution; "NO CHANGE": 1280 x 720 (HD).

NO CHANGE

320x180

640x360

- **Video Encoding:** selection of the video coding (mjpeg requires a system restart).

h264

mjpeg

- **Image Size/Rate:** selection of the video that will be taken from the camera.

GRAY16 [0,0,640,480] @ 25.00 HZ

GRAY16 [128,96,384,288] @ 25.00 HZ

GRAY16 [160,120,320,240] @ 25.00 HZ

GRAY16 [224,168,192,144] @ 25.00 HZ

5.8.2.2 Secondary Stream

Expand the **Secondary Stream** option. The following opens (click **APPLY** for the changes to take effect; click **CANCEL** to revert your changes):

Figure 5-28: Streaming Window - Day Tab - Secondary Stream

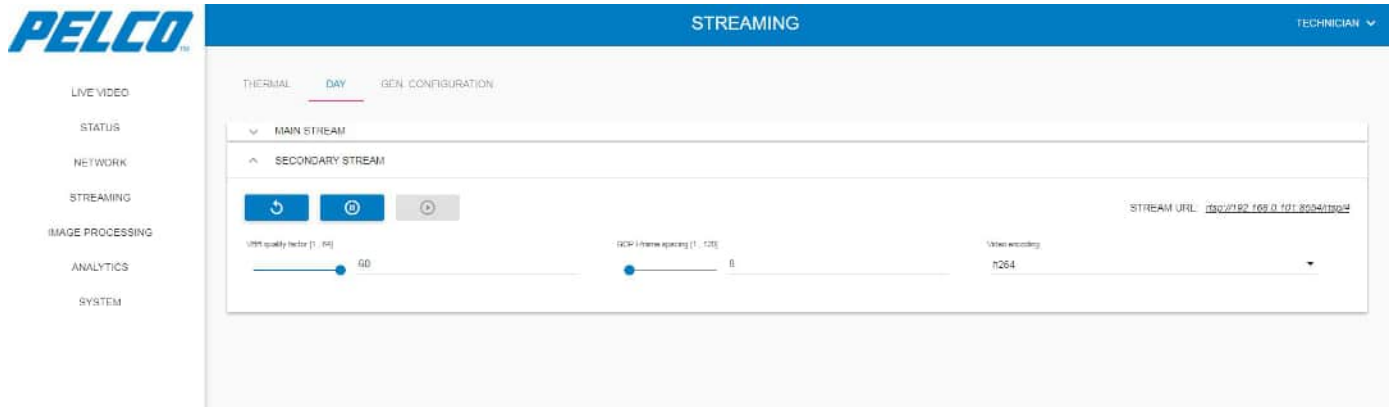

The secondary stream option consists of the following parameters:

- **VBR quality factor:** 1 is the lowest level.
- **GOP I-frame spacing:** Group Of Pictures; how many frames will include an Intra-Frame.
- **Video encoding:** selection of the video coding (mjpeg requires a system restart).

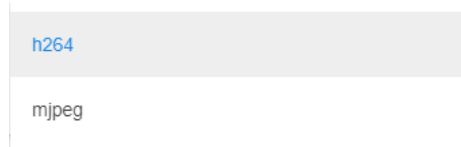

5.8.3 General Configuration Tab

Select the **General Configuration** tab. The following opens (click **APPLY** for the changes to take effect; click **CANCEL** to revert your changes):

Figure 5-29: Streaming Window - General Configuration Tab

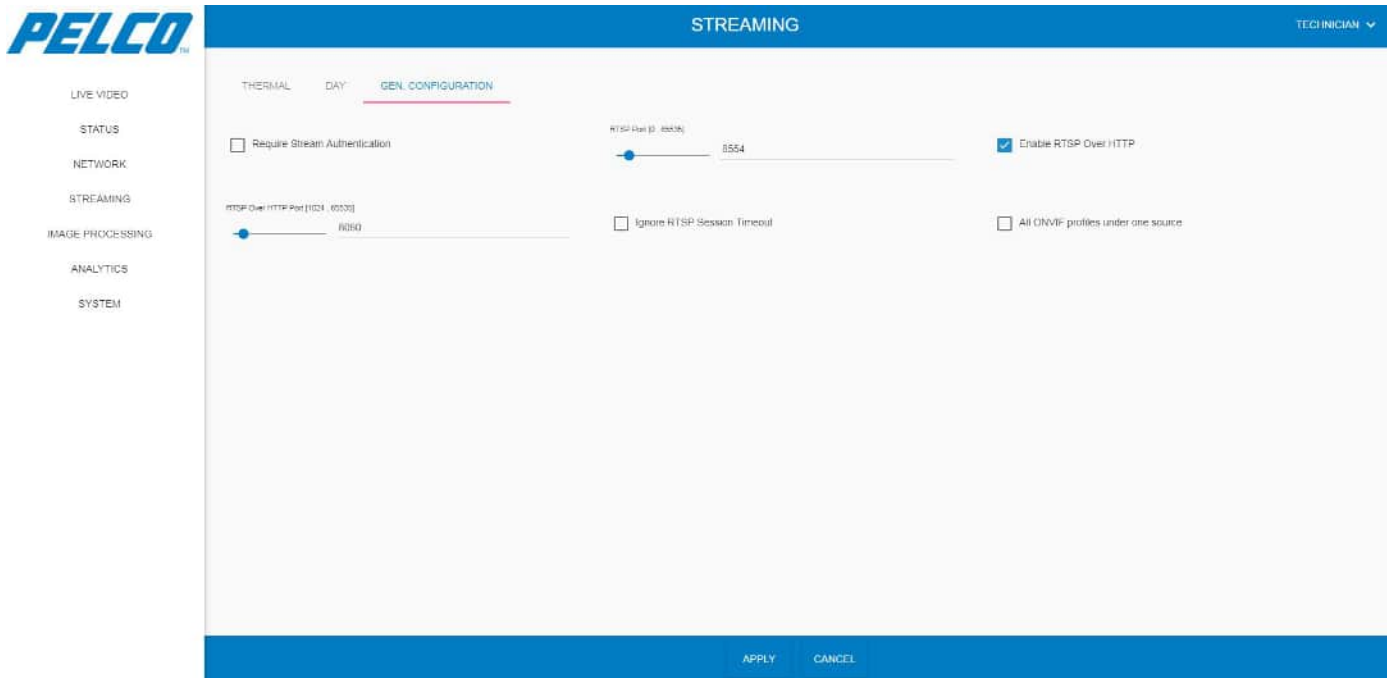

The General Configuration tab consists of the following parameters:

- **Enable Authentication:** user/password enabled.
- **RTSP Port:** the RTSP port.
- RTSP Over HTTP Enabled
- RTSP Over HTTP Port

5.9 Image Processing Window

The Image Processing window allows changing the video display method, orientation and quality.

Click **Image Processing**. The Image Processing - Thermal tab opens.

5.9.1 Thermal Tab

1. You can:

- From the **Active Pipeline** drop-down list select the pipeline name that is currently active (either Night Vision - NV or EyeQ):





- Click  to restart the video streaming.
- Click  to stop the video streaming.
- Click  to re-start the video streaming.

Figure 5-30: Image Processing Window - Thermal Tab



- Applicable for video processing only: click **SITE DEFAULTS** to revert the entire settings to your local site settings. The following opens:

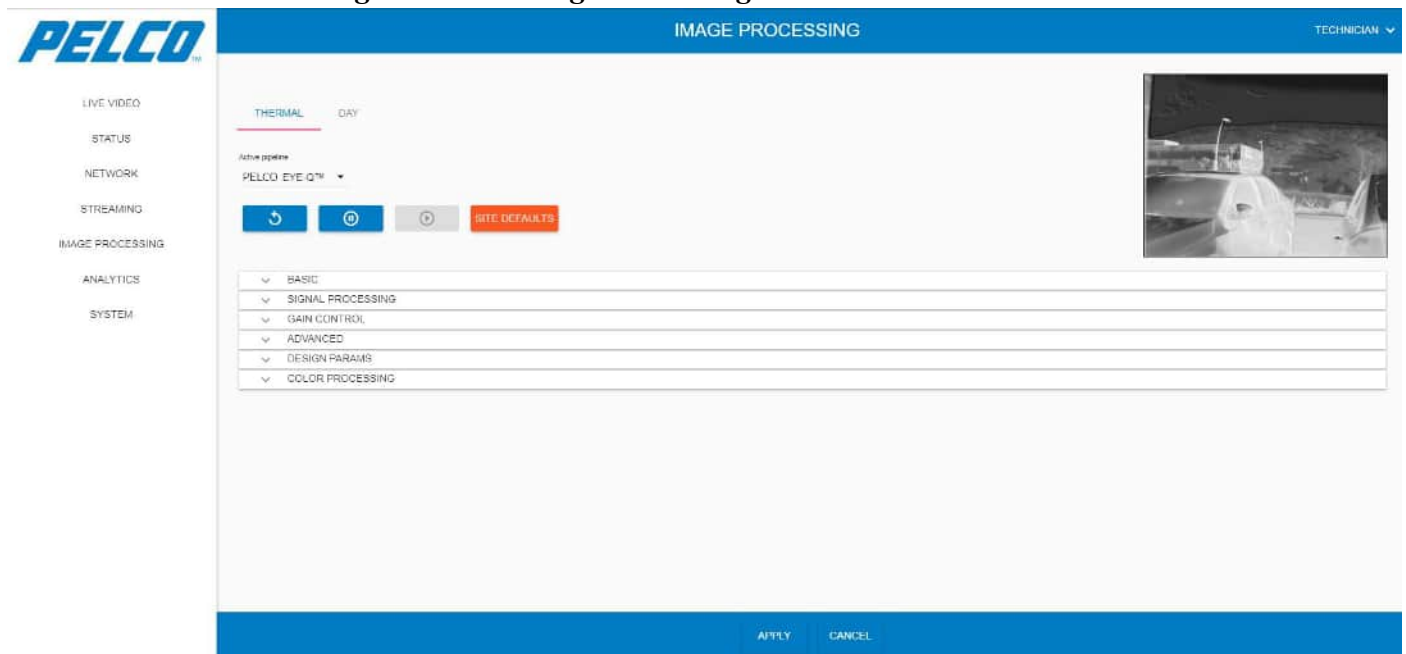
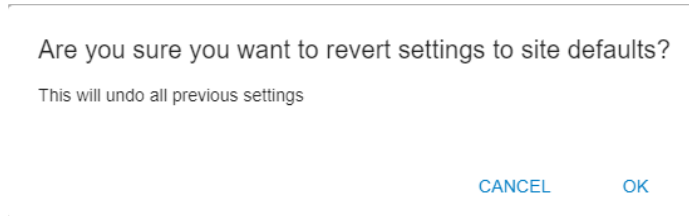

- Click **OK** to approve.
- Click **APPLY** for the changes to take effect (click **CANCEL** to revert your changes).

5.9.1.1 Basic Settings

Expand the **Basic Settings** option. The following opens (click **APPLY** for the changes to take effect; click **CANCEL** to revert your changes):

Figure 5-31: Image Processing Window - Thermal Tab - Basic Settings

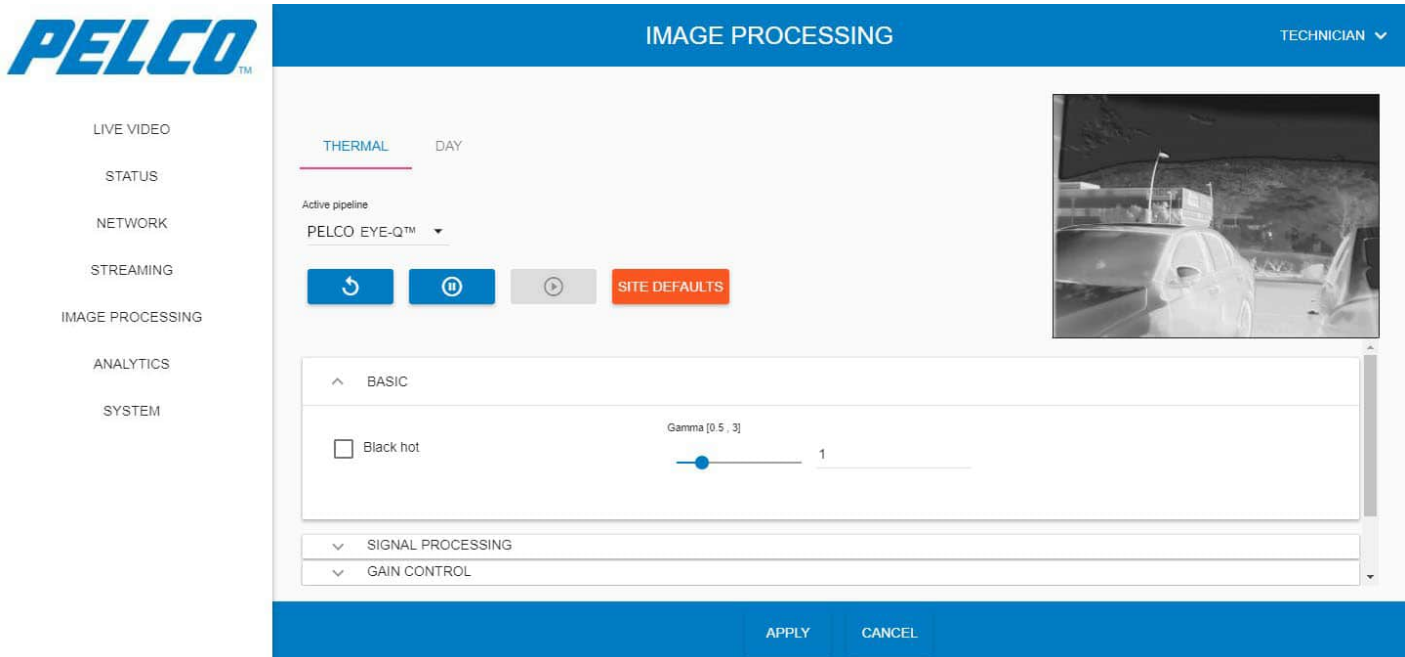

The Basic Settings option consists of the following parameters:

- Black hot: select ("Black Hot") or Clear ("White Hot") the **Black Hot** checkbox. After clicking **APPLY**, the video image display is changing accordantly (example):

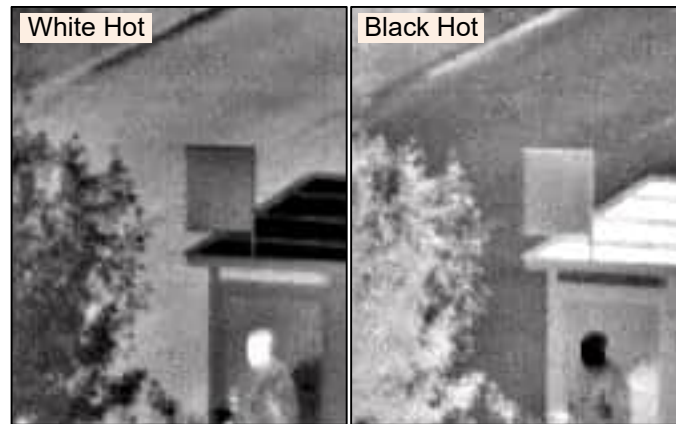

- Gamma: Gamma level corrections.

5.9.1.2 Signal Processing Settings

1. Expand the **Basic Settings** option. The following opens (click **APPLY** for the changes to take effect; click **CANCEL** to revert your changes):

Figure 5-32: Image Processing Window - Thermal Tab - Signal Processing Settings

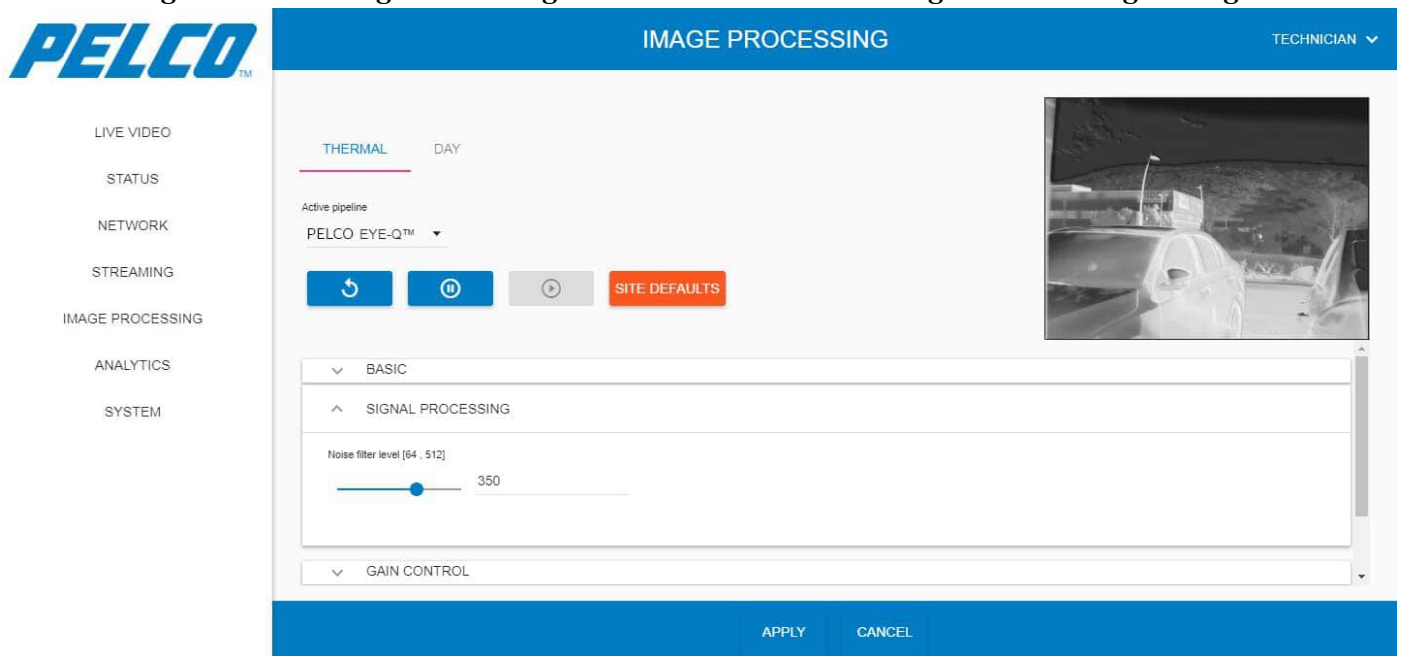

2. Set the **Noise filter level**: filtering noises. It is recommended to remain with the default value (high-value filtering will result in movement smudge).

5.9.1.3 Gain Control Settings

Expand the **Gain Control** option. The following opens (click **APPLY** for the changes to take effect; click **CANCEL** to revert your changes):

Figure 5-33: Image Processing Window - Thermal Tab - Gain Control Settings

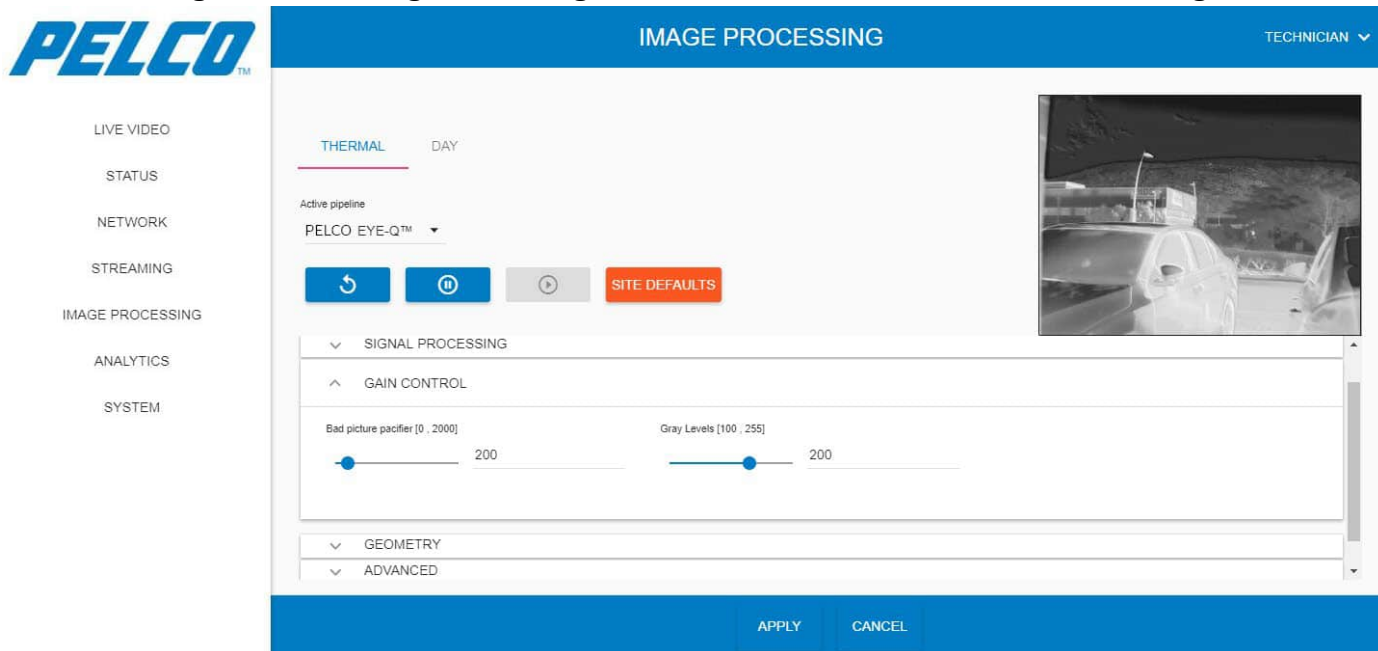

The Gain Control option consists of the following parameters:

- **Bad picture pacifier:** noise-level deductions. It is recommended to remain with the default value.
- **Gray Levels:** the quantity of the gray-levels (up to 200).

5.9.1.4 Advanced Settings

Expand the **Advanced Settings** option. The following opens (click **APPLY** for the changes to take effect; click **CANCEL** to revert your changes):

Figure 5-34: Image Processing Window - Thermal Tab - Advanced Settings

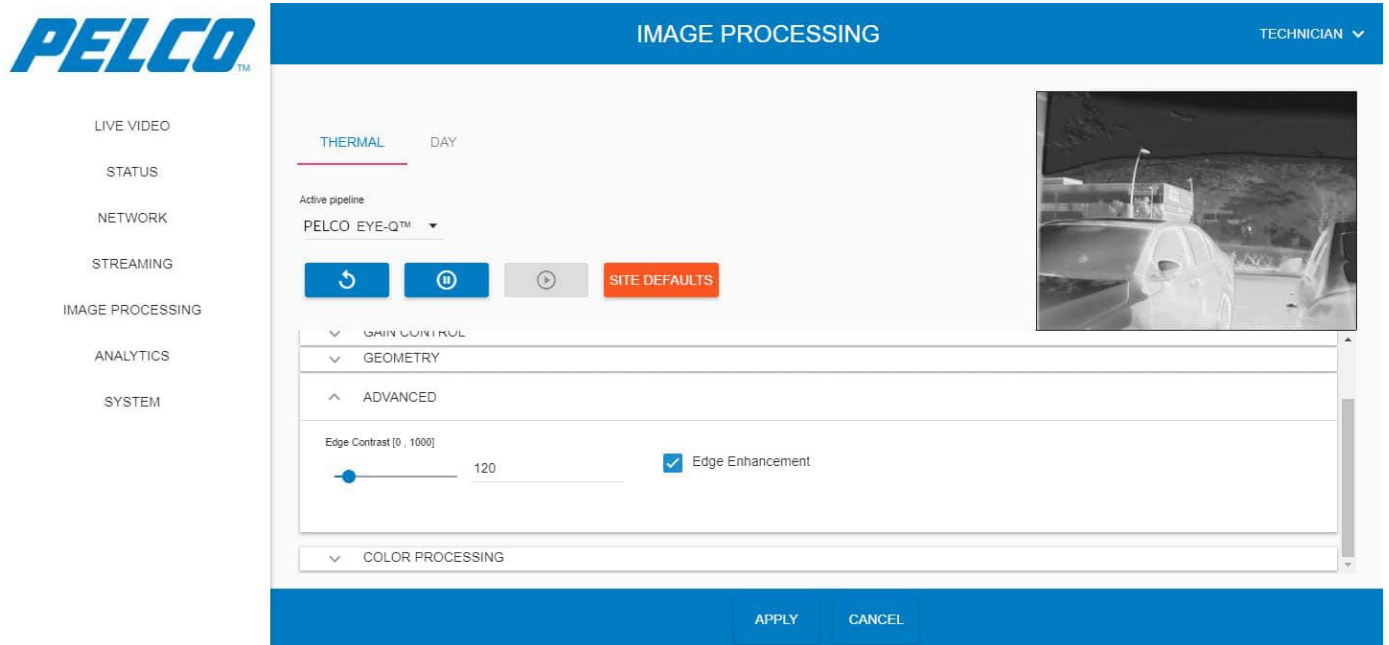

The Advanced Settings option consists of the following parameters:

- **Edge Contrast:** enhancement of the image contrast.
- **Edge Enhancement:** enhancement of the image edges.

5.9.1.5 Color Processing Settings

1. Expand the **Color Processing** option. The following opens (click **APPLY** for the changes to take effect; click **CANCEL** to revert your changes):

Figure 5-35: Image Processing Window - Thermal Tab - Color Processing Settings

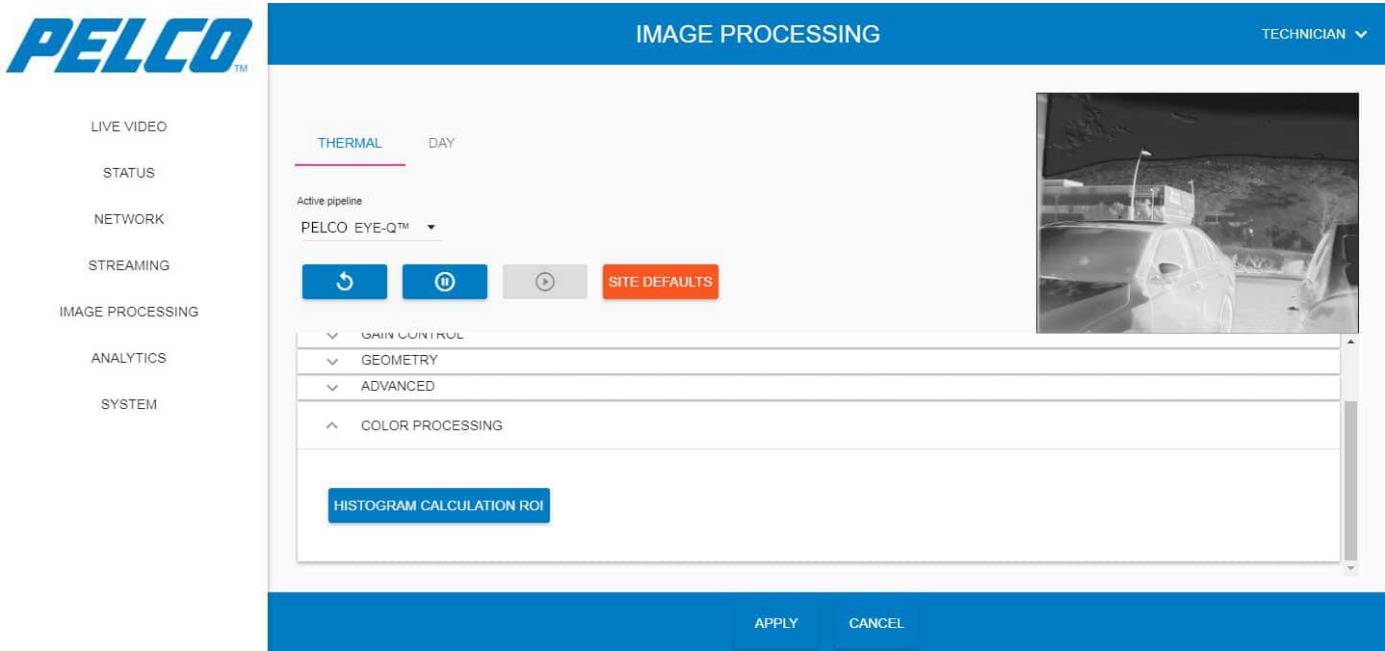

2. Click **HISTOGRAM CALCULATION ROI**. The following opens (example):

Figure 5-36: Image Processing Window - Histogram Calculation ROI (1 of 3)



3. Select the **Allow Region Editing** checkbox allowing to define an ROI on the image. The Regions and Sub-Regions areas are enabled.
4. Click the + sign to enable more than one sub-region.
5. Select **SubRegion-1** and mark an ROI on the image using the mouse (example):

Figure 5-37: Image Processing Window - Histogram Calculation ROI (2 of 3)



6. Click **APPLY**. The Sub Region area is highlighted on the image and the histogram is automatically calculated and saved (the image processing only focuses on the pixels on the pixels within the ROI).

- If more than one SubRegion is defined: select **SubRegion-2** and mark an ROI on the image using the mouse (example):

Figure 5-38: Image Processing Window - Histogram Calculation ROI (3 of 3)

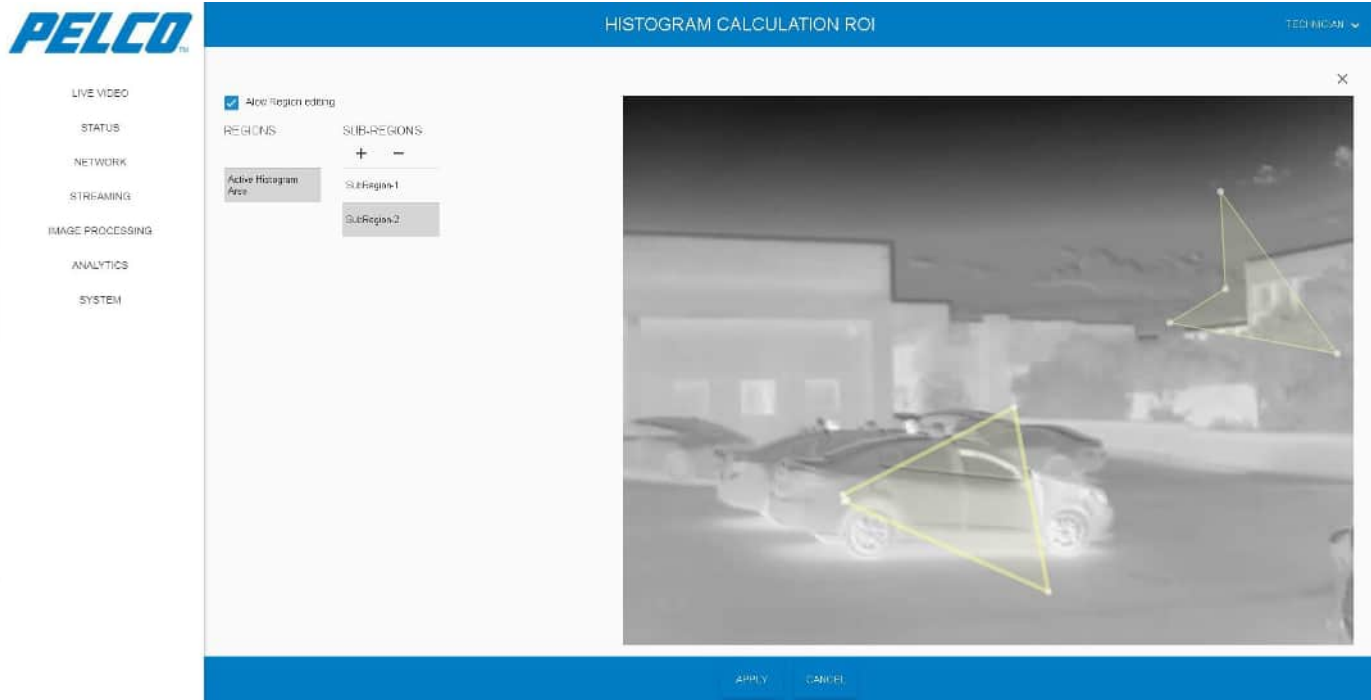

- Click **Active Histogram Area** to define the selected area as the reference for the calculation.
- Click **APPLY**. The Sub Region area is highlighted on the image and the histogram is automatically calculated and saved.
- To delete a Sub Region definitions: select the Sub Region (SubRegion-1 or SubRegion-2 in the example) and click the - sign.
- Clear the **Allow Region Editing** checkbox. The image is cleared from the ROI markings and the buttons are disabled.

5.9.2 Day Tab

1. You can:

- From the **Active Pipeline** drop-down list select the pipeline name that is currently active (Night Vision - NV, or EyeQ):

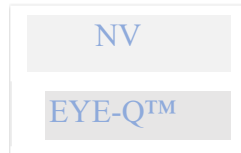



- Click  to restart the video streaming.
- Click  to stop the video streaming.
- Click  to re-start the video streaming.

Figure 5-39: Image Processing Window - Day Tab



- Applicable for video processing only: click **SITE DEFAULTS** to revert the entire settings to your local site settings (saved during Section 5.11.1.4: [Save As Site](#)). The following opens:

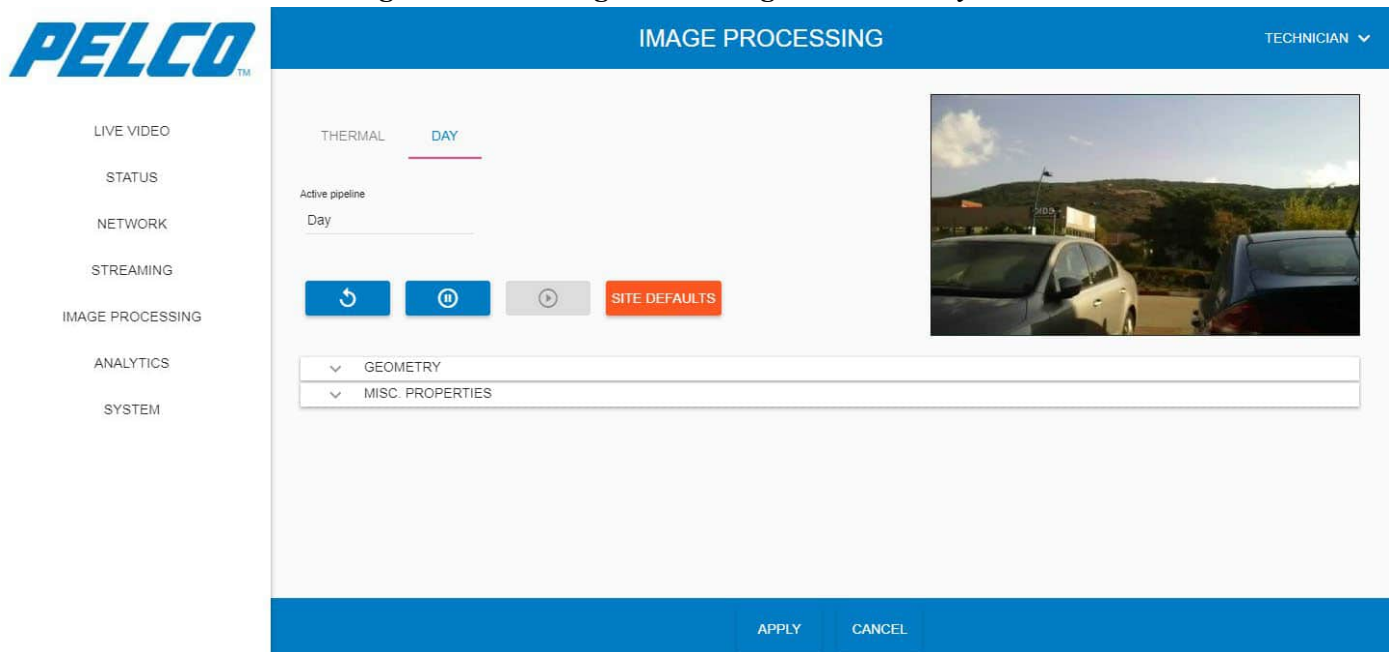
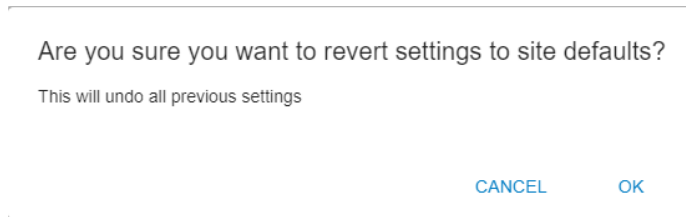

- Click **OK** to approve.
- Click **APPLY** for the changes to take effect (click **CANCEL** to revert your changes).

5.9.2.1 Geometry Settings

Expand the **Geometry Settings** option. The following opens (click **APPLY** for the changes to take effect, click **CANCEL** to revert your changes):

Figure 5-40: Image Processing Window - Day Tab - Geometry Settings

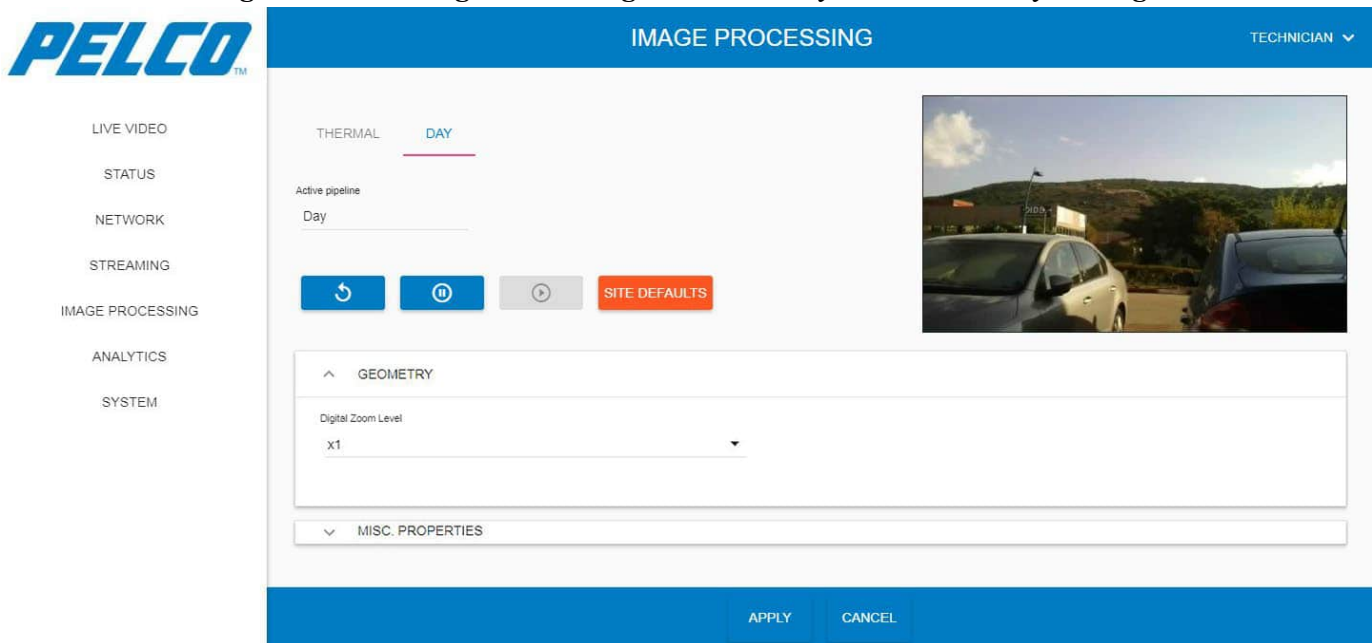

The Geometry Settings option consists of the following parameter:

➤ **Digital Zoom Level:**

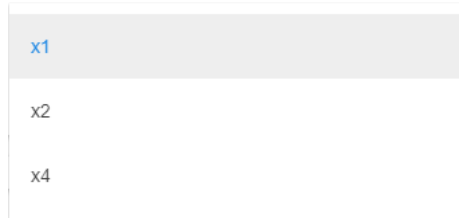

5.9.2.2 Misc. Properties Settings

Expand the **Misc Properties Settings** option. The following opens (click **APPLY** for the changes to take effect, click **CANCEL** to revert your changes):

Figure 5-41: Image Processing Window - Day Tab - Misc Properties Settings

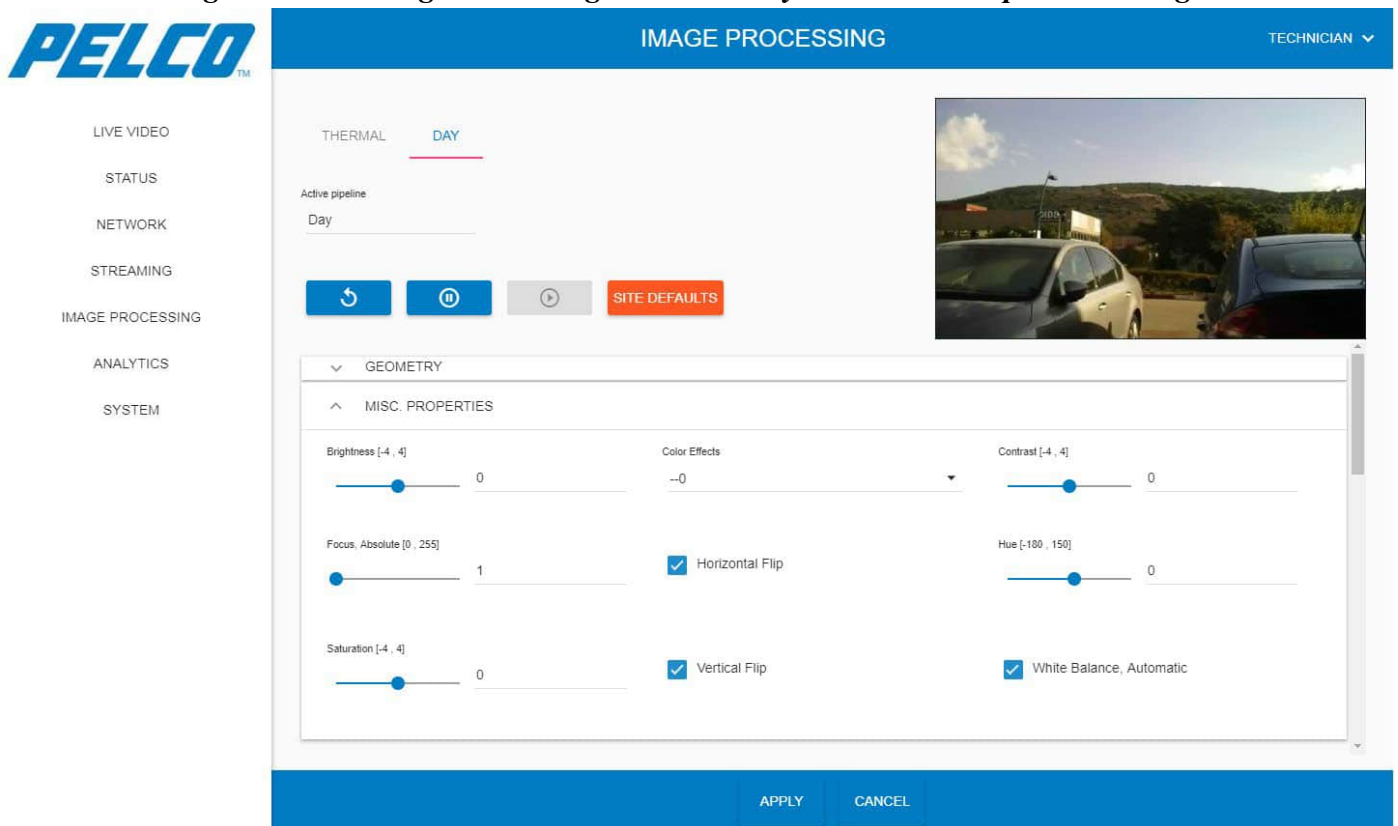

The Misc. Properties Settings option consists of the following detector parameters:

- **Brightness**
- **Color Effects**
- **Contrast**
- **Focus, Absolute:** 0: Automatic, 1: infinity (recommended).
- **Horizontal Flip**
- **Hue**
- **Saturation**
- **Vertical Flip**
- **White Balance, Automatic:** not active.

5.10 Analytics Window

The Analytics Window enables detecting and tracking movement within predefined ROIs, as well as for teaching the system where movement typically occurs.

1. Click **Analytics**. The Analytics window opens (all collapsed):

Figure 5-42: Analytics Window (all collapsed)

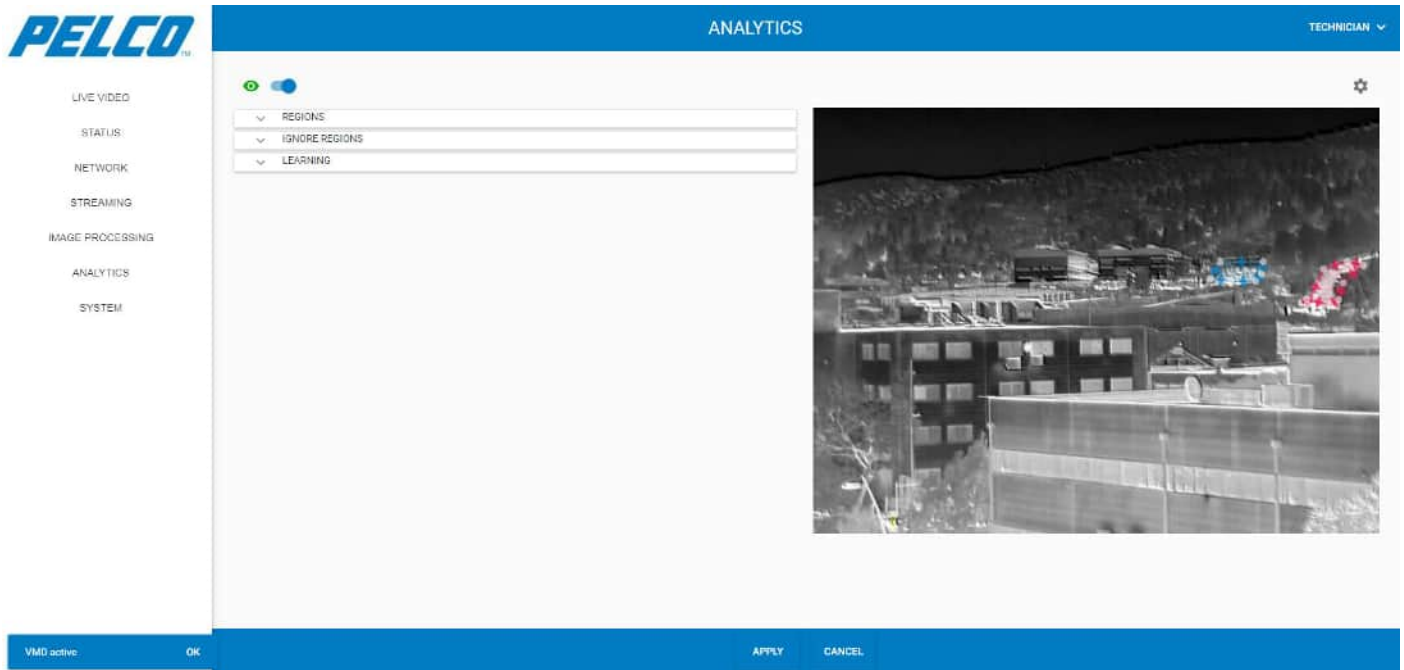

The Analytics window is comprised of three tabs:

- **Regions Tab:** enables marking of regions to detect movement (see Section 5.10.1).
- **Ignore Regions Tab:** enables marking of regions in which movement is ignored (see Section 5.10.2).
- **Learning Tab:** enables the system to learn the viewed scene and where movement typically occurs (see Section 5.10.3).

NOTE

When entering the Analytics window, either of the following messages is displayed on the lower-left corner of the screen, depending on whether VMD is active or disabled. Click **OK** to close these messages.



VMD disabled

OK

NOTE

To enable/disable viewing analytics, click  in the top-left corner of the screen to toggle between enable and disable. Click **APPLY** for the changes to take effect (click **CANCEL** to revert your changes).

5.10.1 Regions Tab

The Regions tab enables marking regions to detect movement.

1. Expand the **Regions** tab. The following opens:

Figure 5-43: Analytics Window - Regions Tab

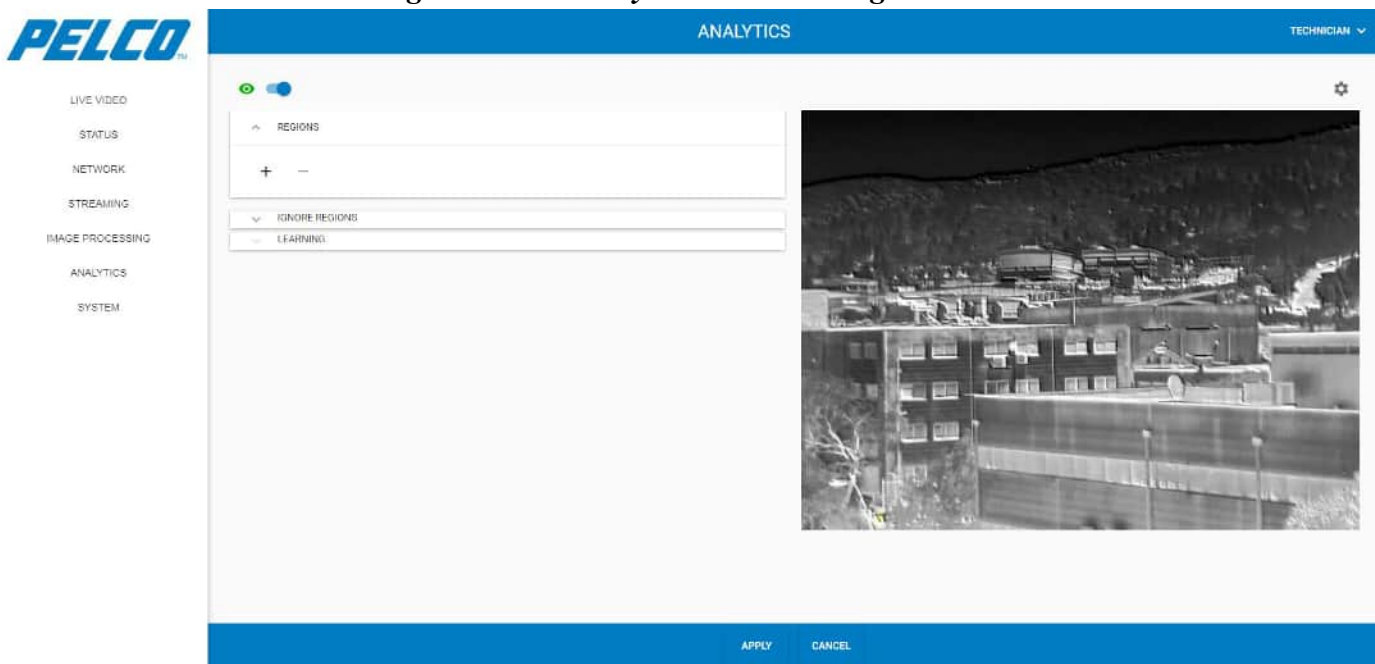

2. Click the + sign. The following opens (example):

Figure 5-44: Analytics Window - Regions Tab - Region Options

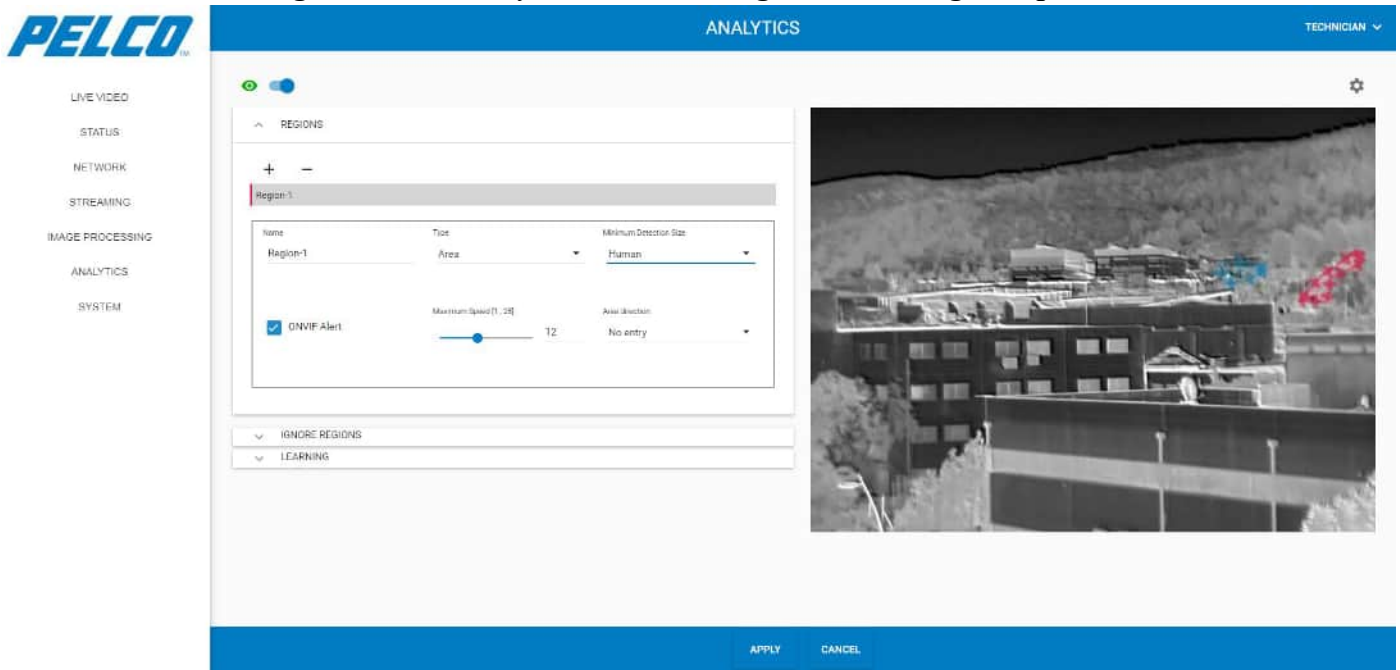

3. Click in the **Name** field and enter a region name.
4. Select region type from the following options:
 - Area – detection is done within a close frame.
 - Fence – detection is done for objects moving towards a predefined line.

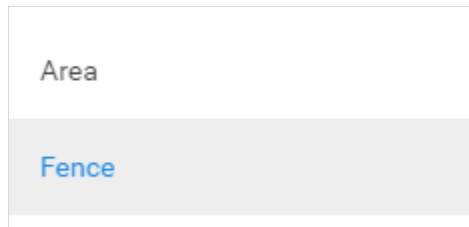

NOTE

Some region options change depending on the type of region selected.

5. Select the following parameters:

- **Minimum Detection Size:** determines the size and characters of the object to be detected.

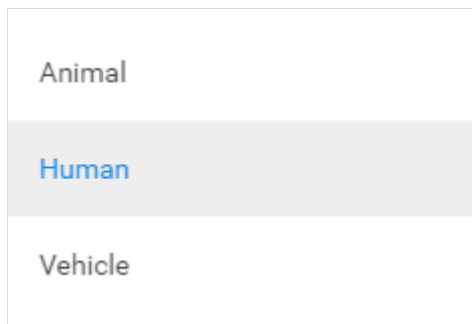

- **ONVIF Alert:** enabling receiving alerts which conform to ONVIF protocol.
- **Maximum Speed:** fastest speed that will be detected, in m/sec (default: 1 m/sec)
- **Area Direction:** determines the type of object movement (in relation to the region) that will be detected (this option is available when Area type region is selected)

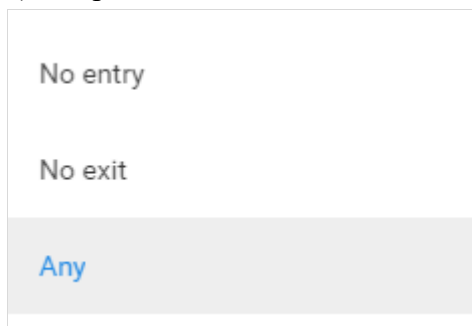

- **Fence direction:** determines the type of object movement (in relation to the fence line) that will be detected (this option is available when Fence type region is selected)

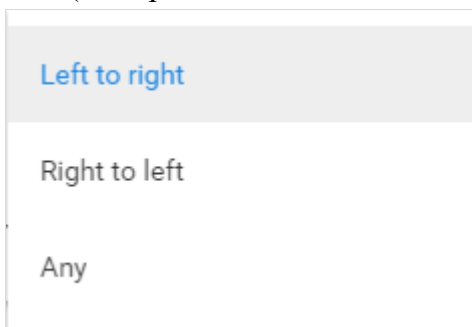

6. Click the live image to mark the region frame points.
7. Double click the region starting point to end the region marking.

Figure 5-45: Analytics Window - Regions Tab - Area ROI

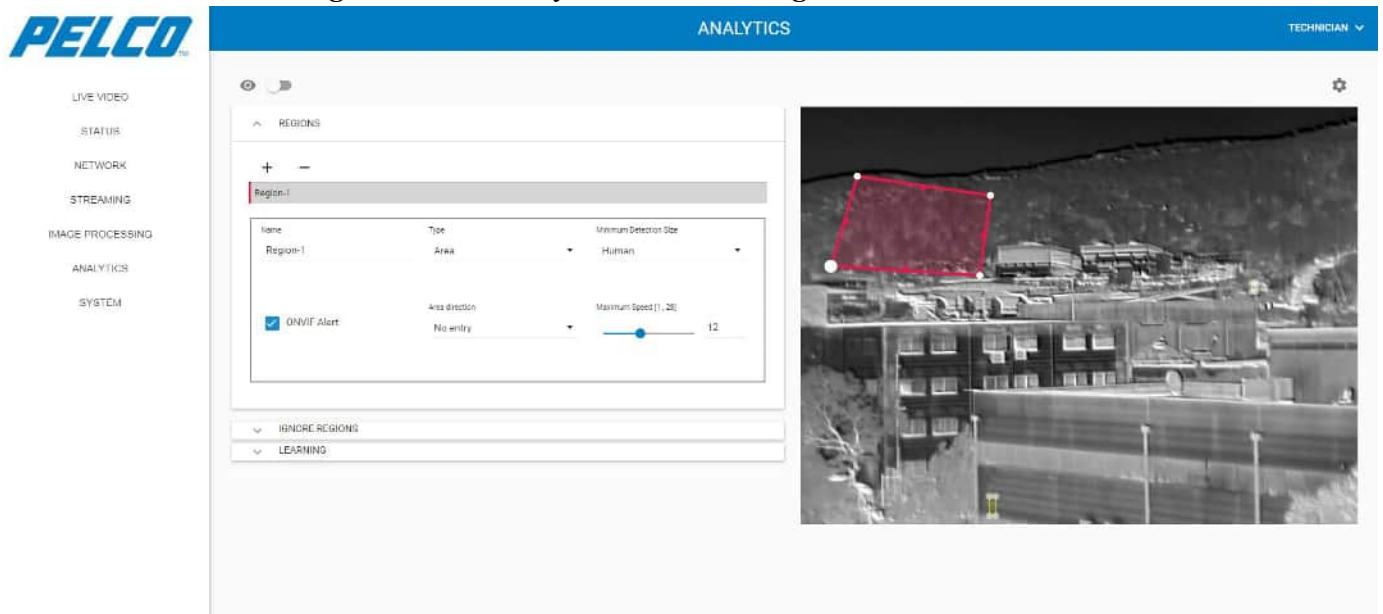
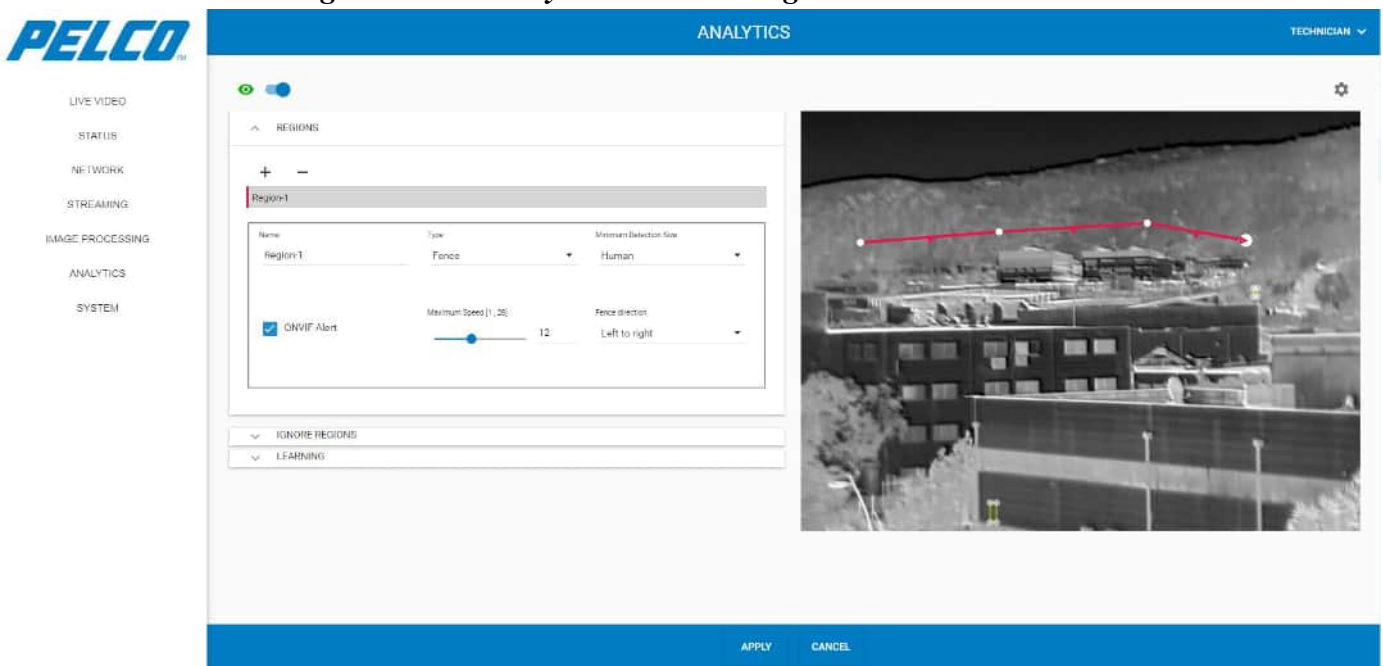

Figure 5-46: Analytics Window - Regions Tab - Fence ROI



NOTE

The color next to the region name corresponds with the color of the region marked on the image.

8. To delete a region definition: select the region (Region-1 or Region-2 in the example) and click the - sign.
9. Click **APPLY** for the changes to take effect (click **CANCEL** to revert your changes).

5.10.2 Ignore Regions Tab

The **Ignore Regions** tab enables marking regions in which movement is ignored. Expand the **Ignore Regions** tab. The following opens:

Figure 5-47: Analytics Window - Ignore Regions Tab

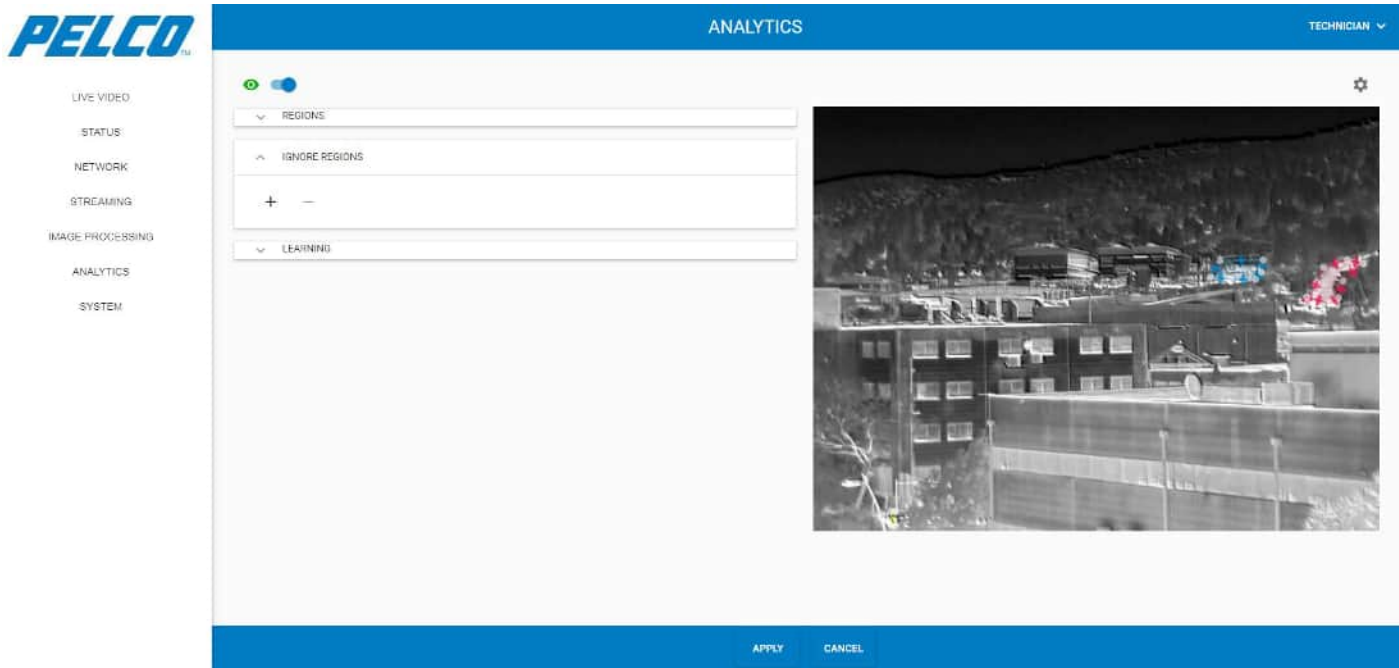

1. Click the + sign. The following opens (example):

Figure 5-48: Analytics Window - Ignore Regions Tab – Ignore Regions ROI (1 of 2)

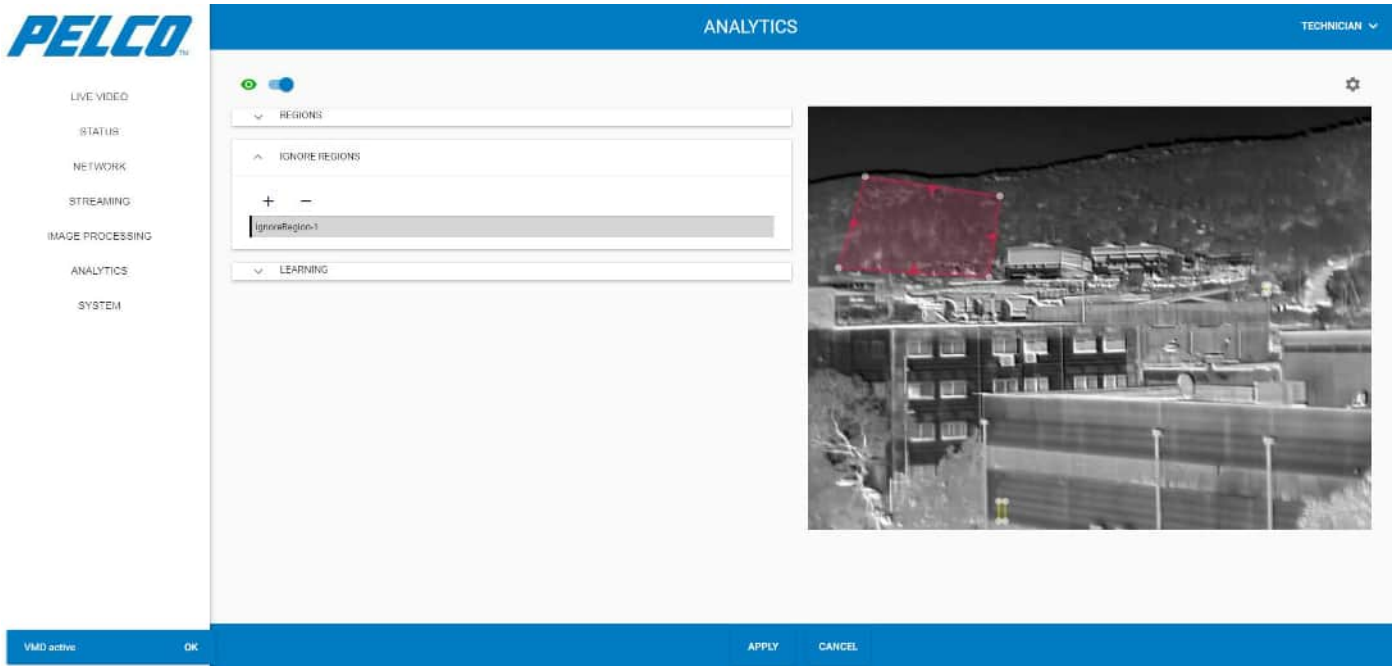

2. Click the live image to mark the Ignore Region frame points.
3. Double click the region starting point to end the Ignore Region marking.

Figure 5-49: Analytics Window - Ignore Regions Tab – Ignore Regions ROI (2 of 2)

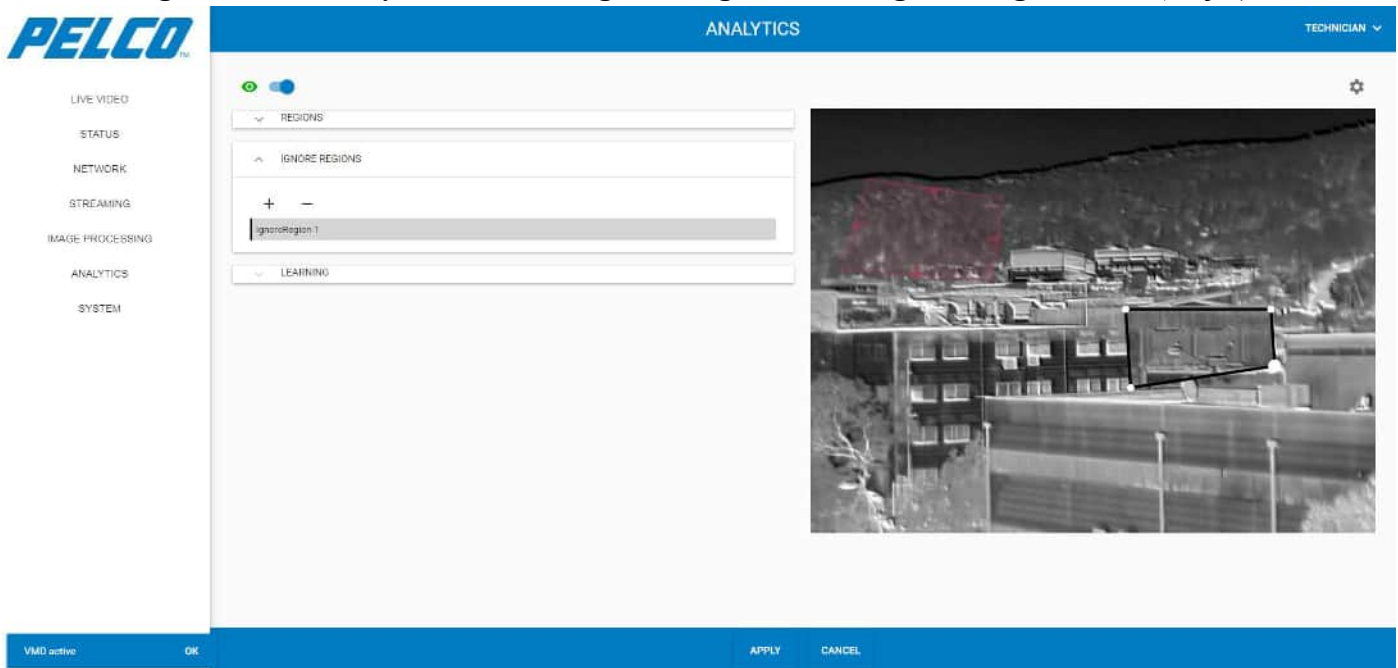

4. To delete an Ignore Region definition: select the ignore region (IgnoreRegion-1 or IgnoreRegion-2 in the example) and click the - sign.
5. Click **APPLY** for the changes to take effect (click **CANCEL** to revert your changes).

5.10.3 Learning Tab

The Learning tab enables the system to learn the scene and where movement typically occurs. Expand the **Learning** tab. The following opens:

Figure 5-50: Analytics Window - Learning Tab

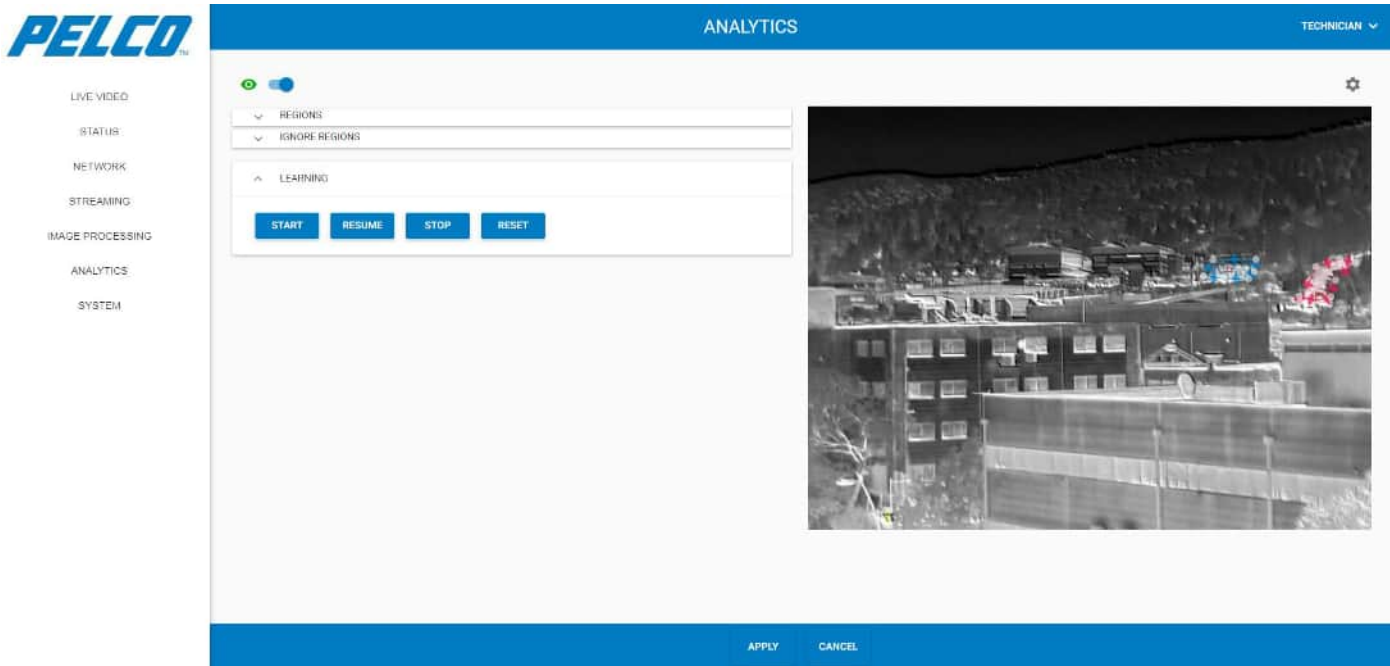

1. Click either of the following buttons:

- Click **START** to start the learning session.
- Click **RESUME** to resume the learning session after the Stop button was activated.
- Click **STOP** to stop the learning session (if, for example, unusual activity is occurring).
- Click **RESET** to delete the learning session in progress.

NOTE

VMD must be active (i.e., the toggle button in the top-left corner of the screen must appear like this: ) to start the learning session.

NOTE

When the Start button is pressed, the following message is displayed on the lower-left corner of the screen. Click **OK** to close this message.



5.10.4 Analytics Settings

Click  in the upper-right corner of the screen. The following opens:

Figure 5-51: Analytics Window - Analytics Settings



The Analytics Settings window consists of the following parameters:

- **ActiveBlockPercent:** Percentage of the block area that should be active in order to detect movement (default: 70%)
- **BlockSize:** minimum block size (default: 8)
- **Draw Region:** enabling drawing of region
- **Draw Target Box:** enabling frame overlay around the moving target
- **Draw Target Trail:** enabling trail showing the path the moving target has taken. The maximum trail length is determined by “MaxTargetTrailLength”
- **Initial Noise Level:** higher level reduces the effect of noise in a scene, but also reduces detection sensitivity (default: 6)
- **LearningTime:** length of time, in seconds, the learning session will run (default: 30 seconds)
- **MaxTargetTrailLength:** trail length, in FPS (default: 120 FPS). Will not display if “Draw Target Trail” is not enabled
- **Scene History:** minimum number of frames that are used for movement detection (default: 2)
- **TTL:** length of time, in seconds, a target will continue to be considered a target after it hasn't been seen (default: 2 seconds)
- **Track All Frame:** enabling tracking of target in entire image frame, not just in the ROI the object was detected in
- **Warning Time:** elapsed time, in seconds, until the system defines the identified object as a target (default: 0.4 seconds)

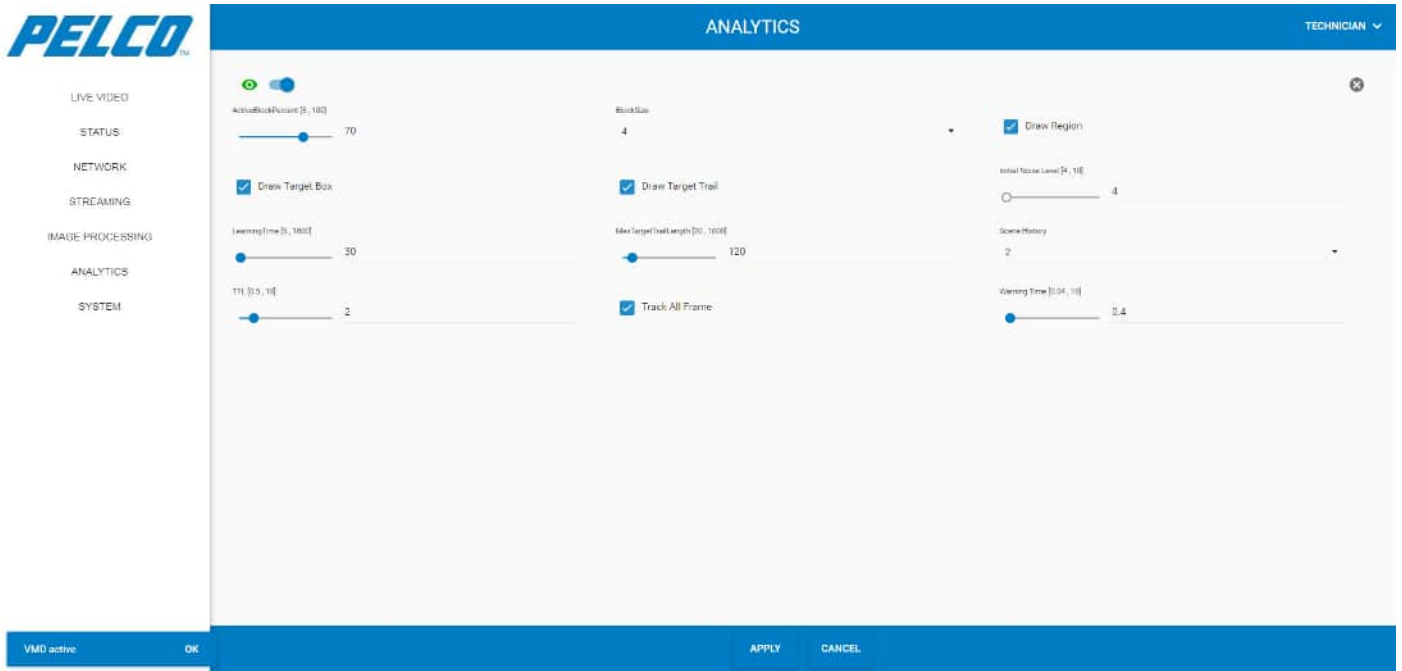
NOTE

To close the Analytics Settings screen, click  in the upper-right corner of the screen. Any changes that were made are retained.

5.11 System Window

The System Window consists of five tabs:

- [Admin Tab](#) (see Section 5.11.1)
- [Logs Tab](#) (see Section 5.11.2)
- [Date and Time Tab](#) (see Section 5.11.3)
- [File Upload Tab](#) (see Section 5.11.4)
- [User Management Tab](#) (see Section 5.11.5)

5.11.1 Admin Tab

Click **ADMIN**. The following opens:

Figure 5-52: System Window - Admin Tab

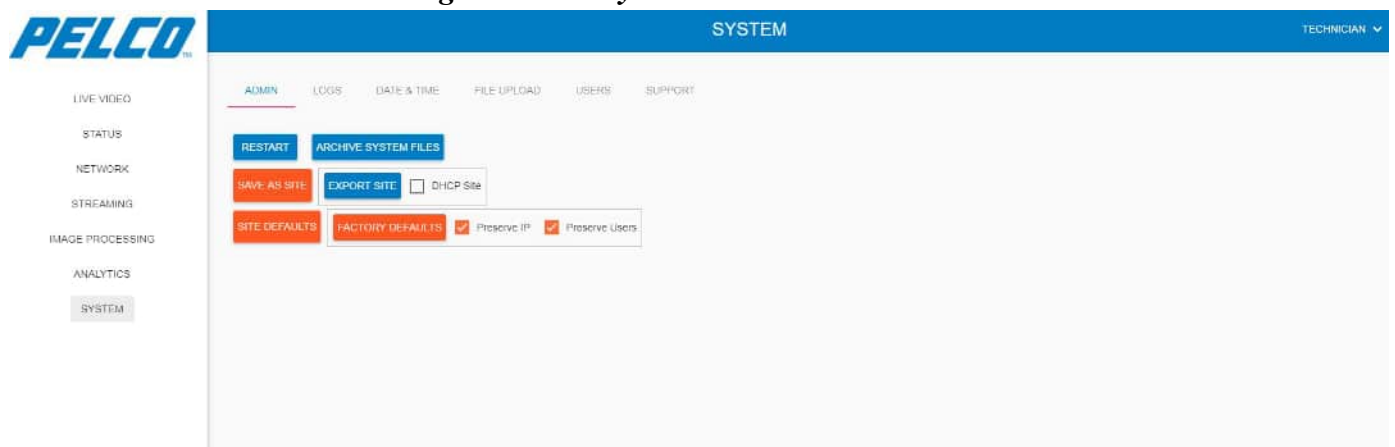

5.11.1.1 Restart

To completely restart the entire system:

1. Click **RESTART**. The following opens:

Figure 5-53: System Window - Admin Tab - Restart Approval

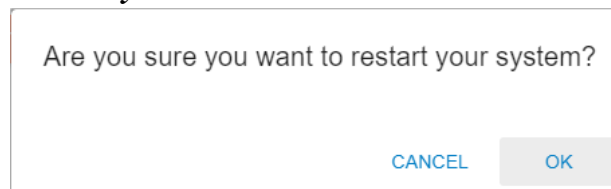

- Click **OK** to approve the system restart. The following opens, stating that the restart process could take a few minutes:

Figure 5-54: System Window - Admin Tab - Restart

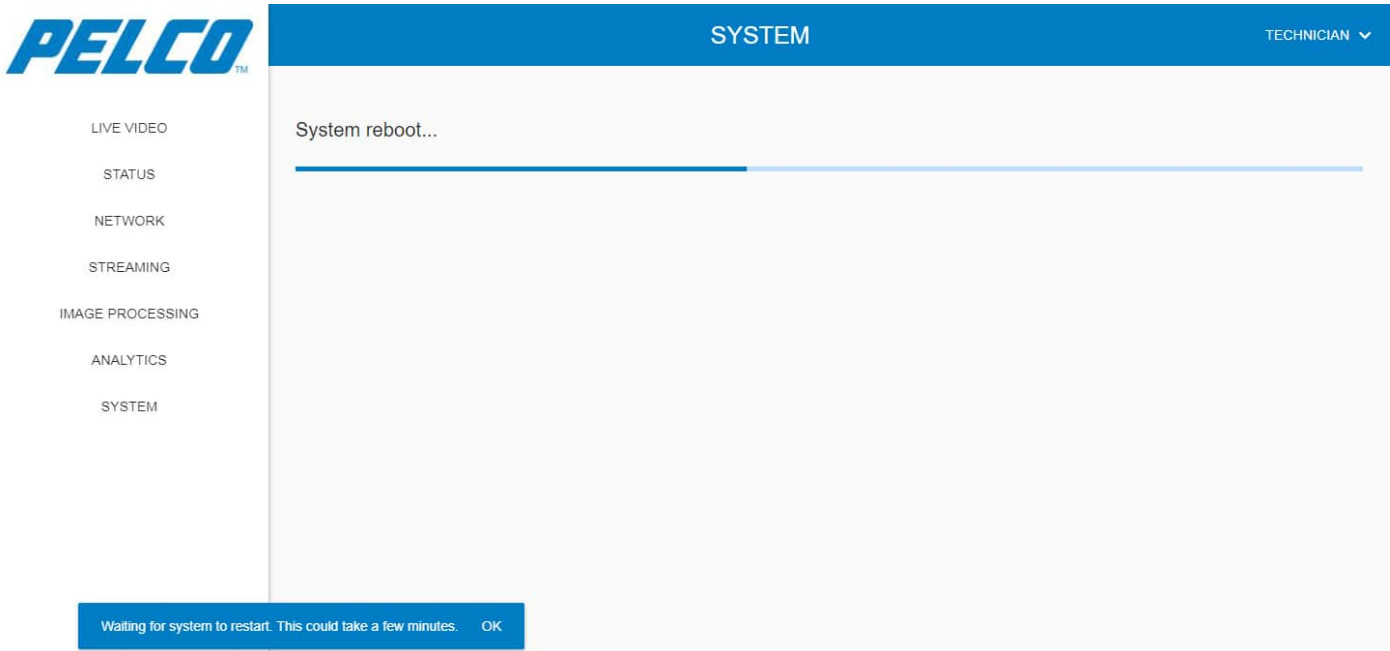

On completion, the following opens prompting that the restart is completed:



5.11.1.2 Archive System Files

To archive the entire system files:

- Click **ARCHIVE SYSTEM FILES**. The following opens, prompting that the archiving is in process:

Figure 5-55: System Window - Admin Tab - Archive System Files

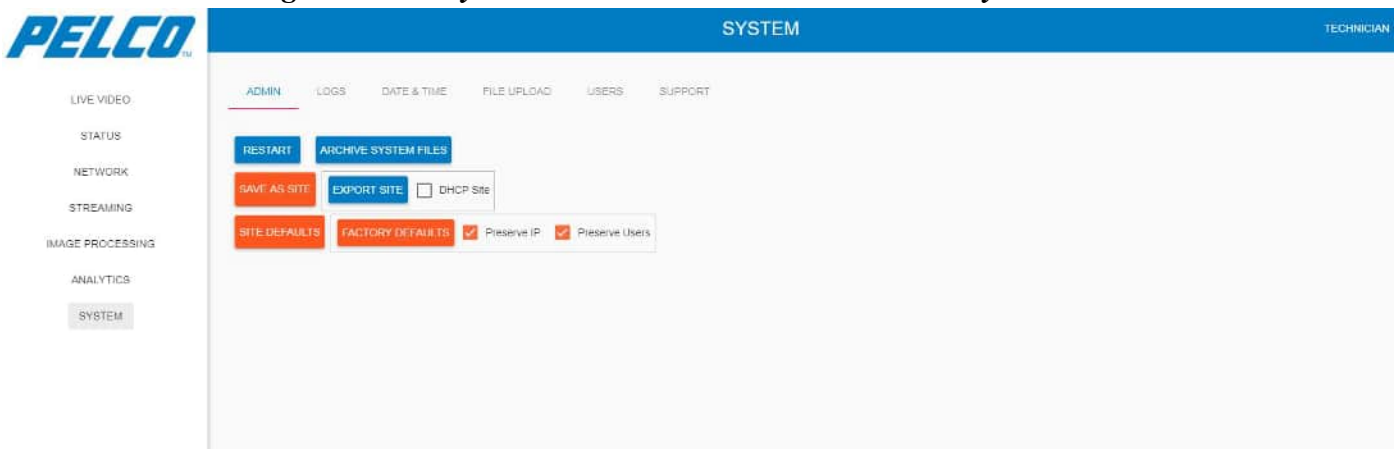

On completion, the following opens prompting to approve the download of the archived file:

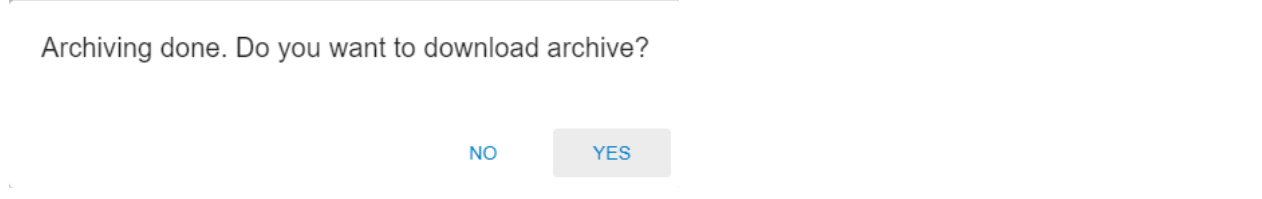

2. Click **Yes** to download the file. The file is downloaded and saved in your \Downloads folder. File name: **System-files.tgzx**.

5.11.1.3 Save As Site

To save the current settings of the camera and the GUI as site defaults:

1. Click **SAVE AS SITE**. The following opens:

Figure 5-56: System Window - Admin Tab - Save As Site Approval

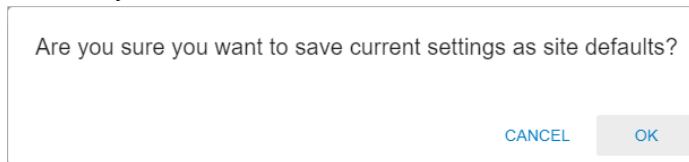

2. Click **OK** to proceed. The following opens, prompting that site defaults save is in process:

Figure 5-57: System Window - Admin Tab - Save As Site

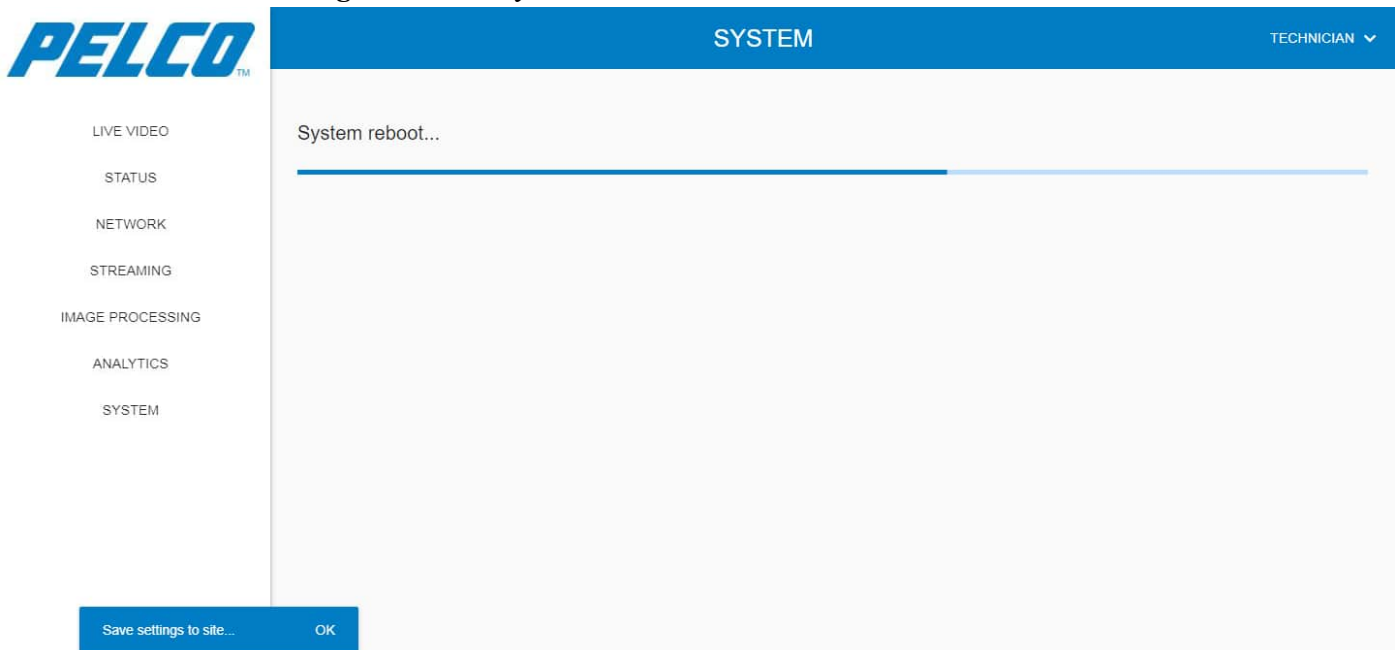

On completion, the following opens prompting that the site defaults are saved:



5.11.1.4 Export Site

To download an archived file that contain the site defaults:

1. Click **EXPORT SITE**. The following opens prompting to approve the site defaults download:

Figure 5-58: System Window - Admin Tab - Export Site Approval

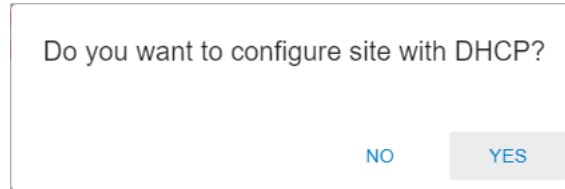

2. Click **Yes** to download the file with DHCP, *OR*:
Click **No** to download the file with a constant IP address.
The file is downloaded and saved in your \Downloads folder. File name:
site-defaults.tgzx.

5.11.1.5 Site Defaults

To revert system settings back to the site defaults settings:

1. Click **SITE DEFAULTS**. The following opens prompting to approve the revert process:

Figure 5-59: System Window - Admin Tab - Site Defaults Approval

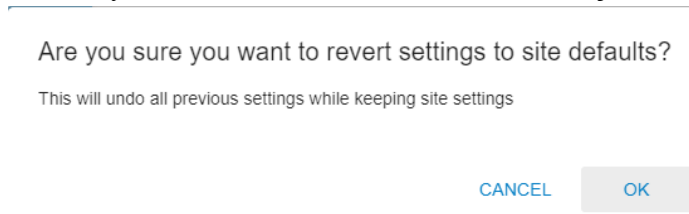

2. Click **OK**. The following opens, prompting that the site defaults restoration is in process:

Figure 5-60: System Window - Admin Tab - Site Defaults

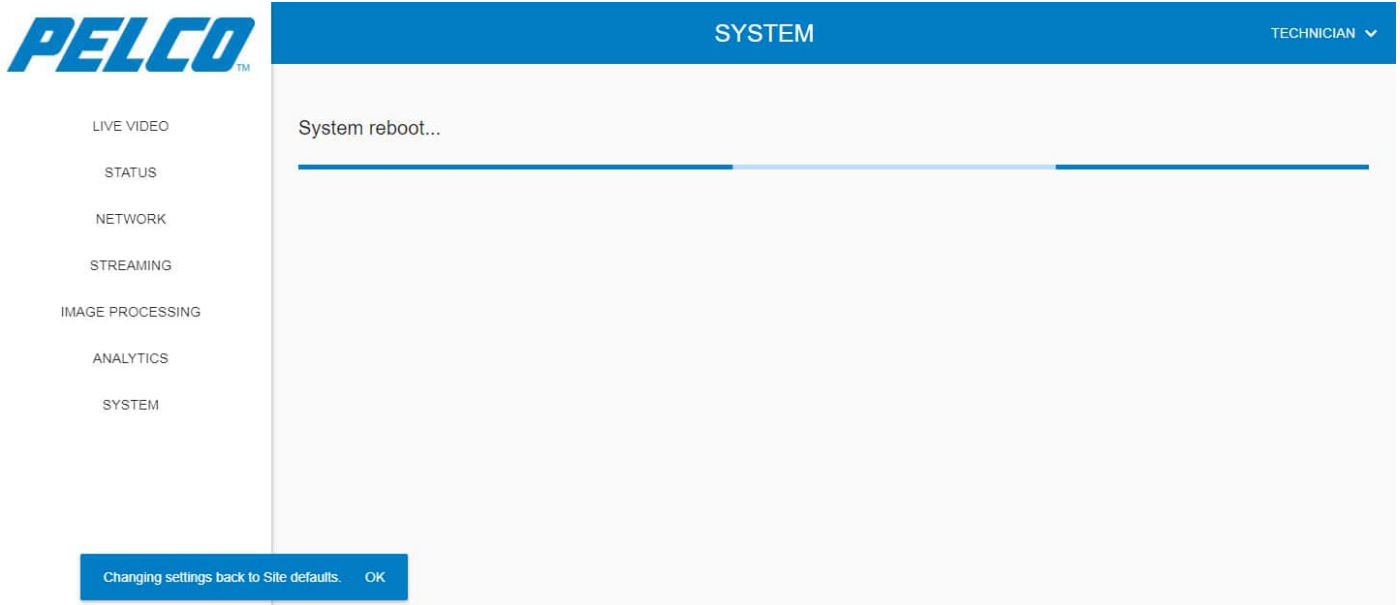

On completion, the following opens prompting that the site defaults are saved:



5.11.1.6 Factory Defaults

To revert settings to factory defaults:

1. Click **FACTORY DEFAULTS**. The following opens prompting to approve the revert process:

Figure 5-61: System Window - Admin Tab - Factory Defaults Approval

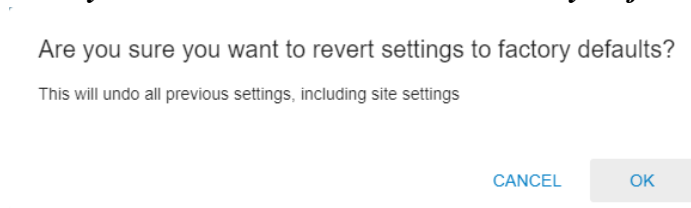

NOTE

If **Preserve IP** is unchecked, the system will restart with the default IP.

If **Preserve Users** is unchecked, all users will be deleted upon system restart.



2. Click **OK**. The following opens, prompting that the factory defaults restoration is in process:

Figure 5-62: System Window - Admin Tab - Factory Defaults

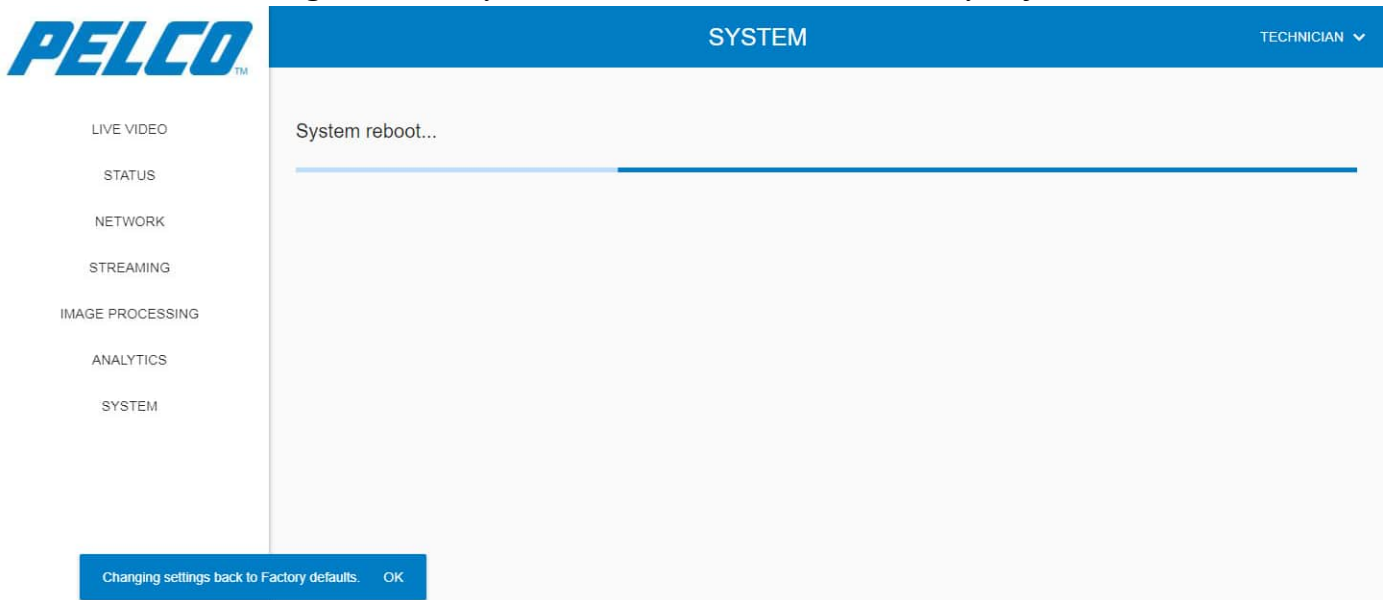

On completion, the following opens prompting that the factory defaults are saved:





5.11.2 Logs Tab

The Status tab allows downloading data files from the Sarix TI Camera. This is mainly useful when troubleshooting possible Sarix TI Camera malfunctions by Pelco's technical support team.

1. Click **System** and select **Log Files**. The Status tab displays a list of logs (example):

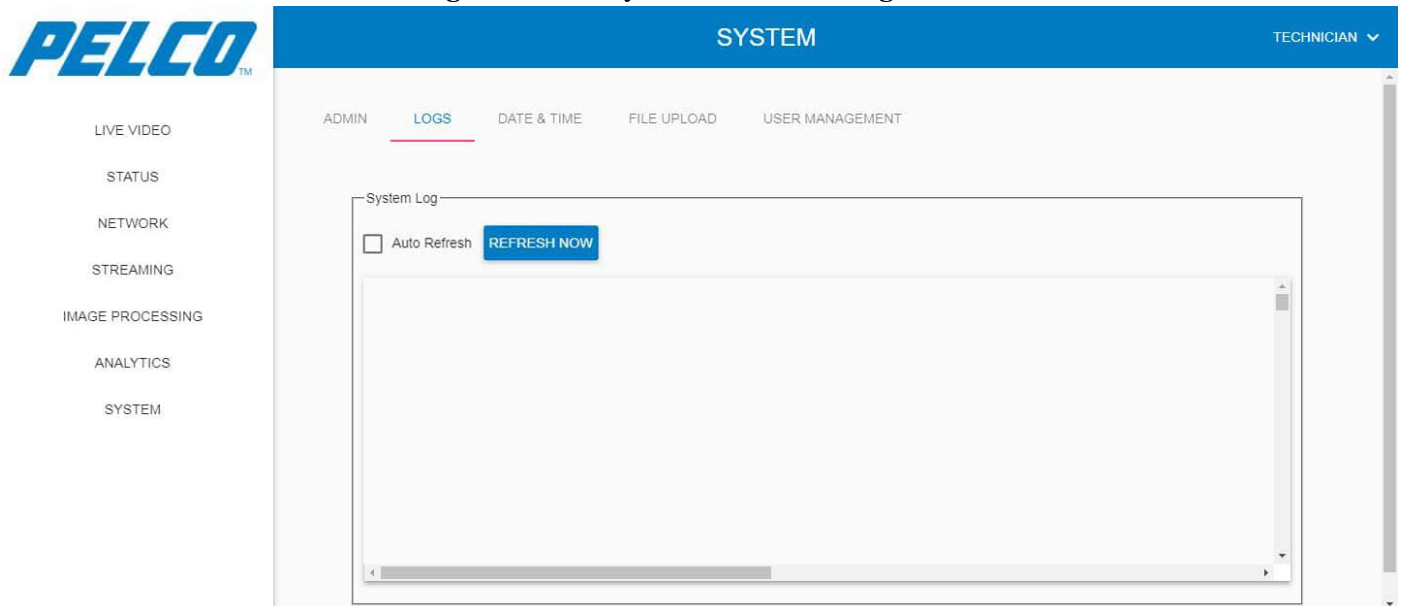
Figure 5-63: System Window - Logs Tab



2. To refresh the list click  .

5.11.3 Date and Time Tab

CAUTION

Time synchronization is extremely important for the ONVIF handshake. If the time is not correctly synchronized, the camera may not connect over ONVIF.

The Date and Time tab allows synchronizing of the Sarix TI Camera time and date according to several methods:

Click **System** and select the **DATE & TIME** tab. The Date & Time tab opens:

Figure 5-64: System Window - Date and Time Tab

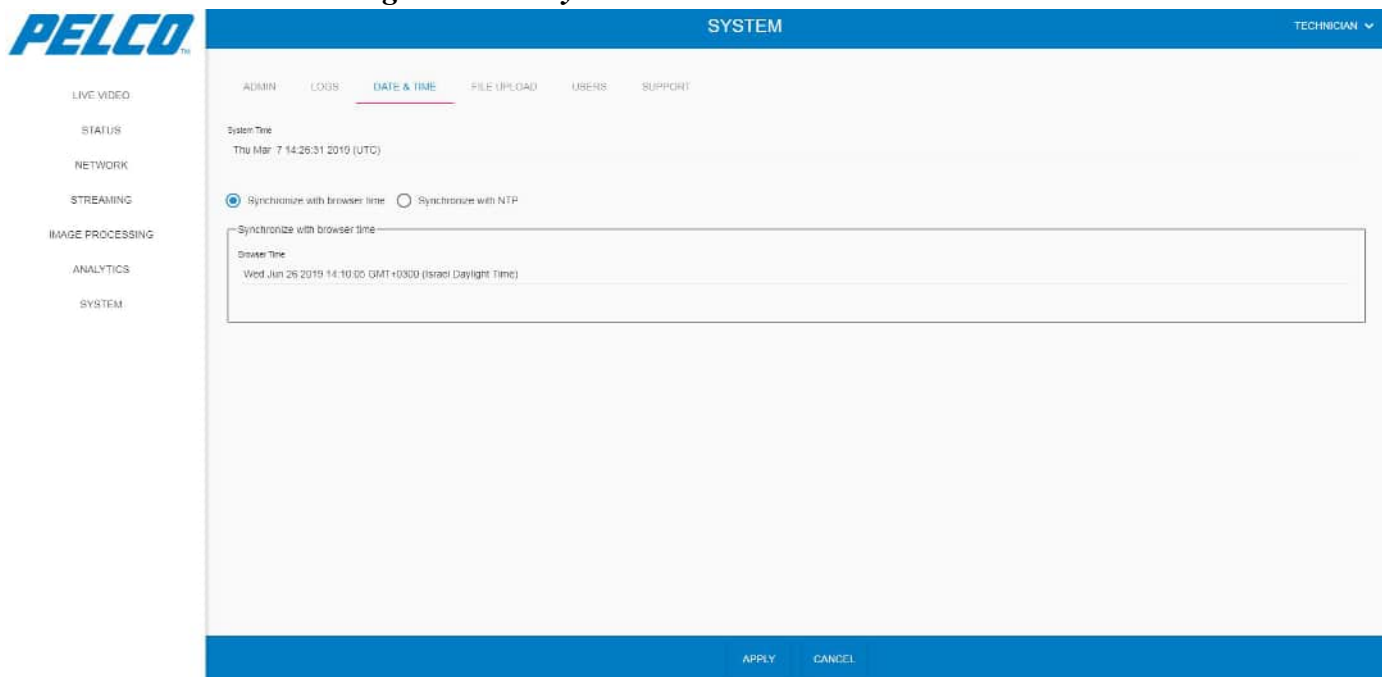

5.11.3.1 Synchronizing with Browser Time

Select the **Synchronize with browser time** option. The following opens:

Figure 5-65: System Window - Date and Time Tab - Synchronizing with Browser Time

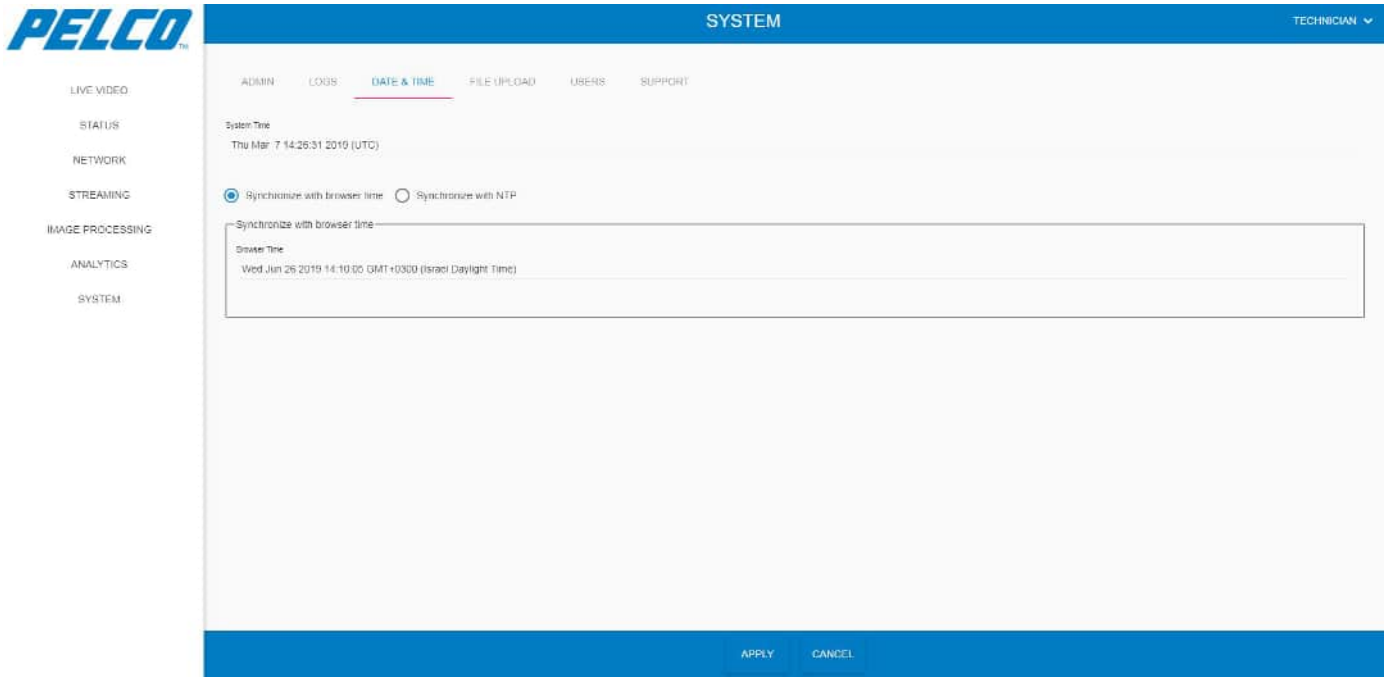

5.11.3.2 Synchronizing with NTP

Select the **Synchronize with NTP** option. The following opens:

Figure 5-66: System Window - Date and Time Tab - Synchronizing with NTP

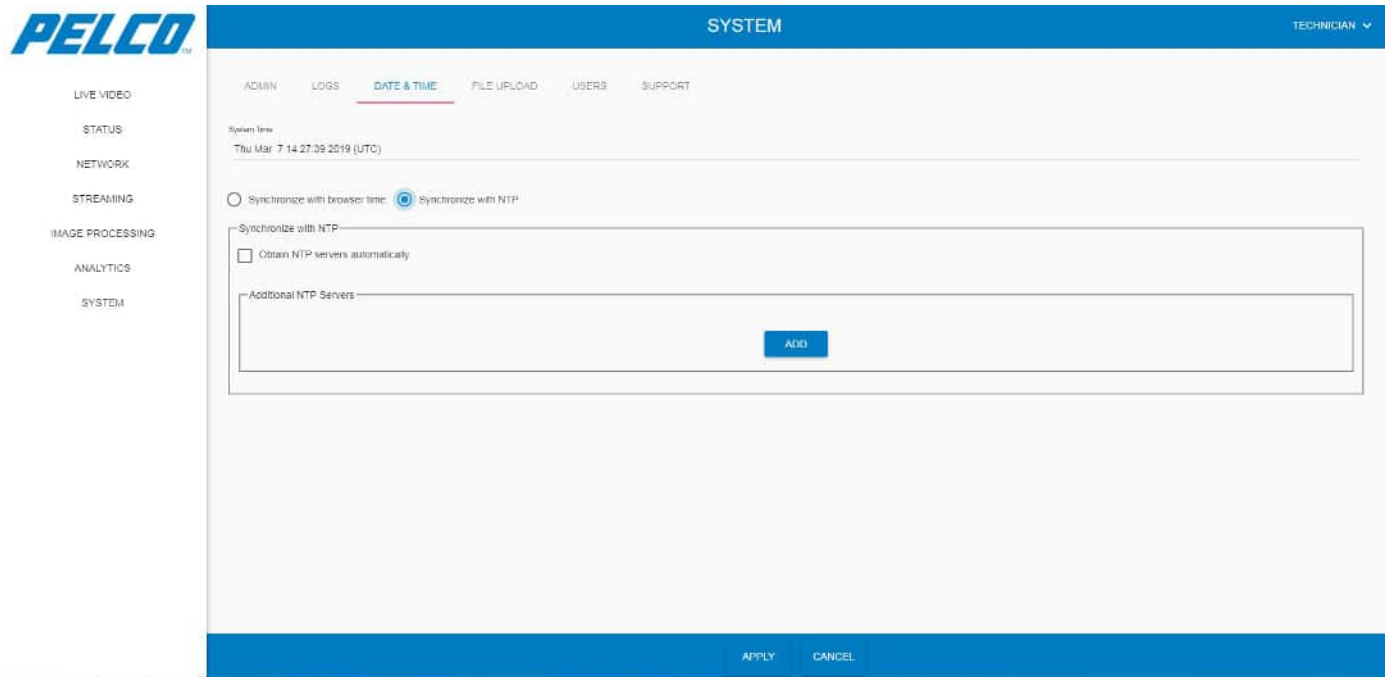

5.11.4 File Upload Tab

The File Upload tab allows updating your Sarix TI Camera with FM/SW.

1. Click **System** and select the **FILE UPLOAD** tab. The File Upload tab opens:

Figure 5-67: System Window - File Upload Tab

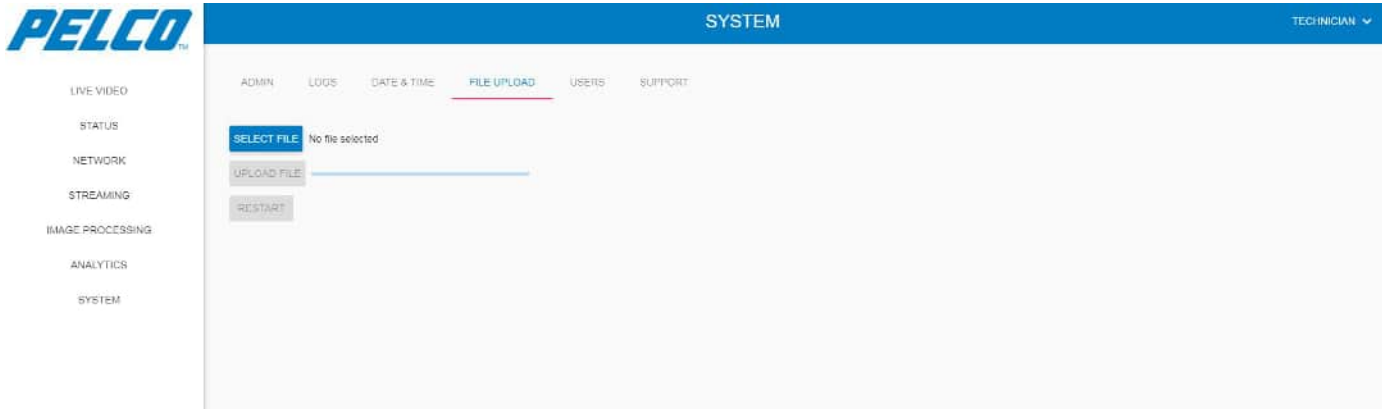

2. Click **SELECT FILE** to browse and select the required FM/SW file (*.tgzx file format).
3. Click **UPLOAD FILE**. The uploading process is started. On completion, the **RESTART** button is valid.
4. Click **RESTART** to validate the Sarix TI Camera with the FM/SW uploading process.

5.11.5 User Management Tab

The User Management tab is used to manage user's login permissions.

Click **System** and select the **User Management** tab. The User Management tab opens:

Figure 5-68: System Window - User Management Tab

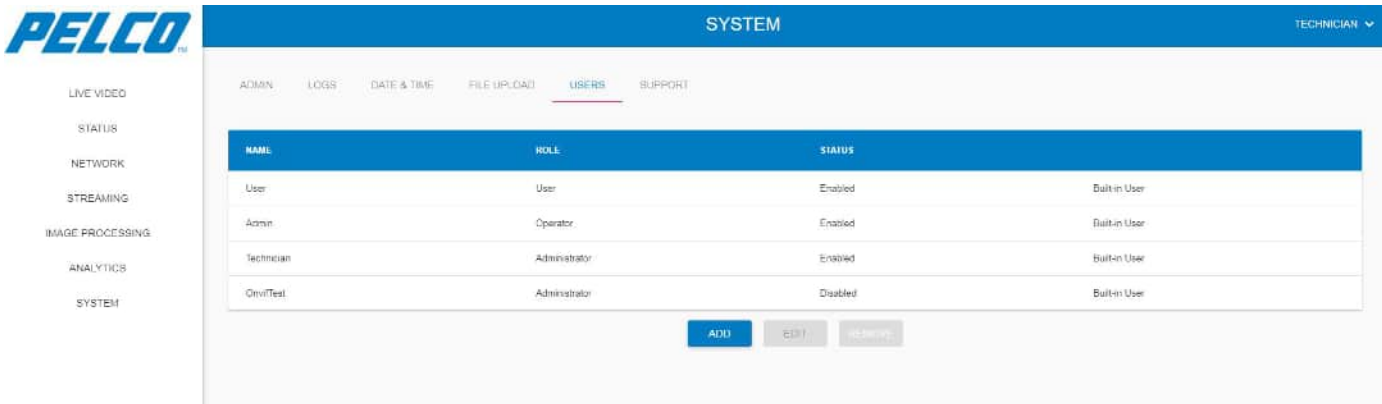

5.11.5.1 Adding a User

To add a new user:

1. Click **ADD**. The following opens:

Figure 5-69: System Window - User Management Tab - Adding a User

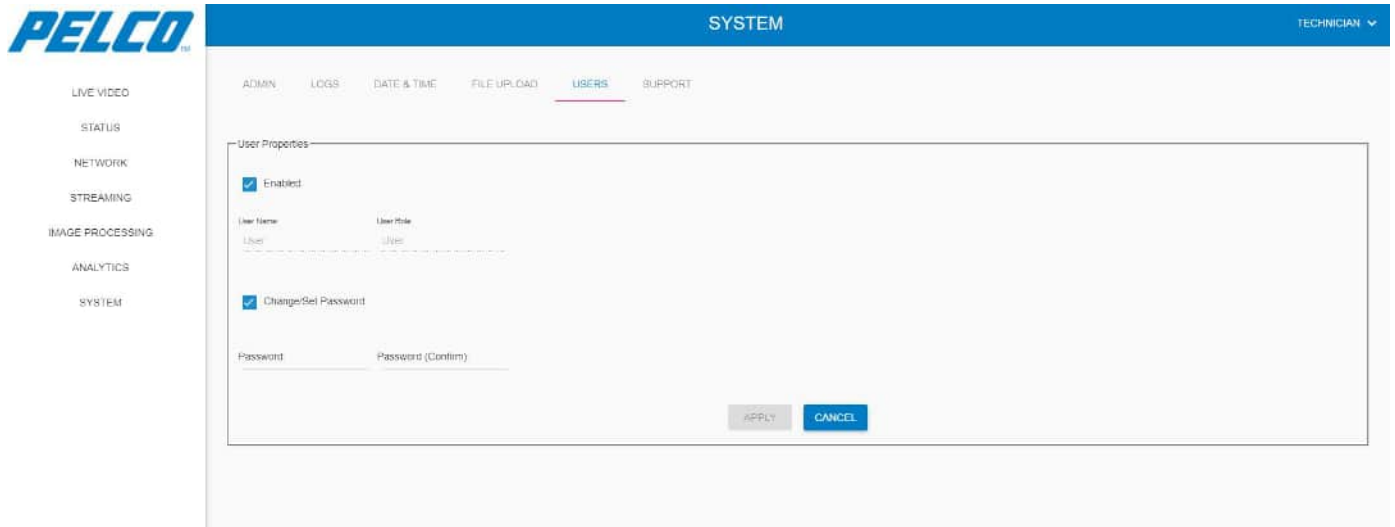

2. Enter the **User Name**.
3. From the **User Role** drop-down list select the usage-level of the user:

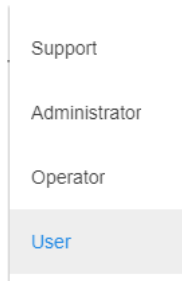

4. Click **APPLY** to validate the changes.

5.11.5.2 Editing User Details

1. Select a user and click **EDIT**.

Figure 5-70: System Window - User Management Tab - Editing User Details

The screenshot shows the PELCO SYSTEM web interface. The top navigation bar includes the PELCO logo, the word "SYSTEM", and a user profile dropdown for "TECHNICIAN". Below this is a menu with options: ADMIN, LOGS, DATE & TIME, FILE UPLOAD, and USER MANAGEMENT (which is highlighted). On the left, a sidebar lists various system functions: LIVE VIDEO, STATUS, NETWORK, STREAMING, IMAGE PROCESSING, ANALYTICS, and SYSTEM. The main content area displays a table of users:

NAME	ROLE	STATUS	
User	User	Enabled	Built-in User
Admin	Operator	Enabled	Built-in User
Technician	Administrator	Enabled	Built-in User
Support	Support	Enabled	Built-in User

Below the table are three buttons: **ADD**, **EDIT**, and **REMOVE**.

2. Change the user details.
3. Click **APPLY** to validate the changes.

5.12 Logging Out from the Web GUI

4. Stop any action, currently in process.
5. From the upper-right drop-down menu select **Logout**:

Figure 5-71: Logging Out from the Web GUI - Drop Down Menu

The screenshot shows a vertical drop-down menu with the following options: "Technician", "Change password", and "Logout". The "Logout" option is highlighted with a grey background.

The user is logged out from the program and the Status window re-opens (see [Figure 5-2](#)).

6. Maintenance

This chapter provides the Sarix TI Series Camera preventive maintenance instructions.

The chapter consists of the following sections:

- Section [6.1: Visual Inspection](#)
- Section [6.2: Cleaning](#)

6.1 Visual Inspection

1. Visually inspect the camera and check the physical condition of the camera's chassis and lens.
2. Check the physical condition of the cable (torn, over-bending, damaged isolation, bent or immersed pins).

6.2 Cleaning

CAUTION

Do not use any chemicals for cleaning the Sarix TI Camera. Failure to comply could result in damage to the Sarix TI Camera optical-lens and/or its surfaces.

1. Clean the Sarix TI Camera using wipes approved for optical equipment.
2. Clean any stains using a cotton-cloth, slightly dumped in tap water.

7. Ordering Information

This chapter provides information for purchasing the Sarix TI Series Camera and accessories. The chapter consists of the following sections:

7.1 Ordering Information

Table 7-1: Ordering Information for 30Hz Camera

	Lens Type	Part Number
17 μ 640x480	14.2mm f/1.2, Athermalized, Fixed Focus	TI2614
	35mm f/1.2, Athermalized, Fixed Focus	TI2635
	50mm f/1.2, Athermalized, Fixed Focus	TI2650
17 μ 384x288	14.2mm f/1.2,Athermalized, Fixed Focus	TI2314
	35mm f/1.2,Athermalized, Fixed Focus	TI2335
	50mm f/1.2,Athermalized, Fixed Focus	TI2350

Table 7-2: Ordering Information for 9Hz Camera

	Lens Type	Part Number
17 μ 640x480	14.2mm f/1.2, Athermalized, Fixed Focus	TI2614-1
	35mm f/1.2, Athermalized, Fixed Focus	TI2635-1
	50mm f/1.2, Athermalized, Fixed Focus	TI2650-1
17 μ 384x288	14.2mm f/1.2,Athermalized, Fixed Focus	TI2314-1
	35mm f/1.2,Athermalized, Fixed Focus	TI2335-1
	50mm f/1.2,Athermalized, Fixed Focus	TI2350-1

7.2 Ordering Accessories

Table 7-3: Ordering Accessories

	Part Number
Accessories:	
SARIX TI POW cable 50 FT	TICAB-P50
Wall Mount Accessories:	
SARIX TI Wall Mount	TIWM
SARIX TI Pole Adapter REQ Wall MNT	TIPA

8. Index

This chapter provides a list, arranged in alphabetical order, of keywords found throughout this manual.

A

Abbreviations · 1-11

C

Certificates

Request · 5-19

Self-Signed Request · 5-19

Uploading a Certificate · 5-20

Cleaning · 6-63

D

Day Tab · 5-12, 5-25

Main Stream · 5-25

Secondary Stream · 5-27

Disable Camera · 5-13

E

Enable Camera · 5-14

F

Features · 2-14

G

General Configuration Tab · 5-28

Getting Started

Changing Password · 5-5

Image Processing Window · 5-29

Live View Window · 5-7

Logging Into GUI · 5-3

Logging Out · 5-62

Main Window · 5-6

Network Window · 5-15

Status Window · 5-8

Streaming Window · 5-21

System Window · 5-51

GUI · 2-17

I

Image Processing Window · 5-29

Day Tab · 5-37

Day Tab Geometry Settings · 5-38

Day Tab Misc Properties Settings · 5-39

Thermal Tab · 5-29

Thermal Tab Advanced Settings · 5-33

Thermal Tab Basic Settings · 5-30

Thermal Tab Color Processing Settings · 5-34

Thermal Tab Gain Control Settings · 5-32

Thermal Tab Signal Processing Settings · 5-31

Installation · 4-1

Camera Installation · 4-2

Unpacking · 4-1

Installing Camera · 4-2

IP PoE Cable · 4-6

Mechanical Interface Preparation · 4-2, 4-3

Pole Mount Configuration · 4-5

Wall Mount Configuration · 4-4

L

Live View Window · 5-7

LOF · 1-7

Logging Out · 5-62

Login · 5-3

LOT · 1-7

M

Main Window Overview · 5-6

Maintenance · 6-63

Cleaning · 6-63

Visual Inspection · 6-63

N

Network Window · 5-15

Certificates · 5-19

HTTPS Connection · 5-17

IP Address · 5-16

IP Address - Auto · 5-16

Manual DNS Server Address · 5-17

ONVIF Service · 5-18

Resetting Network Settings · 5-18

O

Operation · 5-1

Ordering Info · 7-64

Overview · 2-13, 2-14

Features · 2-14

GUI · 2-17

Physical Description · 2-15

Specifications · 2-18

P

Password Change · 5-5

Physical Description · 2-15

R

Revisions · 1-1

S

Safety · 3-1

Safety Conventions · 3-1

Safety During Installation · 3-2

Safety During Maintenance · 3-2

Safety Instructions

Conventions · 3-1

Installation · 3-2

Maintenance · 3-2

Scope · 1-12

Specifications · 2-18

CMOS Camera · 2-20

Configurations · 2-19

System Specifications · 2-18

Thermal Camera · 2-20

Status Window · 5-8

Status Window Overview

Day Tab · 5-12

Disable Camera · 5-13

Enable Camera · 5-14

System Tab · 5-9

Thermal Tab · 5-10

Streaming Window · 5-21

Day Tab · 5-25

General Configuration Tab · 5-28

Thermal Tab · 5-21

System Tab · 5-9

System Window · 5-51

Admin Tab · 5-51

Admin Tab - Archive System Files · 5-52

Admin Tab - Export Site · 5-54

Admin Tab - Factory Defaults · 5-55

Admin Tab - Restart · 5-51

Admin Tab - Save As Site · 5-53

Admin Tab - Site Defaults · 5-54

Date & Time Tab · 5-58

Date & Time Tab - Sync with Browser · 5-59

Date & Time Tab - Sync with NTP · 5-59

File Upload Tab · 5-60

Logs Tab · 5-57

User Management Tab · 5-60

User Management Tab - Adding a User · 5-61

User Management Tab - Editing a User · 5-62

T

Thermal Tab · 5-10, 5-21

Main Stream · 5-22

Secondary Stream · 5-24

[TOC · 1-2](#)

V

Visual Inspection · 6-63

U

Unpacking · 4-1



Pelco, Inc.
625 W. Alluvial Ave.
Fresno, CA 93711
Tel. +1 559-292-1981
www.pelco.com

Pelco, the Pelco logo, and other trademarks associated with Pelco products referred to in this publication are trademarks of Pelco, Inc. or its affiliates. ONVIF and the ONVIF logo are trademarks of ONVIF Inc. All other product names and services are the property of their respective companies. Product specifications and availability are subject to change without notice.

© Copyright 2019, Pelco, Inc. All rights reserved.