



Ultra High Definition (UHD) Decoder

Quick Start Guide

Legal Information

About this Document

- This Document includes instructions for using and managing the Product. Pictures, charts, images and all other information hereinafter are for description and explanation only.
- The information contained in the Document is subject to change, without notice, due to firmware updates or other reasons. Please find the latest version of the Document at the Hikvision website (<https://www.hikvision.com>). Unless otherwise agreed, Hangzhou Hikvision Digital Technology Co., Ltd. or its affiliates (hereinafter referred to as "Hikvision") makes no warranties, express or implied.
- Please use the Document with the guidance and assistance of professionals trained in supporting the Product.

About this Product

This product can only enjoy the after-sales service support in the country or region where the purchase is made.

Acknowledgment of Intellectual Property Rights

- Hikvision owns the copyrights and/or patents related to the technology embodied in the Products described in this Document, which may include licenses obtained from third parties.
- Any part of the Document, including text, pictures, graphics, etc., belongs to Hikvision. No part of this Document may be excerpted, copied, translated, or modified in whole or in part by any means without written permission.
- **HIKVISION** and other Hikvision's trademarks and logos are the properties of Hikvision in various jurisdictions.
- Other trademarks and logos mentioned are the properties of their respective owners.
- **HDMI**[™] The terms HDMI and HDMI High-Definition Multimedia Interface, and the HDMI Logo are trademarks or registered trademarks of HDMI Licensing Administrator, Inc. in the United States and other countries.

LEGAL DISCLAIMER

- TO THE MAXIMUM EXTENT PERMITTED BY APPLICABLE LAW, THIS DOCUMENT AND THE PRODUCT DESCRIBED, WITH ITS HARDWARE, SOFTWARE AND FIRMWARE, ARE PROVIDED "AS IS" AND "WITH ALL FAULTS AND ERRORS". HIKVISION MAKES NO WARRANTIES, EXPRESS OR IMPLIED, INCLUDING WITHOUT LIMITATION, MERCHANTABILITY, SATISFACTORY QUALITY, OR FITNESS FOR A PARTICULAR PURPOSE. THE USE OF THE PRODUCT BY YOU IS AT YOUR OWN RISK. IN NO EVENT WILL HIKVISION BE LIABLE TO YOU FOR ANY SPECIAL, CONSEQUENTIAL, INCIDENTAL, OR INDIRECT DAMAGES, INCLUDING, AMONG OTHERS, DAMAGES FOR LOSS OF BUSINESS PROFITS, BUSINESS INTERRUPTION, OR LOSS OF DATA, CORRUPTION OF SYSTEMS, OR LOSS OF DOCUMENTATION, WHETHER BASED ON BREACH OF CONTRACT, TORT (INCLUDING NEGLIGENCE), PRODUCT LIABILITY, OR OTHERWISE, IN CONNECTION WITH THE USE OF THE PRODUCT, EVEN IF HIKVISION HAS BEEN ADVISED OF THE POSSIBILITY OF SUCH DAMAGES OR LOSS.
- YOU ACKNOWLEDGE THAT THE NATURE OF THE INTERNET PROVIDES FOR INHERENT SECURITY RISKS, AND

HIKVISION SHALL NOT TAKE ANY RESPONSIBILITIES FOR ABNORMAL OPERATION, PRIVACY LEAKAGE OR OTHER DAMAGES RESULTING FROM CYBER-ATTACK, HACKER ATTACK, VIRUS INFECTION, OR OTHER INTERNET SECURITY RISKS; HOWEVER, HIKVISION WILL PROVIDE TIMELY TECHNICAL SUPPORT IF REQUIRED.

- YOU AGREE TO USE THIS PRODUCT IN COMPLIANCE WITH ALL APPLICABLE LAWS, AND YOU ARE SOLELY RESPONSIBLE FOR ENSURING THAT YOUR USE CONFORMS TO THE APPLICABLE LAW. ESPECIALLY, YOU ARE RESPONSIBLE, FOR USING THIS PRODUCT IN A MANNER THAT DOES NOT INFRINGE ON THE RIGHTS OF THIRD PARTIES, INCLUDING WITHOUT LIMITATION, RIGHTS OF PUBLICITY, INTELLECTUAL PROPERTY RIGHTS, OR DATA PROTECTION AND OTHER PRIVACY RIGHTS. YOU SHALL NOT USE THIS PRODUCT FOR ANY PROHIBITED END-USES, INCLUDING THE DEVELOPMENT OR PRODUCTION OF WEAPONS OF MASS DESTRUCTION, THE DEVELOPMENT OR PRODUCTION OF CHEMICAL OR BIOLOGICAL WEAPONS, ANY ACTIVITIES IN THE CONTEXT RELATED TO ANY NUCLEAR EXPLOSIVE OR UNSAFE NUCLEAR FUEL-CYCLE, OR IN SUPPORT OF HUMAN RIGHTS ABUSES.
- IN THE EVENT OF ANY CONFLICTS BETWEEN THIS DOCUMENT AND THE APPLICABLE LAW, THE LATTER PREVAILS.

© Hangzhou Hikvision Digital Technology Co., Ltd. All rights reserved.

Preface

Applicable Models

This manual is applicable to the DS-69XXUDI (C) series UHD decoders, including DS-6901UDI(C), DS-6904UDI(C), DS-6908UDI(C), DS-6910UDI(C), DS-6912UDI(C), and DS-6916UDI(C).

Default Parameters



| Type | Default Parameter |
|----------------|--|
| Device | <ul style="list-style-type: none"> • Login user name: admin |
| SSH connection | <ul style="list-style-type: none"> • IP address: 192.0.0.64 |



To improve system security, it is highly recommended to change password regularly. In order to protect your privacy and corporate data and avoid network security issues, it is recommended to set strong password that meets security requirements.

Symbol Conventions

The symbols that may be found in this document are defined as follows.

| Symbol | Description |
|--|---|
|  Note | Provides additional information to emphasize or supplement important points of the main text. |
|  Caution | Indicates a potentially hazardous situation, which if not avoided, could result in equipment damage, data loss, performance degradation, or unexpected results. |
|  Danger | Indicates a hazard with a high level of risk, which if not avoided, will result in death or serious injury. |

Safety Instructions

Caution

- The device must be connected to an earthed mains socket-outlet.
- The socket-outlet shall be installed near the device and shall be easily accessible.
- Do not touch the bare components (such as the metal contacts of the inlets) and wait for at least 5 minutes, since electricity may still exist after the device is powered off.
- Never place the device in an unstable location. The device may fall, causing serious personal injury or death.
- This device is not suitable for use in locations where children are likely to be present.



- **CAUTION:** Risk of explosion if the battery is replaced by an incorrect type.
- Improper replacement of the battery with an incorrect type may defeat a safeguard (for example, in the case of some lithium battery types).
- Do not dispose of the battery into fire or a hot oven, or mechanically crush or cut the battery, which may result in an explosion.
- Do not leave the battery in an extremely high temperature surrounding environment, which may result in an explosion or the leakage of flammable liquid or gas.
- Do not subject the battery to extremely low air pressure, which may result in an explosion or the leakage of flammable liquid or gas.
- Dispose of used batteries according to the instructions.
- Keep body parts away from fan blades. Disconnect the power source during servicing.

Note

- This device is suitable for use in equipment room only.
- Make sure that the power has been disconnected before you wire, install, or disassemble the device.
- The device shall not be exposed to water dripping or splashing, and no objects filled with liquids, such as vases, shall be placed on the device.
- No naked flame sources, such as lighted candles, should be placed on the device.
- If smoke, odor, or noise arises from the device, immediately turn off the power, unplug the power cable, and contact the service center.
- Install the device according to the instructions in Quick Start Guide.
- To prevent injury, this device must be securely attached to the installation surface in accordance with the installation instructions.
- The ventilation should not be impeded by covering the ventilation openings with items, such as newspapers, table-cloths, curtains. The openings shall never be blocked by placing the device on a bed, sofa, rug, or other similar surface.

TABLE OF CONTENTS

| | |
|---|-----------|
| Chapter 1 Introduction | 1 |
| 1.1 Overview | 1 |
| 1.2 Appearance..... | 1 |
| 1.2.1 DS-6901UDI (C) | 1 |
| 1.2.2 DS-6904UDI (C) | 3 |
| 1.2.3 DS-6908UDI (C) | 5 |
| 1.2.4 DS-6910UDI (C) | 6 |
| 1.2.5 DS-6912UDI (C) | 8 |
| 1.2.6 DS-6916UDI (C) | 10 |
| 1.2.7 Panel Component Description | 12 |
| Chapter 2 Installation | 15 |
| 2.1 Safety Precautions | 15 |
| 2.2 Open Package and Check Items | 16 |
| 2.3 Install the Device in the Rack | 17 |
| 2.4 Connect the Grounding Cable..... | 18 |
| 2.5 Connect the Audio and Video Cables..... | 19 |
| 2.6 Connect to the Network | 19 |
| 2.7 Connect to the Screen | 20 |
| 2.8 Connect to the Power Source | 20 |
| Chapter 3 Configuration | 22 |

Chapter 1 Introduction

1.1 Overview

The DS-69XXUDI (C) ultra high definition (UHD) decoder (hereinafter referred as the device), is the latest generation decoder designed specifically for high-definition network cameras, making it suitable for various video security system projects. The device offers exceptional video processing capabilities and a seamless video decoding experience.

The device has the following core advantages:

- **Format flexibility:** Supports various video encoding formats including H.265, H.264, MJPEG, Smart264, and Smart265 to meet diverse video source requirements.
- **Resolution handling:** Decodes H.265 or H.264 video streams of up to 32 MP and lower resolution, ensuring real-time processing and output for high-definition video streams.
- **Output compatibility:** Provides HDMI 1.4 and BNC ports for connection to various display devices.
- **Stunning UHD:** Supports 4K UHD decoding output, delivering enhanced image detail and improving the visual quality for both video security and video playback scenarios.

1.2 Appearance

This chapter lists the panel appearances of different models and versions. To view the descriptions of the panel components, see 1.2.7 Panel Component Description.

1.2.1 DS-6901UDI (C)

V3.3.0

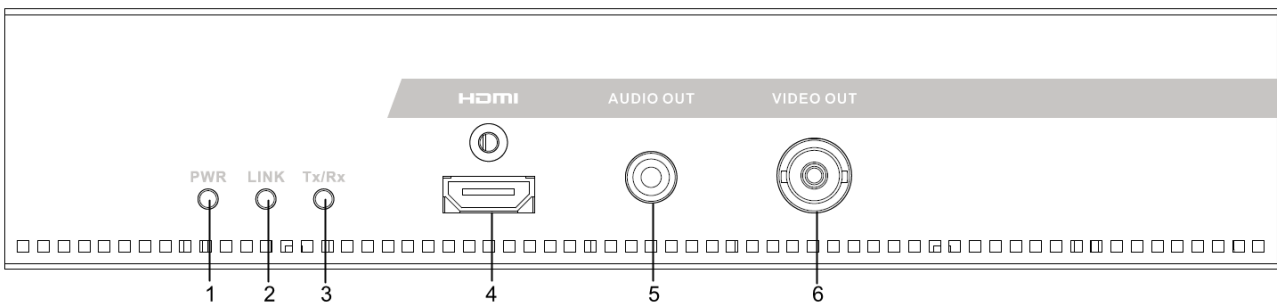

Figure 1-1 DS-6901UDI (C) Front Panel

| | | |
|---------------------|----------------------|----------------------|
| 1. PWR LED | 2. LINK LED | 3. Tx/Rx LED |
| 4. HDMI output port | 5. Audio output port | 6. Video output port |

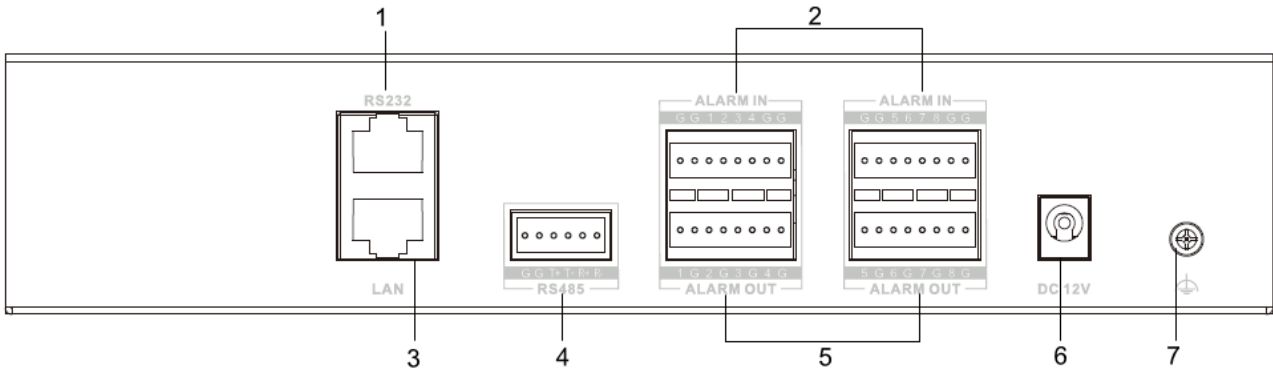

Figure 1-2 DS-6901UDI (C) V3.3.0 Rear Panel

| | | |
|-----------------------|----------------------|------------------------|
| 1. RS-232 port | 2. Alarm input port | 3. LAN port |
| 4. RS-485 port | 5. Alarm output port | 6. Power port (12 VDC) |
| 7. Grounding terminal | | |

V3.1.0

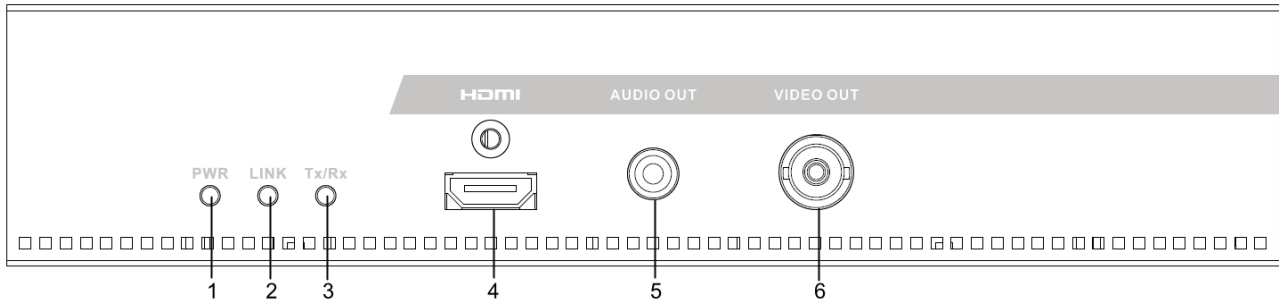

Figure 1-3 DS-6901UDI (C) Front Panel

| | | |
|---------------------|----------------------|----------------------|
| 1. PWR LED | 2. LINK LED | 3. Tx/Rx LED |
| 4. HDMI output port | 5. Audio output port | 6. Video output port |

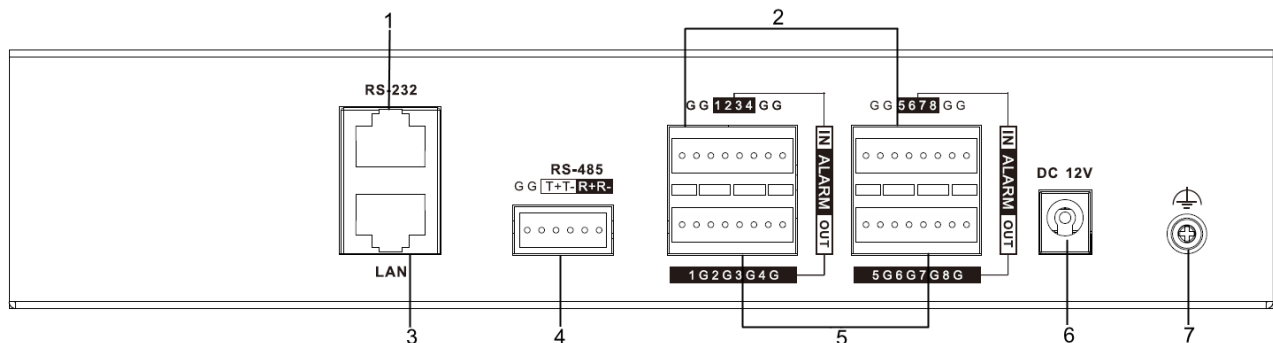

Figure 1-4 DS-6901UDI (C) V3.1.0 Rear Panel

| | | |
|-----------------------|----------------------|------------------------|
| 1. RS-232 port | 2. Alarm input port | 3. LAN port |
| 4. RS-485 port | 5. Alarm output port | 6. Power port (12 VDC) |
| 7. Grounding terminal | | |

1.2.2 DS-6904UDI (C)

V3.3.0

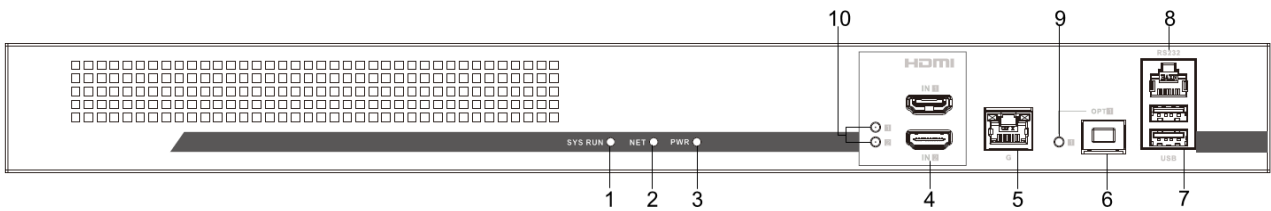

Figure 1-5 DS-6904UDI (C) V3.3.0 Front Panel

| | | |
|--------------------------|------------------------------|----------------------------|
| 1. SYS RUN LED | 2. NET LED | 3. PWR LED |
| 4. HDMI input port | 5. 1000 Mbps electrical port | 6. 1000 Mbps optical port |
| 7. USB 2.0 port | 8. RS-232 port | 9. Optical port status LED |
| 10. HDMI port status LED | | |

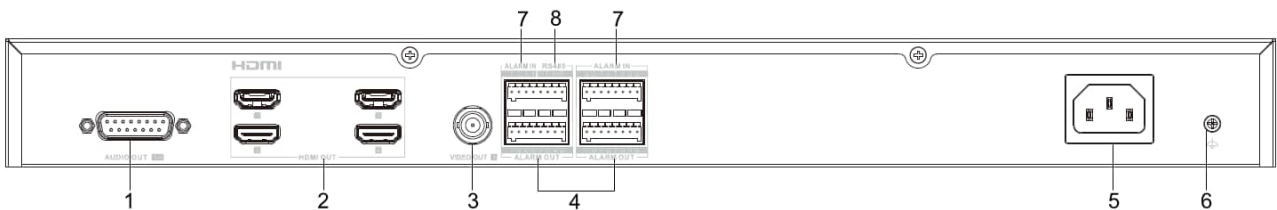

Figure 1-6 DS-6904UDI (C) V3.3.0 Rear Panel

| | | |
|----------------------------------|---------------------|--------------------------|
| 1. DB15 female audio output port | 2. HDMI output port | 3. BNC video output port |
| 4. Alarm output port | 5. Power receptacle | 6. Grounding terminal |
| 7. Alarm input port | 8. RS-485 port | |

V3.0.0

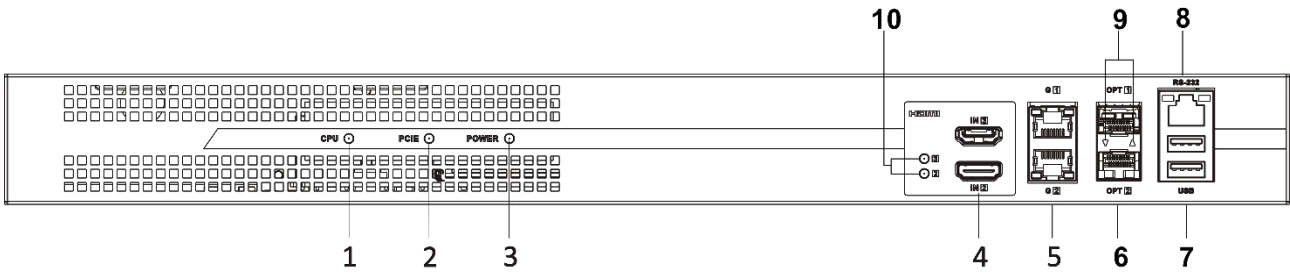

Figure 1-7 DS-6904UDI (C) V3.0.0 Front Panel

| | | |
|--------------------------|------------------------------|----------------------------|
| 1. CPU LED | 2. PCIE LED | 3. POWER LED |
| 4. HDMI input port | 5. 1000 Mbps electrical port | 6. 1000 Mbps optical port |
| 7. USB 2.0 port | 8. RS-232 port | 9. Optical port status LED |
| 10. HDMI port status LED | | |

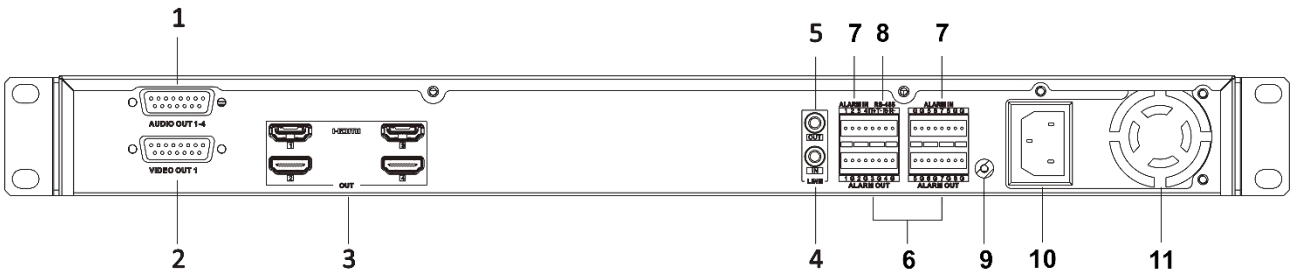

Figure 1-8 DS-6904UDI (C) V3.0.0 Rear Panel

| | | |
|----------------------------------|----------------------------------|-----------------------|
| 1. DB15 female audio output port | 2. DB15 female video output port | 3. HDMI output port |
| 4. 3.5 mm audio input jack | 5. 3.5 mm audio output jack | 6. Alarm output port |
| 7. Alarm input port | 8. RS-485 port | 9. Grounding terminal |
| 10. Power receptacle | 11. Fan of power module | |

1.2.3 DS-6908UDI (C)

V3.3.0

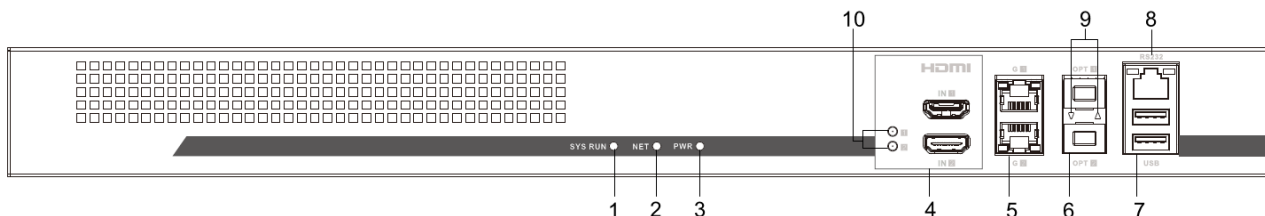

Figure 1-9 DS-6908UDI (C) V3.3.0 Front Panel

| | | |
|--------------------------|------------------------------|----------------------------|
| 1. SYS RUN LED | 2. NET LED | 3. PWR LED |
| 4. HDMI input port | 5. 1000 Mbps electrical port | 6. 1000 Mbps optical port |
| 7. USB 2.0 port | 8. RS-232 port | 9. Optical port status LED |
| 10. HDMI port status LED | | |

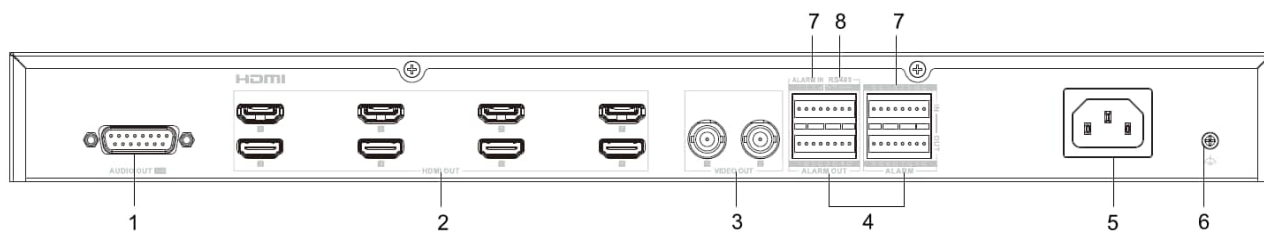

Figure 1-10 DS-6908UDI (C) V3.3.0 Rear Panel

| | | |
|----------------------------------|---------------------|--------------------------|
| 1. DB15 female audio output port | 2. HDMI output port | 3. BNC video output port |
| 4. Alarm output port | 5. Power receptacle | 6. Grounding terminal |
| 7. Alarm input port | 8. RS-485 port | |

V3.0.0

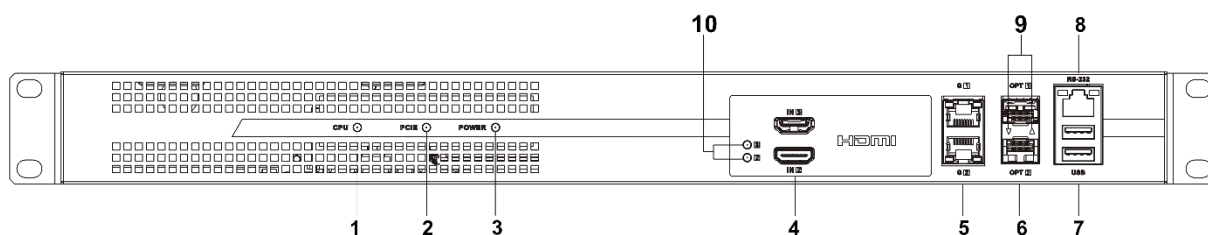

Figure 1-11 DS-6908UDI (C) V3.0.0 Front Panel

| | | |
|--------------------------|------------------------------|----------------------------|
| 1. CPU LED | 2. PCIE LED | 3. POWER LED |
| 4. HDMI input port | 5. 1000 Mbps electrical port | 6. 1000 Mbps optical port |
| 7. USB 2.0 port | 8. RS-232 port | 9. Optical port status LED |
| 10. HDMI port status LED | | |

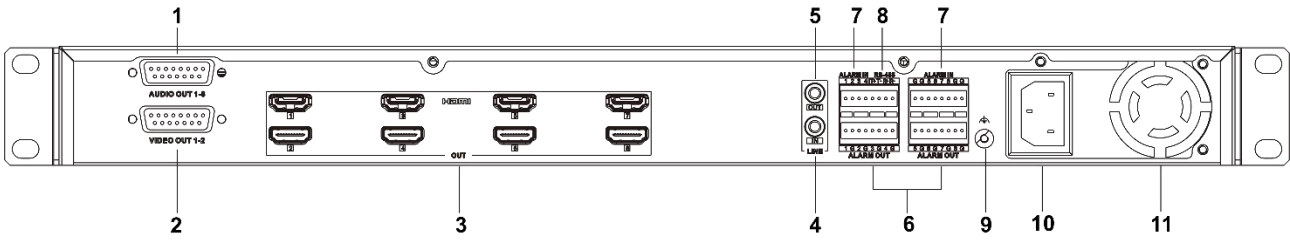

Figure 1-12 DS-6908UDI (C) V3.0.0 Rear Panel

| | | |
|----------------------------------|----------------------------------|-----------------------|
| 1. DB15 female audio output port | 2. DB15 female video output port | 3. HDMI output port |
| 4. 3.5 mm audio input jack | 5. 3.5 mm audio output jack | 6. Alarm output port |
| 7. Alarm input port | 8. RS-485 port | 9. Grounding terminal |
| 10. Power receptacle | 11. Fan of power module | |

1.2.4 DS-6910UDI (C)

V3.3.0

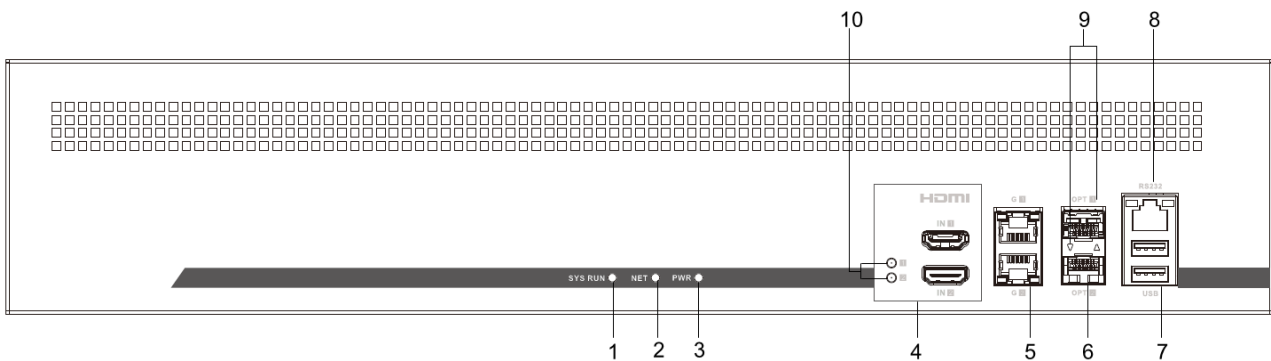

Figure 1-13 DS-6910UDI (C) V3.3.0 Front Panel

| | | |
|--------------------------|------------------------------|----------------------------|
| 1. SYS RUN LED | 2. NET LED | 3. PWR LED |
| 4. HDMI input port | 5. 1000 Mbps electrical port | 6. 1000 Mbps optical port |
| 7. USB 2.0 port | 8. RS-232 port | 9. Optical port status LED |
| 10. HDMI port status LED | | |

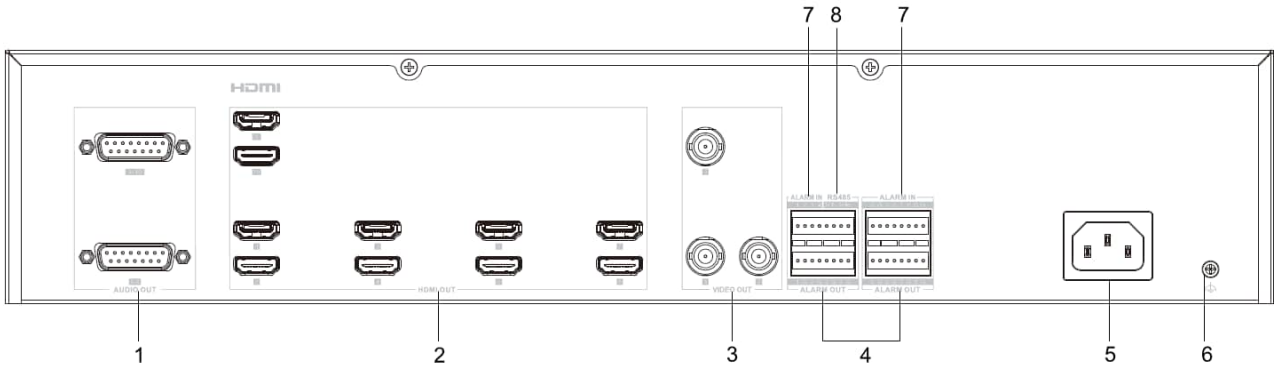

Figure 1-14 DS-6910UDI (C) V3.3.0 Rear Panel

| | | |
|----------------------------------|---------------------|--------------------------|
| 1. DB15 female audio output port | 2. HDMI output port | 3. BNC video output port |
| 4. Alarm output port | 5. Power receptacle | 6. Grounding terminal |
| 7. Alarm input port | 8. RS-485 port | |

V3.0.0

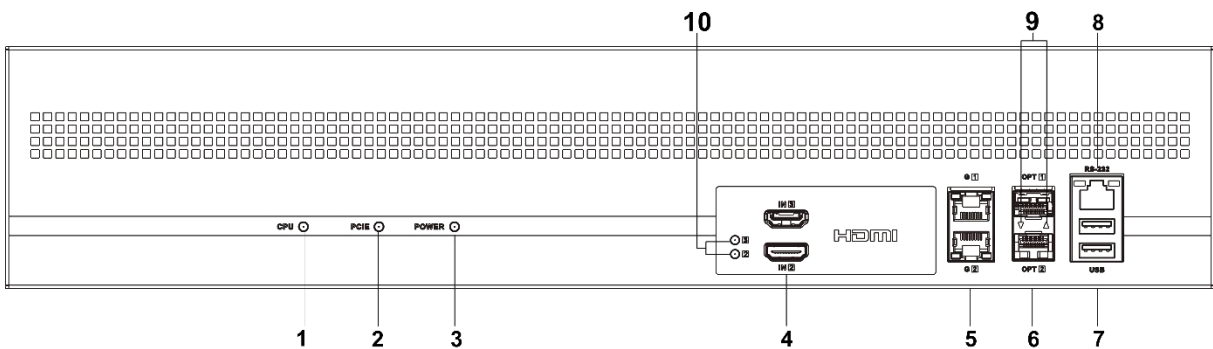

Figure 1-15 DS-6910UDI (C) V3.0.0 Front Panel

| | | |
|--------------------|------------------------------|----------------------------|
| 1. CPU LED | 2. PCIE LED | 3. POWER LED |
| 4. HDMI input port | 5. 1000 Mbps electrical port | 6. 1000 Mbps optical port |
| 7. USB 2.0 port | 8. RS-232 port | 9. Optical port status LED |

| | | |
|--------------------------|--|--|
| 10. HDMI port status LED | | |
|--------------------------|--|--|

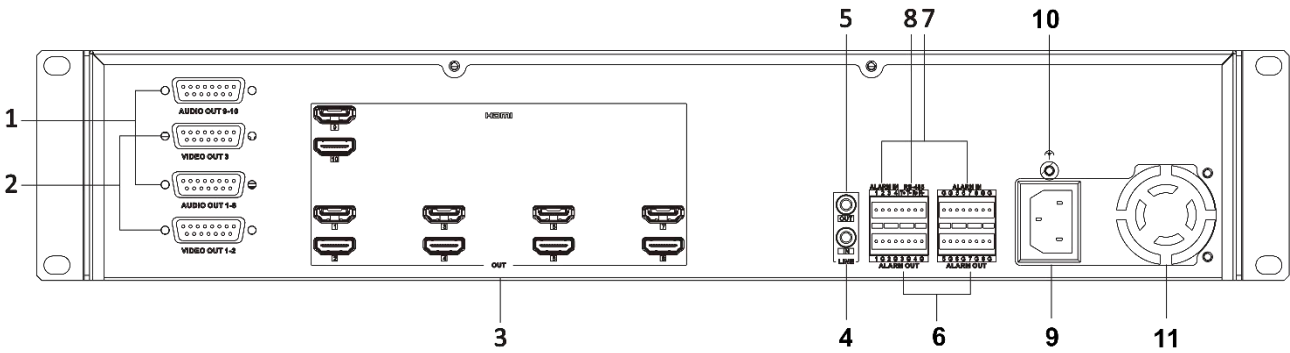

Figure 1-16 DS-6910UDI (C) V3.0.0 Rear Panel

| | | |
|----------------------------------|----------------------------------|----------------------|
| 1. DB15 female audio output port | 2. DB15 female video output port | 3. HDMI output port |
| 4. 3.5 mm audio input jack | 5. 3.5 mm audio output jack | 6. Alarm output port |
| 7. Alarm input port | 8. RS-485 port | 9. Power receptacle |
| 10. Grounding terminal | 11. Fan of power module | |

1.2.5 DS-6912UDI (C)

V3.3.0

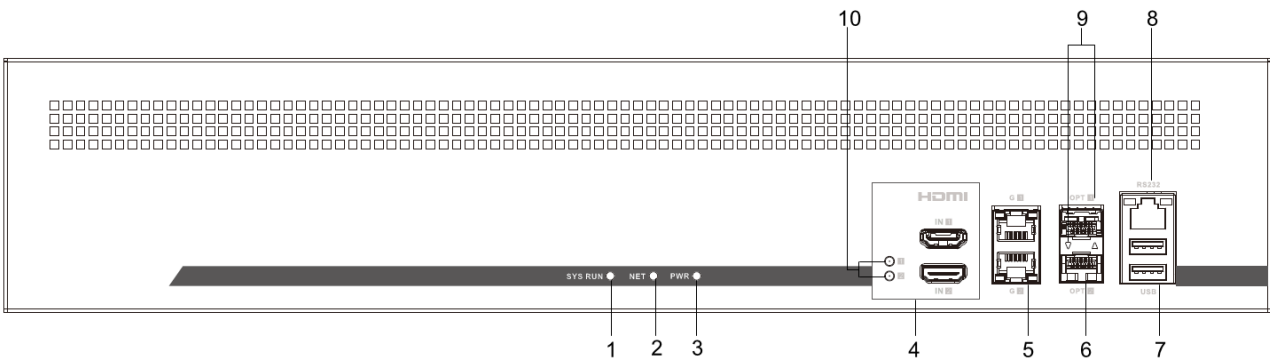

Figure 1-17 DS-6912UDI (C) V3.3.0 Front Panel

| | | |
|--------------------------|------------------------------|----------------------------|
| 1. SYS RUN LED | 2. NET LED | 3. PWR LED |
| 4. HDMI input port | 5. 1000 Mbps electrical port | 6. 1000 Mbps optical port |
| 7. USB 2.0 port | 8. RS-232 port | 9. Optical port status LED |
| 10. HDMI port status LED | | |

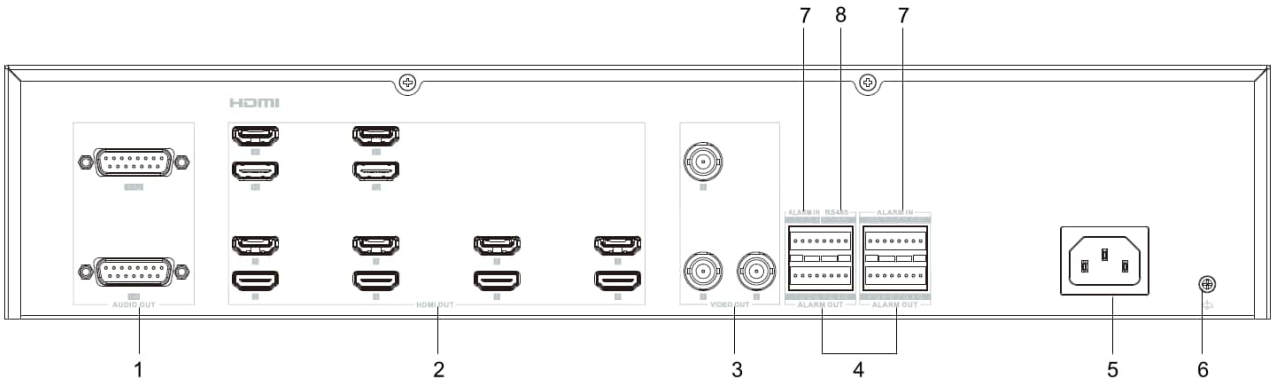

Figure 1-18 DS-6912UDI (C) V3.3.0 Rear Panel

| | | |
|----------------------------------|---------------------|--------------------------|
| 1. DB15 female audio output port | 2. HDMI output port | 3. BNC video output port |
| 4. Alarm output port | 5. Power receptacle | 6. Grounding terminal |
| 7. Alarm input port | 8. RS-485 port | |

V3.0.0

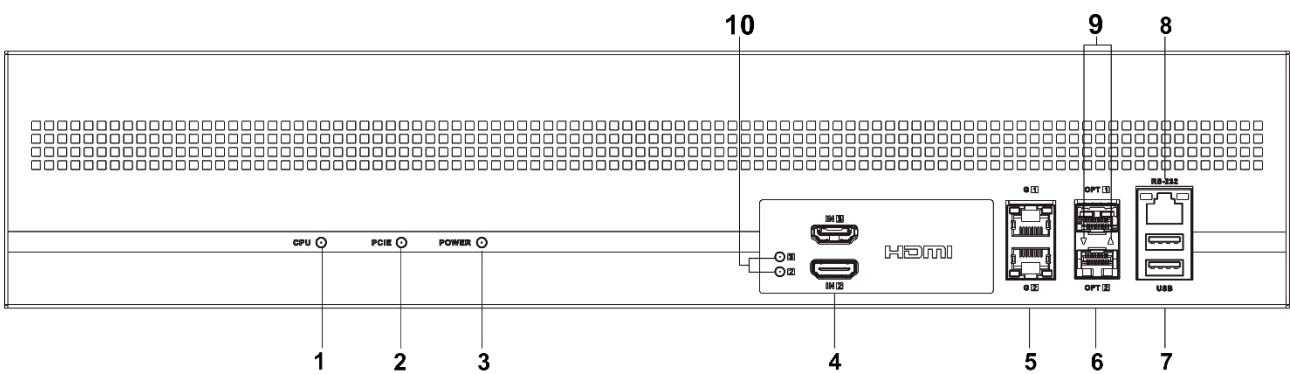

Figure 1-19 DS-6912UDI (C) V3.0.0 Front Panel

| | | |
|--------------------|------------------------------|----------------------------|
| 1. CPU LED | 2. PCIE LED | 3. POWER LED |
| 4. HDMI input port | 5. 1000 Mbps electrical port | 6. 1000 Mbps optical port |
| 7. USB 2.0 port | 8. RS-232 port | 9. Optical port status LED |

| | | |
|--------------------------|--|--|
| 10. HDMI port status LED | | |
|--------------------------|--|--|

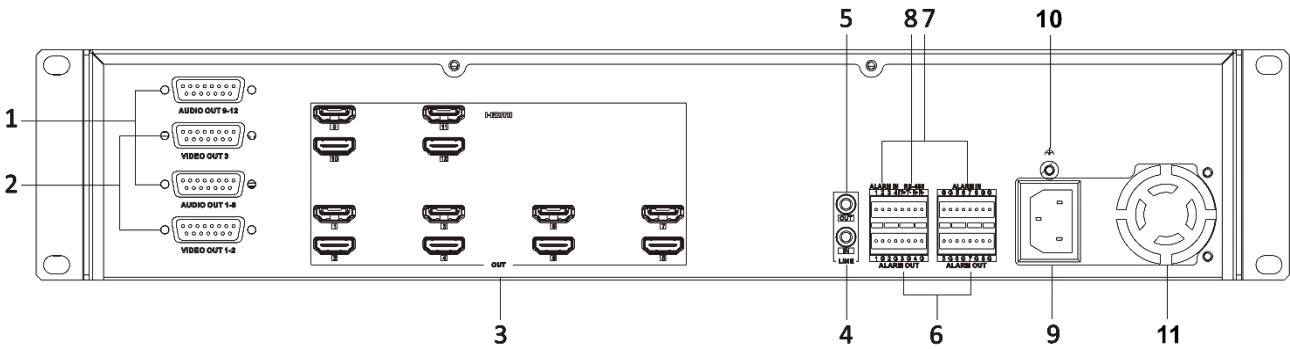

Figure 1-20 DS-6912UDI (C) V3.0.0 Rear Panel

| | | |
|----------------------------------|----------------------------------|----------------------|
| 1. DB15 female audio output port | 2. DB15 female video output port | 3. HDMI output port |
| 4. 3.5 mm audio input jack | 5. 3.5 mm audio output jack | 6. Alarm output port |
| 7. Alarm input port | 8. RS-485 port | 9. Power receptacle |
| 10. Grounding terminal | 11. Fan of power module | |

1.2.6 DS-6916UDI (C)

V3.3.0

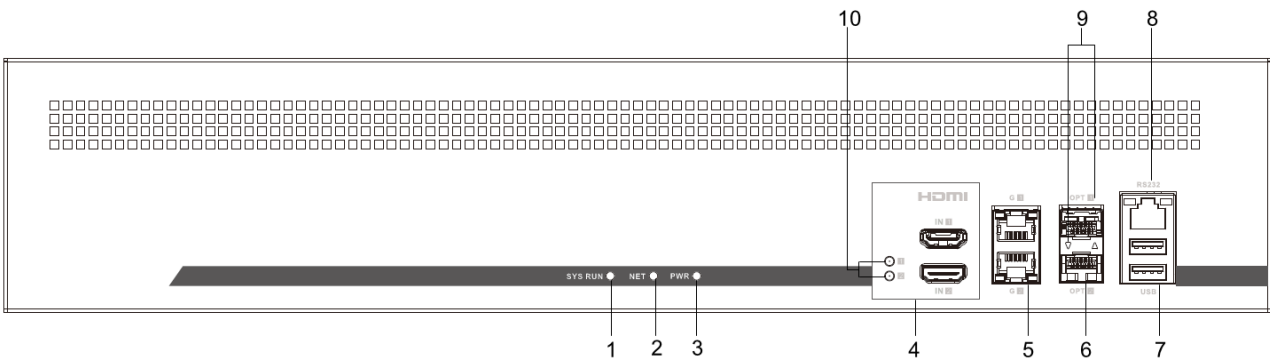

Figure 1-21 DS-6916UDI (C) V3.3.0 Front Panel

| | | |
|--------------------------|------------------------------|----------------------------|
| 1. SYS RUN LED | 2. NET LED | 3. PWR LED |
| 4. HDMI input port | 5. 1000 Mbps electrical port | 6. 1000 Mbps optical port |
| 7. USB 2.0 port | 8. RS-232 port | 9. Optical port status LED |
| 10. HDMI port status LED | | |

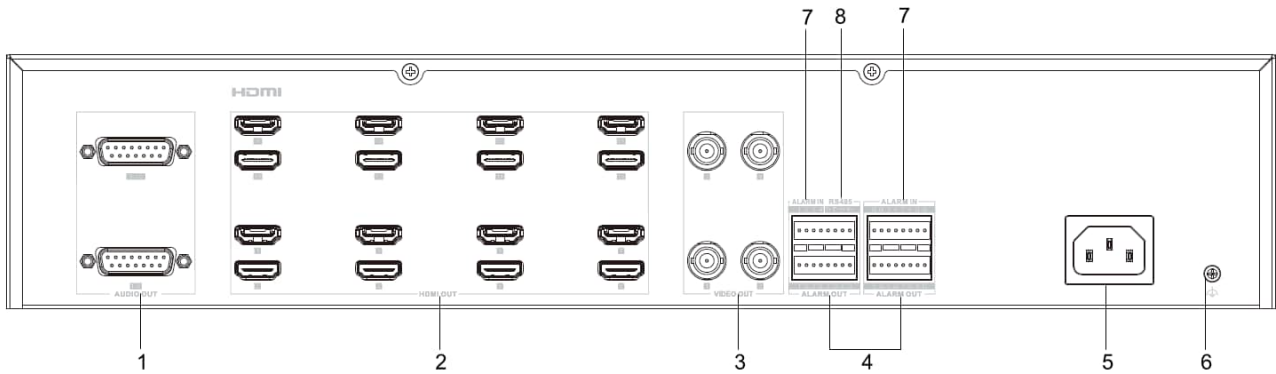

Figure 1-22 DS-6916UDI (C) V3.3.0 Rear Panel

| | | |
|----------------------------------|---------------------|--------------------------|
| 1. DB15 female audio output port | 2. HDMI output port | 3. BNC video output port |
| 4. Alarm output port | 5. Power receptacle | 6. Grounding terminal |
| 7. Alarm input port | 8. RS-485 port | |

V3.0.0

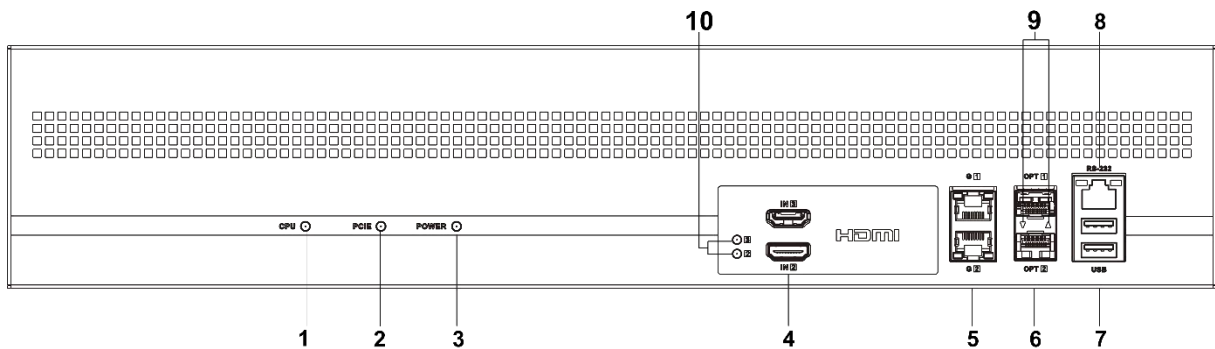

Figure 1-23 DS-6916UDI (C) V3.0.0 Front Panel

| | | |
|--------------------|------------------------------|----------------------------|
| 1. CPU LED | 2. PCIE LED | 3. POWER LED |
| 4. HDMI input port | 5. 1000 Mbps electrical port | 6. 1000 Mbps optical port |
| 7. USB 2.0 port | 8. RS-232 port | 9. Optical port status LED |

| | | |
|--------------------------|--|--|
| 10. HDMI port status LED | | |
|--------------------------|--|--|

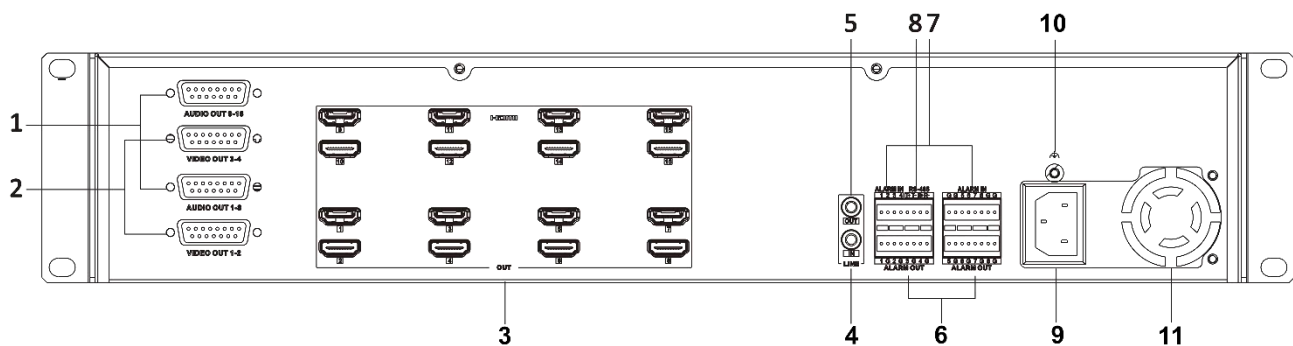

Figure 1-24 DS-6916UDI (C) V3.0.0 Rear Panel

| | | |
|----------------------------------|----------------------------------|----------------------|
| 1. DB15 female audio output port | 2. DB15 female video output port | 3. HDMI output port |
| 4. 3.5 mm audio input jack | 5. 3.5 mm audio output jack | 6. Alarm output port |
| 7. Alarm input port | 8. RS-485 port | 9. Power receptacle |
| 10. Grounding terminal | 11. Fan of power module | |

1.2.7 Panel Component Description

Front Panel

Table 1-1 Description of Front Panel Components

| Component Type | Name | Description |
|----------------|---------------|---|
| Indicator | PWR/POWER LED | On: the device is powered on. <ul style="list-style-type: none"> ● V3.3.0: steady green. ● V3.2.0/V3.0.0: steady red. |
| | LINK LED | <ul style="list-style-type: none"> ● On: The network cable is connected. ● Flashing green: the device external network runs normally. |
| | Tx/Rx LED | Flashing green: the device transmits data normally. |
| | CPU LED | Steady green: the subsystem communication is normal. |
| | PCIE LED | Steady green: the internal network communication of the device is normal. |

| | | |
|------|---------------------------|---|
| | SYS RUN LED | Steady green: the subsystem communication is normal. |
| | NET LED | Steady green: the internal network communication of the device is normal. |
| | Optical port status LED | Flashing green: the optical port communication is normal. |
| | HDMI port status LED | Steady green: the HDMI input is normal. |
| Port | HDMI input port | Connects to the video source. |
| | 1000 Mbps electrical port | Connects to a network cable to allow the device to obtain the network stream. |
| | 1000 Mbps optical port | Connects to a fiber optic cable to allow the device to obtain the network stream. |
| | USB 2.0 port | Connects to the USB flash drive for device debugging. |
| | RS-232 port | Connects to the serial cable for device debugging. |
| | Audio output port | Connects to the audio playback device with the amplifier. |
| | Video output port | Connects to the BNC cable for video output. |

Rear Panel

Table 1-2 Description of Rear Panel Components

| Name | Description |
|-------------------------------|---|
| DB15 female audio output port | Connects to a DB15-to-BNC cable for audio output. |
| DB15 female video output port | Connects to a DB15-to-BNC cable for video output. |
| HDMI output port | Connects to a monitor. |
| BNC video output port | Connects to the BNC cable for video output. |
| 3.5 mm audio input jack | Connects to the audio input source. |
| 3.5 mm audio output jack | Connects to the audio playback device with the amplifier. |
| Alarm output port | Connects to the switching alarm device. |
| Alarm input port | Connects to the switching output device. |
| RS-232 port | Connects to the serial cable for device debugging. |
| RS-485 port | Connects to the RS-485 port of an external device. |
| LAN port | Connects to the network cable to allow the device to obtain the network stream. |
| Power port (12 VDC) | Connects to the DC power cord. |
| Power receptacle | Connects to the AC power cord. |
| Fan of power module | The embedded fan cools down the power module. |
| Grounding terminal | Connects to the grounding cable. |

Chapter 2 Installation

2.1 Safety Precautions



As a high-precision, system-level electronic product, the device should be installed and maintained by professionals.

In order to avoid personal and property injury, please read the safety precautions in this section carefully before installation. The following safety recommendations do not cover all possible dangerous situations.

Electricity Safety

- During the installation, wiring, disassembly, and maintenance of the device, please disconnect the power supply and do not operate with electricity (except for the operation of the hot plug).
- In the installation and use of the device, make sure to follow the local electrical safety regulations.
- In case of abnormal phenomena such as smoke or odor occur during the use of the device, please cut off the power immediately, unplug the power cord from the socket, and contact the after-sales service center in time.

Anti-Static Measures

The equipment is a precision electronic device. In order to avoid static electricity from damaging the components, in addition to anti-static measures in the equipment room, you must wear anti-static gloves or anti-static wrists during the installation process.

Grounding Requirements

In order to ensure personal safety and device safety, the device must be grounded.

Power Supply Requirements

- The DS-6901UDI (C) supports 12 VDC power supply and other devices support 100 VAC to 240 VAC@50/60 Hz power supply. To ensure the stable operation of the device, it is recommended to install UPS for power supply.
- Input voltage should meet the SELV (Safety Extra Low Voltage) and the LPS (Limited Power Source) according to the IEC62368.

Anti-Interference Requirements

- The on-site power supply system must have effective measures to prevent grid interference.
- Do not use the working ground together with the grounding device or lightning protection grounding device of power equipment, and keep the two as far away as possible.
- Keep away from high-power radio transmitters, radar transmitters, and high-frequency and high-current equipment.
- When necessary, electromagnetic shielding can be used for anti-interference.

Environmental Requirements

The device is a system-level monitoring equipment, which is generally placed in the central equipment room of the monitoring system at all levels. The selection of the installation site should comply with the relevant standards of the equipment room construction in the country and region of use.

The device is a standard rack-mounted equipment. Please pay attention to the following information during installation and use:

- Ensure that the temperature in the rack is from -10 °C to 50 °C.
- Ensure that the humidity in the equipment room is between 0% and 90% RH.
- Ensure that the rack is strong enough to support the weight of the device and its accessories. During the installation, avoid the risk caused by uneven mechanical load.
- Ensure that there is enough installation space for the video and audio cables. The bending radius of a cable should not be less than 5 times the cable outer diameter.
- Keep the horizontal distance between the decoder and other devices above 50 cm for sufficient ventilation.

2.2 Open Package and Check Items

Open the device package to verify that all items in the package are intact according to the packing list.

Table 2-1 Packing List

| Device Model | Items | Quantity |
|-----------------------------------|---|----------|
| DS-6901UDI (C) | Device | 1 |
| | Power adapter | 1 |
| | Grounding cable | 1 |
| | Regulatory compliance and safety information manual | 1 |
| DS-6904UDI (C)/ DS-6908UDI (C) | Device | 1 |
| | AC power cord | 1 |

| Device Model | Items | Quantity |
|--|---|----------|
| DS-6910UDI (C)/ DS-6912UDI (C)/ DS-6916UDI (C) | Grounding cable | 1 |
| | Regulatory compliance and safety information manual | 1 |
| | Mounting brackets | 1 pair |
| | Pads | 4 |

Note

- V3.3.0: By default, the DB15M to BNC audio adapter cable is not shipped with the device. If needed, order it.
- V3.2.0/V3.0.0: By default, the DB15M to BNC audio adapter cable is shipped with the device.

2.3 Install the Device in the Rack

The rack mounting methods are the same for all DS-69XXUDI (C) decoders.

Note

Prepare the rack by yourself.

Step 1 Use the provided M3 × 6 screws (1) to install the mounting brackets (2) to two sides of the front panel of the device (3).

Step 2 Select an empty slot on the rack (4) and then use the M6 screws (5) shipped with the rack to secure the device installed with the mounting brackets to the fixing grooves on both sides of the rack.

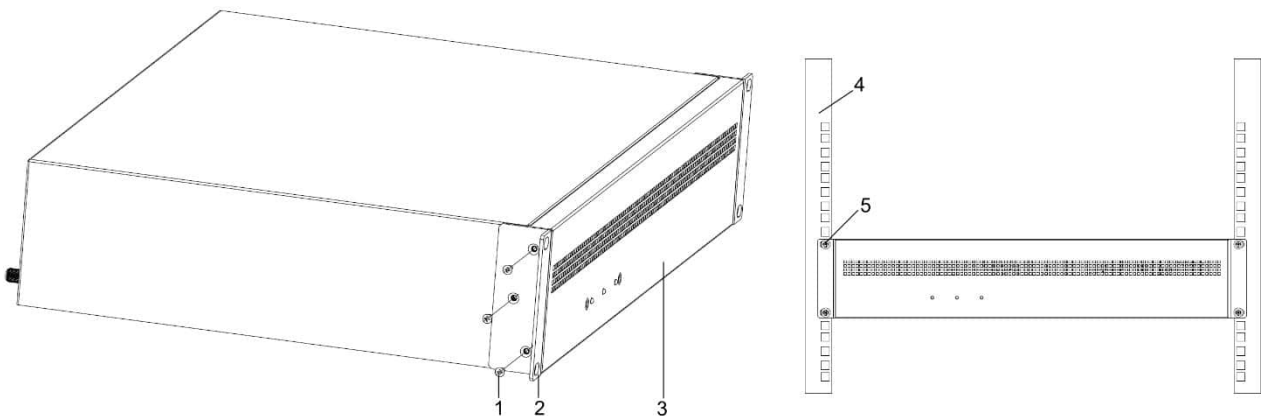

Figure 2-1 Install the Device in the Rack

2.4 Connect the Grounding Cable

Connecting the grounding cable can release the excessive voltage and current induced by lightning shock. Please select the most suitable connection mode to protect the grounding cable according to the installation environment.

Use Grounding Bar

Step 1 Connect one end of the grounding cable (2) to the grounding terminal of the grounding bar (3) in the equipment room.

Step 2 Connect the other end of the grounding cable to the grounding terminal (1) of the device and tighten the screw.

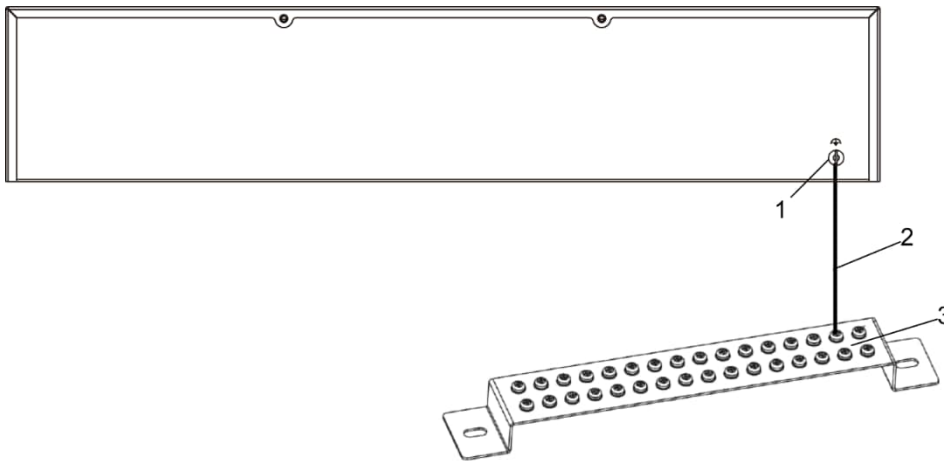

Figure 2-2 Connect the Grounding Cable to the Grounding Bar

Use Grounding Electrode

Step 1 Drive a grounding electrode (4) into the ground (3) of at least 0.5 m.

Step 2 Weld one end of the grounding cable (2) to the grounding electrode and treat the welding points with corrosion protection (electroplate or coating).

Step 3 Connect the other end of the grounding cable to the grounding terminal (1) of the device.

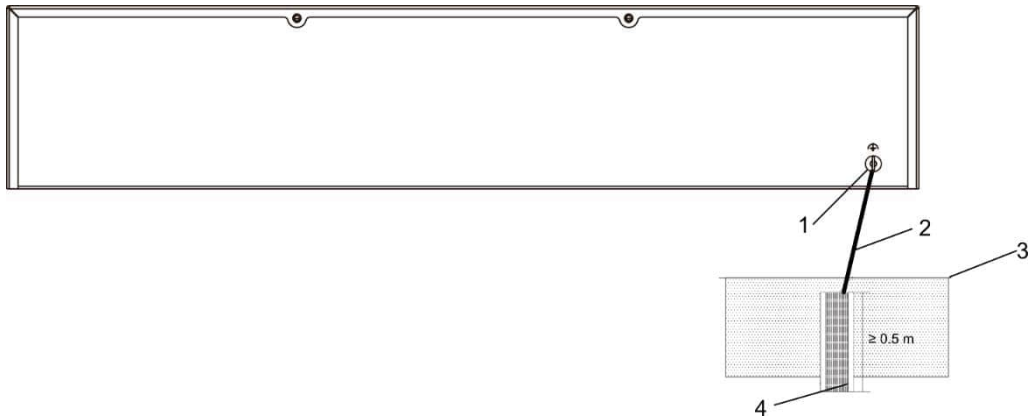

Figure 2-3 Connect the Grounding Cable to the Grounding Electrode

2.5 Connect the Audio and Video Cables

According to the port type, select the appropriate audio and video cables and connect the cables to the device.

Table 2-2 Audio and Video Cables

| Port Type | Video Cable | Audio Cable |
|-------------------------------|--|---|
| HDMI input and output ports | HDMI cable (user supplied) | HDMI cable (user supplied) |
| BNC video output port | BNC cable (user supplied) | / |
| DB15 female video output port | DB15M to BNC video adapter cable (user supplied) | / |
| DB15 female audio output port | / | DB15M to BNC audio adapter cable (It is provided as ordered or user supplied in V3.3.0 and is provided with the device in V3.2.0/V3.0.0.) |
| 3.5 mm audio input jack | / | 3.5 mm audio cable (user supplied) |
| 3.5 mm audio output jack | / | 3.5 mm audio cable (user supplied) |

2.6 Connect to the Network

The device is connected to the network through networking equipment such as switches. It is recommended to use the CAT 6 Ethernet cable to connect the network port of the device to the network port of the networking equipment.

2.7 Connect to the Screen

- Connect an LCD screen and the device: Use a video cable to connect a video output port of the device to a video input port of the LCD screen.
- Connect an LED screen and the device: One LED screen consists of multiple LED cabinets. Use multiple network cables to connect multiple LED cabinets to one LED controller, and then use a video cable to connect a video output port of the device to a video input port of the LED controller.

Note

The figure below is for illustration only.

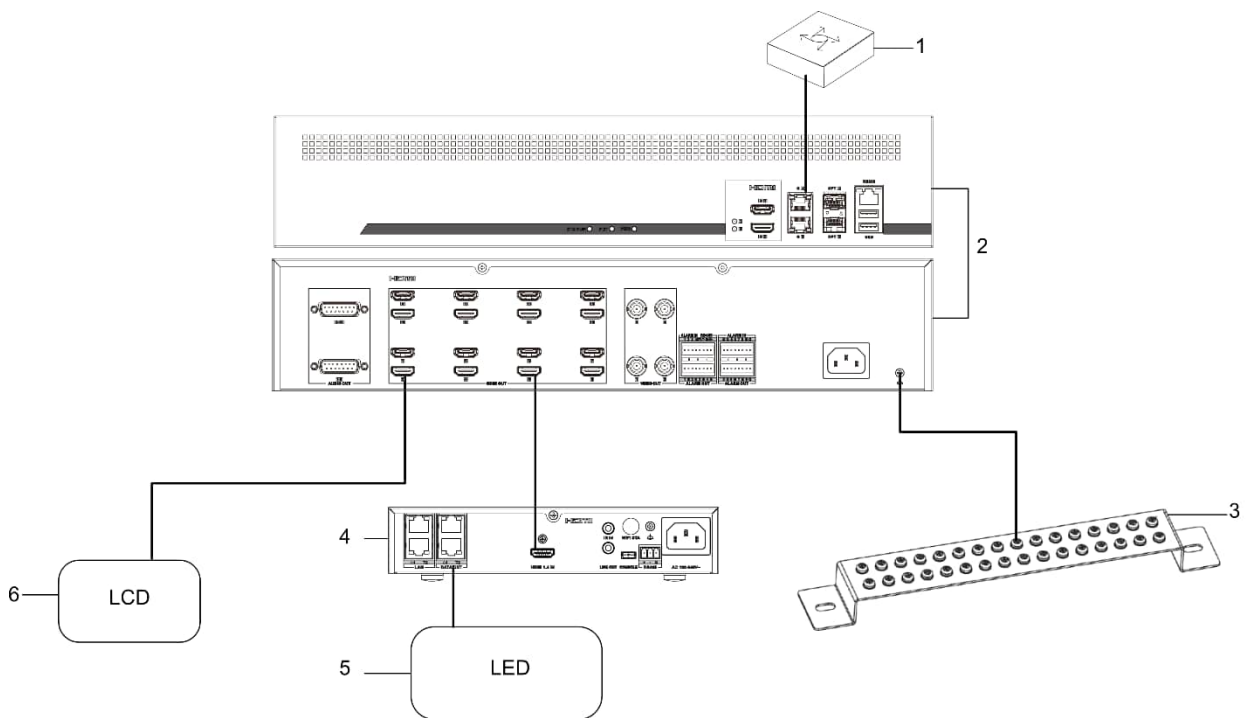

Figure 2-4 Device Connection Schematic Diagram

| | | |
|-------------------|---------------|------------------|
| 1. Switch | 2. Device | 3. Grounding bar |
| 4. LED controller | 5. LED screen | 6. LCD screen |

2.8 Connect to the Power Source

Select an appropriate power cord to connect the device to the power supply in the equipment room. After the power cable is connected, the device is powered on.

- Use a DC power cord to connect the power port of the DS-6901UDI (C).

- Use an AC power cord to connect the power receptacle of the DS-6904UDI (C), DS-6908UDI (C), DS-6910UDI (C), DS-6912UDI (C), or DS-6916UDI (C).

Chapter 3 Configuration

Scan the QR code below to view the [user manual](#) to configure the device.



Obtaining the manual requires network data traffic. It is recommended to be performed in a Wi-Fi environment.



Figure 3-1 User Manual



See Far, Go Further