



Network Camera

Quick Guide

DC-T4516WRX

DC-T4516WRX-A



Powered by **Direct IP**®

Safety Precautions

WARNING

RISK OF ELECTRIC SHOCK
DO NOT OPEN

WARNING: TO REDUCE THE RISK OF ELECTRIC SHOCK,
DO NOT REMOVE COVER (OR BACK). NO USER-SERVICEABLE PARTS INSIDE.
REFER SERVICING TO QUALIFIED SERVICE PERSONNEL.

Important Safeguards

1. Read Instructions

All the safety and operating instructions should be read before the appliance is operated.

2. Retain Instructions

The safety and operating instructions should be retained for future reference.

3. Cleaning

Unplug this equipment from the wall outlet before cleaning it. Do not use liquid aerosol cleaners. Use a damp soft cloth for cleaning.

4. Attachments

Never add any attachments and/or equipment without the approval of the manufacturer as such additions may result in the risk of fire, electric shock or other personal injury.

5. Water and/or Moisture

Do not use this equipment near water or in contact with water.

6. Placing and Accessories

Do not place this equipment on a wall or ceiling that is not strong enough to sustain the camera. The equipment may fall, causing serious injury to a child or adult, and serious damage to the equipment. Wall or shelf mounting should follow the manufacturer's instructions, and should use a mounting kit approved by the manufacturer.

This equipment and cart combination should be moved with care. Quick stops, excessive force, and uneven surfaces may cause the equipment and cart combination to overturn.

Do not place this equipment in an enclosed space. Sufficient ventilation is required to prevent an increase in ambient temperature which can cause malfunction or the risk of fire.

7. Power Sources

This equipment should be operated only from the type of power source indicated on the marking label. If you are not sure of the type of power, please consult your equipment dealer or local power company.

You may want to install a UPS (Uninterruptible Power Supply) system for safe operation in order to prevent damage caused by an unexpected power stoppage. Any questions concerning UPS, consult your UPS retailer.

8. Power Cord

Operator or installer must remove power and TNT connections before handling the equipment.

9. Lightning

For added protection for this equipment during a lightning storm, or when it is left unattended and unused for long periods of time, unplug it from the wall outlet and disconnect the antenna or cable system. This will prevent damage to the equipment due to lightning and power-line surges. If thunder or lightning is common where the equipment is installed, use a surge protection device.



10. Overloading

Do not overload wall outlets and extension cords as this can result in the risk of fire or electric shock.

11. Objects and Liquids

Never push objects of any kind through openings of this equipment as they may touch dangerous voltage points or short out parts that could result in a fire or electric shock. Never spill liquid of any kind on the equipment.

12. Servicing

Do not attempt to service this equipment yourself. Refer all servicing to qualified service personnel.

13. Damage requiring Service

Unplug this equipment from the wall outlet and refer servicing to qualified service personnel under the following conditions:

- When the power-supply cord or the plug has been damaged.
- If liquid is spilled, or objects have hit the equipment.
- If the equipment has been exposed to rain or water.
- If the equipment does not operate normally by following the operating instructions, adjust only those controls that are covered by the operating instructions as an improper adjustment of other controls may result in damage and will often require extensive work by a qualified technician to restore the equipment to its normal operation.
- If the equipment has been dropped, or the cabinet damaged.
- When the equipment exhibits a distinct change in performance — this indicates a need for service.

14. Replacement Parts

When replacement parts are required, be sure the service technician has used replacement parts specified by the manufacturer or that have the same characteristics as the original part. Unauthorized substitutions may result in fire, electric shock or other hazards.

15. Safety Check

Upon completion of any service or repairs to this equipment, ask the service technician to perform safety checks to determine that the equipment is in proper operating condition.

16. Field Installation

This installation should be made by a qualified service person and should conform to all local codes.

17. Tmra

A manufacturer's maximum recommended ambient temperature (Tmra) for the equipment must be specified so that the customer and installer may determine a suitable maximum operating environment for the equipment.

FCC Compliance Statement

THIS EQUIPMENT HAS BEEN TESTED AND FOUND TO COMPLY WITH THE LIMITS FOR A CLASS A DIGITAL DEVICE, PURSUANT TO PART 15 OF THE FCC RULES. THESE LIMITS ARE DESIGNED TO PROVIDE REASONABLE PROTECTION AGAINST HARMFUL INTERFERENCE WHEN THE EQUIPMENT IS OPERATED IN A COMMERCIAL ENVIRONMENT. THIS EQUIPMENT GENERATES, USES, AND CAN RADIATE RADIO FREQUENCY ENERGY AND IF NOT INSTALLED AND USED IN ACCORDANCE WITH THE INSTRUCTION MANUAL, MAY CAUSE HARMFUL INTERFERENCE TO RADIO COMMUNICATIONS. OPERATION OF THIS EQUIPMENT IN A RESIDENTIAL AREA IS LIKELY TO CAUSE HARMFUL INTERFERENCE, IN WHICH CASE USERS WILL BE REQUIRED TO CORRECT THE INTERFERENCE AT THEIR OWN EXPENSE.

WARNING: CHANGES OR MODIFICATIONS NOT EXPRESSLY APPROVED BY THE PARTY RESPONSIBLE FOR COMPLIANCE COULD VOID THE USER'S AUTHORITY TO OPERATE THE EQUIPMENT. THIS CLASS OF DIGITAL APPARATUS MEETS ALL REQUIREMENTS OF THE CANADIAN INTERFERENCE CAUSING EQUIPMENT REGULATIONS.

WEEE (Waste Electrical & Electronic Equipment)

Correct Disposal of This Product

(Applicable in the European Union and other European countries with separate collection systems)



This marking shown on the product or its literature, indicates that it should not be disposed with other household wastes at the end of its working life. To prevent possible harm to the environment or human health from uncontrolled waste disposal, please separate this from other types of wastes and recycle it responsibly to promote the sustainable reuse of material resources.

Household users should contact either the retailer where they purchased this product, or their local government office, for details of where and how they can take this item for environmentally safe recycling.

Business users should contact their supplier and check the terms and conditions of the purchase contract. This product should not be mixed with other commercial wastes for disposal.

Copyright

© 2021 IDIS Co., Ltd.

IDIS Co., Ltd. reserves all rights concerning this document.

Use or duplication of this document in part or whole without the prior consent of IDIS Co., Ltd. is strictly prohibited.

Contents of this document are subject to change without prior notice for reasons such as functionality enhancements.

Registered Trademarks

IDIS is a registered trademark of IDIS Co., Ltd.

Other company and product names are registered trademarks of their respective owners.

The information in this document is believed to be accurate as of the date of publication even though explanation about some functions may not be incorporated. The manufacturer is not responsible for any problems resulting from the use thereof. The information contained herein is subject to change without notice. Revisions or new editions to this publication may be issued to incorporate such changes.

The software included in this product contains some Open Sources. You may obtain the corresponding source code which we have to distribute according to the license policy. For more information, refer to **System > General** page. This product includes software developed by the University of California, Berkeley and its contributors, and software developed by the OpenSSL Project for use in the OpenSSL Toolkit (<http://www.openssl.org/>). Also, this product includes cryptographic software written by Eric Young (ey@cryptsoft.com).

Covered by one or more claims of the patents listed at patentlist.accessadvance.com.

Accessories

Upon purchasing the product, check inside the box to make sure all the following accessories are included. Some parts may differ depending on the situation.

Network Camera	RJ45 moduler jack, RJ45 waterproof rubber ring, RJ45 connector protect cover, cable waterproof rubber ring, RJ45 connector back cover
Screws and Anchors (each 4ea.)	Allen Wrench
Bushings (4ea.)	Quick Guide

Please download software (IDIS Discovery, IDIS Center, IDIS Solution Suite Compact) and product manual from this link :
-IDIS Website (www.idisglobal.com) > Support > Technical Resources
-Search IDIS Discovery, IDIS Center, IDIS Solution Suite Compact.

Overview

- Product color and design may vary depending on the model.
- For more details on each part name, refer to the manual.

Overview

Body

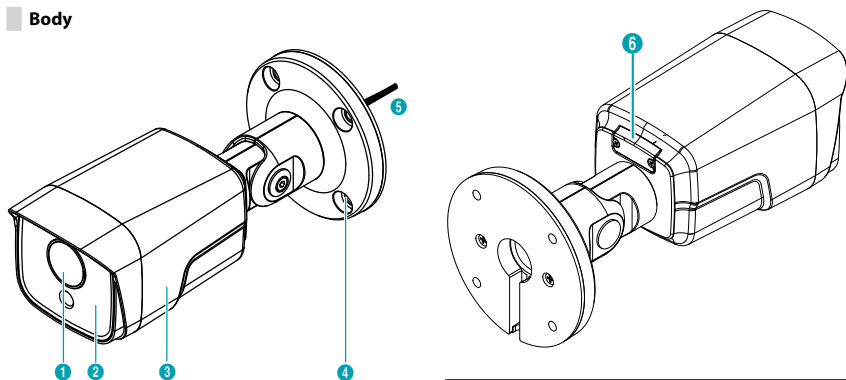

1	Lens
2	IR LED
3	Body
4	Bracket
5	Cable
6	SD Memory Card Slot

Cable

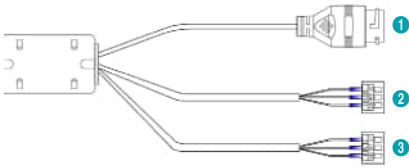

- | | |
|---|--------------|
| 1 | Network Port |
| 2 | Audio In/Out |
| 3 | Alarm In/Out |

Camera Installation

Inserting a SD Memory Card

- 1 Loosen the screws counterclockwise and remove the cover.

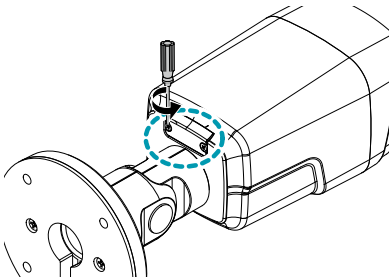

- 2 Insert a SD memory card into the SD memory card slot with the 'micro SD' print facing upward.

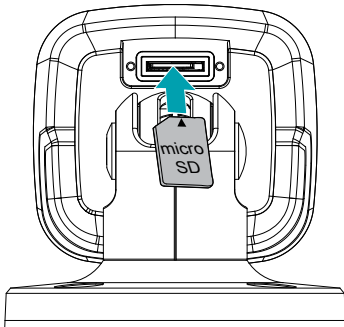

- ✓ Push the SD memory card until it disengages from the slot, and then pull it out.

- ✓  micro SD Logo is a trademark of SD-3C, LLC.

- 3 Close the cover and tighten the screws clockwise.

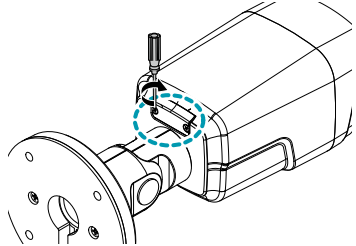

- ✓ Make sure that the cover is joined properly when screwing it; otherwise, the IP67 level is not guaranteed.

Waterproof Cable Installation

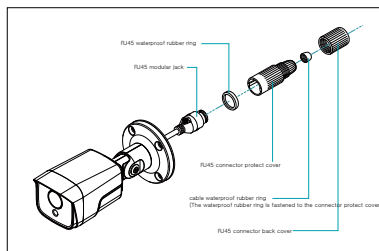

1

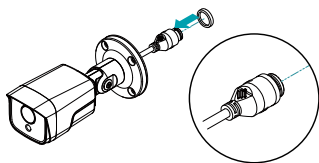

- 1 Insert a round rubber ring (silicone rubber) into the RJ45 jack.

2

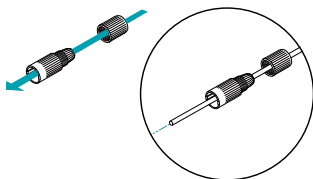

- 2 Insert the network cable into the waterproof cap, rubber bushing, and waterproof cap body in order.

3

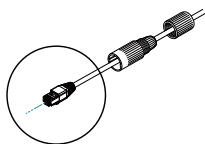

- 3 Plug in the network cable.

4

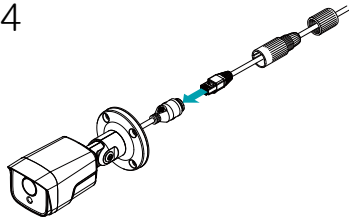

- 4 Connect the plug terminal to the RJ45 jack.

5

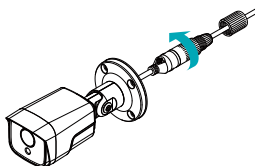

- 5 Push the waterproof cap body and cap into the RJ45 jack and rotate it.

6

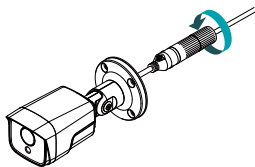

- 6 Lock the waterproof cap into the waterproof cap body.



Not pulling the cable back may cause water to seep in and damage the product.

Installation

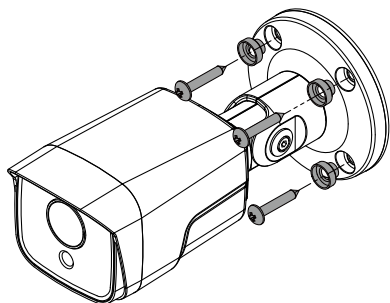

- 1 Screw the mounting bracket to the wall or ceiling by using screws(4) and bushings(4) provided with the camera.
- 2 Adjust the camera angle by bending the stand. After fully assembling the joint screws, unscrew it 2 ~ 2.5 turns again and move the cover of the joints of the left 3 places slightly. (The screws should not be completely released to prevent it from falling.) After adjusting the direction of the camera, turn the screw clockwise to secure it completely.

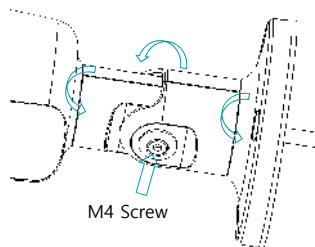

- 3 Connect external devices, network and power adapter.
- 4 Apply power.

Specifications

Vandal Resistance	Yes
Out-door Ready	IP67, IK10
External Dimensions (Ø x H)	90mm X 195.8mm (3.54" x 7.7")
Weight (Main Unit)	0.66 kg (1.44lb)
Working Temperature	-30°C ~ +55°C (-22°F ~ +131°F) (Starting temperature: 32°F to 131°F (0°C to 55°C))
Operating Humidity	0% ~ 90%
Power Input	PoE, IEEE 802.3af(Class 3)
Power Consumption	PoE, IEEE 802.3af(Class 3), 7.9W
Certifications	FCC, CE

- **DirectIP NVR makes it easy to use cameras without extra network configurations. Each camera can be controlled via the DirectIP™ NVR setup menu, without any PC.**
 - For detailed camera settings, please see the camera setting pages of DirectIP™ NVR manual.
- **To use your camera with non-DirectIP system (e.g. other NVR or VMS), refer to the camera manual and it can be downloaded from our website: www.idisglobal.com.**



IDIS Co., Ltd.

For more information, please visit
www.idisglobal.com