



# Installation Guide

Included Installation Instructions

Network Camera **For professional use only!**

Model No. **WV-U1542LA** **Outdoor use**

**WV-U1532LA** **Outdoor use**

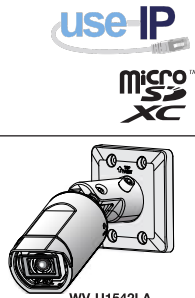

## About the user manuals

Product documentation is composed of the following documents.

- **Installation Guide (this document):** Provides information about "Precautions", "Precautions for installation" and the installation method.
- **Basic Information (in the following manual website):** Provides information about "Precautions for use" and "Detail specifications".
- **Operating Instructions (in the following manual website):** Explains how to perform the settings and how to operate this camera.

\*<Control No.: C\*\*\*\*> used in these documents should be used to search for information on our support website (https://i-pro.com/global/en/surveillance/training\_support/support/technical\_information) and will guide you to the right information.

- Before attempting to connect or operate this product, please read these instructions carefully and save this manual for future use.
- microSDXC/ microSDHC/ microSD memory card is described as microSD memory card.
- The external appearance and other parts shown in this manual may differ from the actual product within the scope that will not interfere with normal use due to improvement of the product.

## For U.S. and Canada:

i-PRO Americas Inc.  
https://www.i-pro.com/

i-PRO EMEA B.V. UK Branch  
1010 Cambourne Business Park,  
Cambridge CB3 6DP  
Authorised Representative in EU:  
i-PRO EMEA B.V.  
Laarderhoogweg 25, 1101 EB  
Amsterdam, Netherlands

© i-PRO Co., Ltd. 2022

## Disposal of Old Equipment and Batteries Only for European Union and countries with recycling systems

These symbols on the products, packaging, and/or accompanying documents mean that used electrical and electronic products and batteries must not be mixed with general household waste. For proper treatment, recovery and recycling of old products and used batteries, please take them to applicable collection points in accordance with your national legislation. By disposing of them correctly, you will help to save valuable resources and prevent any potential negative effects on human health and the environment. For more information about collection and recycling, please contact your local authority. Penalties may be applicable for incorrect disposal of this waste, in accordance with national legislation.

**Note for the battery symbol (bottom symbol)**  
This symbol might be used in combination with a chemical symbol. In this case it complies with the requirement set by the Directive for the chemical involved.

NOTE: This equipment has been tested and found to comply with the limits for a Class A digital device, pursuant to Part 15 of the FCC Rules. These limits are designed to provide reasonable protection against harmful interference when the equipment is operated in a commercial environment. This equipment generates, uses, and can radiate radio frequency energy and, if not installed and used in accordance with the instruction manual, may cause harmful interference to radio communications. Operation of this equipment in a residential area is likely to cause harmful interference in which case the user will be required to correct the interference at his own expense.

For U.S.A.,  
The model number and serial number of this product may be found on the surface of the unit. You should note the model number and serial number of this unit in the space provided and retain this book as a permanent record of your purchase to aid identification in the event of theft.

For Canada,  
CAN ICES-3(A)/NMB-3(A)

Méthode d'installation	Vis de fixation recommandée	La capacité de traction minimale requise
Quand la caméra vidéo est directement installée au plafond ou sur le mur,	M4 × 16 mm (5/8 pouces) / 4 dt. ou M5 × 16 mm (5/8 pouces) / 4 dt.	724 N (163 lbf)

\* La longueur de la vis est un exemple lors de l'installation de la caméra au plafond ou sur un mur robuste d'une épaisseur de 20 mm (25/32 pouces) ou plus.

## Caution:

- The network camera is only intended for a connection to an ethernet or PoE network without routing to the outside plant.
- This product has no power switch. Be sure to install disconnect devices such as a circuit breaker to shut down the main power of power supplying equipment to this product.
- Before attempting to connect or operate this product, please read these instructions carefully.

## Notice:

- This product is not suitable for use in locations where children are likely to be present.
- Do not install this product in locations where ordinary persons can easily reach.
- This product is a professional equipment.
- For information about screws and other parts required for installation, refer to the corresponding section of this document.

Direct current symbol

## Precautions

- **Do not insert any foreign objects.**  
Fire or electrical shock may be caused if water or any foreign objects, such as metal objects, enter inside the unit. Turn the power off immediately and contact qualified service personnel for service.
- **Do not use this product in an inflammable atmosphere.**  
Otherwise, the mounting portions will deteriorate and injury or accidents due to a fall of the product may occur.
- **Avoid installing this product in the locations where salt damage occurs or corrosive gas is produced.**  
Otherwise, the mounting portions will deteriorate and injury or accidents due to a fall of the product may occur.
- **Do not strike or give a strong shock to this product.**  
Failure to observe this may cause injury or fire.
- **Keep microSD memory cards away from infants and children.**  
Otherwise, they may swallow the cards by mistake. In this case, consult a doctor immediately.
- **Do not hang down from this product or use this product as a pedestal.**  
Failure to observe this may cause injury or accidents.
- **Do not install this product on a place that is greatly influenced by wind.**  
Installation on a place where the wind speed is 60 m/s (approx. 134 mph) or more may cause a fall of the product resulting in injury or accidents.

- **Do not sprinkle more water, exceeding the performance limit of waterproof with a high pressure cleaning machine, etc.**  
Fire or electrical shock may be caused by immersion.
- **Do not attempt to disassemble or modify this product.**  
Failure to observe this may cause fire or electric shock. Consult the dealer for the repair or inspections.
- **Do not install or clean the camera, or touch this product, the power cable or the connected cables during thunder storms.**  
Failure to observe this may cause electric shock.
- **Refer installation work to the dealer.**  
Installation work requires technique and experience. Failure to observe this may cause fire, electric shock, injury, or damage to the product. Be sure to consult the dealer.
- **Stop the operation immediately when something is wrong with this product.**  
When smoke goes up from the product, the smell of smoke comes from the product, or the exterior of the product has deteriorated, continued use will cause a fire or fall of the product resulting in injury, or damage to the product. In this case, turn the power off immediately and contact qualified service personnel for service.
- **Select an installation area that can support the total weight.**  
Selecting an inappropriate installation surface may cause the product to fall down or topple over, resulting in injury or accidents. Installation work shall be started after sufficient reinforcement.
- **Periodic inspections shall be conducted.**  
Rust on the metal parts or screws may cause a fall of the product resulting in injury or accidents. Consult the dealer for the inspections.
- **The exclusively designed mount bracket shall be used.**  
Failure to observe this may cause a drop resulting in injury or accidents.

- Use the exclusively designed mount bracket for installation.
- **The screws and bolts must be tightened to the specified torque.**  
Failure to observe this may cause a drop resulting in injury or accidents.
- **Turn the power off when do wiring of this product.**  
Failure to observe this may cause electric shock. In addition, short circuit or wrong wiring may cause fire.
- **Install this product in a location high enough to avoid people and objects from bumping the product.**  
Failure to observe this may cause injury.
- **Do not install this product in locations subject to vibration.**  
Loosening of mounting screws or bolts may cause a fall of the product resulting in injury or accidents.
- **Correctly perform all wiring.**  
Short circuits in the wiring or incorrect wiring may cause fire or electrical shock.
- **The measures of protection against snowfall shall be taken.**  
Weight of snow may cause a fall of the product resulting in injury or accidents. Protect the product against snowfall by installing it under eaves.
- **Install the product securely on a wall or a ceiling in accordance with the installation instructions.**  
Failure to observe this may cause injury or accidents.
- **Do not rub the edges of metal parts with your hand.**  
Failure to observe this may cause injury.
- **When adjusting the angle, do not touch the movable parts by hand.**  
Doing so may cause fingers to get caught, resulting in an injury.
- **Turn the power off when cleaning this product.**  
Failure to observe this may cause injury.

## About notations

The following notations are used when describing the functions limited for specified models. The functions without the notations are supported by all models.

- **U1542** The functions with this notation are available when using the model WV-U1542LA (4M pixel model).
- **U1532** The functions with this notation are available when using the model WV-U1532LA (Full HD model).

## Open Source Software

- This product contains open source software licensed under GPL (GNU General Public License), LGPL (GNU Lesser General Public License), etc.
- Customers can duplicate, distribute and modify the source code of the software under license of GPL and/or LGPL. For details concerning licensing and source code of open source software, click "Click here for OSS information" on "Support" page of the setup menu of this product and read the displayed content.
- Please note that we shall not respond to any inquiries regarding the contents of the source code.

## Copyright

Except for open source software licensed under GPL/LGPL, and so on, distributing, copying, disseminating, reverse compiling and reverse engineering of the software provided with this product are all expressly prohibited. In addition, exporting any software provided with this product violating export laws is prohibited.

## Trademarks and registered trademarks

- Microsoft, Windows, Windows Media, Internet Explorer, Microsoft Edge, and ActiveX are either registered trademarks or trademarks of Microsoft Corporation in the United States and/or other countries.
- Intel and Intel Core are trademarks of Intel Corporation or its subsidiaries in the U.S. and/or other countries.
- Adobe, Acrobat, and Reader are either registered trademarks or trademarks of Adobe in the United States and/or other countries.
- microSDXC Logo is a trademark of SD-3C, LLC.
- iPad and iPhone are trademarks of Apple Inc., registered in the U.S. and other countries.
- Android and Google are trademarks or service marks of Google LLC.
- Firefox is a trademark of the Mozilla Foundation in the US and other countries.
- The word "QR Code" is a registered trademark of DENSO WAVE INCORPORATED in Japan and other countries.
- All other trademarks identified herein are the property of their respective owners.

## Precautions for installation

i-PRO Co., Ltd. assumes no responsibility for injuries or property damage resulting from failures arising out of improper installation or operation inconsistent with this documentation.

■ **In order to prevent injury, the product must be securely mounted to a wall or ceiling according to Installation Guide.**

- **Installation area for this product**  
Select an appropriate place for the installation area (such as a strong wall or ceiling) in your particular environment.
- Make sure that the installation area is strong enough to hold this product, such as a concrete ceiling.
- Install the camera in the foundation area of the architecture or where sufficient strength is assured.
- Do not mount the product on a plaster board or a wooden section because they are too weak. If the product is unsuitably mounted on such a section, the section shall be sufficiently reinforced.

- **Do not place this product in the following places**
  - Locations where a chemical agent is used such as a swimming pool
  - Locations subject to moisture or oil smoke such as a kitchen
  - Locations that have a specific environment that is subject to an inflammable atmosphere or solvents
  - Locations where a radiation, an X-ray, a strong radio wave or a strong magnetic field is generated
  - Locations near coasts directly subjected to sea breezes, or locations subject to corrosive gases such as from hot springs, volcanic regions, etc.
  - Locations where the temperature is not within the specified range
  - Locations subject to vibrations, such as on vehicles, marine vessels; or above product lines (This product is not designed for on-vehicle use.)
  - Locations subject to condensation as the result of severe changes in temperature
- Locations near rubber products (packing, rubber feet, etc.)

- **Screw tightening**  
Do not use an impact driver. Use of an impact driver may damage the screws or cause tightening excessively.
- **About reflection of light from outside or IR light**  
A ghost may appear on the screen depending on the incident angle of external light. In the case of using the IR light, installation of a camera near a wall may cause reflection of infrared rays resulting in a part of the screen or the entire screen turning whitish.
- **Take notice of humidity**  
Install this product when the humidity is low. If installation is performed when it is raining or in very humid conditions, the inside may be affected by humidity, causing mist-over inside the front panel.
- **Protection from lightning**  
When cables are used outdoors, there is a chance that they may be affected by lightning. In such a case, install a lightning arrestor close to the camera, and make the length of the network cable between the camera and lightning arrestor as short as possible to prevent the camera from being affected by lightning.

- **When noise disturbance may happen**  
Noise may appear in video or audio near a strong electric field from a TV or radio antenna, motors and transformers, or a strong electric field/magnetic field from a power line (lamp line) of AC100 V or more. Conduct the power distribution work to keep 1 m (3,28 feet) away from them or conduct the electric conduit work using metal pipes. (Be sure to make ground connection of the metal pipes.)
- **Make sure to remove this product if it will no longer be used.**
- **This product has no power switch.**  
When turning off the power, disconnect the power supply from the PoE device.
- **About the battery**  
A battery is installed inside the camera. Do not leave the battery exposed in environments of excessive heat as a result of sunlight or fire.
- **Equipment classification and power source indication label**  
Refer to the indication label on the bottom side of this unit for the equipment classification, power source, and other information.

## Troubleshooting

Before requesting service, refer to "Troubleshooting" of Basic Information and Operating Instructions. Then, confirm the trouble.

Specifications	*For further information, refer to the Basic Information.	
Power source *1:	PoE (IEEE802.3af compliant)	
Power consumption *1:	PoE DC 48 V : 150 mA/ Approx. 7.2 W (Class 0 device)	U1542
	PoE DC 48 V : 140 mA/ Approx. 6.7 W (Class 0 device)	U1532
Operating environment	-30 °C to +50 °C (-22 °F to +122 °F) (Power On range: -20 °C to +50 °C (-4 °F to +122 °F))	
Ambient operating temperature:	-30 °C to +50 °C (-22 °F to +122 °F) (Power On range: -20 °C to +50 °C (-4 °F to +122 °F))	
Ambient operating humidity:	10 % to 100 % (no condensation)	
Storage environment	Storage temperature: -30 °C to +60 °C (-22 °F to +140 °F) Storage humidity: 10 % to 95 % (no condensation)	
Waterproof *1:	IP66 (IEC 60529), Type 4X (UL50E) NEMA 4X compliant	
Shock resistance:	IK10 (IEC 62262)	
Wind resistance:	Up to 40 m/s (approx. 89 mph)	
Dimensions:	112.5 mm (W) × 112.5 mm (H) × 262 mm (D) (4-7/16 inches (W) × 4-7/16 inches (H) × 10-5/16 inches (D))	
Mass:	Approx. 850 g (1.90 lbs)	
Finish:	Main body : Aluminum die cast/ PC resin, i-PRO white Outer fixing screws : Stainless steel (Corrosion-resistant treatment) Front panel : Polycarbonate resin, Clear	

- \*1 Refer to our support website <Control No.: C0106> for further information about Power source and Power consumption information.
- \*2 Only when installation work is properly performed according to the Installation Guide and appropriate waterproof treatment is performed.

## Optional accessories<sup>1</sup>

	<+PRO white brackets>	<Light gray brackets>	<Silver brackets>
Adapter box:	WW-QJB500-W <sup>2</sup>	WW-QJB500-G <sup>2</sup>	WW-QJB500-S <sup>2</sup>
Pole mount bracket:	WW-QR1500-W <sup>2</sup>	-	WW-Q188
Corner mount bracket:	WW-QCN500-W <sup>2</sup>	-	WW-Q199

- \*1 Refer to our support website <Control No.: C0501> for further information about optional accessories.
- \*2 Scheduled to be released soon. Refer to our support website <Control No.: C0501> for further information.

## Standard accessories

Installation Guide (this document), ..... 1 pc. Code label<sup>1</sup>, ..... 1 pc.  
IMPORTANT SAFETY INSTRUCTIONS, ..... 1 pc.

\*1 This label may be required for network management. Use caution not to lose this label.

The following parts are used during installation procedures.  
RJ45 waterproof connector cover, ..... 1 pc.  
RJ45 waterproof connector cap, ..... 1 pc.

## Other items that are needed (not included)

Installation method	Recommended screw <sup>1</sup>	Minimum pull-out strength <sup>2</sup>
Directly mount Directly mount the camera onto the ceiling or wall.	M4 × 16 mm (5/8 inches) <sup>1)</sup> 4pcs.	724 N (163 lbf)
Gangbox/Junction box Mount the camera to a gangbox / junction box.	M4 × 16 mm (5/8 inches) <sup>1)</sup> 4pcs.	724 N (163 lbf)
Adapter box Mount the camera using the WW-QJB500-W.	M4 screws/ 4pcs. (accessory of WW-QJB500-W)	1.37 N·m (1.01 lbf ft)

- \*1 Select screws according to the material of the location that the camera will be mounted to. In this case, wood screws and nails should not be used.
- \*2 This value indicates the minimum pull-out strength required value per screw. For information about the minimum pull-out strength, refer to our support website <Control No.: C0120>.
- \*3 The screw length is an example when installing the camera on a robust installation surface with a thickness of 20 mm (25/32 inches) or more.
- \*4 Prepare a M4 screw with a washer with a diameter of 7.5 mm (9/32 inches) to 10 mm (13/32 inches) and a spring washer.

- RJ45 plug, Ethernet cable (category 5e or better, straight, all 4 pairs (8 pins))
- Tools

## Parts and functions

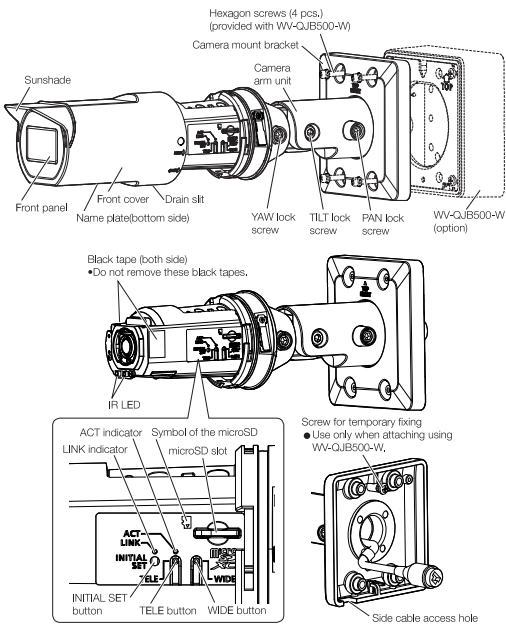

### ■Indicators

#### Note:

- Lighting/blinking LED can be turned off with the software settings at any time. (The initial state is lighting or blinking.) Refer to the Operating instructions, and set the LED to be solid off if necessary.

#### LINK indicator

When the camera is able to communicate with the connected device | Lights orange

#### ACT indicator

When data is being sent via the network camera | Flashes green (accessing)

### ■Buttons

#### ●INITIAL SET button (Initializing)

Follow the steps below to initialize the network camera. Retry if the camera does not start up normally.

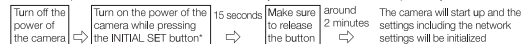

\*Do not turn off the power of the camera during the process of initialization. Otherwise, it may fail to initialize and may cause malfunction.

#### ●TELE button

Click the TELE button to adjust the zoom ratio to the "Tele" side.

#### ●WIDE button

Click the WIDE button to adjust the zoom ratio to the "Wide" side.

## Step3 Mount the camera (Fix in accordance with the installation method)

### Directly mount | Secure the camera with fixing screws (4 pcs.) (M4:locally procured).

Minimum pull-out strength: 724 N (163 lbf) (per 1 pc.).

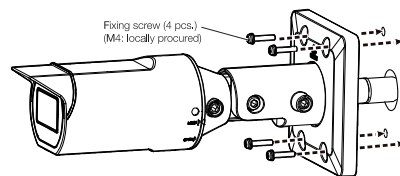

### Gangbox/ Junction box

#### Secure the camera with fixing screws (4 pcs.) (M4:locally procured).

Minimum pull-out strength: 724 N (163 lbf) (per 1 pc.).

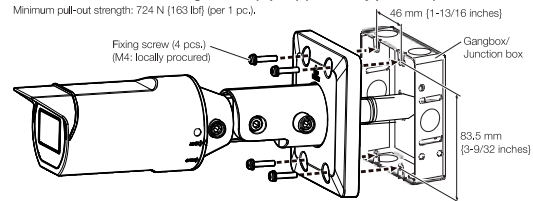

### Adapter box | Using a 3 mm {1/8 inches} hex wrench (locally procured), secure the camera with hexagon screws (4 pcs.) (M4:accessory of WV-QJB500-W).

Recommended tightening torque: 1,37 N·m {1,01 lbf ft}

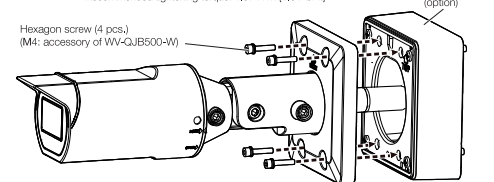

## Step1 Processing the installation surface (Process in accordance with the installation method)

### Common

When not using WV-QJB500-W, remove the screw for temporary fixing.

- Determine the mounting height of the camera so that the lowest part of the camera or the camera mount bracket after the installation is 2 m 80 cm (110 inches) or higher from the floor.

### Directly mount

Drill a hole in the installation surface, (4 screw holes / 1 cable access hole).

#### <When mounting on a wall>

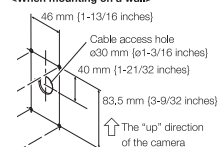

#### <When mounting on a ceiling>

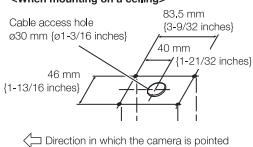

#### Note:

- When running the cable using the side cable access hole of the camera, the cable access hole indicated in the upper figure is not required.
- To install this product outdoors, be sure to waterproof screw holes and cable access holes.

### Gangbox/ Junction box | Mount the gangbox/ junction box on the installation surface.

#### Note:

- When gangbox/ junction box or the like are used, it is recommended that 2 pieces be used side by side. (Cable connection will become easy by fixing the camera on one side and wiring on the other side.)

### Adapter box

- 1] Install on the installation surface by following the operating instructions of WV-QJB500-W (option).
- 2] Hang the camera by hooking the installed auxiliary wire on the hook on the rear of the camera mount bracket as shown in the illustration on the right.

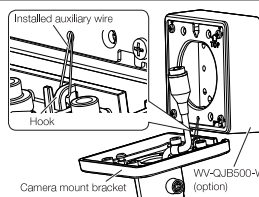

## Step2 Making connections

### IMPORTANT:

- Devices to which power can be supplied to this product are PoE hub and PoE power supplying equipment.
- Turn off each system's power supply before making a connection.

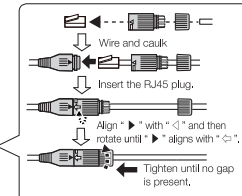
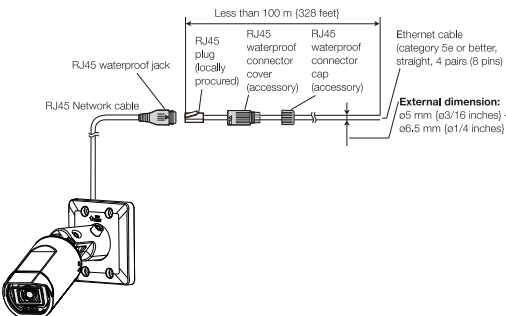

### IMPORTANT:

- Do not install the camera where the RJ45 waterproof connector is exposed to constant rain or moisture.
- When removing the RJ45 waterproof connector, be sure to remove it with the reverse procedure of connection.
- When the Ethernet cable is disconnected once, reconnect the cable after around 2 seconds. When the cable is quickly reconnected, the power may not be supplied from the PoE device.

## Step4 Adjustment

### [1] Turn on the camera.

[2] Connect to the network by following information described on our support website <Control No.: C0123>.

### [3] Adjust the camera direction.

- ① Using a 5 mm (3/16 inches) hex wrench (locally procured), loosen TILT lock screw, PAN lock screw and YAW lock screw.
- ② Adjust the horizontal (PAN) angle, vertical (TILT) angle, and azimuth (YAW) angle while watching the screen of the PC on the network.

### IMPORTANT:

- Do not adjust the Horizontal (PAN) angle more than ±180°. This may cause cables to be wrenched.

- ③ After adjusting the direction, fix the camera by tightening the TILT lock screw, PAN lock screw and YAW lock screw.

### [4] Remove the front cover from the camera.

- ① Rotate the front cover while pressing the spring plate with a thin tool.
- ② Pull the front cover forward.

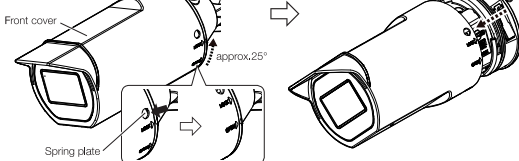

### [5] If necessary, insert a microSD memory card by referring to "Insert / remove a microSD memory card".

### [6] Adjust the zoom ratio of the camera.

Adjust the zoom ratio using the TELE button and the WIDE button while watching the screen.

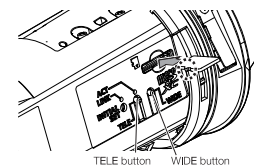

#### Note:

- After approx. 3 seconds from releasing the TELE button or the WIDE button, the auto focus function will automatically be executed. Do not touch the camera during execution of the auto focus function.
- Attaching the front cover may cause slight defocusing. In this case, execute the auto focus function from the setup menu after attaching the front cover and removing the protection film.
- When the resolution is set to higher than 640×360, image quality may deteriorate depending on the zoom ratio. Refer to our support website <Control No.: C0124> for further information.

### [7] Mount the front cover to the camera

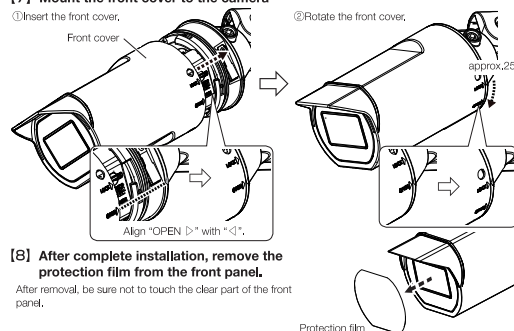

### [8] After complete installation, remove the protection film from the front panel.

After removal, be sure not to touch the clear part of the front panel.

## Insert / remove a microSD memory card

### ■ Insert a microSD memory card

- ① Remove the front cover from the camera.
- ② Insert the microSD memory card into the end of the microSD slot and confirm that a clicking sound is made.

#### Note:

- Back end of the microSD memory card does not protrude over the surface of the microSD slot (the same surface as the symbol of the microSD).

- ③ Attach the front cover to the camera again.

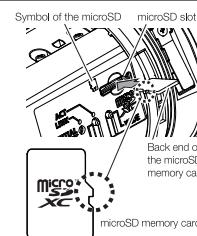

### ■ Remove a microSD memory card

When removing a microSD memory card, reverse the procedure.

- ① Remove the front cover from the camera.
- ② Remove the microSD memory card by pushing it down until a click sound is heard while holding the card with a finger to prevent it from popping out.
- ③ Attach the front cover to the camera again.

### IMPORTANT:

- When removing a microSD memory card, make sure to set "SD memory card" to "Not use" on the [SD memory card] tab of the setup menu before removing the microSD memory card. After removing the memory card, set back the "SD memory card" to "Use". For information about the setup menu, refer to the Operating Instructions.

#### Note:

- When using a microSD memory card, format it using this product. Refer to the Operating Instructions for how to format a microSD memory card.
- Use the compatible microSD memory cards. Refer to our support website <Control No.: C0107> for latest information about the compatible microSD memory cards.