

## Operating Instructions

### Network Camera

---

Model No. WV-U2500 Series  
WV-U1500 Series  
WV-U2100 Series  
WV-U1100 Series



WV-U1142A



WV-U2142LA

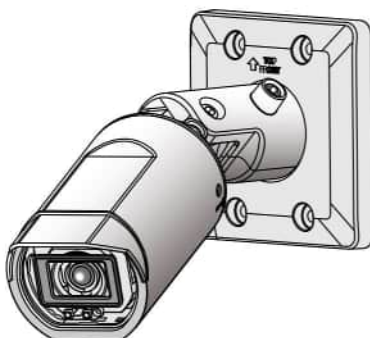

WV-U1542LA



WV-U2542LA

The model number is abbreviated in some descriptions in this manual.

This manual covers the models: WV-U2500 Series (WV-U2542LA, WV-U2540LA, WV-U2532LA, WV-U2530LA), WV-U1500 Series (WV-U1542LA, WV-U1532LA), WV-U2100 Series (WV-U2142LA, WV-U2140LA, WV-U2132LA, WV-U2130LA), WV-U1100 Series (WV-U1142A, WV-U1132A, WV-U1130A).



# Preface

## About the user manuals

There are 3 sets of operating instructions as follows.

- Operating Instructions (this document): Explains how to perform the settings and how to operate this camera.
- Basic Information: Provides information about “Precautions for use” and “Detail specifications”.
- Installation Guide: Provides information about “Precautions”, “Precautions for installation” and the installation method.

The screens used in these operating instructions show the case of WV-U2132LA. Depending on the model used, the screens shown in the explanations may differ to the actual camera screens.

### Note

- “Control No.:C\*\*\*\*” used in this document should to be used to search for information on our support website below.  
[https://i-pro.com/global/en/surveillance/training\\_support/support](https://i-pro.com/global/en/surveillance/training_support/support)
- The captured screens are used based on the guideline by Microsoft Corporation.
- Operations using Internet Explorer 11 is described in this document.
- Covered by one or more claims of the HEVC patents listed at [patentlist.accessadvance.com](http://patentlist.accessadvance.com).
- The default settings of some of the stream-related settings vary as follows depending on the language setting of the browser selected at the time of administrator registration.

Setting items	Language of the browser	
	Languages other than Japanese	Japanese
Transmission priority	VBR	Frame rate
Image quality	3	Normal
Stream(1) -Max bit rate (per client)	<b>WV-U1142A/ WV-U2142LA/ WV-U2140LA/ WV-U1542LA/ WV-U2542LA/ WV-U2540LA</b> 10240kbps * <b>WV-U1132A/ WV-U1130A/ WV-U2132LA/ WV-U2130LA/ WV-U1532LA/ WV-U2532LA/ WV-U2530LA</b> 6144kbps *	<b>WV-U1142A/ WV-U2142LA/ WV-U2140LA/ WV-U1542LA/ WV-U2542LA/ WV-U2540LA</b> 6144kbps * <b>WV-U1132A/ WV-U1130A/ WV-U2132LA/ WV-U2130LA/ WV-U1532LA/ WV-U2532LA/ WV-U2530LA</b> 3072kbps *
Stream(2) -Max bit rate (per client)	1536kbps *	768kbps *
Stream(3) -Max bit rate (per client)	768kbps *	384kbps *

## About notations

The following notations are used when describing the functions limited for specified models. The functions without the notations are supported by all models.

Notation	Model	Notation	Model
<b>U114x</b>	WV-U1142A	<b>U113x</b>	WV-U1132A/WV-U1130A
<b>U214x</b>	WV-U2142LA/ WV-U2140LA	<b>U213x</b>	WV-U2132LA/ WV-U2130LA
<b>U154x</b>	WV-U1542LA	<b>U153x</b>	WV-U1532LA
<b>U254x</b>	WV-U2542LA/ WV-U2540LA	<b>U253x</b>	WV-U2532LA/ WV-U2530LA

## Abbreviations

The following abbreviations are used in these operating instructions.

Microsoft Windows 10 is described as Windows 10.

Microsoft Windows 8.1 is described as Windows 8.1.

Internet Explorer 11 is described as Internet Explorer.

microSDXC/microSDHC/microSD memory card is described as SD card or SD memory card.

Universal Plug and Play is described as UPnP™ or UPnP.

## For administrator registration

At the time of first access to the camera (or at the time of initialization), the registration screen will be displayed.

### Administrator registration

Enter the user name and password of the administrator.

User name (1 to 32 characters)	<input style="width: 90%; height: 20px;" type="text"/>
Password (8 to 32 characters)	<input style="width: 90%; height: 20px;" type="password"/>
Retype password	<input style="width: 90%; height: 20px;" type="password"/>

Note:

- (1) Distinguish between upper- and lower cases.
- (2) Entry of the following is not allowed as a user name: 2-byte characters, and 1-byte symbols " & ; \
- (3) Entry of the following is not allowed as a password: 2-byte characters, and 1-byte symbols " &
- (4) For the password, use three or more types of characters from upper- and lowercase alphabetic characters, numbers, and symbols.
- (5) Keep the user name and password at hand so as not to lose.
- (6) It is recommended to change the password periodically.
- (7) Set the password which does not include the user name.

**[User name (1 to 32 characters)]**

Enter the user name of the administrator.

**Available number of characters:** 1 - 32 characters

**Unavailable characters:** 2-byte characters, and 1-byte symbols " & ; \

**[Password (8 to 32 characters)]/[Retype password]**

Enter the administrator password.

**Available number of characters:** 8 - 32 characters

**Unavailable characters:** 2-byte characters, and 1-byte symbols " &

**Note**

- Distinguish between upper- and lower cases.
- For the password, use three or more types of characters from upper- and lowercase alphabetic characters, numeric characters, and symbols.
- Set the password which does not include the user name.

**IMPORTANT**

- If you forgot or do not know the password or user name, the camera must be initialized. Because all settings other than preset position settings are deleted when the camera is initialized, make sure to keep the information secure from third parties. Refer to “Parts and functions” section in the Installation Guide for more information about initializing the camera.
- It is recommended to change the password periodically.
- Do not use the password already used for other camera or device.

The registration completion screen will be displayed after registering a user name and password of the administrator. After 10 seconds, the camera will be reconnected automatically. Please click “here” if it is not displayed automatically.

When the camera is reconnected to, an authentication window is displayed. Enter the registered user name and password to start operation.

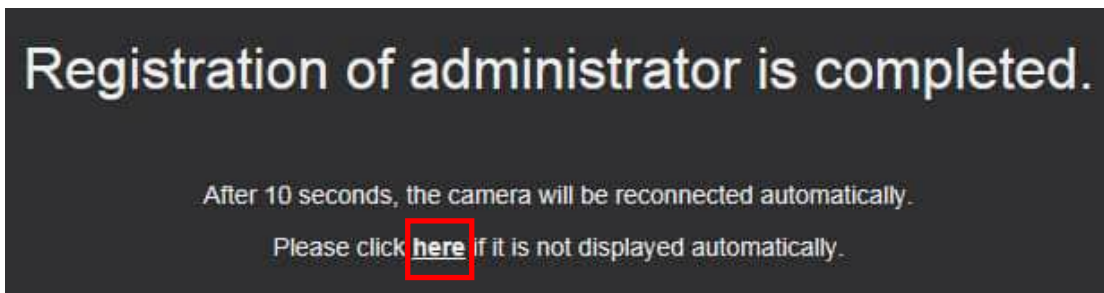

## Viewer software

In order to display H.265 (or H.264) images and play images saved on the SD memory card, the “Network Camera View 4S” (ActiveX®) viewer software must be installed. Install this Viewer Software directly from the

camera (→1.1.2 About the “Live” page), or download the viewer software with the installer to a PC and install (→2.4.1 Configure the basic settings [Basic]).

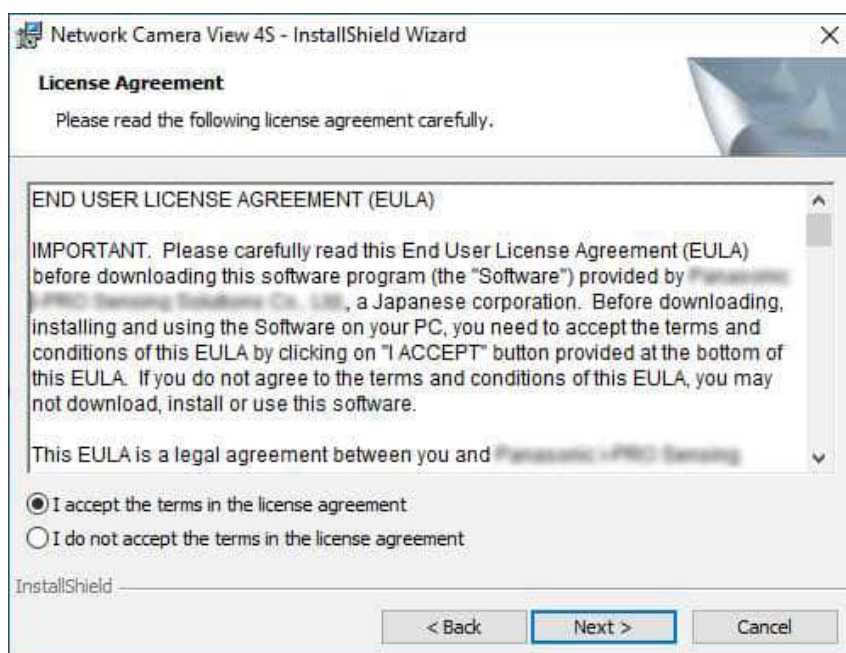

## IMPORTANT

- The default setting of “Automatic installation” is “On”. Follow the instructions on “Information Bar” when the message is displayed on the information bar of the browser.
- Depending on the software environment of your PC, it may take time for the message to be displayed on the information bar of the browser.
- If you display the “Live” page on a PC and click the [Viewer Software] button, the installation screen for Viewer Software, which is required for viewing camera images, is displayed. Follow the on-screen instructions and install the software. When displayed JPEG images (still images), there is no need to install Viewer Software.
- When the install wizard is displayed again even after completing the installation of the Viewer Software, restart the PC.
- The viewer software used on each PC should be licensed individually. The number of installations of the viewer software from the camera can be checked on the [Upgrade] tab of the “Maintenance” page (→“2.10.2 Upgrade the firmware [Upgrade]”). Refer to your dealer for the software licensing.

# Table of Contents

- 1 Operations .....9**
- 1.1 **Monitor images on a PC .....9**
  - 1.1.1 Monitor images from a single camera .....9
  - 1.1.2 About the “Live” page .....13
- 1.2 **Monitor images on a mobile terminal/tablet device .....17**
  - 1.2.1 Monitor images on a mobile terminal (including smartphones) .....17
  - 1.2.2 Monitor images on a tablet device .....19
- 1.3 **Record images on the SD memory card manually .....24**
- 1.4 **Action at an alarm occurrence .....25**
  - 1.4.1 Alarm type .....25
  - 1.4.2 Action at an alarm occurrence .....25
- 1.5 **Display the log list .....27**
- 1.6 **Playback of images on the SD memory card .....31**
  - 1.6.1 Playback “Stream(1)”/“Stream(2)”/“Stream(3)” images saved to the SD memory card .....31
- 2 Settings .....34**
- 2.1 **About the network security .....34**
  - 2.1.1 Equipped security functions .....34
- 2.2 **Display the setup menu from a PC .....35**
  - 2.2.1 How to display the setup menu .....35
  - 2.2.2 How to operate the setup menu .....35
  - 2.2.3 About the setup menu window .....37
- 2.3 **Use Easy Setup [Easy Setup] .....39**
  - 2.3.1 Configure the Internet settings [Internet] .....39
  - 2.3.2 Configure an event action [Event action] .....40
    - 2.3.2.1 Configure the schedule/alarm (event function type setup menu) .....42
    - 2.3.2.2 Alarm: Configure the VMD and the SCD (alarm setup menu) .....43
    - 2.3.2.3 Alarm: Configure the alarm function type (Alarm function type setup menu) .....44
    - 2.3.2.4 Alarm: Configure the details for SD memory recording conditions .....45
    - 2.3.2.5 Alarm: configure the mail notifications and mail server .....45
    - 2.3.2.6 Schedule: Configure SD recording (schedule function type setup menu) .....47
    - 2.3.2.7 Schedule: Set SD memory recording (video recording setup menu) .....47
- 2.4 **Configure the basic settings of the camera [Basic] .....51**
  - 2.4.1 Configure the basic settings [Basic] .....51
  - 2.4.2 Configure the settings relating to the SD memory card [SD memory card] .....59
  - 2.4.3 Configure the directory of the PC that images will be downloaded to [Log] .....64
- 2.5 **Configure the settings relating to images [Image] .....65**
  - 2.5.1 Configure the settings relating to the image capture mode [Image] .....65
  - 2.5.2 Configure the settings relating to JPEG images [Image] .....66
  - 2.5.3 Configure the settings relating to Stream [Image] .....70
  - 2.5.4 Configure the settings relating to image adjust, zoom/focus, extra zoom, privacy zone, VIQS [Image quality] .....77
    - 2.5.4.1 Configure the settings relating to image quality (“Image adjust” setup menu) .....78
    - 2.5.4.2 Set mask areas .....86
    - 2.5.4.3 Adjust the zoom and focus [WV-U2542LA] [WV-U2532LA] [WV-U1542LA] [WV-U1532LA] [WV-U2142LA] [WV-U2132LA] [WV-U1142A] [WV-U1132A] .....88
    - 2.5.4.4 Adjust the angular field of view with extra zoom [WV-U2540LA] [WV-U2530LA] [WV-U2140LA] [WV-U2130LA] [WV-U1130A] .....91
    - 2.5.4.5 Configure the settings relating to the privacy zone (“Privacy zone” setup menu) .....92
    - 2.5.4.6 Configure the VIQS setting .....94

2.5.4.7	Configure the VIQS area .....	96
<b>2.6</b>	<b>Configure the alarm settings [Alarm] .....</b>	<b>98</b>
2.6.1	Configure the settings relating to the alarm action [Alarm] .....	98
2.6.2	Configure the settings relating to the camera action on alarm occurrence [Alarm] .....	99
2.6.2.1	Configure settings relating to alarm E-mail notifications .....	100
2.6.2.2	Configure settings relating to recording to an SD memory card when an alarm occurs .....	101
2.6.2.3	Configure settings relating to TCP alarm notification when an alarm occurs .....	102
2.6.2.4	Configure settings relating to HTTP alarm notification when an alarm occurs .....	103
2.6.2.5	Configure settings relating to SNMP transmissions of alarm images .....	104
2.6.3	Configure the VMD settings [VMD area] .....	104
2.6.4	Set the VMD areas [VMD area] .....	106
2.6.5	Configure the SCD settings [SCD area] .....	108
2.6.6	Set the SCD areas [SCD area] .....	110
2.6.7	Configuration of the settings relating to alarm notification [Notification] .....	111
2.6.7.1	Configure the settings relating to TCP alarm notification .....	112
2.6.7.2	Configure the settings relating to HTTP alarm notification .....	114
<b>2.7</b>	<b>Configure the settings relating to the authentication [User mng.] .....</b>	<b>116</b>
2.7.1	Configure the settings relating to the user authentication [User auth.] .....	116
2.7.2	Configure the settings relating to the host authentication [Host auth.] .....	119
2.7.3	Configure IEEE 802.1X [IEEE 802.1X] .....	120
<b>2.8</b>	<b>Configuring the network settings [Network] .....</b>	<b>125</b>
2.8.1	Configure the network settings [Network] .....	125
2.8.2	Configure advanced network settings [Advanced] .....	130
2.8.2.1	Configure the settings related to sending E-mails .....	131
2.8.2.2	Configure the settings relating to the NTP server .....	134
2.8.2.3	Configure the UPnP settings .....	136
2.8.2.4	Configure the HTTPS settings .....	137
2.8.2.5	Configure the settings relating to DDNS .....	139
2.8.2.6	Configure the settings relating to SNMP .....	140
2.8.2.7	Configure the QoS settings .....	144
2.8.3	How to configure HTTPS settings .....	145
2.8.3.1	Select the certificate to use when accessing with HTTPS .....	146
2.8.3.2	Obtaining the root certificate .....	146
2.8.3.3	Configuration of HTTPS connections .....	152
2.8.3.4	Generation of the CRT key (SSL encryption key) .....	153
2.8.3.5	Generation of CSR (Certificate Signing Request) .....	154
2.8.3.6	Installation of the CA certificate .....	155
2.8.4	Access the camera using the HTTPS protocol (for pre-installed certificate) .....	156
2.8.4.1	Configuration of the host file .....	156
2.8.5	Access the camera using the HTTPS protocol (for CA Certification) .....	161
2.8.6	How to configure the settings relating to DDNS .....	162
2.8.6.1	When using the "Viewnetcam.com" service .....	164
2.8.6.2	When using "Dynamic DNS Update" .....	166
2.8.6.3	When using "Dynamic DNS Update(DHCP)" .....	167
<b>2.9</b>	<b>Configure the settings relating to the schedules [Schedule] .....</b>	<b>168</b>
2.9.1	How to delete the set schedule .....	172
<b>2.10</b>	<b>Maintenance of the camera [Maintenance] .....</b>	<b>174</b>
2.10.1	Check the system log [System log] .....	174
2.10.2	Upgrade the firmware [Upgrade] .....	174
2.10.3	Check the status [Status] .....	176
2.10.4	Reset the settings/Reboot the camera [Default reset] .....	179
2.10.5	Settings data/backing up or restoring logs [Data] .....	180
<b>2.11</b>	<b>Display our support website [Support] .....</b>	<b>181</b>

<b>3</b>	<b>Others .....</b>	<b>182</b>
3.1	About the displayed system log .....	182
3.2	Troubleshooting .....	186

# 1 Operations

## 1.1 Monitor images on a PC

The following are descriptions of how to monitor images from the camera on a PC.

### 1.1.1 Monitor images from a single camera

1. Start up the web browser.
2. Enter the IP address designated using the “IP Setting Software” in the address box of the browser.
  - **Example when entering an IPv4 address:** http://URL registered using IPv4 address  
http://192.168.0.10/
  - **Example when entering an IPv6 address:** http://[URL registered using IPv6 address]  
http://[2001:db8::10]/

#### <Example of IPv4 access>



#### <Example of IPv6 access>

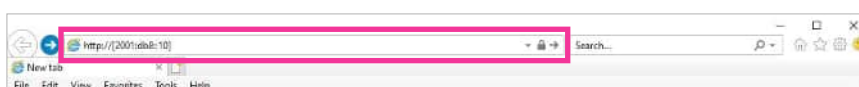

### IMPORTANT

- When the HTTP port number is changed from “80”, enter “http://IP address of the camera + : (colon) + port number” in the address box of the browser. (Example: http://192.168.0.11:8080)
- When the PC is in a local network, configure the proxy server setting of the web browser (under [Internet Options...] under [Tools] of the menu bar) to bypass the proxy server for the local address.

### Note

- Refer to “2.8.4 Access the camera using the HTTPS protocol (for pre-installed certificate)” and “2.8.5 Access the camera using the HTTPS protocol (for CA Certification)” for further information about the case in which “HTTPS” is selected for “HTTPS” - “Connection” on the [Advanced] tab of the “Network” page (→“2.8.1 Configure the network settings [Network]”).

- 3. Press the [Enter] key on the keyboard.  
→ The window with the user name and password entry fields will be displayed.

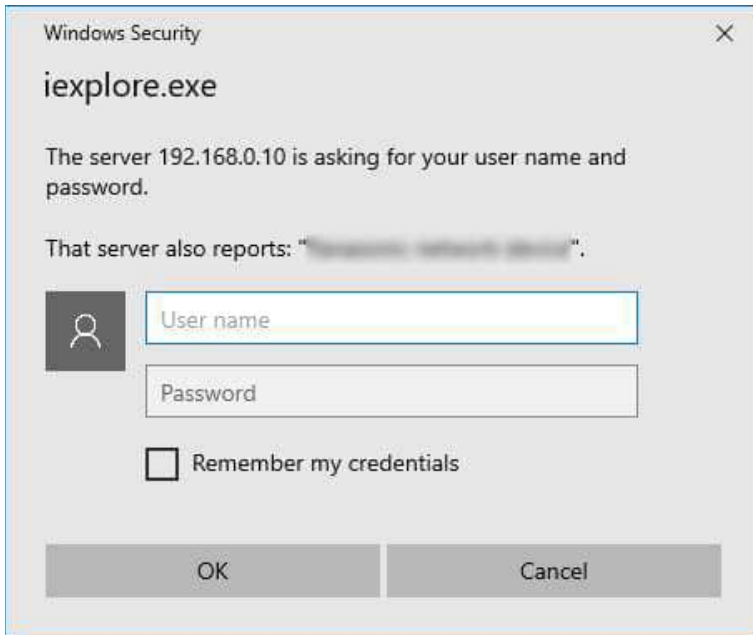

**Note**

- When "Off" is selected for "User auth.", the authentication window will not be displayed before displaying live images for the user name and password entries.
- 4. Click the [OK] button after entering the user name and the password.  
→ The "Live" page will be displayed. Refer to "1.1.2 About the "Live" page" for further information about the "Live" page.







**IMPORTANT**

- It is recommended to change the password periodically.
- When displaying multiple H.265 (or H.264) images on a PC, images may not be displayed depending on the performance of the PC.

**Note**

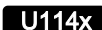
- The maximum number of concurrent access user is 14 including users who is receiving H.265 (or H.264) images and users who are receiving JPEG images. Depending on the set values for “Bandwidth control(bit rate)” and “Max bit rate (per client)\*”, the maximum concurrent access number may be 14 or less users. When 14 users are concurrently accessing, the access limit message will be displayed for users who subsequently attempt to access. When “Multicast” is selected for “Transmission type” of “Stream”, only the first user who accessed to monitor H.265 (or H.264) images will be included in the maximum number. The second and subsequent users who are monitoring H.265 (or H.264) images will not be included in the maximum number.
- When performing a recording of a stream with a high bit rate on the SD memory card, there may be cases where live image of the same stream cannot be displayed. When it is necessary to display the live images of the stream, improve by performing either of the following.
  - Lower the bit rate of the stream being recorded on the SD memory card.
  - Monitor live images of other stream or JPEG live images.
- The maximum refresh interval of JPEG(1) will be as follows.
  - When 30 fps is set for [Image capture mode], the maximum refresh interval will be 10 fps.
  - When 25 fps is set for [Image capture mode], the maximum refresh interval will be 8.3 fps.
- If you set the “Stream transmission” (→“Stream(1)/ Stream(2)/ Stream(3)”) to “On”, an H.265 (or H.264) image will be displayed based on the settings of the “Stream encoding format”. If you set the “Stream transmission” (→“Stream(1)/ Stream(2)/ Stream(3)”) to “Off”, a JPEG image will be displayed. A JPEG image can be displayed even if the “Stream transmission” is set to “On”, but in that case, the refresh interval of the JPEG image will be restricted as follows. Even when “Off” is set for “Stream transmission”, the maximum refresh interval of JPEG(1) will be 10 fps in the 30 fps mode and 8.3 fps in the 25 fps mode. When “16:9 mode (2688x1520 30fps mode)” or “16:9 mode (2688x1520 25fps mode)” is selected for “Image capture mode”, JPEG(2) is not available.

Image capture mode	Stream transmission	
	On	Off
16:9 mode(30fps mode)	max. 3 fps	max. 30 fps
16:9 mode (2688x1520 30fps mode)    	max. 3 fps	max. 10 fps
4:3 mode(30fps mode)	max. 3 fps	max. 30 fps
16:9 mode(25fps mode)	max. 3.1 fps	max. 25 fps

## 1 Operations

---

16:9 mode (2688x1520 25fps mode) <b>U154x</b> <b>U254x</b> <b>U114x</b> <b>U214x</b>	max. 3.1 fps	max. 8.3 fps
4:3 mode(25fps mode)	max. 3.1 fps	max. 25 fps

- The refresh interval may become longer depending on a network environment, PC performance, photographic subject, access traffic, etc.

## 1.1.2 About the “Live” page

### Note

- The buttons and setting items displayed on the “Live” page can be changed depending on the user rights of the accessing user. You can set the user right settings from “User auth.” under “User mng.”. (→“2.7.1 Configure the settings relating to the user authentication [User auth.]”)



### ① [select language] pull-down-menu

The camera’s display language can be selected. The default language can be set in the [Menu language] in the [Basic] settings. (→“2.4.1 Configure the basic settings [Basic]”)

### ② [Login] button

This button is displayed when “User auth.” is “On” and a person other than the administrator logs in, or when “User auth.” is “Off” and “Guest User” is set to “Use”. (→“2.7.1 Configure the settings relating to the user authentication [User auth.]”)

Even in the above case, the [Login] button will not be displayed if “Host auth.” is set to “On”, and the camera browser is opened from a host with administrator rights.



If login fails, close all the browsers, open the “Live” page and login once again.

### ③ [Setup] button<sup>1</sup>

Displays the setup menu.

### ④ [Live view] pull-down menu

You can select and switch to the image to be displayed in the main area from the following:

Stream(1)/Stream(2)/Stream(3)/JPEG(1)/JPEG(2)

The image in the main area is displayed based on the contents set in Stream(1) – (3) (→“Stream(1)/Stream(2)/ Stream(3)”), JPEG(1) – (2) (→“JPEG”).

### Note

- When the image capture size is larger than “1280×960” or “1280×720”, the image may become smaller than the actual size depending on the window size of the web browser.

### ⑤ **Stream information display**

Displays the setup for stream encoding format, image capture size, bit rate, and frame rate for the live view of a stream.

#### **Note**

- Displays the values set in the stream. The actual bit rate and frame rate vary depending on the network environment and the used PC.

### ⑥ **[Refresh interval] pull-down menu**

This pull-down menu will be displayed only when a JPEG image is displayed. Use it to select the display method of the JPEG image.

- **MJPEG:** Uses viewer software to display JPEG images successively as MJPEG (Motion JPEG). Not available if the viewer software is not installed.
- **Refresh interval : 1s/Refresh interval : 3s/Refresh interval : 5s/Refresh interval : 10s/Refresh interval : 30s/Refresh interval : 60s:** Refreshes JPEG format (still images) images at the specified interval.

#### **Note**

- Depending on the network environment or the PC used, JPEG format (still images) images may not be refreshed at the specified interval.

### ⑦ **[Zoom] buttons**



Images will be zoomed in on with the electronic zoom by the viewer software “Network Camera View 4S”.

- **[x1] button:** The images in the main area will be displayed at x1.
- **[x2] button:** The images in the main area will be displayed at x2.
- **[x4] button:** The images in the main area will be displayed at x4.

#### **Note**

- When displaying in the JPEG format (still image), the electronic zoom will become inoperable.

### ⑧ **[Brightness] buttons<sup>2</sup>**

The brightness is adjustable from 0 to 255. Click the  button to make the image brighter, or click the  button to make the image darker. If you click the [Normal] button, the display will be reset to default.

### ⑨ **[Rec. on SD] button<sup>2</sup>**

The [Rec. on SD] button will be displayed only when “Manual” is selected for “Save trigger” on the [SD memory card] tab. (→[Save trigger])

Click this button to manually record images on the SD memory card. Refer to “1.3 Record images on the SD memory card manually” for descriptions of how to manually record images on the SD memory card.

### ⑩ **[Log/Play] button**

When the [Log/Play] button is clicked, the log list will be displayed and images saved on the SD memory card can be played.

Refer to “1.5 Display the log list” for further information about the log list and for how to play images on the SD memory card.

### ⑪ **[Viewer software] button**

Starts installation of the viewer software for display. This button will not be available if the viewer software is already installed on the PC, or if the “Automatic installation” of the [Viewer software (nwc4Ssetup.exe)] in the [Basic] tab is set to “Off”. (→[Viewer software (nwc4Ssetup.exe)] - [Automatic installation])

### ⑫ **Camera title**

The camera title entered for “Camera title” on the [Basic] tab will be displayed. (→[Camera title])

### ⑬ **Support button**

When this button is clicked, the support site will be displayed in a newly opened window. This website contains technical information, FAQ, and other information.

### ⑭ **Alarm occurrence indication button<sup>2</sup>**

When an alarm occurs, the display flashes. When this button is clicked, the button will disappear.

**Note**

- Since the blinking of the alarm occurrence indication button is not coupled to recording images to the SD memory card, forwarding E-mails, or other operations, check the settings of each operation separately.

**⑮ Full screen button**

Images will be displayed on a full screen. If the full screen button is clicked once when the image displayed in the main area is smaller than the main area, the image is displayed corresponding to its image capture size. If the full screen button is clicked once when images are displayed corresponding to their image capture sizes, images are displayed in full screen. To return to the “Live” page when displaying an image in full screen, press the [Esc] key on the PC keyboard or select [Back] from the right-click menu displayed when the mouse is right-clicked.

**⑯ Snap shot button**

Click this button to take a picture (a still picture). The picture will be displayed on a newly opened window. When right-clicking on the displayed image, the pop-up menu will be displayed. It is possible to save the image on the PC by selecting “Save” from the displayed pop-up menu. When “Print” is selected, printer output is enabled.

**Note**

- If the viewer software is not installed, “Save” and “Print” will not be displayed in the pop-up menu.
- The following settings may be required.  
Open Internet Explorer, click [Tools] → [Internet Options] → [Security] → [Trusted Sites] → [Sites]. Register the camera address on [Website] of the displayed trusted windows. After registration, close the web browser, and then access the camera again.
- When it takes longer than the specified period to obtain the snap shot picture due to the network environment, the snap shot picture may not be displayed.
- If the image capture size specified for JPEG cannot be obtained, JPEG images are displayed with the image capture size that could be obtained.  
Therefore, when JPEG images obtained with snap shot are displayed on a PC, the displayed image size may differ from the captured sized.

**⑰ SD recording status indicator**

The status of the SD recording can be checked with this indicator.

When the SD recording starts, the SD recording status indicator will light red. It will go off when the SD recording stops.

This indicator will be displayed when “Manual” or “Schedule” is selected for “Save trigger” on the setup menu. (→“2.4.2 Configure the settings relating to the SD memory card [SD memory card]”)

**⑱ Main area**

Images from the camera will be displayed in this area.

The current time and date will be displayed according to the settings configured for “Time display format” and “Date/time display format”. (→“2.4.1 Configure the basic settings [Basic]”)

In addition, when being adjusted, the status of brightness (→[Brightness status display]) will be displayed as well as the characters configured for “Camera title on screen” (→[Camera title on screen]). The number of lines for the display is 2.

A zoom operation can be performed using the mouse wheel.

When clicking a desired point while displaying live images at x2 or x4 in the main area, the camera will move to locate the clicked point at the center of the main area.

**Note**

- When the camera is operated by a user with a low access level, images displayed on the screen may be changed temporarily. This does not affect operation of the camera.
- Depending on the PC in use, screen tearing\* may occur when the shooting scene drastically changes due to the GDI restrictions of the OS.

\*A phenomenon in which portions of the screen are displayed out of alignment.

---

<sup>\*1</sup> Only operable by users whose access level is "1. Administrator".

<sup>\*2</sup> Only operable by users whose access level is "1. Administrator" or "2. Camera control" when "On" is selected for "User auth." (→"2.7.1 Configure the settings relating to the user authentication [User auth.]")

## 1.2 Monitor images on a mobile terminal/tablet device

### 1.2.1 Monitor images on a mobile terminal (including smartphones)

It is possible to connect to the camera using a mobile terminal via the Internet and monitor images (MJPEG or JPEG) from the camera on the screen of the mobile terminal. It is also possible to refresh images to display the latest image.

The compatible mobile terminals are shown as follows. (As of September, 2021)

- iPad, iPhone (iOS 8 or later)
- Android™ mobile terminals

When an Android terminal is used, an MJPEG format image is displayed by the Firefox® browser, and a JPEG format image is displayed by the standard browser.

#### **IMPORTANT**

- When the authentication window is displayed, enter the user name and password.  
To enhance the security, it is recommended to change the password periodically. (→“2.7.1 Configure the settings relating to the user authentication [User auth.]”)

#### **Note**

- It is necessary to configure the network settings of the mobile terminal in advance to connect to the Internet and monitor images from the camera. (→“2.8 Configuring the network settings [Network]”)
1. Access to “http://IP address/cam”<sup>1</sup> or “http://Host name registered in the DDNS server/cam”<sup>2</sup> using a mobile terminal.  
→ Images from the camera will be displayed.

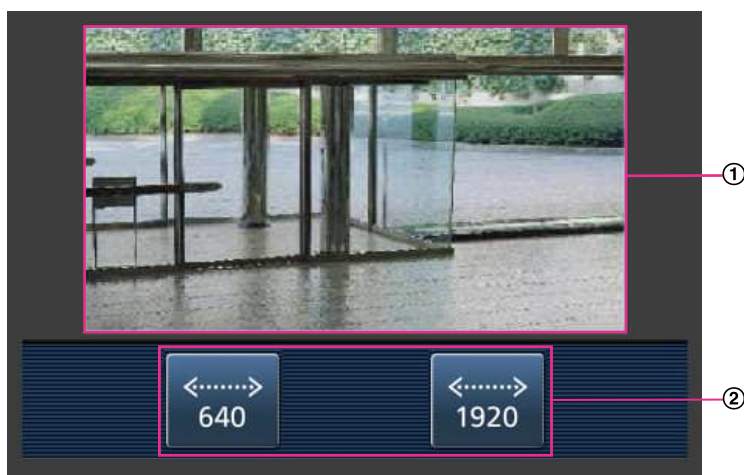

- ① Live images area  
Displays images from the camera.
- ② Operation buttons area  
Buttons to operate functions are displayed.

#### **Note**

- The operations button displayed on the mobile terminal screen may not be available depending on the user rights and access level of the accessing user. To display the operations button, it is

necessary to set the user rights and access level ("User auth." in "User mng."). (→"2.7.1 Configure the settings relating to the user authentication [User auth.]")

2. Click the button of the function that you want to operate.

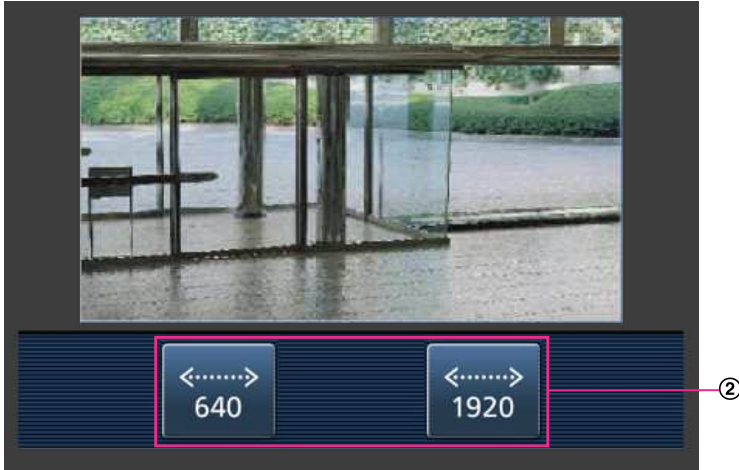

① Resolution control

The resolution can be changed by selecting a resolution setting from the buttons.

Images are displayed in the image capture size selected in "JPEG(1)" or "JPEG(2)" of [JPEG] on the [Image] tab.

However, the images of the image capture size of "2560×1440" **U154x** **U254x** **U114x**

**U214x** cannot be displayed.

### Note

- You can change the image size displayed on the mobile terminal by accessing the following addresses.
  - Large display: `http://IP address/cam/dl`
  - Medium display: `http://IP address/cam/dm`
  - Small display: `http://IP address/cam/ds`
- When the resolution is changed by the resolution control, the displayed resolution changes but the image size remains the same.
- When the HTTP port number is changed from "80", enter "`http://IP address: (colon) + port number/cam`"<sup>1</sup> in the address box of the browser. When using the DDNS function, access to "`http://Host name registered in the DDNS server: (colon) + port number/cam`"<sup>2</sup>.
- When "HTTPS" is selected for "HTTPS" - "Connection" on the [Advanced] tab of the "Network" page, enter as follows.  
"`https://IP address: (colon) + port number/cam`" or "`https://Host name registered in the DDNS server: (colon) + port number/cam`"
- When the authentication window is displayed, enter the user name of an administrator or user and password. Depending on the mobile terminal in use, password entry may be required each time the screen is switched.
- Depending on the mobile terminal in use, larger size images may not be displayed. In this case, selecting a setting close to the lowest quality setting for "Image quality setting" of "JPEG" (→"2.5.2 Configure the settings relating to JPEG images [Image]") may sometimes solve this problem.

- Depending on the mobile terminal in use or its contract plan, it may be impossible to access.

- <sup>\*1</sup> IP address is the global WAN IP address of the router that can be accessed via the Internet. However, when accessing the same LAN as the camera with a wireless compatible mobile terminal, the IP address is the local IP address.
- <sup>\*2</sup> Only when accessing the camera via the Internet.

## 1.2.2 Monitor images on a tablet device

It is possible to connect to the camera using a tablet device via the Internet and monitor images (MJPEG or JPEG) from the camera on the screen of the tablet device. It is also possible to refresh images to display the latest image.

The compatible mobile terminals are shown as follows. (As of September, 2021)

- iPad, iPhone (iOS 8 or later)
- Android™ mobile terminals

When an Android terminal is used, an MJPEG format image is displayed by the Firefox® browser, and a JPEG format image is displayed by the standard browser.

### IMPORTANT

- When the authentication window is displayed, enter the user name and password.  
To enhance the security, it is recommended to change the password periodically. (→“2.7 Configure the settings relating to the authentication [User mng.]”)

### Note

- It is necessary to configure the network settings of the tablet device in advance to connect to the Internet and monitor images from the camera. (→“2.8 Configuring the network settings [Network]”)
  - Depending on the device model, the same screen as the PC may be displayed. In that case, access to “http://IP address/live/tab.html” or “http://Host name registered in the DDNS server/live/tab.html”.
1. Access to “http://IP address/” or “http://Host name registered in the DDNS server/” using a tablet device.  
→ Images from the camera will be displayed.

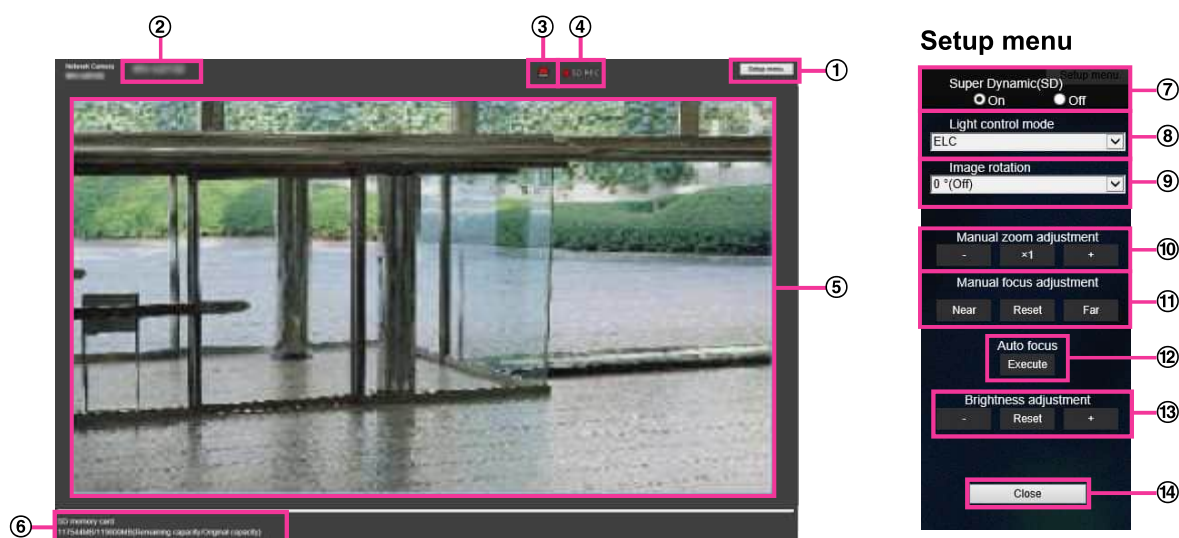

- ① [Setup menu] button<sup>\*1</sup>  
Displays the setup menu.

### ② **Camera title**

The camera title entered for "Camera title" on the [Basic] tab will be displayed. (→[Camera title])

### ③ **Alarm occurrence indication button**<sup>2</sup>

When an alarm occurs, the display flashes. When this button is clicked, this button will disappear. (→"1.4 Action at an alarm occurrence")

#### **Note**

- Since the blinking of the alarm occurrence indication button is not coupled to recording images to the SD memory card, forwarding E-mails, or other operations, check the settings of each operation separately.

### ④ **SD recording status indicator**

The status of the SD recording can be checked with this indicator. When the SD recording starts, the SD recording status indicator will light red. It will go off when the SD recording stops. This indicator will be displayed when "Manual" or "Schedule" is selected for "Save trigger" on the setup menu. (→"2.4.2 Configure the settings relating to the SD memory card [SD memory card]")

### ⑤ **Main area**

The live images from the camera will be displayed in this area.

### ⑥ **Remaining capacity**

Displays the remaining capacity and total capacity of the SD memory card.

### ⑦ **Super Dynamic setting**

Select "On" or "Off" to determine whether or not to activate the super dynamic function. Refer to the description "Super Dynamic function" (→"Super Dynamic(SD)") about the super dynamic function.

**On:** The super dynamic function will work.

**Off:** The super dynamic function will not work.

**Default:** On

#### **Note**

- When the following are observed depending on the light condition, select "Off" for "Super Dynamic(SD)".
  - When flickering appears or the color changes on the screen
  - When noise appears in the brighter area on the screen

### ⑧ **[Light control mode] pull-down menu**

Select the light control mode from the following.

**Indoor scene (50 Hz)/Indoor scene (60 Hz):** The shutter speed will automatically be adjusted to prevent flicker caused by fluorescent light. Select 50 Hz or 60 Hz corresponding to the location where the camera is in use.

**ELC:** Uses shutter speed adjustment to control light.

**Default:** ELC

#### **Note**

- When 25fps mode is selected for [Image capture mode], "Indoor scene (60 Hz)" is not available.

### ⑨ **Image rotation**

Sets whether or not to rotate the image.

**0 °(Off):** Do not rotate the image.

**90 °:** Rotate the image 90 degrees.

**180 °(Upside-down):** Flip the image upside down.

**270 °:** Rotate the image 270 degrees.

**Default:** 0 °(Off)

### **IMPORTANT**

- The position shifts if the image rotation setting is changed when the following area settings are configured. Therefore, configure the settings for each area after configuring the image rotation.
  - Mask area (→"2.5.4.2 Set mask areas")

- Privacy zone (→“2.5.4.5 Configure the settings relating to the privacy zone (“Privacy zone” setup menu”)
- VMD area (→“2.6.4 Set the VMD areas [VMD area]”)
- SCD area (→“2.6.6 Set the SCD areas [SCD area]”)
- VIQS area (→“2.5.4.7 Configure the VIQS area”)
- If “90 °” or “270 °” is selected for [Image rotation], depending on the [Character size] setting and the number of characters used, characters displayed on the screen may be cut off.
- When [Image rotation] is set to “90 °”, “270 °”, the position that can be set in [Date/time position] and [Camera title position] is restricted to “Upper left” and “Lower left”.

**Note**

- When [4:3 mode(30fps mode)] or [4:3 mode(25fps mode)] is selected for [Image capture mode], “90 °” and “270 °” cannot be selected for [Image rotation]. **U153x** **U253x**  
**U113x** **U213x**
- When [Image capture size] of any of JPEG(1), JPEG(2), Stream(1), Stream(2) and Stream(3) is set to “320x180”, “90 °” and “270 °” will become unavailable for [Image rotation].

**⑩ Manual zoom adjustment**

Adjust the zoom manually.

**[-]**: Adjust the zoom (magnification) up to 1.0 time in the “Wide” side.

**[x1]**: Make the zoom (magnification) 1.0 times.

**[+]**: Adjust the zoom (magnification) to the “Tele” side.

**Note**

[WV-U2542LA] [WV-U2532LA] [WV-U1542LA] [WV-U1532LA] [WV-U2142LA] [WV-U2132LA]  
[WV-U1142A] [WV-U1132A]

- The camera switches between optical zoom and extra optical zoom depending on the zoom ratio. The supported optical zoom and extra optical zoom ratios vary depending on the model and the selected image capture mode.
- When “Image capture size” is set to “640x360” or a higher resolution, image quality may deteriorate depending on the zoom ratio. For further information, refer to our website <Control No.: C0124>.

[WV-U2540LA] [WV-U2532LA] [WV-U2140LA] [WV-U2130LA] [WV-U1130A]

- The maximum zoom ratio for extra zoom varies depending on the model and the selected [Image capture mode].
- Refer to the Important Information for more information about the maximum zoom ratio.

**IMPORTANT**

[WV-U2542LA] [WV-U2532LA] [WV-U1542LA] [WV-U1532LA] [WV-U2142LA] [WV-U2132LA]  
[WV-U1142A] [WV-U1132A]

- If extra optical zoom is configured after configuring settings for the mask area, privacy zone, VMD area, SCD area and VIQS area, the configured areas for those settings may move out of alignment. Therefore, perform the setting for extra optical zoom function before other settings.

[WV-U2540LA] [WV-U2532LA] [WV-U2140LA] [WV-U2130LA] [WV-U1130A]

- The extra zoom function may not be activated on the appropriate position if the setting for the function is performed after the settings for the privacy zone, VMD area, SCD area, or VIQS area. Therefore, configure each area's settings after configuring the extra zoom settings.
- Configure mask area settings with a zoom ratio of x1.0. The mask area operates in the mask position of zoom ratio of x1.0 even after extra zoom settings.

**⑪ Manual focus adjustment [WV-U2542LA][WV-U2532LA][WV-U1542LA][WV-U1532LA][WV-U2142LA][WV-U2132LA][WV-U1142A][WV-U1132A]**

Adjust the focus manually.

**[Near]**: Adjust the focus in the “near” direction.

**[Reset]:** Return focus to initial setting.

**[Far]:** Adjust the focus in the “far” direction.

### **Note**

- One-click of the [Near] or [Far] button is a fine adjustment, and it can look like there is no change in the focus. To shift the focus point largely, keep the button pressed.

### ⑫ **Auto focus [WV-U2542LA][WV-U2532LA][WV-U1542LA][WV-U1532LA][WV-U2142LA][WV-U2132LA][WV-U1142A][WV-U1132A]**

**[Excute]:** When you press the button, the auto focus function works and automatically adjusts the focus to the subject in the center area of the screen.

### **IMPORTANT**

- With “16:9 mode(30fps mode)” or “16:9 mode (2688x1520 30fps mode)” selected for “Image capture mode”, if “Auto focus” is executed during slow shutter operation at night while a value longer interval than “Max.1/30s” (Max.2/30s, Max.4/30s, Max.6/30s, Max.10/30s, or Max.16/30s) is selected for “Maximum shutter”, completing auto focus may take a long time.
- With “16:9 mode(25fps mode)” or “16:9 mode (2688x1520 25fps mode)” selected for “Image capture mode”, if “Auto focus” is executed during slow shutter operation at night while a value longer interval than “Max.1/25s” (Max.2/25s, Max.4/25s, Max.6/25s, Max.10/25s, or Max.16/25s) is selected for “Maximum shutter”, completing auto focus may take a long time.
- In the following locations or with the following subjects, the focus may not be able to be automatically adjusted. In this case, manually adjust the focus.
  - when the subject moves a lot
  - when there are large changes to the lighting intensity
  - when the light level is low
  - when the subject or location is extremely bright or reflective
  - when viewing through windows
  - when the dome cover is in a location where it can easily become dirty
  - locations where there is not much contrast such as a white wall
  - when there is harsh flickering
- When images in the near-infrared light area change from color to black & white, images may be out of focus due to the nature of optical properties. In this case, the focus can automatically be corrected by selecting “Auto” or “Preset” for “Adjusting method” (the focus will not automatically be adjusted according to the illumination level change once the focus is corrected).

### ⑬ **[Brightness adjustment] button**

Adjust the brightness.

Click the [+] button to make the image brighter.

Click the [-] button to make the image darker.

Click the [Reset] button to reset to the default brightness setting.

### ⑭ **[Close] button**

Close the setup menu.

### **Note**

- When the HTTP port number is changed from “80”, enter “http://IP address: (colon) + port number”<sup>1</sup> in the address box of the browser. When using the DDNS function, access to “http://Host name registered in the DDNS server: (colon) + port number”<sup>3</sup>.
- When “HTTPS” is selected for “HTTPS” - “Connection” on the [Advanced] tab of the “Network” page, enter as follows.  
“https://IP address: (colon) + port number” or “https://Host name registered in the DDNS server: (colon) + port number”<sup>3</sup>

- When the authentication window is displayed, enter the user name of an administrator or user and password. Depending on the mobile terminal in use, password entry may be required each time the screen is switched.
- Depending on the tablet device in use, larger size images may not be displayed. In this case, selecting a setting close to the lowest quality setting for “Image quality setting” of “JPEG” (→“2.5.2 Configure the settings relating to JPEG images [Image]”) may sometimes solve this problem.
- Depending on the tablet device in use or its contract plan, it may be impossible to access.

---

\*1 Only operable by users whose access level is “1. Administrator”.

\*2 Only operable by users whose access level is “1. Administrator” or “2. Camera control” when “On” is selected for “User auth.” (→[User auth.])

\*3 Only when accessing the camera via the Internet.

## 1.3 Record images on the SD memory card manually

Images displayed on the “Live” page can be recorded on the SD memory card manually. This button is operable only when “Manual” is selected for “Save trigger” on the [SD memory card] tab on the “Basic” page of the setup menu. (→[Save trigger])

It is possible to select “Stream(1)”, “Stream(2)”, or “Stream(3)” on “Recording format” of the setup menu. (→“Recording stream”) When “Stream(1)”, “Stream(2)”, or “Stream(3)” is selected, video data are recorded.

1. Display the “Live” page. (→“1.1.1 Monitor images from a single camera”)

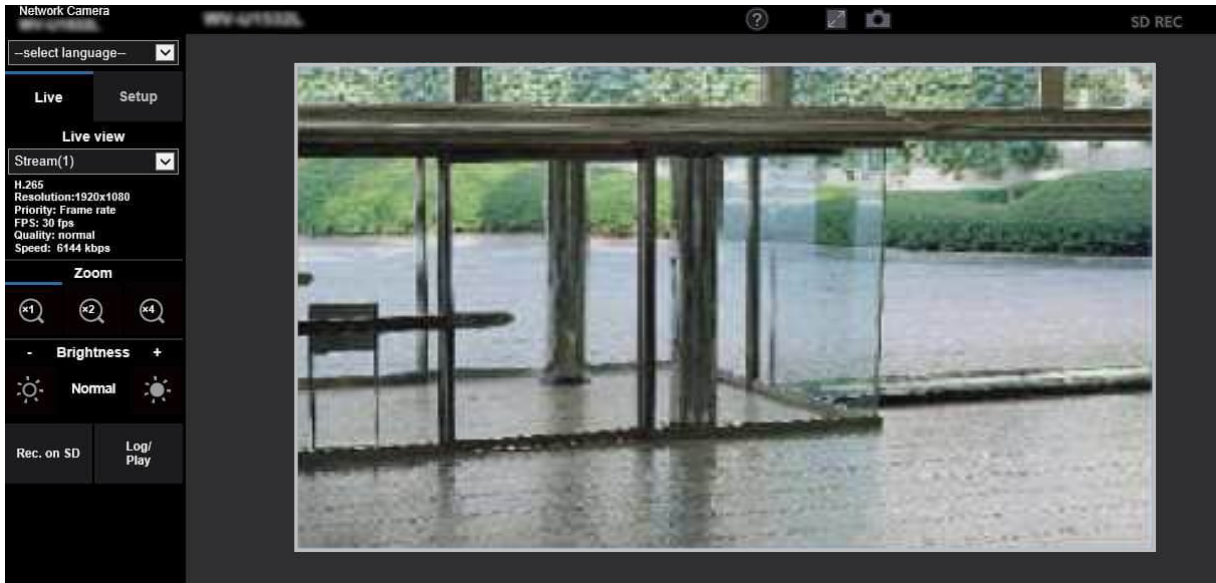

2. Click the [Rec. on SD] button.  
→ The SD recording window will open.

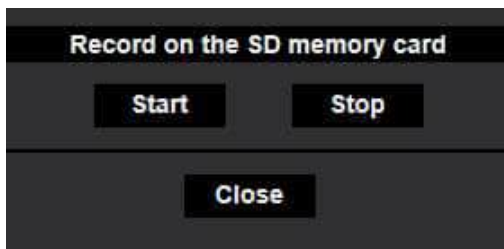

3. Click the [Start] button to start recording images on the SD memory card. The SD recording status indicator will light red (→“1.1.2 About the “Live” page”) while images are being recorded on the SD memory card. The image saving interval can be configured on the [SD memory card] tab of the “Basic” page. (→“2.4.2 Configure the settings relating to the SD memory card [SD memory card]”)
4. Click the [Stop] button to stop saving images on the SD memory card.  
→ The SD recording status indicator will turn off.
5. Click the [Close] button to close the window.

### Note

- When the [Start] button is clicked immediately after the [Stop] button is clicked, saving of images may not start. In this case, click the [Start] button again.

## 1.4 Action at an alarm occurrence

The alarm action (camera action at an alarm occurrence) will be performed when the following alarms occur.

### 1.4.1 Alarm type

- **VMD alarm:** When motion is detected in the set VMD area, the alarm action will be performed.  
\*VMD stands for "Video Motion Detection".
- **SCD alarm:** When scene change is detected in the set SCD\* area, the alarm action will be performed.  
\*SCD stands for "Scene Change Detection".
- **Command alarm:** When a TCP alarm notification is received from the connected device via a network, the alarm action will be performed.

### 1.4.2 Action at an alarm occurrence

#### Display the alarm occurrence indication button on the "Live" page

The alarm occurrence indication button will be displayed on the "Live" page at an alarm occurrence.  
(→"1.1.2 About the "Live" page")

#### **IMPORTANT**

- When "Polling(30s)" is selected for "Status update mode" (→"2.4.1 Configure the basic settings [Basic]"), the Alarm occurrence indication button will be refreshed in 30-second intervals. For this reason, it may take a maximum of 30 seconds until the alarm occurrence indication button is displayed on the "Live" page at an alarm occurrence.

#### Save images on the SD memory card

When an alarm occurs, images (H.265) will be saved on the SD memory card. The settings to save images on the SD memory card can be configured on the [SD memory card] tab (→"2.4.2 Configure the settings relating to the SD memory card [SD memory card]") of the "Basic" page and the [Alarm] tab of the "Alarm" page. (→"2.6.2 Configure the settings relating to the camera action on alarm occurrence [Alarm]")

#### Notify of alarm occurrences by E-mail

Alarm E-mail (alarm occurrence notification) can be sent at an alarm occurrence to the E-mail addresses registered in advance. Up to 4 addresses can be registered as recipients of the alarm E-mail. The settings for alarm E-mail can be configured in the "Alarm E-mail notification" section on the [Alarm] tab of the "Alarm" page (→"2.6.2 Configure the settings relating to the camera action on alarm occurrence [Alarm]") and the [Advanced] tab of the "Network" page (→"2.8.2.1 Configure the settings related to sending E-mails").

#### Notify of alarm occurrences to the designated addresses (TCP alarm notification)

This function is available only when our device, such as the network disk recorder, is connected to the system. When "On" is selected for "TCP alarm notification", the connected our device will be notified that the camera is in the alarm state. The settings for TCP alarm notification can be configured in the "TCP alarm notification" section of the [Notification] tab of the "Alarm" page. (→"2.6.7.1 Configure the settings relating to TCP alarm notification")

### **Notify of alarm occurrences to the designated HTTP server (HTTP alarm notification)**

Alarm occurrence notifications can be sent at an alarm occurrence to the HTTP servers registered in advance. Up to 5 HTTP servers can be registered as recipients of alarm notifications. The URL sent to HTTP servers with alarm notifications can be specified. The settings for HTTP alarm notification can be configured on the [Notification] tab of the “Alarm” page. (→“2.6.7.2 Configure the settings relating to HTTP alarm notification”)

## 1.5 Display the log list

The history of various logs will be displayed in list form.

- **Alarm log:** Logs of the alarm occurrences such as time and date of the alarm occurrences, the image recording period and the alarm type will be displayed.
- **Manual/Schedule log:** Logs filed when images have been recorded manually or during the period of the schedule, and the image recording period will be displayed.

1. Display the “Live” page.

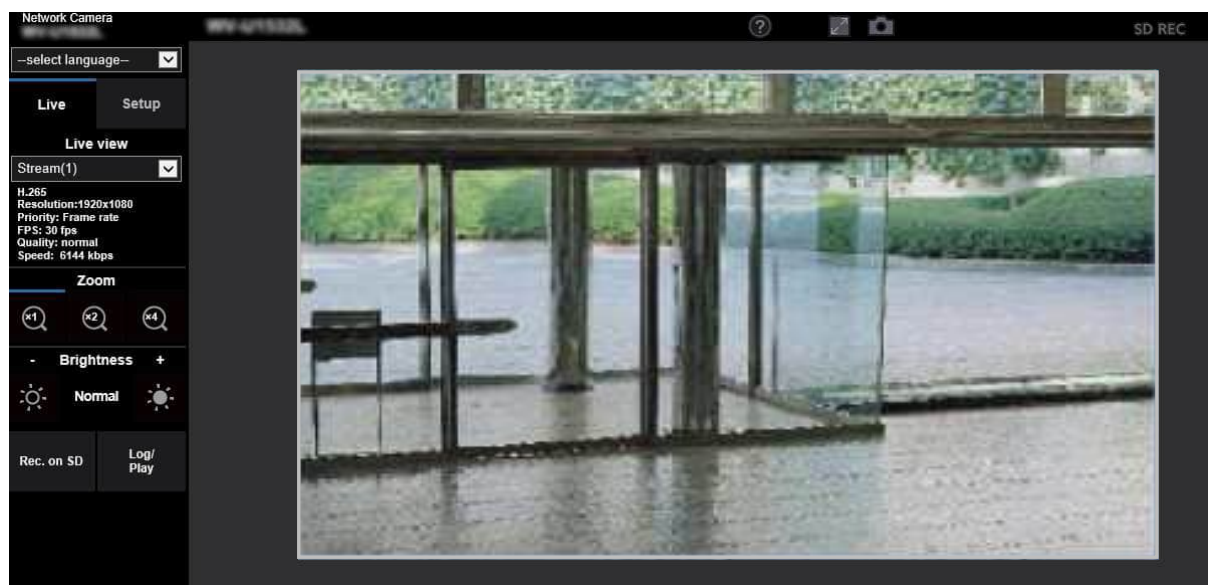



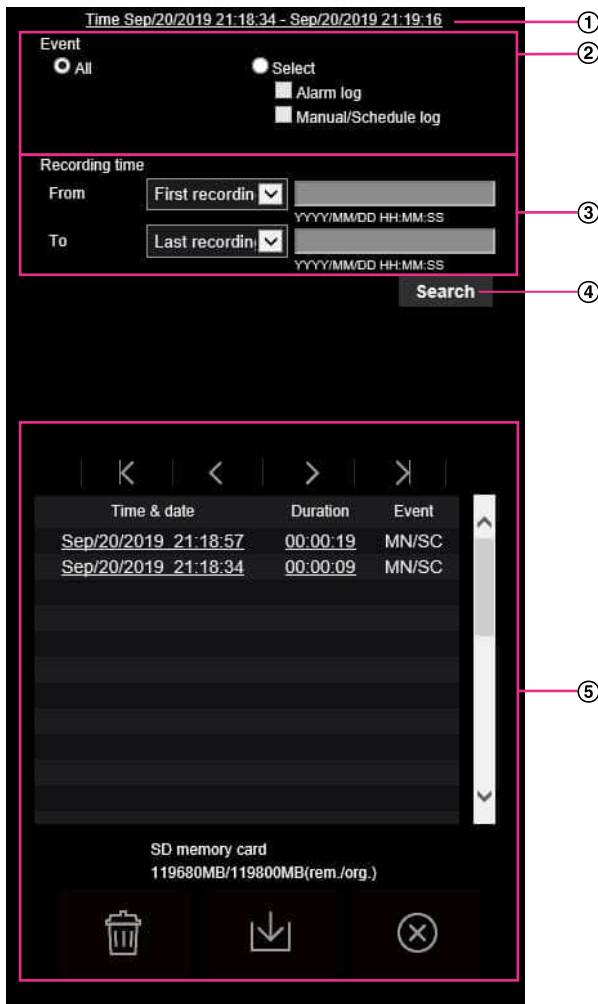

2. Click the [Log/Play] button.  
 → The log list will be displayed in a newly opened window (log list window).



**IMPORTANT**

- Only a single user can operate the log list window. Other users cannot access the log list window.

- ① **Time**  
Displays the time period of the data recorded on the SD memory card.
- ② **Event**  
Select a log type to display on the log list.
  - **All**: All logs will be displayed.
  - **Select**: Only the logs of the selected log type will be displayed.
    - **Alarm log**: The log when an alarm is detected will be displayed.
    - **Manual/Schedule log**: Manual and Schedule logs will be displayed.
  - **Default**: All
- ③ **Recording time**  
Configure the time period of logs displayed on the log list.
  - **From**: Configure the starting period of logs displayed on the log list.
    - **First recording**: Displays from the first log recorded on the SD memory card.
    - **Today**: Displays the logs recorded today.
    - **Yesterday**: Displays the logs recorded from yesterday to the present day.



- **Last 7 days:** Displays the logs recorded from 6 days ago to the present day.
- **Last 30 days:** Displays the logs recorded from 29 days ago to the present day.
- **Date/time:** Displays the logs recorded from the entered date and time on “Date/time” box.
- **To:** Configure the ending period of logs displayed on the log list when “First recording” or “Date/time” is selected for “From”.
  - **Last recording:** Displays until the last log recorded on the SD memory card.
  - **Date/time:** Displays the logs recorded until the entered date and time on “Date/time” box.
- ④ **[Search] button**  
Searches for logs according to the conditions specified in “Event” and “Recording time”.  
The search result will be displayed on the log list.
- ⑤ **Log list**  
Displays the log search results.  
You can play back recorded data by clicking on the time or duration of the recorded data displayed under [Time & date] and [Duration].
  -  **(Top) button:** Click this button to display the log listed at the top.
  -  **(Prev. page) button:** Click this button to display the previous page of the log list.
  -  **(Next page) button:** Click this button to display the next page of the log list.
  -  **(Last) button:** Click this button to display the log listed at the bottom.
  - **[Time & date]:** Time and date when each log has been recorded will be displayed.

**Note**

- When “Off” is selected for “Time display format”, the alarm occurrence times are displayed in 24 hour time format.
- The recording timing of logs is as follows.
  - **Alarm log:** Alarm occurrence time and date will be filed as a log.
  - **Manual/Schedule log:** Time and date when recording onto the SD memory card started manually or by schedule settings will be filed as a log. When images are recorded sequentially, logs will be filed every hour from the time when recording starts.
- **[Duration]:** Displays the period of time that the data has been recorded on the SD memory card.
- **[Event]:** The event type will be displayed.
  - **MN/SC:** Log by “Manual/Schedule”
  - **VMD:** Alarm by VMD alarm
  - **SCD:** Alarm by SCD alarm
  - **COM:** Alarm by command alarm
- **[SD memory card]:** Available capacity and the original capacity of the SD memory card will be displayed.
-  **(Delete) button:** Deletes log lists from all pages. When logs are searched for, only the searched logs are deleted. Images associated with deleted logs will also be deleted.

**IMPORTANT**

- If there are many recorded data files on the SD memory card, it may take time to delete all of them. (For example, when the total size is 1 GB, it may take about 1 hour to delete the files.) In this case, format the SD memory card. However, please note that formatting will delete all of the files on the SD memory card.
- In the process of the deletion, “Alarm” and “Manual/Schedule” cannot be operated.

- Do not turn off the power of the camera until the deletion is complete. When the power of the camera is turned off in the process of the deletion, some images may remain on the SD memory card. In this case, click the  button on the same log list window used to delete the logs.
-  **(Download) button:** Click this button to download all logs of the selected log list onto the PC.

### **Note**

- The following settings may be required.  
Open Internet Explorer, click [Tools] → [Internet Options] → [Security] → [Trusted Sites] → [Sites]. Register the camera address on [Website] of the displayed trusted windows.  
After registration, close the web browser, and then access the camera again.
- Up to 50,000 logs will be downloaded to the SD memory card. When more than 50,000 logs are filed, the older logs will be overwritten by the newer logs. In this case, the oldest log is the first to be overwritten.  
If there are many logs, it may take time to download the logs.
-  **(Close) button:** Click this button to close the log list window.

## 1.6 Playback of images on the SD memory card

When clicking a time and date listed on the log list window, the “Live” page will turn to the “Playback” page. When images associated with the clicked time and date are on the SD memory card, the first image of them will be displayed.

### **IMPORTANT**

- Refresh interval of images may become slow during playback or download.
- When many images are saved on the SD memory card, it may take time to display images on the “Playback” page.
- When the aspect ratio is “4:3”, images will be displayed in VGA size on the “Playback” page regardless of the image capture size of the images saved on the SD memory card. When the aspect ratio is “16:9”, images will be displayed in “640×360” on the “Playback” page regardless of the image capture size of the images saved on the SD memory card. Therefore, images may look coarse on the “Playback” page.
- The playback refresh interval may become slower when recording data to the SD memory card.

### 1.6.1 Playback “Stream(1)”/“Stream(2)”/“Stream(3)” images saved to the SD memory card

#### **IMPORTANT**

- Depending on the network environment, download of video data may fail. If downloading failed while playing images, you may be able to download images after stopping the currently played images and starting the download again.
- Depending on the network environment and status of the camera, you may not be able to operate each operation on this screen consecutively.



### ① Slider bar

By operating the slider bar, you can select where to start playing images from. The slider bar can only be used before playing images, or when playing is paused or stopped.

### (PAUSE) button

Playback will be paused when this button is clicked during playback.

### (PLAY) button

When this button is clicked, recorded data will be played.

### (FF) button

Each time this button is clicked, the playback speed will change. When the  button is clicked during fast playback, playback speed will return to the normal playback speed.

### **Note**

- The maximum speed of the fast playback varies depending on the setting of “Bit rate” - “Stream recording” of the SD memory card.

### (5s backward) button

Each time this button is clicked, the recorded data goes back by 5 seconds and starts playing.

### (5s forward) button

Each time this button is clicked, the recorded data goes forward by 5 seconds and starts playing.

### (STOP) button

Playback will stop and the “Playback” window will turn to the “Live” page.

### **[Time & date]**

Time and date when each log has been recorded will be displayed.

### **[Duration]**

Displays the period of time that the data has been recorded on the SD memory card.

### **[Event]**

The event type will be displayed.

- **MN/SC:** Log by “Manual/Schedule”
- **VMD:** Alarm by VMD alarm
- **SCD:** Alarm by SCD alarm
- **COM:** Alarm by command alarm

### (Start) button

The selected image will be downloaded onto the PC.

Before downloading images, designate the destination directory in advance. (→“2.4.3 Configure the directory of the PC that images will be downloaded to [Log]”)

The message window will be displayed to ask if it is OK to start download when the  button is clicked. Click the [OK] button.

**Note**

- The image playing screen cannot be operated while downloading. Perform operations after the downloading is completed.
- When the [Cancel] button is clicked in the process of the download, the download will be canceled. In this case, video data already downloaded before clicking the [Cancel] button will be saved on the PC.
- Video data are saved in the files of approx. 20 MB. When the file size of video data is more than 20 MB, two or more files will be downloaded.
- For information on playing back H.265 video data, refer to the following our website below.  
[https://i-pro.com/global/en/surveillance/training\\_support/support/technical\\_information](https://i-pro.com/global/en/surveillance/training_support/support/technical_information) <Control No.: C0303>

## 2 Settings

### 2.1 About the network security

#### 2.1.1 Equipped security functions

The following security functions are featured in this camera.

- ① Access restrictions by the host authentication and the user authentication  
It is possible to restrict users from accessing the camera by setting the host authentication and/or the user authentication to “On”. (→“2.7.1 Configure the settings relating to the user authentication [User auth.]”, “2.7.2 Configure the settings relating to the host authentication [Host auth.]”)
- ② Access restrictions by changing the HTTP port  
It is possible to prevent illegal access such as port scanning, etc. by changing the HTTP port number. (→“Common”)
- ③ Access encryption by the HTTPS function  
It is possible to enhance the network security by encrypting the access to cameras using the HTTPS function. (→“2.8.2.4 Configure the HTTPS settings”)

#### **IMPORTANT**

- Design and enhance security countermeasures to prevent leakage of information such as image data, authentication information (user name and password), alarm E-mail information, DDNS server information, etc. Perform the countermeasure such as access restriction (using the user authentication) or access encryption (using the HTTPS function).
- After the camera is accessed by the administrator, make sure to close the browser for added security.
- Change the administrator password periodically for added security.
- When using the SNMP function with SNMPv1/v2, do not set a community name that can easily be guessed. (Example: public)  
Use of an easily guessable community name may result in leakage of status information of this product on the network or being used as a stepping stone for illegal access to other devices.

#### **Note**

- When user authentication (authentication error) has failed to pass 8 times within 30 seconds using the same IP address (PC), access to the camera will be denied for a while.

## 2.2 Display the setup menu from a PC

The settings of the camera can be configured on the setup menu.

### IMPORTANT

- The setup menu is only operable by users whose access level is “1. Administrator”. Refer to “2.7.1 Configure the settings relating to the user authentication [User auth.]” for how to configure the access level.

### 2.2.1 How to display the setup menu

1. Display the “Live” page. (→“1.1.1 Monitor images from a single camera”)
2. Click the [Setup] button on the “Live” page.  
→ The setup menu will be displayed. Refer to “2.2.3 About the setup menu window” for further information about this menu.

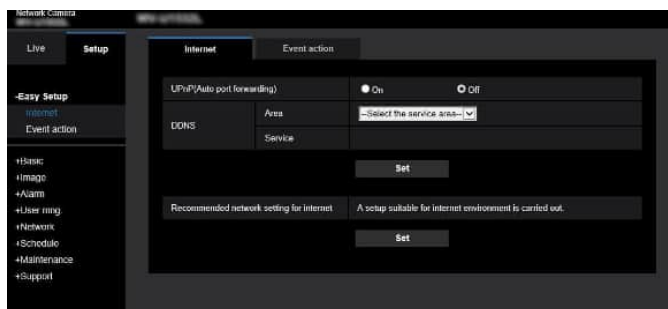

### 2.2.2 How to operate the setup menu

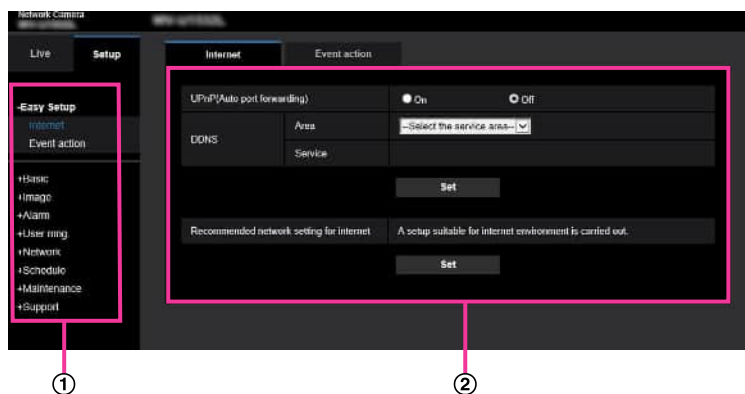

- ① Menu buttons
- ② Setup page

1. Click the desired button in the frame on the left of the window to display the respective setup menu. When there are tabs at the top of the “Setup” page displayed in the frame on the right of the window, click the desired tab to display and configure the setting items relating to the name of the tab.
2. Complete each setting item displayed in the frame on the right of the window.
3. After completing each setting item, click the [Set] button to apply them.

### IMPORTANT

- When there are two or more [Set], [Register], and [Execute] buttons on the page, click the respective button to the edited setting item.

#### <Example>

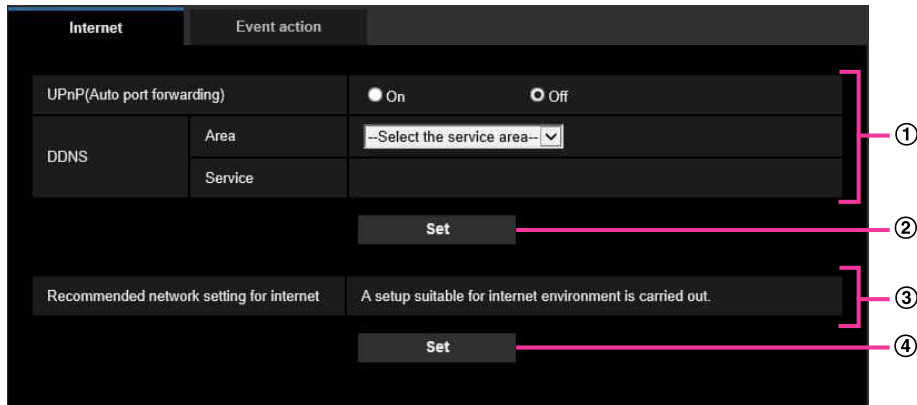

When completing the setting items in field ①, click the [Set] button ② below field ①.  
The edited settings in field ① will not be applied unless the [Set] button ② below field ① is clicked.  
In the same manner as above, click the [Set] button ④ below field ③ when completing the setting items in field ③.

## 2.2.3 About the setup menu window

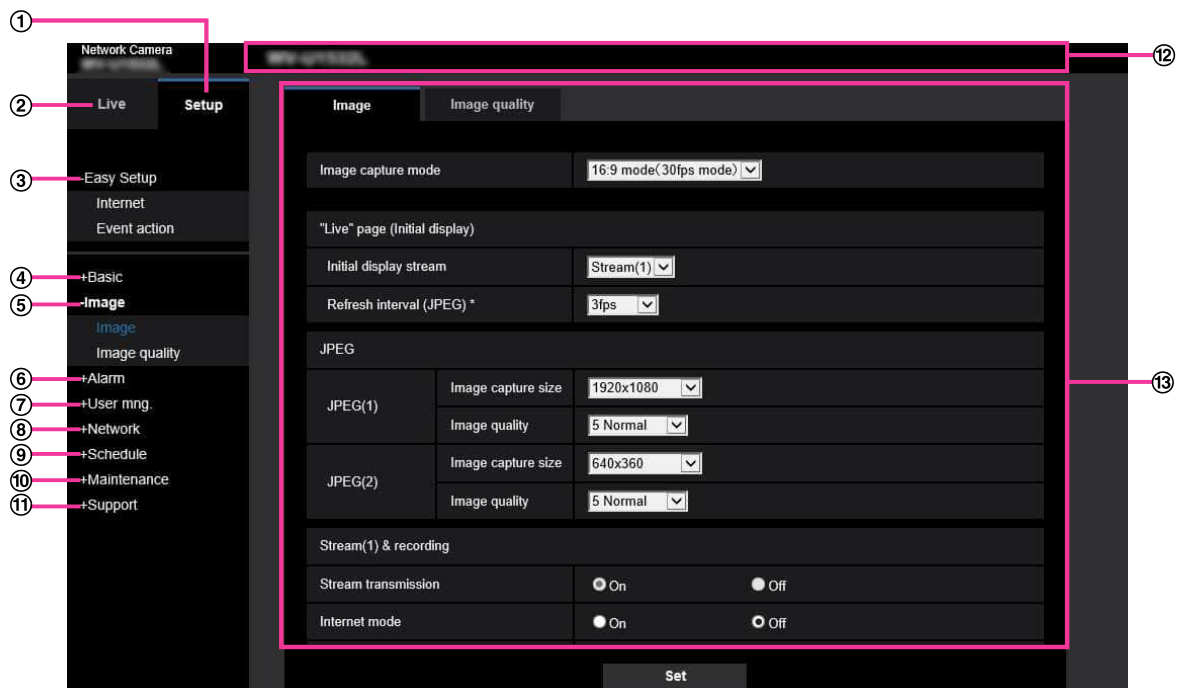

- ① **[Setup] button**  
Display the “Setup” page.
- ② **[Live] button**  
Display the “Live” page.
- ③ **[Easy Setup] button**  
Displays the “Easy Setup” page. The “Easy Setup” page is used to set the connectivity to the Internet, as well as to set event actions such as alarm settings and camera action on alarm. (→“2.3 Use Easy Setup [Easy Setup]”)
- ④ **[Basic] button**  
Displays the “Basic” page. The basic settings such as time and date and camera title, and the settings relating to the SD memory card can be configured on the “Basic” page. (→“2.4 Configure the basic settings of the camera [Basic]”)
- ⑤ **[Image] button**  
Displays the “Image” page. The settings relating to image quality, image capture size, etc. of JPEG/H.265/H.264 camera images can be configured on the “Image” page. (→“2.5 Configure the settings relating to images [Image]”)
- ⑥ **[Alarm] button**  
Displays the “Alarm” page. The settings relating to alarm occurrences such as settings for the alarm action at an alarm occurrence, the alarm occurrence notification, the VMD area settings and the SCD area settings can be configured on the “Alarm” page. (→“2.6 Configure the alarm settings [Alarm]”)
- ⑦ **[User mng.] button**  
Displays the “User mng.” page. The settings relating to the authentication such as users and PC restrictions for accessing the camera can be configured on the “User mng.” page. (→“2.7 Configure the settings relating to the authentication [User mng.]”)

- ⑧ **[Network] button**  
Displays the “Network” page. The network settings and the settings relating to DDNS (Dynamic DNS), SNMP (Simple Network Management Protocol), the NTP server, and QoS can be configured on the “Network” page. (→“2.8 Configuring the network settings [Network]”)
- ⑨ **[Schedule] button**  
Displays the “Schedule” page. On the “Schedule” page, it is possible to designate time zones to allow to activate the VMD function and the SCD function. (→“2.9 Configure the settings relating to the schedules [Schedule]”)
- ⑩ **[Maintenance] button**  
Displays the “Maintenance” page. System log check, firmware upgrade, status check and initialization of the setup menu can be carried out on the “Maintenance” page. (→“2.10 Maintenance of the camera [Maintenance]”)
- ⑪ **[Support] button**  
Displays the “Support” page. The “Support” page contains methods to display our support website. (→“2.11 Display our support website [Support]”)
- ⑫ **Camera title**  
The title of the camera whose settings are currently being configured will be displayed.
- ⑬ **Setup page**  
Pages of each setup menu will be displayed. There are tabs for some setup menus.  
The bottom of the settings page has been omitted.

## 2.3 Use Easy Setup [Easy Setup]

The “Easy Setup” page uses simple operations to set the following:

- Make the camera image available on the Internet
- Set event actions such as recording of a schedule/alarm to the SD memory card

The “Easy Setup” page consists of the [Internet] tab and [Event action] tab.

### 2.3.1 Configure the Internet settings [Internet]

Click the [Internet] tab of the “Easy Setup” page. (→For menu display and how to operate, refer to “2.2.1 How to display the setup menu”, “2.2.2 How to operate the setup menu”)

The settings relating to UPnP (Auto port forwarding), DDNS (Viewnetcam.com), and network settings for the Internet can be configured on this page.



#### [UPnP (Auto port forwarding)]

Select “On” or “Off” to determine whether or not to use the port forwarding function of the router.

To use the auto port forwarding function, the router in use must support UPnP and the UPnP must be enabled.

- **Default:** Off

#### Note

- Due to auto port forwarding, the port number may sometimes be changed. When the number is changed, it is necessary to change the port numbers registered in the PC and recorders, etc.
- The UPnP function is available when the camera is connected to the IPv4 network. IPv6 is not supported.
- To check if auto port forwarding is properly configured, click the [Status] tab on the “Maintenance” page, and check that the “Enable” is displayed for “Status” of “UPnP”. (→“2.10.3 Check the status [Status]”)
 

When “Enable” is not displayed, refer to “Cannot access the camera via the Internet.” in “3.2 Troubleshooting”.
- When the “UPnP (Auto port forwarding)” setting is changed, the “Auto port forwarding” setting under “UPnP” on the [Advanced] tab of the “Network” page also changes to the same setting.

#### [Area]

Select the region where the camera is installed.

Global/Japan

### Note

- If the camera is used in Japan, select “Japan”. If the camera is used outside of Japan, select “Global”. The “Viewnetcam.com” service that is displayed when “Global” is selected cannot be used in Japan.

### [Service]

Select “Viewnetcam.com” or “Off” to determine whether or not to use “Viewnetcam.com”. After configuring “Viewnetcam.com”, click “Go to Viewnetcam.com Registration page” to display the registration window for “Viewnetcam.com” in a newly opened window. Follow the on-screen instructions to register with “Viewnetcam.com”. Refer to “2.8.6.1 When using the “Viewnetcam.com” service” or the “Viewnetcam.com” website (<http://www.viewnetcam.com/>) for further information.

- **Default:** Off

### Note

- When the “DDNS” setting is changed, the “DDNS” setting on the [Advanced] tab of the “Network” page also changes to the same setting.

### [Recommended network setting for internet]

The recommended settings for connecting to the Internet are performed here. By clicking the [Set] button, a dialog displaying how the following settings will change is displayed. Click the [OK] button after checking the settings to change the settings to the displayed values.

- [Image] tab on the “Image” page

#### [JPEG(1)]

[Image capture size]: VGA/640x360

#### [JPEG(2)]

[Image capture size]: QVGA/320x180

#### [Stream(1)]/[Stream(2)]/[Stream(3)]

[Internet mode]: On

[Transmission priority]: Best effort

[Max bit rate (per client)\*]: 1024 kbps

#### [Stream(1)]

[Image capture size]: 1280x960/1280x720  U153x  U253x  U113x  U213x

[Image capture size]: 1920x1080  U154x  U254x  U114x  U214x

#### [Stream(2)]

[Image capture size]: VGA/640x360

#### [Stream(3)]

[Image capture size]: QVGA/320x180

- [Network] tab on the “Network” page

#### [Common]

[Max RTP packet size]: Limited(1280byte)

[HTTP max segment size(MSS)]: Limited(1280byte)

## 2.3.2 Configure an event action [Event action]

Click the [Event action] tab in the “Easy Setup” page. (→For menu display and how to operate, refer to “2.2.1 How to display the setup menu”, “2.2.2 How to operate the setup menu”)

The current settings are displayed here.

The screenshot shows a settings interface with two tabs: 'Internet' and 'Event action'. The 'Event action' tab is active. Below the tabs, there is a section titled '[Current settings]'. This section contains two tables. The first table, titled 'Alarm', has three rows: 'Alarm condition' with value 'Off', 'Alarm' with value 'Off', and 'E-mail notification' with value 'Off'. The second table, titled 'Schedule', has one row: 'Schedule' with value 'Off'. Below the tables, there is a '[Notes]' section with a single bullet point: '• When the operating condition is changed, some settings will be cancelled. Confirm the settings after completing the setup.' At the bottom center of the screen is a 'Next' button.

You can set event actions for SD schedule recording/alarm detection. Once the settings are completed in each setup menu, click the [Next] button to proceed. The setup flow is as follows.

#### **Note**

- If you click the [Next] button, the settings in the screen will be saved.

## Flow of event action setup

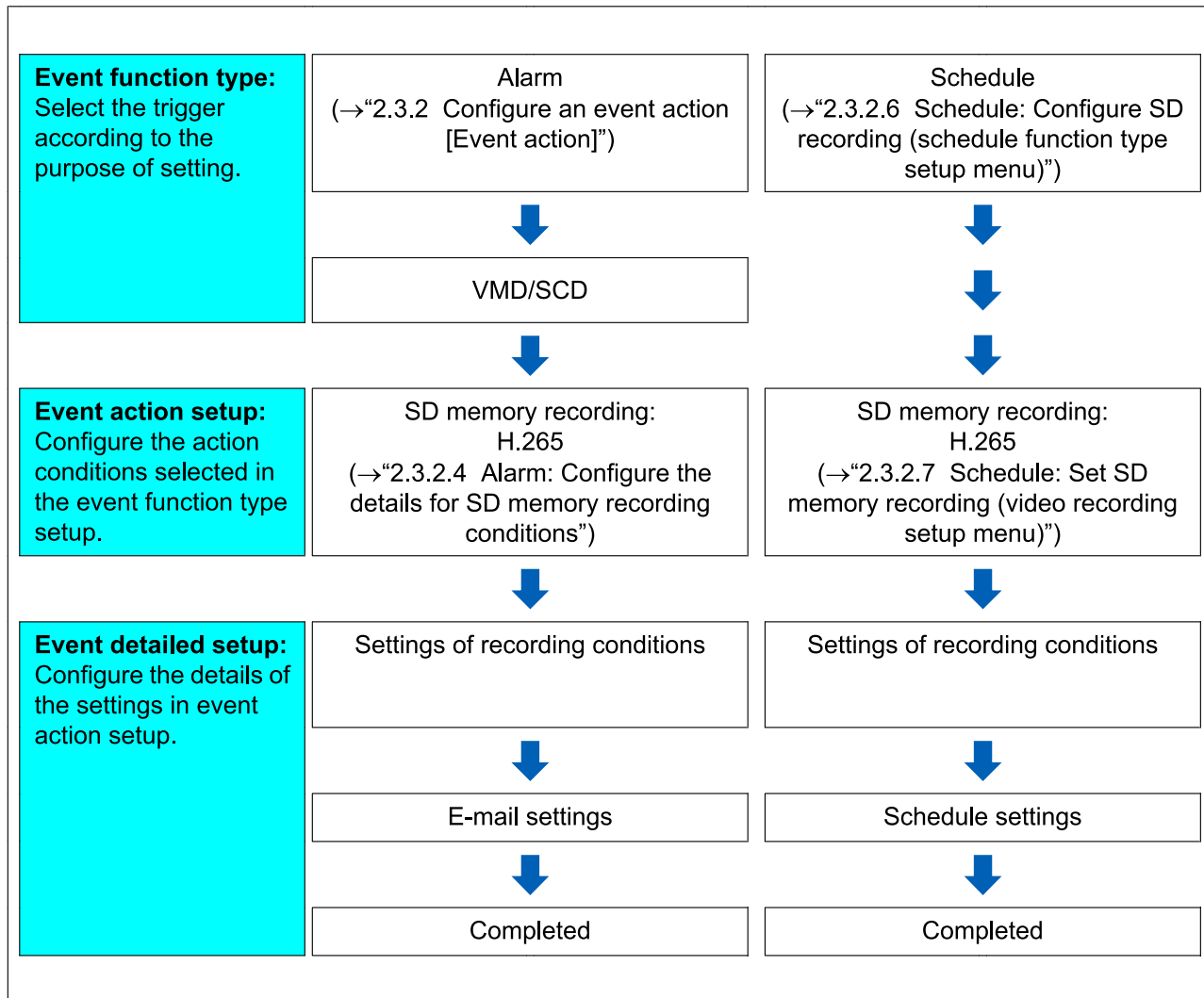

### 2.3.2.1 Configure the schedule/alarm (event function type setup menu)

Here, select the function type of the event.

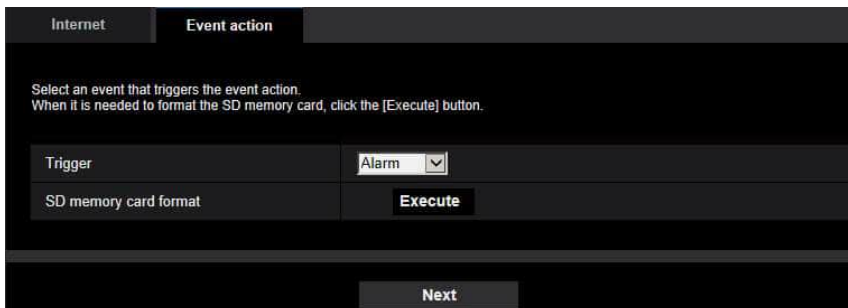

#### [Trigger]

- **Alarm:** Select when setting the alarm detection settings.
- **Schedule:** Select during “SD memory recording”.

- **Default:** Alarm

### [SD memory card format]

To format the SD memory card, click the [Execute] button.

Once you click the [Execute] button, the “Format” confirmation screen will be displayed.

If you click the [OK] button, the formatting will start.

Once the “Format” completion screen is displayed, press the  button.

### IMPORTANT

- All data saved on the SD memory card will be deleted when the SD memory card is formatted.
- Do not turn off the power of the camera during formatting.

### [Next] button

If you select “Alarm”, and click the [Next] button, the alarm setup menu will be displayed. (→“2.3.2.2 Alarm: Configure the VMD and the SCD (alarm setup menu)”)

If you select “Schedule”, and click the [Next] button, the schedule function type setup menu will be displayed. (→“2.3.2.6 Schedule: Configure SD recording (schedule function type setup menu)”)

## 2.3.2.2 Alarm: Configure the VMD and the SCD (alarm setup menu)

The settings relating to actions when an alarm is detected can be configured in this section.

Alarm	
VMD alarm	<input checked="" type="radio"/> On <input type="radio"/> Off
SCD alarm	<input checked="" type="radio"/> On <input type="radio"/> Off
Alarm deactivation time	<input type="text" value="5"/> s (5-600s)
<input type="button" value="Next"/> <input type="button" value="Back"/>	

## Alarm

### [VMD alarm]

- **On:** If the VMD area is not configured, the entire region is configured. To configure the VMD area, use the [VMD area] tab on the “Alarm” page. (→“2.6.4 Set the VMD areas [VMD area]”)  
To set the period for when VMD will be used, set the schedule for VMD permission. (→“2.9 Configure the settings relating to the schedules [Schedule]”)  
If the period is not set, VMD will be continuously active.
- **Off:** Disables all VMD states.
- **Default:** Off

### [SCD alarm]

- **On:** Enables the SCD function. To configure the SCD area, use the [SCD alarm] tab on the “Alarm” page. (→“2.6.5 Configure the SCD settings [SCD area]”)  
To set the period for when SCD will be used, set the schedule for SCD permission. (→“2.9 Configure the settings relating to the schedules [Schedule]”)  
If the period is not set, SCD will be continuously active.
- **Off:** Disables the SCD function.
- **Default:** Off

### [Alarm deactivation time]

Set the duration for which detection is not to be performed after an alarm has been detected. For example, by using this function you can prevent mail from being sent too often when the E-mail notifications are configured to be sent to cellular phones when an alarm is detected.

5 – 600 seconds

- **Default:** 5s

#### Note

- The duration of the alarm deactivation time can be specified for each type of alarm. For example, during the time when detections for VMD alarm are not made, detections for command alarms can be made.

### [Next] button

If you click the [Next] button, the alarm function type setup menu will be displayed. (→“2.3.2.3 Alarm: Configure the alarm function type (Alarm function type setup menu)”)

#### Note

- If you click the [Next] button, the setting items in the screen are saved.

### [Back] button

If you click the [Back] button, the event function type setup menu will be displayed. (→“2.3.2.1 Configure the schedule/alarm (event function type setup menu)”)

## 2.3.2.3 Alarm: Configure the alarm function type (Alarm function type setup menu)

The recording format of SD memory recording when an alarm occurs can be selected on this section.



### [Trigger]

- **SD memory recording:** When an alarm occurs, records the image to the SD memory card.

### [Recording format]

“Stream(1)”, “Stream(2)”, or “Stream(3)” can be selected for the recorded image.

### [Next] button

If you click the [Next] button, the video recording setup menu will be displayed. (→“2.3.2.7 Schedule: Set SD memory recording (video recording setup menu)”)

#### Note

- If you click the [Next] button, the setting items in the screen are saved.

### [Back] button

If you click the [Back] button the alarm setup menu will be displayed. (→“2.3.2.2 Alarm: Configure the VMD and the SCD (alarm setup menu)”)

## 2.3.2.4 Alarm: Configure the details for SD memory recording conditions

The SD memory recording when an alarm is detected is configured in this section.

Stream recording(Alarm)	
Frame rate*	30fps * ▾
Pre alarm (recording) duration	Off ▾
Post alarm (recording) duration	30s ▾
<input type="button" value="Next"/> <input type="button" value="Back"/>	

### [Frame rate]

Select a frame rate for the H.265 to be recorded.

#### Note

- Refer to [Frame rate\*] in “2.3.2.7 Schedule: Set SD memory recording (video recording setup menu)” for information about available frame rates and the bit rates that are set according to the frame rate.

### [Pre alarm (recording) duration]

Determine whether or not to perform the pre alarm recording. Set the duration to save image data on the SD memory card.

Off/ 1s/ 2s/ 3s/ 4s/ 5s/ 8s/ 10s/ 15s/ 20s/ 25s/ 30s/ 40s/ 50s/ 60s/ 90s/ 120s

- Default:** Off

#### Note

- The values change depending on the bit rate and the image capture size of the recorded stream. As the selected bit rate increases, the available maximum value for the pre alarm duration decreases.

### [Post alarm (recording) duration]

Set the duration to save image data on the SD memory card after an alarm occurrence.

10s/ 20s/ 30s/ 40s/ 50s/ 60s/ 120s/ 180s/ 240s/ 300s

- Default:** 30s

\* The actual recording time may sometimes be longer than the duration selected for this setting.

### [Next] button

If you click the [Next] button, the mail setup menu will be displayed. (→“2.3.2.5 Alarm: configure the mail notifications and mail server”)

#### Note

- If you click the [Next] button, the setting items in the screen are saved.

### [Back] button

If you click the [Back] button, the alarm function type setup menu will be displayed. (→“2.3.2.3 Alarm: Configure the alarm function type (Alarm function type setup menu)”)

## 2.3.2.5 Alarm: configure the mail notifications and mail server

The settings relating to e-mail can be configured in this section.

## 2 Settings

- To configure e-mail related settings:

E-mail notification

E-mail notification  On  Off

SMTP server address  Example of entry: 192.168.0.10

SMTP port  (1-65535)

POP server address  Example of entry: 192.168.0.10

Authentication

Type  None  POP before SMTP  SMTP

User name

Password

Sender's E-mail address

SSL  On  Off

Destination of notification

Destination E-mail address

Address 1  Delete  VMD  SCD

Address 2  Delete  VMD  SCD

Address 3  Delete  VMD  SCD

Address 4  Delete  VMD  SCD

E-mail subject(Alarm)  Use the camera title  Cause of alarm

E-mail subject(Diag.)  Use the camera title

E-mail body  Cause of alarm  Occurrence time

The %p% alarm was occurred at %t%.

Set Back

Refer to “2.8.2.1 Configure the settings related to sending E-mails” for information about how to configure the above screen.

### [Set] button

If you click the [Set] button, setup will be completed.

### [Back] button

If you click the [Back] button, the video recording setup menu (→“2.3.2.7 Schedule: Set SD memory recording (video recording setup menu)”) will be displayed.

### 2.3.2.6 Schedule: Configure SD recording (schedule function type setup menu)

The recording format for scheduled SD memory recording can be selected on this section.



#### [Trigger]

- **SD memory recording:** Records the H.265 image in the SD memory card at the scheduled time.

#### [Recording format]

“Stream(1)”, “Stream(2)”, or “Stream(3)” can be selected for the recorded image.

#### [Next] button

If you click the [Next] button, the video recording setup menu will be displayed. (→“2.3.2.7 Schedule: Set SD memory recording (video recording setup menu)”)

#### Note

- If you click the [Next] button, the setting items in the screen are saved.

#### [Back] button

If you click the [Back] button, the event function type setup menu will be displayed. (→“2.3.2.1 Configure the schedule/alarm (event function type setup menu)”)

### 2.3.2.7 Schedule: Set SD memory recording (video recording setup menu)

Here, SD memory recording is configured according to the schedule.

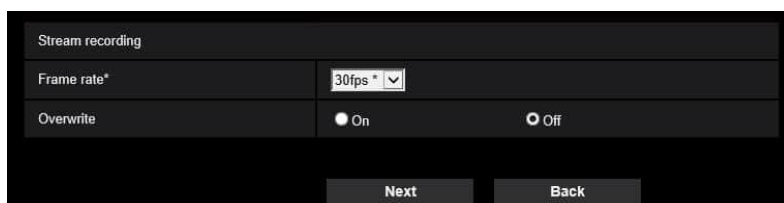

#### [Frame rate\*]

Select a frame rate for the H.265 to be recorded from the following.

- When 30fps mode is selected for [Image capture mode]:  
1fps/ 3fps/ 5fps\*/ 7.5fps\*/ 10fps\*/ 12fps\*/ 15fps\*/ 20fps\*/ 30fps\*
- When 25fps mode is selected for [Image capture mode]:  
1fps/ 3.1fps/ 4.2fps\*/ 6.25fps\*/ 8.3fps\*/ 12.5fps\*/ 20fps\*/ 25fps\*

**Default:** 30fps\*

## 2 Settings

### Note

- If you click the [Next] button, the “Transmission priority” will be set to “Frame rate”. (→[Transmission priority])

The bit rate is set as follows depending on the selected image capture size and frame rate.  
Unit: kbps

When [16:9 mode(30fps mode)] or [16:9 mode (2688x1520 30fps mode)] is selected for [Image capture mode]:

Image capture size	Frame rate (fps)							
	1	3	5	7.5	10	12	20	30
320×180	128	256	256	256	256	256	256	384
640×360	256	384	384	384	384	384	384	512
1280×720	384	512	512	512	768	768	768	1024
1920×1080	768	1024	1024	1024	1536	1536	1536	2048
2560×1440 U154x U254x U114x U214x	1280	1536	1536	1792	2560	2560	3072	3072

When [4:3 mode(30fps mode)] is selected for [Image capture mode] U153x U253x U113x U213x :

Image capture size	Frame rate (fps)							
	1	3	5	7.5	10	12	20	30
QVGA	128	256	256	256	256	256	256	384
VGA	256	384	384	384	384	384	384	512
1280×960	512	768	768	768	768	1024	1024	1024
1600×1200	768	1024	1024	1024	1536	1536	1536	2048

When [16:9 mode(25fps mode)] or [16:9 mode (2688x1520 25fps mode)] is selected for [Image capture mode]:

Image capture size	Frame rate (fps)							
	1	2	4.2	6.25	8.3	12.5	20	25
320×180	128	256	256	256	256	256	256	384
640×360	256	384	384	384	384	384	384	512
1280×720	384	512	512	512	768	768	1024	1536
1920×1080	768	1024	1024	1024	1536	1536	2048	2048

Image capture size	Frame rate (fps)							
	1	2	4.2	6.25	8.3	12.5	20	25
<b>2560×1440</b> <input type="checkbox"/> U154x <input type="radio"/> U254x <input checked="" type="checkbox"/> U114x <input type="radio"/> U214x	1280	1536	1536	1792	2560	2560	3072	3072

When [4:3 mode(25fps mode)] is selected for [Image capture mode]  U153x  U253x  U113x  U213x :

Image capture size	Frame rate (fps)							
	1	2	4.2	6.25	8.3	12.5	20	25
<b>QVGA</b>	128	256	256	256	256	256	256	384
<b>VGA</b>	256	384	384	384	384	384	384	512
<b>1280×960</b>	512	768	768	768	768	1024	1024	1536
<b>1600×1200</b>	768	1024	1024	1024	1536	1536	2048	2048

### [Overwrite]

Determine whether or not to overwrite images when the remaining capacity of the SD memory card becomes insufficient.

- **On:** Overwrites when the remaining capacity of the SD memory card becomes insufficient. (The oldest image is the first to be overwritten.)
- **Off:** Stops saving images on the SD memory card when the SD memory card becomes full.
- **Default:** Off

### **IMPORTANT**

- When the [Overwrite] setting is changed from “Off” to “On”, if the remaining capacity of the SD memory card is low, old images may be deleted in order to prepare to save new images.

### [Next] button

If you click the [Next] button, the setup menu to set the schedule for recording into the SD memory card will be displayed. (→“To configure the schedule settings.”)

### [Back] button

If you click the [Back] button, the schedule function type setup menu will be displayed. (→“2.3.2.6 Schedule: Configure SD recording (schedule function type setup menu)”)

## 2 Settings

- To configure the schedule settings:

Schedules	
Schedule 1 (White)	Schedule mode VMD permission
	Time range <input checked="" type="checkbox"/> Mon <input checked="" type="checkbox"/> Tue <input checked="" type="checkbox"/> Wed <input checked="" type="checkbox"/> Thu <input checked="" type="checkbox"/> Fri <input checked="" type="checkbox"/> Sat <input checked="" type="checkbox"/> Sun 24h 09:00 - 17:00
Schedule 2 (Blue)	Schedule mode VMD permission
	Time range <input checked="" type="checkbox"/> Mon <input checked="" type="checkbox"/> Tue <input type="checkbox"/> Wed <input checked="" type="checkbox"/> Thu <input checked="" type="checkbox"/> Fri <input checked="" type="checkbox"/> Sat <input type="checkbox"/> Sun 24h 23:00 - 07:00
Schedule 3 (Green)	Schedule mode SCD permission
	Time range <input checked="" type="checkbox"/> Mon <input checked="" type="checkbox"/> Tue <input checked="" type="checkbox"/> Wed <input checked="" type="checkbox"/> Thu <input checked="" type="checkbox"/> Fri <input checked="" type="checkbox"/> Sat <input checked="" type="checkbox"/> Sun 24h 00:00 - 00:00
Schedule 4 (Red)	Schedule mode Off
	Time range <input type="checkbox"/> Mon <input type="checkbox"/> Tue <input type="checkbox"/> Wed <input type="checkbox"/> Thu <input type="checkbox"/> Fri <input type="checkbox"/> Sat <input type="checkbox"/> Sun 24h 00:00 - 00:00
Schedule 5 (Black)	Schedule mode Off
	Time range <input type="checkbox"/> Mon <input type="checkbox"/> Tue <input type="checkbox"/> Wed <input type="checkbox"/> Thu <input type="checkbox"/> Fri <input type="checkbox"/> Sat <input type="checkbox"/> Sun 24h 00:00 - 00:00

**Set**      **Back**

Refer to “2.9 Configure the settings relating to the schedules [Schedule]” for information about how to set the above screen.

### [Set] button

If you click the [Set] button, setup will be completed.

### [Back] button

If you click the [Back] button, the (video recording setup menu will be displayed. (→“2.3.2.7 Schedule: Set SD memory recording (video recording setup menu)”))

### Note

- Video recording is not performed if “SD memory recording” is not selected in the “Schedule mode”.

## 2.4 Configure the basic settings of the camera [Basic]

The basic settings such as camera title, time and date, SD memory card and the logs can be configured on the “Basic” page. The “Basic” page has the [Basic] tab, the [SD memory card] tab, and the [Log] tab.

### 2.4.1 Configure the basic settings [Basic]

Click the [Basic] tab on the “Basic” page. (→For menu display and how to operate, refer to “2.2.1 How to display the setup menu”, “2.2.2 How to operate the setup menu”)

## 2 Settings

The settings such as the camera title, time and date, etc. can be configured on this page.

Basic		SD memory card	Log
Menu language		Auto	
Camera title			
Time & date	Date/time	Oct 01 2019 12:45:48 <input type="checkbox"/> Set PC time to the camera	
	Date/time display	<input checked="" type="radio"/> On <input type="radio"/> Off	
	Time display format	24h	
	Date/time display format	Mmm/DD/YYYY	
	Date/time position	Upper left	
	NTP	NTP >>	
	Time zone	(GMT+09:00) Osaka, Sapporo, Tokyo	
	Summer time (daylight saving)	Out	
	Start time & date	Month Day Time	
	End time & date	Month Day Time	
Camera title on screen display		<input checked="" type="radio"/> On <input type="radio"/> Off	
Camera title on screen			
Camera title position		Upper left	
OSD	Character size	100%	
Brightness status display		<input checked="" type="radio"/> On <input type="radio"/> Off	
Image rotation		0°(Off)	
Indicator		<input checked="" type="radio"/> On <input type="radio"/> Off	
Status update mode		<input checked="" type="radio"/> Polling(30s) <input type="radio"/> Real time	
Status reception port		31004 (1-65535)	
Viewer software (nvcv5Ssetup.exe)	Automatic installation	<input checked="" type="radio"/> On <input type="radio"/> Off	
	Drawing method	<input checked="" type="radio"/> GDI <input type="radio"/> Direct2D	
	Decoding Options	<input checked="" type="radio"/> Software <input type="radio"/> Hardware <span>Confirm</span>	
	Smoother live video display on the browser (buffering)	<input checked="" type="radio"/> On <input type="radio"/> Off	
	Frame Skip Options (When PC is Heavy Processing Load)	<input checked="" type="radio"/> Auto <input type="radio"/> Manual	
	Contrast enhancement (RGB:0 to 255)	<input checked="" type="radio"/> On <input type="radio"/> Off	
	Download	<span>Execute</span>	
<span>Set</span>			

### [Menu language]

Select the language to initially display when the camera is accessed from the following.  
Auto/English/Japanese/Italian/French/German/Spanish/Chinese/Russian/Portuguese

- **Auto:** The language used by the browser is automatically selected. If the language used by the browser is not supported by the camera, English is selected.
- **Default:** Auto

The language displayed on the “Live” page can also be changed. (→“1.1.2 About the “Live” page”)

**[Camera title]**

Enter the title of the camera. Click the [Set] button after entering the title of the camera. The entered title will be displayed in the "Camera title" field.

- **Available number of characters:** 0 - 20 characters
- **Unavailable characters:** " &
- **Default:** The model No. is displayed.

**[Date/time]**

Enter the current time and date. When "12h" is selected for "Time display format", "AM" or "PM" can be selected. Check the "Set PC time to the camera" checkbox and click the [Set] button. The date and time of the PC are obtained and set to the camera.

- **Available range:** Jan/01/2013 00:00:00 - Dec/31/2035 23:59:59

**IMPORTANT**

- Use an NTP server when the more accurate time & date setting is required for the system operation. (→"2.8.2.2 Configure the settings relating to the NTP server")

**[Date/time display]**

Select On/Off to determine whether or not to display the date and time on an image. To hide the date and time, select "Off".

- **Default:** On

**[Time display format]**

Select the time display format from "24h" and "12h". Enter the current hour reflecting this setting when entering the current time and date for "Date/time".

- **Default:** 24h

**[Date/time display format]**

Select a date/time display format. When "2019/10/01 13:10:00" is set for "Date/time" after selecting "24h" for "Time display format", time & date will be respectively displayed as follows.

- **DD/MM/YYYY:** 01/10/2021 13:10:00
- **MM/DD/YYYY:** 10/01/2021 13:10:00
- **DD/Mmm/YYYY:** 01/Oct/2021 13:10:00
- **YYYY/MM/DD:** 2021/10/01 13:10:00
- **Mmm/DD/YYYY:** Oct/01/2021 13:10:00
- **Default:** Mmm/DD/YYYY

**[Date/time position]**

Select the position to display the time and date in an image.

- **Upper left:** The information will be displayed at the upper left corner of the screen.
- **Lower left:** The information will be displayed at the lower left corner of the screen.
- **Upper center:** The information will be displayed at the upper center of the screen.
- **Lower center:** The information will be displayed at the lower center of the screen.
- **Upper right:** The information will be displayed at the upper right corner of the screen.
- **Lower right:** The information will be displayed at the lower right corner of the screen.
- **Default:** Upper left

**Note**

- When [Image rotation] is set to "90 °" or "270 °", only "Upper left" or "Lower left" can be selected for [Date/time position].

### [NTP]

When “NTP >>” is clicked, the [Advanced] tab of the “Network” page will be displayed. (→“2.8.2.2 Configure the settings relating to the NTP server”)

### [Time zone]

Select a time zone corresponding to the location where the camera is in use.

- **Default:** (GMT +09:00) Osaka, Sapporo, Tokyo

### [Summer time (daylight saving)]

Select “In”, “Out” or “Auto” to determine whether or not to apply daylight saving time. Configure this setting if the summer time (daylight saving time) is applied in the location where the camera is in use.

- **In:** Applies summer time. An asterisk (\*) will be displayed on the left side of the displayed time and date on the “Live” page.
- **Out:** Does not apply summer time.
- **Auto:** Applies summer time in accordance with the settings for “Start time & date” and “End time & date” (month, week, day of the week, time).
- **Default:** Out

### [Start time & date] [End time & date]

When “Auto” is selected for “Summer time (daylight saving)”, select the time & date for the start time and the end time (month, week, day of the week, time).

### [Camera title on screen display]

Select “On” or “Off” to determine whether or not to display the camera title on the screen. When “On” is selected, the character string entered for “Camera title on screen” will be displayed at the position selected for “Camera title position”.

- **Default:** Off

### [Camera title on screen]

Enter a character string to be displayed on the image.

- **Available number of characters:** 0 - 20 characters
- **Available characters:** 0-9, A-Z, a-z and the following marks.  
! " # \$ % & ' ( ) \* + , - . / : ; = ?
- **Default:** None (blank)

### [Camera title position]

Select the position where the camera title will be displayed on the image.

- **Upper left:** The above information will be displayed at the upper left corner of the main area on the “Live” page.
- **Lower left:** The above information will be displayed at the lower left corner of the main area on the “Live” page.
- **Upper center:** The above information will be displayed at the upper center of the image.
- **Lower center:** The above information will be displayed at the lower center of the image.
- **Upper right:** The above information will be displayed at the upper right corner of the main area on the “Live” page.
- **Lower right:** The above information will be displayed at the lower right corner of the main area on the “Live” page.
- **Default:** Upper left

### Note

- When [Image rotation] is set to “90 °” or “270 °”, only “Upper left” or “Lower left” can be selected for [Camera title position].

**[OSD] - [Character size]**

Select the character size of the date and time as well as text displayed in the image.

- **100%**: Displays in the standard size.
- **150%**: Displays in 150% of the standard size.
- **200%**: Displays in 200% of the standard size.
- **Default**: 100%

**IMPORTANT**

- If the settings for [Date/time position] and [Camera title position] are different, the frame rate may be lower than the specified value.
- If the settings for [Date/time position] and [Camera title position] are different, characters may be displayed incorrectly or overlapped depending on the [Character size] setting and the number of characters used. After completing the settings, confirm the result on the “Live” page.
- If “150%” or “200%” is selected for [Character size], the frame rate may be lower than the specified value.
- Depending on the setting and the numbers of characters used for [Character size], and the setting and image capture size of images, characters displayed on the screen may be cut off. After completing the settings, confirm the result on the “Live” page.

**[Brightness status display]**

Select “On” or “Off” to determine whether or not to display the status of brightness on images displayed on the “Live” page when adjusting brightness.

- **Default**: On

**[Image rotation]**

Set whether or not to rotate the image (JPEG, H.265, H264).

- **0 °(Off)**: Does not rotate the image.
- **90 °**: Rotates the image by 90 degrees.
- **180 °(Upside-down)**: Turns the image upside down.
- **270 °**: Rotates the image by 270 degrees.
- **Default**: 0 °(Off)

**IMPORTANT**

- The position shifts if the image rotation setting is changed when the following area settings are configured. Therefore, configure the settings for each area after configuring the image rotation.
  - Privacy zone (→“2.5.4.5 Configure the settings relating to the privacy zone (“Privacy zone” setup menu)”)
  - VMD area (→“2.6.2.4 Configure settings relating to HTTP alarm notification when an alarm occurs”)
  - SCD area (→“2.6.5 Configure the SCD settings [SCD area]”)
  - VIQS area (→“2.5.4.6 Configure the VIQS setting”)
  - Mask area (→“2.5.4.2 Set mask areas”)
- If “90 °” or “270 °” is selected for “Image rotation”, depending on the “Character size” setting and the number of characters used, characters displayed on the screen may be cut off.
- When “90 °” or “270 °” is selected for “Image rotation”, the position selectable with “Date/time position” and “Camera title position” is limited to “Upper left” or “Lower left”.

**Note**

- When “16:9 mode (2688x1520 30fps mode)” or “16:9 mode (2688x1520 25fps mode)” is selected for [Image capture mode], “90 °” and “270 °” will become unavailable to select. **U154x** **U254x**

**U114x** **U214x**

- When “4:3 mode(30fps mode)” or “4:3 mode(25fps mode)” is selected for “Image capture mode”, “90 °” and “270 °” are not available.  U153x  U253x  U113x  U213x
- When [Image capture size] of any of JPEG(1), JPEG(2), Stream(1), Stream(2) and Stream(3) is set to “320x180”, “90 °” and “270 °” will become unavailable for [Image rotation].
- When the following settings for Stream(1) are set simultaneously, [Image rotation] cannot be set to “90 °” or “270 °”.  U154x  U254x  U114x  U214x
  - [Image capture size]: 2560x1440
  - [Frame rate\*]: “20fps\*” or more
  - [GOP control]: On(Advanced)

### [Indicator]

Determine whether or not to use the following indicators. Select “On” to use the following indicators to check the operational status by lighting them.

- Link indicator (LINK)
- Access indicator (ACT)
- **Default:** On

### Note

- **Link indicator (LINK) (orange):** This indicator will light when communication with the connected device is available.
- **Access indicator (ACT) (green):** This indicator will blink when accessing a network.

### [Status update mode]

Select an interval of the camera status notification from the following.

When the status of the camera changes, the alarm occurrence indication button or the “SD recording status indicator” will be displayed in the “Live” page to notify of the camera status.

- **Polling(30s):** Updates the status each 30 seconds and provide notification of the camera status.
- **Real time:** Provide notification of the camera status when the status has changed.
- **Default:** Real time

### Note

- Depending on the network environment, notification may not be provided in real time.
- When multiple cameras are using the same “Status reception port”, even if “Real time” is selected for “Status update mode”, status notification is not provided in real time. In this case, change the “Status reception port” settings.

### [Status reception port]

When selecting “Real time” for “Status update mode”, designate a port number to which the status change notification is to be sent.

- **Available port number:** 1 - 65535
- **Default:** 31004

The following port numbers are unavailable since they are already in use.

20, 21, 23, 25, 42, 53, 67, 68, 69, 80, 110, 123, 161, 162, 443, 995, 10669, 10670

### [Viewer software (nwcV4Ssetup.exe)] - [Automatic installation]

Determine whether or not to directly install the viewer software from this camera.

- **On:** Installs the viewer software from the camera automatically.
- **Off:** The viewer software cannot be installed from the camera.
- **Default:** On

### Note

- When “Off” is selected for “Automatic installation”, the [Viewer software] button will not be displayed.

**IMPORTANT**

- For PCs that do not have the viewer software “Network Camera View 4S” installed, JPEG images are displayed. You cannot display images using H.265/H.264 from the camera. In order to display H.265/H.264 images from the camera, you must click “Viewer Software” on the “Live” page (→“1.1.2 About the “Live” page”) and then install the viewer software.
- The number of the viewer software installations can be checked on the [Upgrade] tab of the “Maintenance” page.

**[Viewer software (nwcV4Ssetup.exe)] - [Drawing method]**

Perform image display settings when displaying camera images with the viewer software.

- **GDI:** The drawing method generally used in Windows.
- **Direct2D:** Can reduce choppy drawing of images.
- **Default:** GDI

**IMPORTANT**

- Use “Direct2D” with a computer that has the latest graphic driver version installed to it.
- When using “Direct2D”, set “Smoother live video display on the browser (buffering)” to “On”. If “Off” is selected for “Smoother live video display on the browser (buffering)”, “Direct2D” may not be very effective.

**Note**

- When “Direct2D” is selected for “Drawing method”, video may not be displayed or the displayed image may be seen as it is partially corrupted depending on the PC in use.
- Refer to our support website <Control No.: C0313> for information of PCs for which “Direct2D” is selectable.

**[Viewer software (nwcV4Ssetup.exe)] - [Decoding Options]**

Select the decoding method for H.265/H.264 images on the “Live” page.

- **Software:** Decoding is performed by software.
- **Hardware:** Uses the Hardware Acceleration (Intel® Quick Sync Video) function that performs fast decoding.
- **Default:** Software

**IMPORTANT**

- “Hardware” may not be able to be used depending on the computer used. One of the following messages is displayed when the [Confirm] button is clicked.
  - The hardware decode is available for both H.265 and H.264 on your PC.
    - \* Depending on your PC environment, images may not be able to be outputted. In this case, select “Software” for “Decoding Options”.
  - The hardware decode is available for H.264 on your PC, but unavailable for H.265.
    - \* Depending on your PC environment, images may not be able to be outputted. In this case, select “Software” for “Decoding Options”.
  - “The hardware decode is not available on your PC.”
    - Select “Software” for “Decoding Options”.

**Note**

- When “Hardware” is selected for “Decoding Options”, video may not be displayed or the displayed image may be seen as it is partially corrupted depending on the PC in use.
- Refer to our support website <Control No.: C0313> for information of PCs for which “Hardware” is selectable.

### **[Viewer software (nwcV4Ssetup.exe)] - [Smoother live video display on the browser (buffering)]**

Perform settings to display camera images on the viewer software.

- **On:** Images are temporarily stored on the computer and are displayed smoother.
- **Off:** Images are displayed in real-time and are not stored on the computer.
- **Default:** Off

### **[Viewer software (nwcV4Ssetup.exe)] - [Frame Skip Options (When PC is Heavy Processing Load)]**

Perform settings to display camera images on the viewer software.

- **Auto:** If there is a delay in displaying images from the camera, the delay can be resolved by automatically skipping frames.
- **Manual:** If there is a delay in displaying images from the camera, frames are not skipped automatically.
- **Default:** Auto

#### **Note**

- When "Manual" is selected, "Off", "1 Frame Skip", "2 Frames Skip", "4 Frames Skip", "6 Frames Skip", or "8 Frames Skip" can be selected for frame skip by right-clicking on the "Live" page. The value selected here will revert to "Off" when the browser is closed.

### **[Viewer software (nwcV4Ssetup.exe)] - [Contrast enhancement(RGB:0 to 255)]**

Select "On" or "Off" to determine whether or not to enhance the contrast of H.265/H.264 images on the "Live" page.

If "On" is selected, the range of RGB signal on display is extended from 16-235 to 0-255.

When there is a bright part in an image, the intensity may be overexposed. Select a setting suitable to your usage environment.

- **Default:** Off

#### **Note**

- This setting is only available when viewing images on the "Live" page with Internet Explorer.
- Even if this setting is changed, transmitted image data and data saved on the SD memory card are not changed.

### **[Viewer software (nwcV4Ssetup.exe)] - [Download]**

Click the [Execute] button to download the viewer software with the installer to a PC. Follow the on-screen instructions and install the software by executing the downloaded file.

## 2.4.2 Configure the settings relating to the SD memory card [SD memory card]

Click the [SD memory card] tab on the “Basic” page. (→For menu display and how to operate, refer to “2.2.1 How to display the setup menu”, “2.2.2 How to operate the setup menu”)

The settings relating to the SD memory card can be configured on this page.

### Operating mode

#### [SD memory card]

Select “Use” or “Not use” to determine whether or not to use the SD memory card.

- **Default:** Use

#### [Remaining capacity notification]

When the E-mail notification function or the TCP alarm notification function is used to provide notification of the remaining capacity of the SD memory card, select a level to be notified at from the following.

50%/ 20%/ 10%/ 5%/ 2%

- **Default:** 50%

#### Note

- Notification will be provided each time the remaining capacity goes below each of the specified values. For example, notification will be provided each time the remaining capacity reaches 50%, 20%, 10%, 5% and 2% when “50%” is selected. Notification may not always be made at the very moment when the remaining capacity of the SD memory card has reached each value.
- When “On” is selected for “Overwrite”, this setting is gray-out and not available.

#### [Overwrite]

Determine whether or not to overwrite when the remaining capacity of the SD memory card becomes insufficient.

- **On:** Overwrites when the remaining capacity of the SD memory card becomes insufficient. (The oldest image is the first to be overwritten.)
- **Off:** Stops saving images on the SD memory card when the SD memory card becomes full.
- **Default:** Off

### **IMPORTANT**

- Select “Not use” when operating without an SD memory card.
- Before removing the SD memory card from the camera, it is necessary to select “Not use” first. The recorded data may be corrupted if the SD memory card is removed when “Use” is selected.
- When an SD memory card is inserted when “Use” is selected, data will be saved in accordance with the setting of “Save trigger”.
- After inserting the SD memory card, it is necessary to select “Use” to use the SD memory card.
- When the image refresh interval is short, notification/recording timing or interval may become incorrect. Notification/recording may also not be performed correctly as configured when multiple users are receiving images. In this case, set the refresh interval longer.
- There are limited times to overwrite on an SD memory card. When having a high frequency of overwriting, the lifetime of the SD memory card may become shorter.
- A lifetime of an SD memory card should be influenced by the number of the image files stored and log savings on the SD memory card.
- If the data writing speed goes down after data is repeatedly written on an SD memory card, we recommend replacing the SD memory card.
- When the setting is changed from “Off” to “On”, if the remaining capacity of the SD memory card is low, old images may be deleted in order to prepare to save new images.

## Recording stream

### **[Recording format]**

Select the type of image data to be recorded on the SD memory card.

- **Off:** Does not record data.
- **Stream(1):** Records video data (Stream(1)) in the MP4 video encoding format. The data is recorded in accordance with the settings of “Stream(1)” on the [Image] tab of the “Image” page.
- **Stream(2):** Records video data (Stream(2)) in the MP4 video encoding format. The data is recorded in accordance with the settings of “Stream(2)” on the [Image] tab of the “Image” page.
- **Stream(3):** Records video data (Stream(3)) in the MP4 video encoding format. The data is recorded in accordance with the settings of “Stream(3)” on the [Image] tab of the “Image” page.
- **Default:** Off

### **IMPORTANT**

- If an SD memory card with an SD Speed Class other than 10 is used, set the bit rate of a stream selected in “Recording format” to 6 Mbps.
- If an SD memory card with an SD Speed Class 10 is used, set the bit rate of a stream selected in “Recording format” to 12 Mbps.
- When recording streams, the available range of bit rates differs depending on the image capture mode of the stream. Check “Max bit rate (per client)” on the [Image] tab. (→“2.5.3 Configure the settings relating to Stream [Image]”)
- For SD memory cards with an SD Speed Class 10, use a card that supports UHS-I. (Ultra High Speed-I)

### **Note**

- When “Stream(1)” is selected, the settings for “Stream(1)” on the [Image] tab of the “Image” page will be changed to the settings for “Stream(1) & recording”.

When “Stream(2)” is selected, the settings for “Stream(2)” on the [Image] tab of the “Image” page will be changed to the settings for “Stream(2) & recording”.

When “Stream(3)” is selected, the settings for “Stream(3)” on the [Image] tab of the “Image” page will be changed to the settings for “Stream(3) & recording”.

- When “Stream(1)”, “Stream(2)”, or “Stream(3)” is selected for “Recording format”, the settings of the following functions may be corrected.
  - When “VBR” is selected for “Transmission priority”, “Frame rate” is set.
  - When “2s”, “3s”, “4s” or “5s” is selected for “Refresh interval”, “1s” is set.
- The name of the saved file will be given automatically.
- When “Stream(1)”, “Stream(2)”, or “Stream(3)” is selected for “Recording format”, the number of users that can access the camera may be reduced.
- When performing a recording of a stream with a high bit rate on the SD memory card, there may be cases where live image of the same stream cannot be displayed.  
When it is necessary to display the live images of the stream, improve by performing either of the following.
  - Lower the bit rate of the stream being recorded on the SD memory card.
  - Monitor live images of other stream or JPEG live images.

### [Save trigger]

Select a trigger to save images on the SD memory card from the following.

- **Alarm input:** Saves images at an alarm occurrence.
- **Manual:** Saves images manually.
- **Schedule:** Saves images in accordance with the settings for “Schedule” (→“2.9 Configure the settings relating to the schedules [Schedule]”). Available only for the “Stream(1)”, “Stream(2)”, or “Stream(3)” images.
- **Default:** Manual

If you have selected “Alarm input” in the [Save trigger], you can select the alarm type from the following:

- **VMD:** Save the image when motion detection occurs.
- **SCD:** Save the image when SCD occurs.
- **Command alarm:** Save the image when a command alarm is entered.

### Note

- To enable alarms to occur, alarm settings must be configured in advance on the [Alarm] tab.

## Stream recording(Alarm)

Stream recording(Alarm)	
Pre alarm (recording) duration	Off ▼
Post alarm (recording) duration	30s ▼

This setting is only available when “Stream(1)”, “Stream(2)”, “Stream(3)” is selected for “Recording format” of the SD memory card, and “Alarm input” is selected for “Save trigger”.

### [Pre alarm (recording) duration]

Determine whether or not to perform the pre alarm recording. Set the duration to save image data on the SD memory card.

Off/ 1s/ 2s/ 3s/ 4s/ 5s/ 8s/ 10s/ 15s/ 20s/ 25s/ 30s/ 40s/ 50s/ 60s/ 90s/ 120s

- **Default:** Off

**Note**

- The available values change depending on the bit rate and image capture size. As the selected bit rate increases, the available maximum value for the pre alarm duration decreases.

**[Post alarm (recording) duration]**

Set the duration to save image data on the SD memory card after an alarm occurrence.

10s/ 20s/ 30s/ 40s/ 50s/ 60s/ 120s/ 180s/ 240s/ 300s

- **Default:** 30s  
\* The actual recording time may sometimes be longer than the duration selected for this setting.

**SD memory card information**

**[Remaining capacity]**

Total capacity and remaining capacity of the SD memory card will be displayed.

Depending on the status of the SD memory card, the size indications will differ as follows.

Indication	Description
-----MB/-----MB	No SD memory card is inserted. Failed to obtain available capacity due to error, etc.
*****MB/*****MB	The SD memory card is unformatted.

**Note**

- When “Off” is selected for “Overwrite” and the available size of the SD memory card is “0 MB”, images will not be saved on the SD memory card. When the notification function is on, a notification will be sent to the registered addresses and destinations of the TCP alarm notification when the SD memory card becomes full. (→“2.6.2.1 Configure settings relating to alarm E-mail notifications”, “2.6.7 Configuration of the settings relating to alarm notification [Notification]”)

**[Format]**

To format the SD memory card, click the [Execute] button.

**IMPORTANT**

- Before formatting the SD memory card, it is necessary to select “Use” for “SD memory card” on the [SD memory card] tab of the “Basic” page (→“2.4.2 Configure the settings relating to the SD memory card [SD memory card]”).
- Use the SD memory card after formatting it using the [SD memory card] tab. If using the SD memory card that has not been formatted on the [SD memory card] tab, the following functions may not work correctly.
  - Save/obtain alarm images
  - Save/obtain images saved manually
  - Save/obtain images in accordance with the schedule settings
  - Save/obtain the alarm logs, the manual/schedule logs, and the system logs
  - Save/obtain images recorded using the SD memory recording function of our network disk recorder
  - Play/download images on the SD memory card
- When an SD memory card is formatted while another user is in operation, the operation will be canceled.
- It is impossible to access the SD memory card during the process of formatting.
- All data saved on the SD memory card will be deleted when the SD memory card is formatted.
- Do not turn off the power of the camera during the process of formatting.
- After formatting the SD memory card, available size may be smaller than the total size since the default directory is automatically created in the SD memory card.

- Refer to our website ([https://i-pro.com/global/en/surveillance/training\\_support/support/technical\\_information](https://i-pro.com/global/en/surveillance/training_support/support/technical_information) <Control No.:C0107>) for latest information about the compatible SD memory cards.
- When repeatedly recording images on an SD memory card using the auto overwrite function, make sure to use an SD memory card with high reliability and durability.
- Use the SD memory card that complies with UHS-1(Ultra High Speed-1) in the case of SD Speed Class10.

## **Possible duration of stream images (H.265) that can be saved on the SD memory card (as indications)**

For possible duration of stream images (H.265) that can be saved on the SD memory card, refer to our website below.

[https://i-pro.com/global/en/surveillance/training\\_support/support/technical\\_information](https://i-pro.com/global/en/surveillance/training_support/support/technical_information) <Control No.: C0307>

## 2.4.3 Configure the directory of the PC that images will be downloaded to [Log]

Click the [Log] tab on the “Basic” page. (→For menu display and how to operate, refer to “2.2.1 How to display the setup menu”, “2.2.2 How to operate the setup menu”)

The directory of the PC that images recorded on the SD memory card will be downloaded to can be configured in this section.

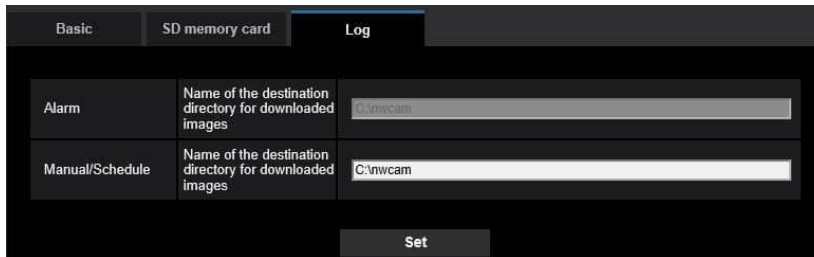

### Alarm

The settings related to the directory of the PC that recorded images of when alarms occur will be downloaded to can be performed.

#### [Recording stream] - [Name of the destination directory for downloaded images]

Enter the name of the destination directory to which images recorded in the recording stream are to be downloaded. For example, enter “C:\alarm” to designate the folder “alarm” under drive C.

- **Available number of characters:** 3 - 128 characters
- **Available characters:** Alphanumeric characters, the slash (/), the backslash (\), the colon (:), and the underscore (\_).

### Manual/Schedule

The settings related to the directory name of the PC that images recorded by manual saving or schedule saving will be downloaded to can be performed.

Designate the destination folder in the same manner as for “Alarm”.

## 2.5 Configure the settings relating to images

### [Image]

The settings relating to JPEG, H.265, and H.264 images such as the settings of image quality, etc. can be configured on this page.

The “Image” page has the [Image] tab, the [Image quality] tab.

### 2.5.1 Configure the settings relating to the image capture mode

#### [Image]

Click the [Image] tab on the “Image” page. (→For menu display and how to operate, refer to “2.2.1 How to display the setup menu”, “2.2.2 How to operate the setup menu”)

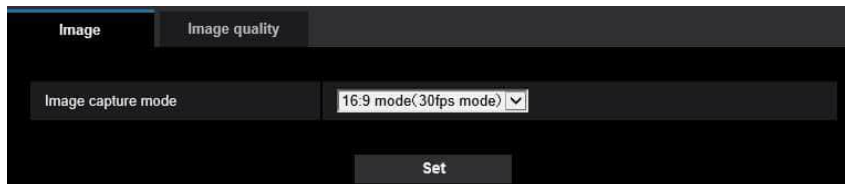

#### [Image capture mode]

Select an image to be displayed on the “Live” page.

U154x U254x **U114x** U214x

16:9 mode(30fps mode)/16:9 mode(25fps mode)/16:9 mode (2688x1520 30fps mode)/16:9 mode (2688x1520 25fps mode)

U153x U253x **U113x** U213x

16:9 mode(30fps mode)/4:3 mode(30fps mode)/16:9 mode(25fps mode)/4:3 mode(25fps mode)

**Default:** 16:9 mode(30fps mode)

#### **IMPORTANT**

- The positions of areas may move out of alignment when the “Image capture mode” setting is changed when the following area settings are configured. Therefore we recommend that you configure each area setting after configuring the “Image capture mode”.
  - mask area (→“2.5.4.2 Set mask areas”)
  - privacy zone (→“2.5.4.5 Configure the settings relating to the privacy zone (“Privacy zone” setup menu)”)
  - VMD area (→“2.6.3 Configure the VMD settings [VMD area]”)
  - SCD area (→“2.6.5 Configure the SCD settings [SCD area]”)
  - VIQS area (→“2.5.4.6 Configure the VIQS setting”)

## 2.5.2 Configure the settings relating to JPEG images [Image]

Click the [Image] tab on the “Image” page. (→For menu display and how to operate, refer to “2.2.1 How to display the setup menu”, “2.2.2 How to operate the setup menu”)

"Live" page (Initial display)		
Initial display stream	Stream(1) ▾	
Refresh interval (JPEG) *	3fps ▾	
JPEG		
JPEG(1)	Image capture size	1920x1080 ▾
	Image quality	5 Normal ▾
JPEG(2)	Image capture size	640x360 ▾
	Image quality	5 Normal ▾

### "Live" page (Initial display)

Configure the settings relating to the initial images displayed on the “Live” page.

#### [Initial display stream]

Select the image to display on the “Live” page from the following.  
JPEG(1)/JPEG(2)/Stream(1)/Stream(2)/Stream(3)

- **Default:** Stream(1)

#### Note

- When “JPEG(1)” or “JPEG(2)” is selected, the refresh interval can be selected.  
MJPEG/Refresh interval: 1s/Refresh interval: 3s/Refresh interval: 5s/Refresh interval: 10s/Refresh interval: 30s/Refresh interval: 60s
- “Stream(1)”, “Stream(2)”, “Stream(3)” is available when “On” is selected for [Stream transmission].

#### [Refresh interval (JPEG)\*]

Select an interval to refresh the displayed JPEG image from the following.

- When 30fps mode is selected for [Image capture mode]:  
0.1fps/ 0.2fps/ 0.33fps/ 0.5fps/ 1fps/ 2fps/ 3fps/ 5fps\*/ 6fps\*/ 10fps\*/ 12fps\*/ 15fps\*/ 30fps\*
- When 25fps mode is selected for [Image capture mode]:  
0.08fps/ 0.17fps/ 0.28fps/ 0.42fps/ 1fps/ 2.1fps/ 3.1fps/ 4.2fps\*/ 5fps\*/ 8.3fps\*/ 12.5fps\*/ 25fps\*

**Default:** 1fps

#### Note

- The refresh interval of JPEG(1) will be as follows.
  - When the 30 fps mode is set for [Image capture mode], the maximum refresh interval will be 10 fps.
  - When the 25 fps mode is set for [Image capture mode], the maximum refresh interval will be 8.3 fps.
- Depending on the settings of [Image capture mode], [Stream transmission] and [Frame rate\*], [Refresh interval (JPEG)\*] will be limited as follows.
  - When “16:9 mode(30fps mode)” is selected for [Image capture mode]:

	JPEG(1)	JPEG(2)
[Frame rate*] of either of Stream(1) or Stream(2) is "30fps"	Max. 1fps	Max. 1fps
[Frame rate*] of both of Stream(1) and Stream(2) is "15fps"	Max. 3fps	Max. 3fps
All of Stream(1) through Stream(3) are "On"	Max. 3fps	Max. 3fps
All of Stream(1) through Stream(3) are "Off"	Max. 10fps	Max. 30fps

- When "16:9 mode(25fps mode)" is selected for [Image capture mode]:

	JPEG(1)	JPEG(2)
[Frame rate*] of either of Stream(1) or Stream(2) is "25fps"	Max. 1fps	Max. 1fps
[Frame rate*] of both of Stream(1) and Stream(2) is "12.5fps"	Max. 3.1fps	Max. 3.1fps
All of Stream(1) through Stream(3) are "On"	Max. 3.1fps	Max. 3.1fps
All of Stream(1) through Stream(3) are "Off"	Max. 8.3fps	Max. 25fps

- When "16:9 mode (2688x1520 30fps mode)" is selected for [Image capture mode] **U154x**

**U254x** **U114x** **U214x** :

	JPEG(1)	JPEG(2)
Any of Stream(1) through Stream(3) are "On"	Max. 3fps	Not available
All of Stream(1) through Stream(3) are "Off"	Max. 10fps	Not available

- When "16:9 mode (2688x1520 25fps mode)" is selected for [Image capture mode] **U154x**

**U254x** **U114x** **U214x** :

	JPEG(1)	JPEG(2)
Any of Stream(1) through Stream(3) are "On"	Max. 3.1fps	Not available
All of Stream(1) through Stream(3) are "Off"	Max. 8.3fps	Not available

- When "On" is selected for "Stream transmission", the refresh interval may be longer than the set value when any value with an asterisk (\*) on the right is selected.

## 2 Settings

- Depending on factors such as the network environment, the resolution, the image quality, or the number of computers concurrently accessing the camera, the transmission interval may be longer than the set value.
- If images are not delivered in the specified transmission interval, you can make the images be delivered closer to the specified time by lowering the resolution or image quality.

## JPEG

Configure the settings such as “Image capture size”, “Image quality” of “JPEG(1)” or “JPEG(2)” on this section. Refer to “2.5.3 Configure the settings relating to Stream [Image]” for further information about the settings relating to H.265 (or H.264) images.

### [Image capture size]

Select the image capture size to display the JPEG image.

U154x U254x **U114x** U214x

Image capture mode	JPEG(1)	JPEG(2)
16:9 mode(30fps mode)/16:9 mode (25fps mode)	2560×1440 1920×1080 640×360 320×180	1920×1080 640×360 320×180
16:9 mode (2688x1520 30fps mode)/16:9 mode (2688x1520 25fps mode)	2688×1520 1920×1080 640×360 320×180	Not available

- **Default:**
  - When “16:9 mode(30fps mode)” or “16:9 mode(25fps mode)” is selected for [Image capture mode]:
    - **JPEG(1):** 2560×1440
    - **JPEG(2):** 640×360
  - When “16:9 mode (2688x1520 30fps mode)” or “16:9 mode (2688x1520 25fps mode)” is selected for [Image capture mode]:
    - **JPEG(1):** 2688×1520
    - **JPEG(2):** Not available

U153x U253x **U113x** U213x

Image capture mode	JPEG(1)	JPEG(2)
16:9 mode(30fps mode)/16:9 mode (25fps mode)	1920×1080 1280×720 640×360 320×180	1280×720 640×360 320×180
4:3 mode(30fps mode)/4:3 mode(25fps mode)	1600×1200 1280×960 VGA QVGA	1280×960 VGA QVGA

- **Default:**
  - **JPEG(1):** 1920×1080
  - **JPEG(2):** 640×360

**[Image quality]**

Select the image quality of JPEG images for each image capture size.

0 Super fine/ 1 Fine/ 2/ 3/ 4/ 5 Normal/ 6/ 7/ 8/ 9 Low

- **Default:** 5 Normal

## 2.5.3 Configure the settings relating to Stream [Image]

Click the [Image] tab on the “Image” page. (→For menu display and how to operate, refer to “2.2.1 How to display the setup menu”, “2.2.2 How to operate the setup menu”)

Configure the settings relating to H.265 (or H.264) image such as “Max bit rate (per client)”, “Image capture size”, “Image quality”, etc. in this section. Refer to “2.5.2 Configure the settings relating to JPEG images [Image]” for the settings relating to JPEG images.

### Note

- When the language setting of the browser selected at the time of administrator registration is Japanese, the default settings of some of the stream-related settings are different. Refer to “About the user manuals”.
- When [Image rotation] is set to “90 °” or “270 °”, the following settings for Stream(1) cannot be set simultaneously. **U154x** **U254x** **U114x** **U214x**
  - [Image capture size]: 2560x1440
  - [Frame rate\*]: “20fps\*” or more
  - [GOP control]: On(Advanced)

Stream(1)		
Stream encoding format	<input type="radio"/> H.265 <input checked="" type="radio"/> H.264	
Stream transmission	<input type="radio"/> On <input checked="" type="radio"/> Off	
Internet mode	<input checked="" type="radio"/> On <input type="radio"/> Off	
Image capture size	1920x1080	
Transmission priority	VBR	
Frame rate*	30fps*	
Max bit rate (per client) *	6144kbps* 6144 kbps	
Image quality	3	
Smart Coding	GOP control	Off
	Auto VIQS	<input checked="" type="radio"/> On <input type="radio"/> Off
Refresh interval	1s	
Transmission type	Unicast port (AUTO)	
Unicast port	32084 (1024-50000)	
Multicast address	225.192.0.25	
Multicast port	37000 (1024-50000)	
Multicast TTL/HOPLimit	16 (1-254)	

## Stream(1)/ Stream(2)/ Stream(3)

### [Stream transmission]

Select “On” or “Off” to determine whether or not to transmit H.265 (or H.264) images.

- **On:** Transmits H.265 (or H.264) images.
- **Off:** Does not transmit H.265 (or H.264) images.
- **Default:** Stream(1)/Stream(2): On, Stream(3): Off

### Note

- When “Image capture mode” is changed from “25fps”, [Frame rate\*] will become “25fps”.
- When “Stream transmission” of Stream(1), Stream(2) and Stream(3) is set to “On”, [Frame rate\*] of Stream(1) and Stream(2) will be limited to up to “15fps” (30fps mode) or “12.5fps” (25fps mode).

- When “Image capture size” is set to “1280x720” or “1280x960” in a state where “Stream transmission” of Stream(1) and Stream(2) is set to “On”, [Frame rate\*] of Stream(1) and Stream(2) will be limited to up to “15fps” (30fps mode) or “12.5fps” (25fps mode).
- When “16:9 mode (2688x1520 30fps mode)” or “16:9 mode (2688x1520 25fps mode)” is selected for [Image capture mode], “On” is available only for “Stream(1)”.  U154x  U254x  U114x  U214x
- When “On” is selected for “Stream transmission” in “Stream(1)”, “Stream(2)”, or “Stream(3)” displaying of H.265 (or H.264) images or JPEG images on the “Live” page will become available.
- When “On” is selected for “Stream transmission” in “Stream(1)”, “Stream(2)”, [Refresh interval (JPEG)\*] will be limited as follows.
  - When [Frame rate\*] of either of Stream(1) or Stream(2) is set to “30fps” (30fps mode) or “25fps” (25fps mode), [Refresh interval (JPEG)\*] will be limited to up to 1fps.
  - When [Frame rate\*] of either of Stream(1) or Stream(2) is set to “15fps” (30fps mode) or “12.5fps” (25fps mode), [Refresh interval (JPEG)\*] will be limited to up “3fps” (30fps mode) or up to “3.1fps” (25fps mode).
- When “On” is selected for “Stream transmission” for “Stream(1)”, “Stream(2)”, or “Stream(3)”, [Refresh interval (JPEG)\*] is limited to a maximum of 3fps(30fps mode) or 3.1fps(25fps mode).

### [Stream encoding format]

Select the stream encoding format for transmission.

- **H.265:** Transmits H.265 images.
- **H.264:** Transmits H.264 images.
- **Default:** H.265

### [Internet mode]

Select “On” when transmitting H.265 (or H.264) images via the Internet. It is possible to transmit stream without changing the broadband router settings configured for JPEG image transmission.

- **On:** H.265 (or H.264) images will be transmitted using the HTTP port. Refer to “[HTTP port]” for further information about the HTTP port number settings.
- **Off:** H.265 (or H.264) images will be transmitted using the UDP port.
- **Default:** On

### Note

- When “On” is selected, only “Unicast port (AUTO)” will be available for “Transmission type”.
- When “On” is selected, it may take time to start displaying stream images.
- When “On” is selected, stream images may not be displayed depending on the number of the concurrent access user, etc.
- When “On” is selected, only IPv4 access is available.

### [Image capture size]

Select the image capture size from the following. What can be selected may be limited depending on the image capture size already selected.

U154x  U254x  U114x  U214x

Image capture mode	Stream(1)	Stream(2)	Stream(3)
16:9 mode (30fps mode)/16:9 mode(25fps mode)	2560×1440 1920×1080 640×360 320×180	1920×1080 640×360 320×180	640×360 320×180

Image capture mode	Stream(1)	Stream(2)	Stream(3)
16:9 mode (2688x1520 30fps mode)/ 16:9 mode (2688x1520 25fps mode)	2688x1520 1920x1080 640x360 320x180	Not available (Off)	Not available (Off)

• **Default:**

When “16:9 mode(30fps mode)” or “16:9 mode(25fps mode)” is selected for “Image capture mode”:

- Stream(1): 2560x1440
- Stream(2): 640x360
- Stream(3): 320x180

When “16:9 mode (2688x1520 30fps mode)” or “16:9 mode (2688x1520 25fps mode)” is selected for “Image capture mode”:

- Stream(1): 2688x1520
- Stream(2): Not available
- Stream(3): Not available

U153x  U253x  U113x  U213x

Image capture mode	Stream(1)	Stream(2)	Stream(3)
16:9 mode (30fps mode)/16:9 mode(25fps mode)	1920x1080 1280x720 640x360 320x180	1280x720 640x360 320x180	640x360 320x180
4:3 mode (30fps mode)/4:3 mode(25fps mode)	1600x1200 1280x960 VGA QVGA	1280x960 VGA QVGA	VGA QVGA

• **Default:**

- Stream(1): 1920x1080
- Stream(2): 640x360
- Stream(3): 320x180

**[Transmission priority]**

Select a transmission priority for “Stream” from the following.

- **Constant bit rate:** H.265 (or H.264) images will be transmitted with the bit rate selected for “Max bit rate (per client)\*”.
- **VBR:** H.265 (or H.264) images will be transmitted with the frame rate selected for “Frame rate\*” while maintaining the image quality level selected in “Image quality”. In this case, images will be transmitted with the bit rate kept within the maximum bit rate that is set for “Max bit rate (per client)\*”. The recording capacity changes according to the “Image quality” setting and conditions of the subject.
- **Frame rate:** H.265 (or H.264) images will be transmitted with the frame rate selected for “Frame rate\*”.
- **Best effort:** In accordance with the network bandwidth, H.265 (or H.264) images will be transmitted with the maximum bit rates that are set for “Max bit rate (per client)\*”.

- **Default:** VBR

#### Note

- When “Frame rate” is set for “Transmission priority”, number of users who can access the camera may be limited.

#### [Frame rate\*]

Select a frame rate from the following.

- When 30fps mode is selected for [Image capture mode]:  
1fps/ 3fps/ 5fps\*/ 7.5fps\*/ 10fps\*/ 12fps\*/ 15fps\*/ 20fps\*/ 30fps\*
- When 25fps mode is selected for [Image capture mode]:  
1fps/ 3.1fps/ 4.2fps\*/ 6.25fps\*/ 8.3fps\*/ 12.5fps\*/ 20fps\*/ 25fps\*

**Default:** Stream(1) and Stream(2): 30fps\*, Stream(3): 15fps\*

#### Note

- “Frame rate\*” is restricted by “Max bit rate (per client)\*”. For this reason, the frame rate may be lower than the specified value when any value marked with an asterisk (\*) is selected. When “VBR” is selected for “Transmission priority”, depending on the settings of “Max bit rate (per client)\*” and “Image quality”, transmission of images may periodically be paused. Check the transmission of images after changing settings.
- Depending on the number of users connecting at the same time or the combination of features used, the frame rate may be lower than the configured value. Check the transmission of images after changing settings.

#### [Max bit rate (per client)\*]

Select an H.265 (or H.264) bit rate per a client from the following.

64kbps/ 128kbps\*/ 256kbps\*/ 384kbps\*/ 512kbps\*/ 768kbps\*/ 1024kbps\*/ 1536kbps\*/ 2048kbps\*/ 3072kbps\*/ 4096kbps\*/ 6144kbps\*/ 8192kbps\*/ 10240kbps\*/ 12288kbps\*/ 14336kbps\*/ 16384kbps\*/ 20480kbps\*/ 24576kbps\*/ — FREE ENTRY—

When “— FREE ENTRY—” is selected, the bit rate can be freely entered.

- **Default:**
  - Stream(1): 10240kbps\*     /6144kbps\*
  - Stream(2): 1536 kbps\*
  - Stream(3): 768 kbps\*

\* The range of bit rates that can be configured for H.265 (or H.264) bit rates differs depending on the “Transmission priority” and “Image capture size”.

When “Constant bit rate”, “Frame rate”, or “Best effort” is selected for “Transmission priority”

- QVGA, VGA, 320×180 and 640×360: 64kbps - 4096kbps\*
- 1280×960 and 1280×720<sup>1</sup>: 128kbps\* - 8192kbps\*
- 1920×1080<sup>1</sup>: 256kbps\* - 12288kbps\*
- 1600×1200: 512kbps\* - 12288kbps\*
- 2560×1440: 512kbps\* - 12288kbps\*

When “VBR” is selected for “Transmission priority”

- QVGA, VGA, 320×180 and 640×360: 64kbps - 12288kbps\*
- 1280×960 and 1280×720: 128kbps\* - 12288kbps\*
- 1920×1080: 256kbps\* - 24576kbps\*
- 1600×1200: 512kbps\* - 24576kbps\*
- 2560×1440: 512kbps\* - 24576kbps\*

### Note

- The bit rate for “Stream” is restricted by “Bandwidth control(bit rate)” on the [Network] tab on the “Network” page (→“2.8.1 Configure the network settings [Network]”). When a value with “\*” attached is set, images may not be streamed.
- When the refresh interval is short, the configured bit rate may be exceeded depending on the subject.
- Depending on the number of users connecting at the same time or the combination of features used, the bit rate may be lower than the configured value.  
Check the transmission of images after changing settings.

### [Image quality]

Select the image quality of H.265 (or H.264) images from the following.

- **For “Constant bit rate”, “Frame rate”, and “Best effort”:** Low(Motion priority)/Normal/Fine(Image quality priority)
- **“VBR”:** 0 Super fine/ 1 Fine/ 2/ 3/ 4/ 5 Normal/ 6/ 7/ 8/ 9 Low
- **Default:** 3

### [Smart Coding] - [GOP control]





By using “GOP control”, the transmission data volume can be reduced when there is little motion in the image.

- When “H.265” is selected as the “Stream encoding format”:  
Off/On(Low)/On(Mid)/On(Advanced)/On(Frame rate control)
- When “H.264” is selected as the “Stream encoding format”:  
Off/On(Low)/On(Mid)
- **Default:** Off

### IMPORTANT

- When “On(Low)”, “On(Mid)”, “On(Advanced)”, or “On(Frame rate control)” is selected, recording to an SD memory card cannot be performed.

### Note

- When “16:9 mode (2688x1520 30fps mode)” or “16:9 mode (2688x1520 25fps mode)” is selected for “Image capture mode”, “GOP control” cannot be set to “On”.    
- When using “GOP control”, the refresh interval is increased when streaming H.265 (or H.264) images. For this reason, do not use it when the network environment has frequent errors.
- “On(Low)”/“On(Mid)”/“On(Frame rate control)” can be selected only when “VBR” is selected for “Transmission priority”. “On(Advanced)” can be selected regardless of the “Transmission priority” setting.
- When “On(Frame rate control)” is selected, the frame rate ranges from 1fps to the value set in [Frame rate\*] depending on the size of image changes.
- When “On(Frame rate control)” is selected, the display may temporarily become slower or faster when changing frame rates.
- To set “On” for “GOP control”, when “Stream transmission” of Stream(1) and Stream(2) is set to “On”, [Frame rate\*] of Stream(1) and Stream(2) is needed to be less than “15fps” (30fps mode) or “12.5fps” (25fps mode).

### [Smart Coding] - [AUTO VIQS]

Maintains high image quality in the areas of the image containing moving objects, and reduces the transmission data volume in other areas of the image.

- **Off:** Does not use “AUTO VIQS”.
- **On:** Maintains high image quality in the areas of the image containing moving objects, and reduces the transmission data volume in other areas of the image.
- **Default:** Off

**Note**

- When “16:9 mode (2688x1520 30fps mode)” or “16:9 mode (2688x1520 25fps mode)” is selected for “Image capture mode”, “AUTO VIQS” cannot be set to “On”. **U154x** **U254x** **U114x** **U214x**
- This feature can only be used for “Stream(1)”.
- If “On” is selected, the VIQS setting set from the [Image quality] tab is disabled.
- To set “On” for “Auto VIQS”, when “Stream transmission” of Stream(1) and Stream(2) is set to “On”, [Frame rate\*] of Stream(1) and Stream(2) is needed to be less than “15fps” (30fps mode) or “12.5fps” (25fps mode).

**[Refresh interval]**

Select an interval (I-frame interval; 0.2 - 5 seconds) to refresh the displayed H.265 (or H.264) images from the following.

If using under a network environment with frequent error occurrences, shorten the refresh interval for H.265 to diminish image distortions. However, the image refresh speed may be lowered and the configured bit rate may be exceeded.

0.2s/ 0.25s/ 0.33s/ 0.5s/ 1s/ 2s/ 3s/ 4s/ 5s

- **Default:** 1s

**Note**

- When “On(Low)” is selected for “GOP control”, the refresh interval is set to Max. 8s.
- When “On(Mid)” is selected for “GOP control”, the refresh interval is set to Max. 16s.
- When “On(Advanced)” is selected for “GOP control”, the refresh interval is set to 60s.
- If “GOP control” is set to “On(Frame rate control)”, the frame rate ranges from 1fps to the value set in [Frame rate\*] depending on the size of image changes.  
The smaller the frame rate value, the longer the refresh interval. When the frame rate is the value set in [Frame rate\*], the refresh interval is at Max. 16s.

**[Transmission type]**

Select the transmission type of H.265 (or H.264) images from the following.

- **Unicast port (AUTO):** Up to 14 users can access a single camera concurrently. “Unicast port” will automatically be selected when transmitting images from the camera. When it is unnecessary to fix the port number for stream transmission such as when using in a particular LAN environment, it is recommended to select “Unicast port (AUTO)”.
- **Unicast port (MANUAL):** Up to 14 users can access a single camera concurrently. It is necessary to select “Unicast port” manually to transmit images from the camera.  
It is possible to fix the port number of the router used for stream transmission via the Internet by setting “Unicast port (MANUAL)” (→“2.8.1 Configure the network settings [Network]”). Refer to the operating instructions of the router in use.
- **Multicast:** Unlimited number of users can access a single camera concurrently. Complete the entry field of “Multicast address”, “Multicast port” and “Multicast TTL/HOPLimit” when transmitting stream with multicast. Refer to “1.1.1 Monitor images from a single camera” for further information about the maximum concurrent access number.
- **Default:** Unicast port (AUTO)

**[Unicast port]\*1**

Enter the unicast port number (used to transmit images from the camera).

- **Available port number:** 1024 - 50000 (Only even numbers are available.)
- **Default:**
  - Stream(1): 32004
  - Stream(2): 32014
  - Stream(3): 32024

### [Multicast address]<sup>\*2</sup>

Enter the multicast IP address. Images will be transmitted to the designated IP address.

- **Available IPv4 address:** 224.0.0.0 - 239.255.255.255
- **Available IPv6 address:** Multicast address starting with "FF"
- **Default:**
  - Stream(1): 239.192.0.20
  - Stream(2): 239.192.0.21
  - Stream(3): 239.192.0.22

### Note

- Enter a multicast IP address after checking available multicast address.

### [Multicast port]<sup>\*2</sup>

Enter the multicast port number (used to transmit images from the camera).

- **Available port number:** 1024 - 50000 (Only even numbers are available.)
- **Default:** 37004

### [Multicast TTL/HOPLimit]<sup>\*2</sup>

Enter a value for "Multicast TTL/HOPLimit".

- **Available value:** 1-254
- **Default:** 16

### **IMPORTANT**

- When transmitting stream images via the internet, the transmitted image sometimes may not be displayed depending on the settings of a proxy server or a firewall. In this case, refer to the network administrator.
- When two or more network interface cards are installed on the PC in use, the network interface card(s) not used for receiving images should be invalidated when displaying images using the multicast port.

---

<sup>\*1</sup> It is necessary to designate the unicast port number when "Unicast port (MANUAL)" is selected for "Transmission type".

<sup>\*2</sup> It is necessary to designate the multicast IP address when "Multicast" is selected for "Transmission type".

## 2.5.4 Configure the settings relating to image adjust, zoom/focus, extra zoom, privacy zone, VIQS [Image quality]

Click the [Image quality] tab on the “Image” page. (→For menu display and how to operate, refer to “2.2.1 How to display the setup menu”, “2.2.2 How to operate the setup menu”)

When the [Setup>>] button of each setting item is clicked, the detailed settings menu will be displayed in a newly opened window. The detailed settings can be configured while monitoring images displayed on the [Image quality] tab.

The settings relating to the image adjust, zoom/focus, extra zoom, privacy zone, VIQS can be configured on this page.

[WV-U2542LA] [WV-U2532LA] [WV-U1542LA] [WV-U1532LA] [WV-U2540LA] [WV-U2530LA] [WV-U2140LA] [WV-U2130LA]  
[WV-U2142LA] [WV-U2132LA] [WV-U1142A] [WV-U1132A] [WV-U1130A]

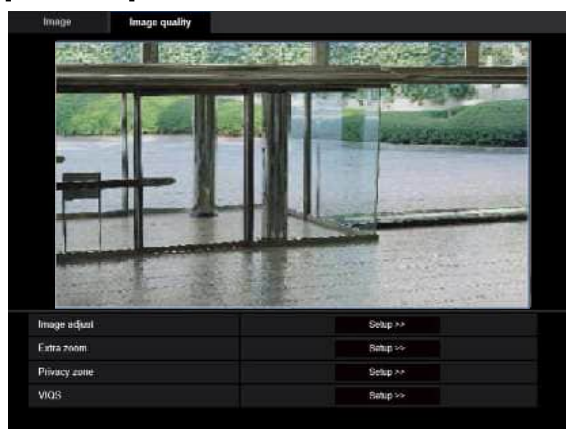
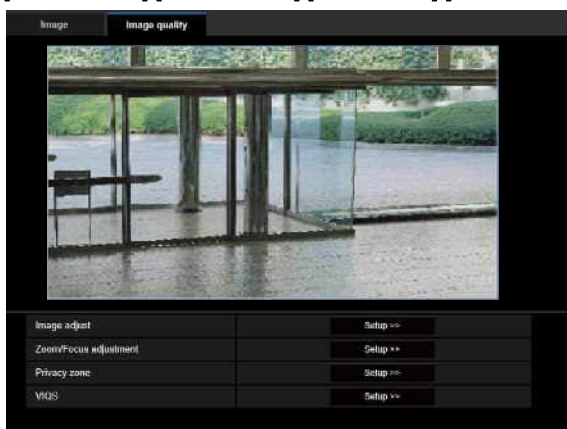

### [Image adjust]

Click the [Setup>>] button to display the setup menu that can configure the settings relating to image quality. The setup menu will be displayed in a newly opened window. (→“2.5.4.1 Configure the settings relating to image quality (“Image adjust” setup menu)”)

### [Zoom/Focus adjustment] [WV-U2542LA] [WV-U2532LA] [WV-U1542LA] [WV-U1532LA] [WV-U2142LA] [WV-U2132LA] [WV-U1142A] [WV-U1132A]

Click the [Setup>>] button to display the setup menu that can configure the settings relating to zoom/focus.

The setup menu will be displayed in a newly opened window. (→“2.5.4.3 Adjust the zoom and focus [WV-U2542LA] [WV-U2532LA] [WV-U1542LA] [WV-U1532LA] [WV-U2142LA] [WV-U2132LA] [WV-U1142A] [WV-U1132A]”)

### [Extra zoom] [WV-U2540LA] [WV-U2530LA] [WV-U2140LA] [WV-U2130LA] [WV-U1130A]

Click the [Setup>>] button to display the setup menu that can configure the settings relating to extra zoom.

The setup menu will be displayed in a newly opened window. (→“2.5.4.4 Adjust the angular field of view with extra zoom [WV-U2540LA] [WV-U2530LA] [WV-U2140LA] [WV-U2130LA] [WV-U1130A]”)

### [Privacy zone]

Click the [Setup>>] button to display the setup menu that can configure the settings relating to the privacy zone. The setup menu will be displayed. (→“2.5.4.5 Configure the settings relating to the privacy zone (“Privacy zone” setup menu)”)

### [VIQS]

Click the [Setup>>] button to display the setup menu that can configure the settings relating to VIQS. The setup menu will be displayed. (→“2.5.4.6 Configure the VIQS setting”)

### 2.5.4.1 Configure the settings relating to image quality (“Image adjust” setup menu)

Click the [Setup>>] button of “Image adjust” on the [Image quality] tab of the “Image” page. (→“2.5.4 Configure the settings relating to image adjust, zoom/focus, extra zoom, privacy zone, VIQS [Image quality]”)

The settings relating to image quality can be configured with the setup menu displayed in a newly displayed window. When the values are changed, the changed values will be applied to the currently displayed image on the [Image quality] tab.

Click the “+” mark on the left of each item in the setup menu to expand the respective item, and enable detailed settings.

Click the “-” mark on the left of an expanded item to return to the screen displayed before the item was expanded.

**<Example: Super dynamic (SD)>**

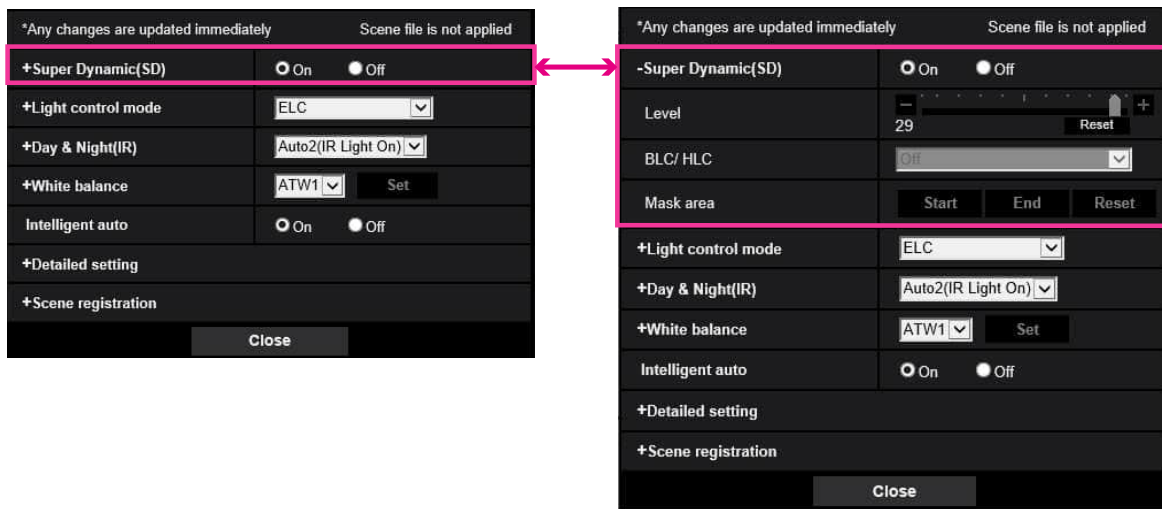

### Super Dynamic(SD)

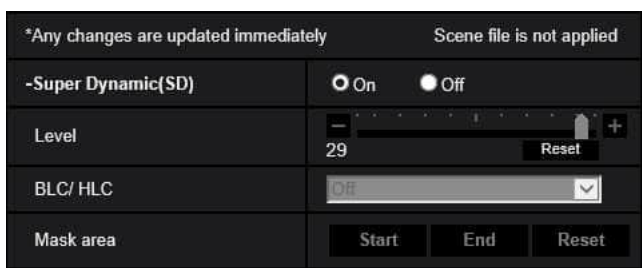

**[Super Dynamic(SD)]**

Select “On” or “Off” to determine whether or not to activate the super dynamic function.

Refer to the description “Super Dynamic function” (→“Super Dynamic function”) about the super dynamic function.

- **On:** The super dynamic function will work.
- **Off:** The super dynamic function will not work.
- **Default:** On

**Note**

- When the following are observed depending on the light condition, select “Off” for “Super Dynamic(SD)”.
  - When flickering appears or the color changes on the screen
  - When noise appears in the brighter area on the screen

**[Level]**

Adjust the super dynamic (SD) level.

If you move the slider in the “+” direction, a subject with high contrast can be captured without over exposure or under exposure.

If you move the slider in the “-” direction, the parts with medium brightness can be captured with rich gradation. Click the [Reset] button to reset to the default setting.

- **Default: 28**

**Note**

- When changing the level, the images may be distorted temporarily.

**Super Dynamic function**

When there is wide variation between the illumination of light and dark areas of the location being monitored, the camera adjusts the lens iris in accordance with the brighter areas. This causes loss of detail in darker areas. Conversely, adjusting the lens brightness for the darker areas causes the brighter areas to become washed out.

Super Dynamic digitally combines an image that is set up for a clear view of the brighter areas with an image that is set up for a clear view of the darker areas, creating a final image that preserves overall detail.

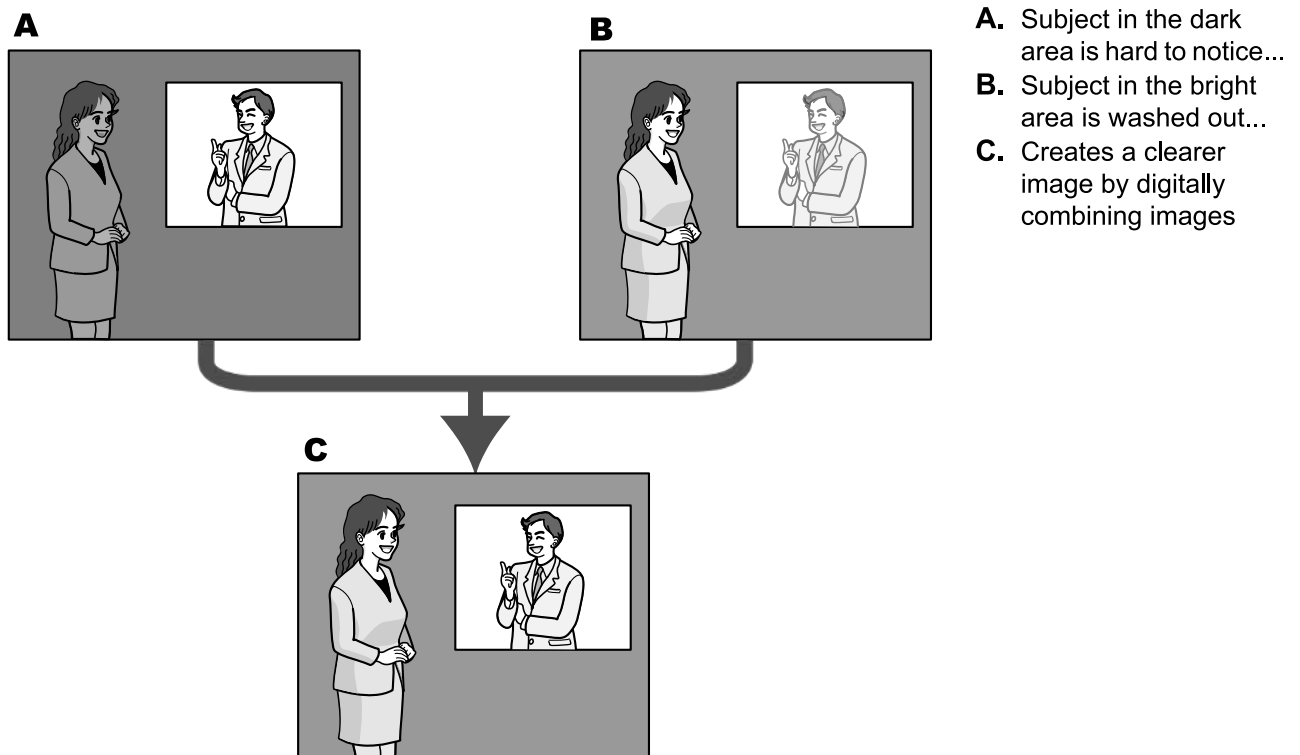
**[BLC/ HLC]**

Select from the following. When “On” is selected for “Super Dynamic(SD)” or when “On” is selected for “Intelligent auto”, this setting is not available.

- **Back light compensation (BLC):** Activates the back light compensation (BLC) function.

## 2 Settings

---

- **High light compensation(HLC):** Activates the high light compensation (HLC) function. The high light compensation function limits the over exposure of subjects caused bright light (such as light from headlights of cars) at night.
- **Off:** Deactivates the back light compensation function and high light compensation function.
- **Default:** Off

### [Mask area]

When mask area is set, the selected area is masked and you can adjust brightness. When “On” is selected for “Super Dynamic(SD)”, this setting is not available.

Refer to “2.5.4.2 Set mask areas” for information on how to set the mask area.

## Light control mode



### [Light control mode]

Select the light control mode from the following.

- **Indoor scene (50 Hz) / Indoor scene (60 Hz):** The shutter speed will automatically be adjusted to prevent flicker caused by fluorescent light. Select 50 Hz or 60 Hz corresponding to the location where the camera is in use.
- **ELC:** Uses shutter speed adjustment to control light.
- **Default:** ELC

### Note

- When 25fps mode is selected for [Image capture mode], “Indoor scene (60 Hz)” is not available.

### [Brightness]

Adjust the brightness.

If you move the slider in the “+” direction, the image will become brighter.

If you move the slider in the “-” direction, the image will become darker.

Click the [Reset] button to reset to the default brightness setting.

- **Default:** 64

### [Maximum gain]

Adjusts the maximum gain. When the luminance of the subject becomes darker, gain will be automatically increased and screen will become brighter. If you increase the gain, the noise may also increase.

If you move the slider in the “+” direction, the maximum gain will increase.

If you move the slider in the “-” direction, the maximum gain will decrease.

Click the [Reset] button to reset to the default setting.

- **Default:** 11

### [Maximum shutter]

The maximum shutter time adjusts the storage time of the sensor. The following are available for the recording duration.

- When 30fps mode is selected for [Image capture mode]:

Max.1/10000s, Max.1/4000s, Max.1/2000s, Max.1/1000s, Max.1/500s, Max.1/250s, Max.1/120s, Max.1/100s, Max.2/120s, Max.2/100s, Max.3/120s, Max.3/100s, Max.1/30s, Max.2/30s, Max.4/30s, Max.6/30s, Max.10/30s, Max.16/30s

- When 25fps mode is selected for [Image capture mode]:  
Max.1/10000s, Max.1/4000s, Max.1/2000s, Max.1/1000s, Max.1/500s, Max.1/250s, Max.1/100s, Max.2/100s, Max.3/100s, Max.1/50s, Max.1/25s, Max.2/25s, Max.4/25s, Max.6/25s, Max.10/25s, Max.16/25s
- **Default:** Max.1/30s

### IMPORTANT

- If the following value is set for “Maximum shutter”, the frame rate may drop when the subject is dark.
  - A value longer than “Max.1/30s” (Max.2/30s/ Max.4/30s/ Max.6/30s/ Max.10/30s/ Max.16/30s) when the 30 fps mode is set for [Transmission priority]
  - A value longer than “Max. 1/25s” (Max. 2/25s/ Max. 4/25s/ Max. 6/25s/ Max. 10/25s/ Max. 16/25s) when the 25 fps mode is set for [Transmission priority]

### Note

- When “On” is selected for “Super Dynamic(SD)”, “Max.1/2000s”, “Max.1/4000s” and “Max.1/10000s” are not available.
- If “0” is selected for “Maximum gain”, the setting of “Maximum shutter” will be restricted as follows:
  - When 30fps mode is selected for [Image capture mode], “Max. 2/30s” or higher is not available.
  - When 25fps mode is selected for [Image capture mode], “Max. 2/25s” or higher is not available.
- When “Light control mode” is set to “Indoor scene (60 Hz)”, a shorter time than “Max. 1/120s” cannot be set.
- When “Light control mode” is set to “Indoor scene (50 Hz)”, a shorter time than “Max. 1/100s” cannot be set.

## Day & Night(IR)

-Day & Night(IR)	Auto2(IR Light On) ▾
Level	<input checked="" type="radio"/> High <input type="radio"/> Low
Dwell time	10s ▾
IR LED light intensity	High ▾
Intensity control	<input checked="" type="radio"/> On <input type="radio"/> Off

### [Day & Night(IR)]

Select switching between the color mode and the black & white mode from the following.

U254x U253x U214x U213x U154x U153x

- **Off:** The color mode is selected.
- **On(IR Light Off):** Always captured as black & white images.
- **On(IR Light On):** Always captured as black & white images. Suitable when using near-infrared lighting at night.
- **Auto1(IR Light Off):** The camera automatically switches between the color mode and the black & white mode in accordance with the picture brightness (luminance).
- **Auto2(IR Light On):** The camera automatically switches between the color mode and the black & white mode in accordance with the picture brightness (luminance). Suitable when using near-infrared lighting at night.
- **Auto3(SCC):** Suitable to keep the color mode even under darker light condition. The Super Chroma Compensation (SCC) function retains the color mode even with dim lighting.

- **Default:** Auto2(IR Light On)

### **U114x** **U113x**

- **Off:** The color mode is selected.
- **On:** Always captured as black & white images.
- **Auto1(Normal):** The camera automatically switches between the color mode and the black & white mode in accordance with the picture brightness (luminance).
- **Auto2(IR Light):** The camera automatically switches between the color mode and the black & white mode in accordance with the picture brightness (luminance). Suitable when using near-infrared lighting at night.
- **Auto3(SCC):** Suitable to keep the color mode even under darker light condition. The Super ChromaCompensation (SCC) function retains the color mode even with dim lighting.
- **Default:** Auto1(Normal)

### **Super Chrome Compensation (SCC) function**

This function achieves faithful color images using the proprietary color compensation technology that reproduce images even under low illumination where it is usually difficult to capture objects faithfully.

### **IMPORTANT**

- If the focus cannot be automatically adjusted, refer to “2.5.4.3 Adjust the zoom and focus [WV-U2542LA] [WV-U2532LA] [WV-U1542LA] [WV-U1532LA] [WV-U2142LA] [WV-U2132LA] [WV-U1142A] [WV-U1132A]”. [WV-U2542LA] [WV-U2532LA] [WV-U1542LA] [WV-U1532LA] [WV-U2142LA] [WV-U2132LA] [WV-U1142A] [WV-U1132A]

### **Note**

- Since the color compensation technology is used for “Auto3(Super Chrome Compensation(SCC))”, some colors may look different from the actual objects depending on the light condition (such as when infrared lights are used).
- The operating sound might be heard when changing to black-and-white mode, however it does not indicate any malfunction.
- The color mode and the black & white mode may not be switched automatically depending on the environment. In such a case, use the schedule function to switch the color and the black & white mode. For how to set up, refer to the following our support website.  
[https://i-pro.com/global/en/surveillance/training\\_support/support/technical\\_information](https://i-pro.com/global/en/surveillance/training_support/support/technical_information) <Control No.: C0314>

### **[Level]**

Select the threshold illuminance level (brightness) to switch between the color mode and the black & white mode. The descriptions about the following threshold illuminance levels are given when “Off” is selected for “Super Dynamic(SD)”.

- **High:** Switches from the color mode to the black & white mode when the ambient brightness (illuminance) of the camera is approx. 2 lx or less.
- **Low:** Switches from the color mode to the black & white mode when the ambient brightness (illuminance) of the camera is approx. 1 lx or less.
- **Default:** High

### **Note**

- When a low value is selected for “Maximum gain”, it may be difficult to switch modes depending on the environment.

### **[Dwell time]**

Select a wait time for switching between the color mode and the black & white mode from the following.  
2s/ 10s/ 30s/ 1min

- **Default:** 10s

**[IR LED light intensity]** U254x U253x U214x U213x U154x U153x

Select the IR LED light intensity from High/Middle/Low.

- **Default:** High

**[Intensity control]** U254x U253x U214x U213x U154x U153x

Select On/Off to determine whether or not to activate the IR Light over exposure suppression function.

- **Default:** Off

## White balance

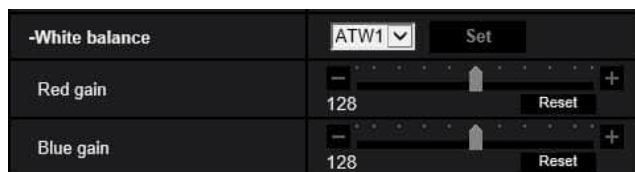
**[White balance]**

Select a method of white balance adjustment from the following.

White color can be adjusted by “Red gain” and “Blue gain”.

- **ATW1:** Selects the automatic tracing white balance mode. The camera will constantly check the color temperature of the light source and adjust the white balance automatically. Operating color temperature range is approx. 2,700 K to 6,000 K.
- **ATW2:** Selects the automatic tracing white balance mode under a sodium lamp. The camera will adjust the white balance automatically under a sodium lamp. Operating color temperature range is approx. 2,000 K to 6,000 K.
- **AWC:** Selects the automatic white balance control mode. This adjustment is suitable for a location where a light source is stable. Operating color temperature range is approx. 2,000 K to 10,000 K.
- **Default:** ATW1

**Note**

- Under the following conditions, color may not be faithfully processed. In these cases, select “AWC”.
  - When shooting a subject whose major part is a thick color
  - When shooting blue sky or sun at sunset
  - When shooting a subject whose luminance is too low
- When “AWC” is selected, click the [Set] button.

**[Red gain]**

Adjust the red color of images.

When the slider is moved in the “+” direction, the red color will become thicker. When the slider is moved in the “-” direction, the red color will be thinner. Click the [Reset] button to reset the color to the default.

- **Default:** 128

**[Blue gain]**

Adjust the blue color of images.

When the slider is moved in the “+” direction, the blue color will become thicker. When the slider is moved in the “-” direction, the blue color will be thinner. Click the [Reset] button to reset the color to the default.

- **Default:** 128

### Intelligent auto



#### [Intelligent auto]

Select On/Off to determine whether or not to activate the “Intelligent auto” function.

“Intelligent auto” can detect conditions (back lighting, outdoor, night time, etc.) or moving objects and then automatically adjust the camera’s aperture, gain, shutter speed, and contrast in order to display moving objects more clearly.

- **Default:** On

#### Note

- Be aware that flicker may occur due to fluorescent lighting when activating the Intelligent auto function. In such a case, set the following:
  - Change “Light control mode” to “Indoor scene (50 Hz)” or “Indoor scene (60 Hz)”.

### Detailed setting

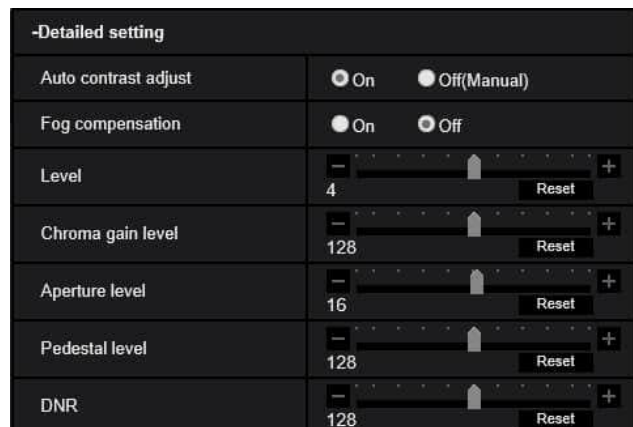

#### [Auto contrast adjust]

Select On/Off(Manual) to determine whether or not to activate the auto contrast adjust function.

**On:** Activates the auto contrast adjust function.

**Off:** Stops the auto contrast adjust function.

- **Default:** On

#### Note

- When “On” is selected for “Intelligent auto”, this setting is not available.

#### [Fog compensation]

Select “On” or “Off” to determine whether or not to activate the fog compensation function. When “On” is selected for “Auto contrast adjust”, or when “On” is selected for “Intelligent auto”, this setting is not available. The fog compensation function can make dim images that have been affected by fog or other conditions clearer using digital image processing.

- **On:** Activates the fog compensation function.
- **Off:** Stops the fog compensation function.
- **Default:** Off

**[Level]**

Adjust the fog compensation level.

The level of fog compensation will increase when the slider is moved in the “+” direction, and decrease when the slider is moved in the “-” direction. Click the [Reset] button to reset to the default setting.

- **Default:** 4

**[Chroma gain level]**

Adjusts the chroma level (color density).

If you move the slider in the “+” direction, the colors will become loud and vivid. If you move the slider in the “-” direction, the colors will become subdued. Click the [Reset] button to reset the color to the default.

- **Default:** 128

**[Aperture level]**

Adjust the aperture level (outline compensation).

If you move the slider in the “+” direction, the outline of the image will become sharper, and if you move it in the “-” direction, the outline of the image will become softer. Click the [Reset] button to reset the color to the default.

- **Default:** 16

**[Pedestal level]**

Adjust the black level of images by moving the slider.

When the slider is moved to the “+” direction, images will become brighter. When the slider is moved to the “-” direction, images will be darker. Click the [Reset] button to reset the color to the default.

- **Default:** 128

**[DNR]**

The digital noise reduction function reduces noise automatically under the condition of low illuminance.

If you move the slider in the “+” direction, the noise reduction effect is strengthened. There may be many afterimages.

If you move the slider in the “-” direction, the noise reduction effect is weakened. There are fewer afterimages. Click the [Reset] button to reset to the default setting.

- **Default:** 128

## Scene registration

**[Scene file]**

The combination of settings used to adjust image quality can be saved as a scene file. The scene file can be selected here.

Registered scene files can be configured in the “Schedule” page (→“2.9 Configure the settings relating to the schedules [Schedule]”). If the timing of when images are viewed greatly affects the area where images are viewed, registering scene files to the schedule can let you match a combination of settings to different times of day in order to view images in the best conditions.

**[Scene file title]**

The scene file name (up to 10 characters) displayed in “Scene file” can be changed. Only file names displayed in “1:”, “2:”, “3:”, and “4:” can be changed.

- **Unavailable characters:** " & \

### [Load] button

Loads the setting data selected in “Scene file” and changes the current image accordingly.

### [Register] button

The combination of settings used to adjust image quality that are currently displayed can be registered to the scene file displayed in “Scene file”.

## 2.5.4.2 Set mask areas

This explains how to mask an area of the image and adjust brightness.

When setting the mask area, set “Super Dynamic(SD)” to “Off”.

1. Display the “Image adjust” setup menu. (→“2.5.4 Configure the settings relating to image adjust, zoom/focus, extra zoom, privacy zone, VIQS [Image quality]”)

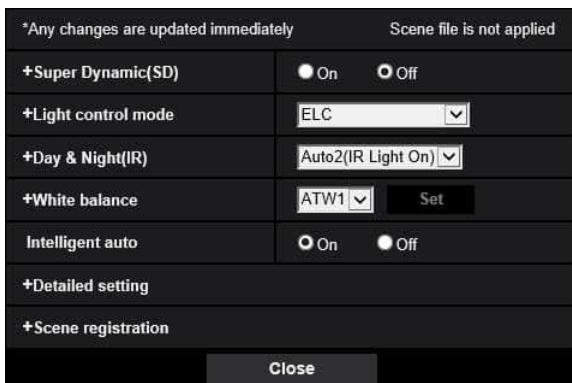

2. Click “+” on the left of “Super Dynamic(SD)” to display the detailed SD menu.

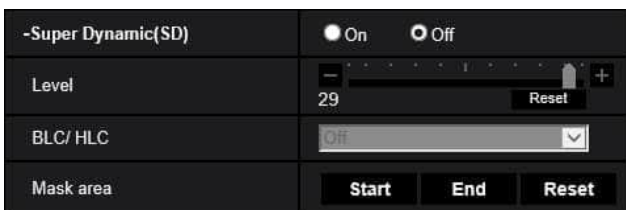

**3.** Click the [Start] button of “Mask area”.

→ Borders will appear and the image displayed on the [Image quality] tab will be divided into 48 (8×6).

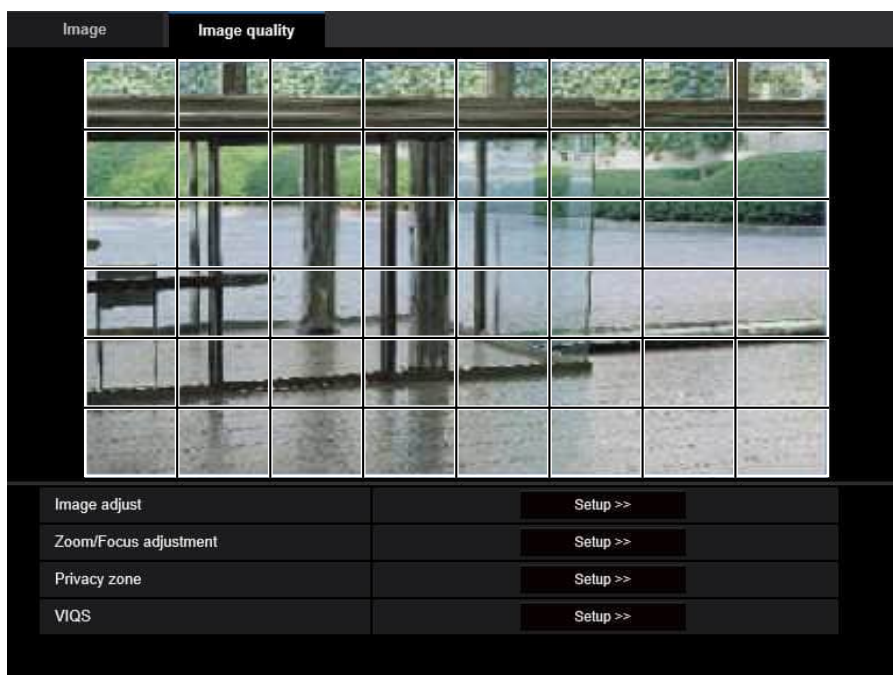

**4.** Click the divided areas to be masked.

→ The clicked areas will be masked and will become white. To cancel masking, click the area again.

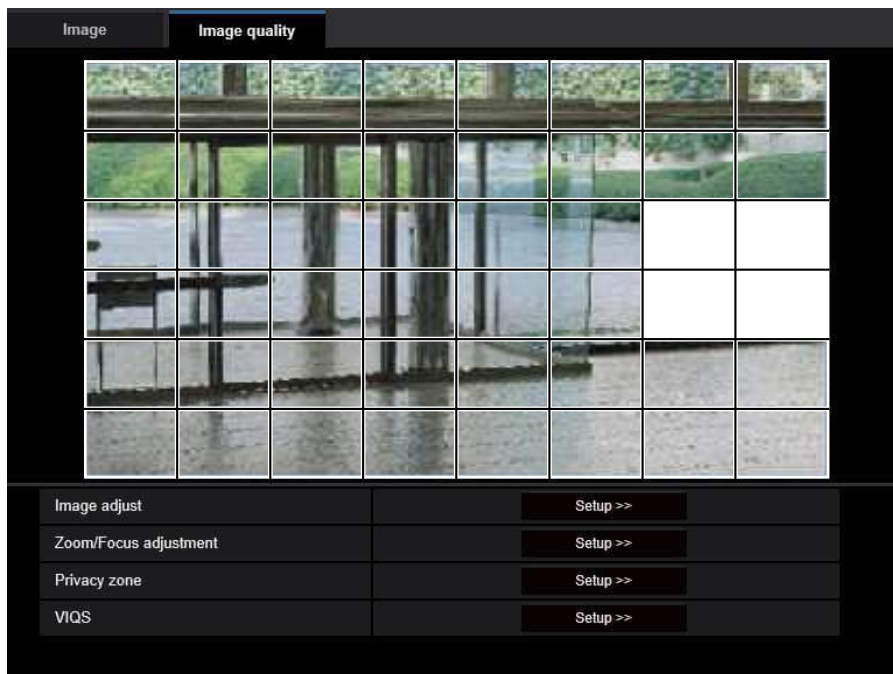

**5.** Click the [End] button after completing masking areas.

→ The borders on the image displayed on the [Image quality] tab will disappear.

### IMPORTANT

- The mask area may move out of alignment if the setting for “Image capture mode” of the [Image] tab, or “Image rotation” of the [Basic] tab is changed after the mask area has been configured. Make sure to check the mask area after changing the settings.
- The mask area may move out of alignment when “Optical zoom” and “Extra optical zoom” is configured. Make sure to check the mask area after configuring “Optical zoom” and “Extra optical zoom”. [WV-U2542LA] [WV-U2532LA] [WV-U1542LA] [WV-U1532LA] [WV-U2142LA] [WV-U2132LA] [WV-U1142A] [WV-U1132A]
- Configure mask area settings with a zoom ratio of x1.0 used for extra zoom. The mask area operates in the mask position of zoom ratio of x1.0 even after extra zoom settings. [WV-U2540LA] [WV-U2530LA] [WV-U2140LA] [WV-U2130LA] [WV-U1130A]

### Note

- When the [Reset] button is clicked, masking for all the masked areas will be canceled.

### 2.5.4.3 Adjust the zoom and focus [WV-U2542LA] [WV-U2532LA] [WV-U1542LA] [WV-U1532LA] [WV-U2142LA] [WV-U2132LA] [WV-U1142A] [WV-U1132A]

Click the [Setup>>] button of “Zoom/Focus adjustment” on the [Image/Privacy] tab of the “Image” page. (→“2.5.4 Configure the settings relating to image adjust, zoom/focus, extra zoom, privacy zone, VIQS [Image quality]”)

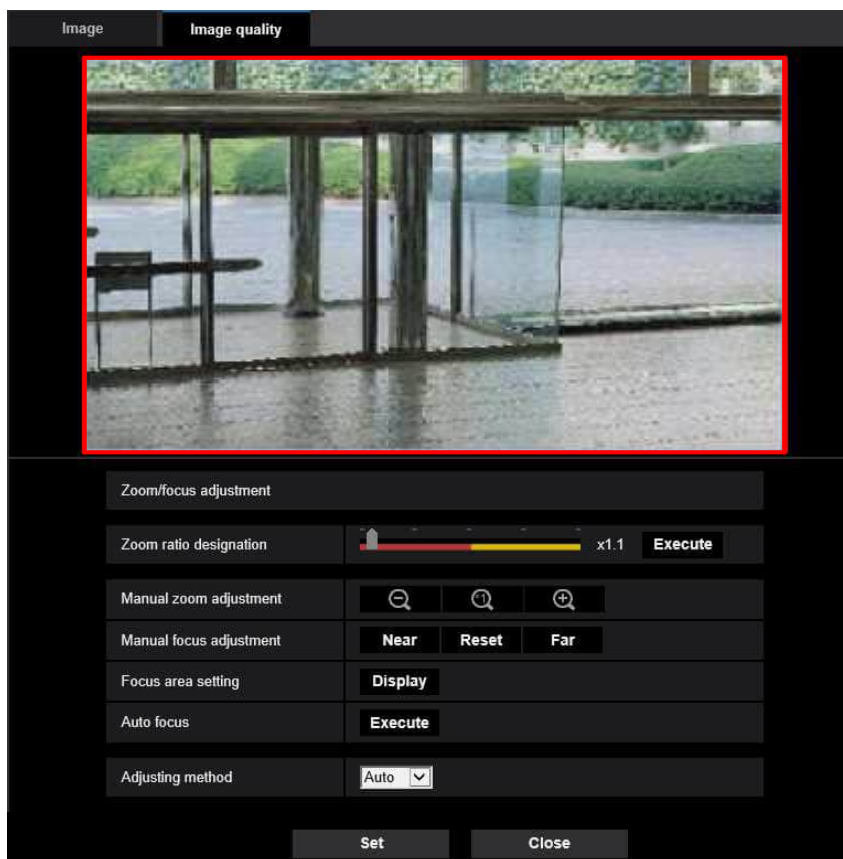

## Zoom/Focus adjustment

It is possible to adjust the angular field of view using the zoom and the extra optical zoom.  
Adjust the focus setting by moving the lens focus to the appropriate position.  
Manual and auto adjustments are available.

### [Zoom ratio designation]

The zoom and focus can be adjusted at the same time.



Operate the slider to enlarge/reduce the angular field of view adjustment outline in the image.

When adjusting the zoom ratio to the “Tele” side, only the angular field of view adjustment outline is reduced, and it is possible to determine the zoom ratio while checking the angular field of view after zooming is performed.

When adjusting the zoom ratio to the “Wide” side, the image itself is zoomed out of or the angular field of view adjustment outline is enlarged, and it is possible to determine the zoom ratio while checking the image size after zooming is performed.

After the angular field of view adjustment outline is adjusted, zooming is performed, and the auto focus function starts to automatically adjust focus based on a subject located in the center of the screen by clicking the [Execute] button.

### Note

- The red area of the slider and angular field of view adjustment outline represents optical zoom, and the yellow area represents extra optical zoom. The maximum magnification for optical zoom and extra optical zoom varies depending on the model and settings of the [Image capture mode].
- If you click the  button or  button of [Manual zoom adjustment], [Zoom ratio designation] cannot be operated. To perform [Zoom ratio designation], click the [Load] button, or the  button of [Manual zoom adjustment].
- The specified zoom ratio may not be obtained with [Zoom ratio designation]. In that case, specify the zoom ratio and reopen the menu window. Then, make adjustment again with [Zoom ratio designation] or [Manual zoom adjustment] as required.

### [Manual zoom adjustment]

The zoom can be adjusted manually.

: Click this button to adjust the zoom ratio to the “Wide” side until x1.0.

: Click this button to set the zoom ratio to x1.0.

: Click this button to adjust the zoom ratio to the “Tele” side.

### Note

- The camera switches between optical zoom and extra optical zoom depending on the zoom ratio. The supported optical and extra optical zoom ratios vary depending on the model and the selected image capture mode.
- When “Image capture size” is set to “640x360” or a higher resolution, image quality may deteriorate depending on the zoom ratio. For further information, refer to our website <Control No.: C0124>.

## IMPORTANT

- If optical zoom and extra optical zoom are configured after configuring settings for the mask area (→“2.5.4.2 Set mask areas”), privacy zone (→“2.5.4.5 Configure the settings relating to the privacy zone (“Privacy zone” setup menu)”), VMD area (→“2.6.3 Configure the VMD settings [VMD area]”), VIQS area (→“2.5.4.6 Configure the VIQS setting”), and SCD area (→“2.6.5 Configure the SCD settings [SCD area]”), the configured areas for those settings may move out of alignment. Therefore, perform the settings for optical zoom and extra optical zoom function before other settings.

### [Manual focus adjustment]

The focus can be adjusted manually.

- **[Near]:** Click this button to adjust the focus to the “Near” side.
- **[Reset]:** Click this button to reset the focus to the default.
- **[Far]:** Click this button to adjust the focus to the “Far” side.

### Note

- One-click of the [Near] or [Far] button is a fine adjustment, and it can look like there is no change in the focus. To shift the focus point largely, keep the button pressed.

### [Auto focus area setting]

When performing auto focus, you can use this frame to specify the subject on the screen for which the focus should be adjusted. Unless specified otherwise, adjusts the focus to the subject in the central area of the screen.

- **[Display]:** Displays the auto focus frame in the settings screen. In the default settings, the auto focus frame is displayed in the central area of the screen. Drag the mouse on the image, and specify the area where the focus should be adjusted. Once the setting is complete, click the [Register] button. When the [Display] button is clicked, the [Reset] and [Register] buttons are displayed.
- **[Reset]:** Resets the frame setting to its default. To register, click the [Register] button.
- **[Register]:** Saves the set frame. Click to automatically adjust the focus on the subject in the specified area.

### [Auto focus]

The auto focus function starts to automatically adjust focus based on a subject located in the center of the screen by clicking the [Execute] button.

### **IMPORTANT**

- With 30fps mode selected for [Image capture mode], if “Auto focus” is executed during slow shutter operation at night while a value longer interval than “Max. 1/30s” (Max. 2/30s, Max. 4/30s, Max. 6/30s, Max. 10/30s, or Max. 16/30s) is selected for “Maximum shutter”, completing auto focus may take a long time.
- With 25fps mode selected for [Image capture mode], if “Auto focus” is executed during slow shutter operation at night while a value longer interval than “Max. 1/25s” (Max. 2/25s, Max. 4/25s, Max. 6/25s, Max. 10/25s, or Max. 16/25s) is selected for “Maximum shutter”, completing auto focus may take a long time.
- In the following locations or with the following subjects, the focus may not be able to be automatically adjusted. In this case, manually adjust the focus.
  - when the subject moves a lot
  - when there are large changes to the lighting intensity
  - when the light level is low
  - when the subject or location is extremely bright or reflective
  - when viewing through windows
  - when the dome cover is in a location where it can easily become dirty
  - locations where there is not much contrast such as a white wall
  - when there is harsh flickering
- When images in the near-infrared light area change from color to black & white, images may be out of focus due to the nature of optical properties. In this case, the focus can automatically be corrected by selecting “Auto” or “Preset” for “Adjusting method” (the focus will not automatically be adjusted according to the illumination level change once the focus is corrected).

### [Adjusting method]

Select the focus adjustment method upon switching between the color mode and the black & white mode. For further information, refer to our website <Control No.: C0315>.

- **Auto:** When color/BW of an image on which the final focus adjustment is performed is switched, the focus will automatically be adjusted. When switched back to the previous color/BW, the focus position will return to the position determined when the final focus adjustment was performed. If the focus of an image could not be adjusted as a black & white image, the image may be readjusted as a color image and then switched again to a black & white image.
- **Preset:** Performs the preset movement to each specified focus position when switching between color and black & white images. The preset position is the focus position specified last time, which was automatically memorized for each of color images and black & white images.
- **Fix:** Fixes the position after adjusting the focus either automatically or manually.
- **Default:** Auto

### **IMPORTANT**

- If the focus cannot be adjusted automatically when switching between the color mode and the black & white mode when “Auto” is selected, select “Preset” or “Fix” and adjust the focus manually.

### **[Close] button**

Click this button to close the “Zoom/Focus adjustment” setup menu.

## **2.5.4.4 Adjust the angular field of view with extra zoom [WV-U2540LA] [WV-U2530LA] [WV-U2140LA] [WV-U2130LA] [WV-U1130A]**

Click the [Setup>>] button of “Extra zoom” on the [Image/Privacy] tab of the “Image” page. (→“2.5.4 Configure the settings relating to image adjust, zoom/focus, extra zoom, privacy zone, VIQS [Image quality]”) It is possible to adjust the angular field of view using the extra zoom function.



- Click this button to adjust the zoom ratio to the “Wide” side.
- Click this button to set the zoom ratio to x1.0.
- Click this button to adjust the zoom ratio to the “Tele” side.

### **Note**

- The maximum zoom ratio for extra zoom varies depending on the model and the selected [Image capture mode].
- Refer to the Important Information for more information about the maximum zoom ratio.

### **IMPORTANT**

- The extra zoom function may not be activated on the appropriate position if the setting for the function is performed after the settings for the VIQS area (→“2.5.4.7 Configure the VIQS area”), VMD area (→“2.6.4 Set the VMD areas [VMD area]”), SCD area (→“2.6.6 Set the SCD areas [SCD area]”), or privacy zone (→“2.5.4.5 Configure the settings relating to the privacy zone (“Privacy zone” setup menu”). Therefore, configure each area's settings after configuring the extra zoom settings.
- Configure mask area settings with a zoom ratio of x1.0. The mask area (→“2.5.4.2 Set mask areas”) operates in the mask position of zoom ratio of x1.0 even after extra zoom settings.

### 2.5.4.5 Configure the settings relating to the privacy zone (“Privacy zone” setup menu)

Click the [Setup>>] button of “Privacy zone” on the [Image quality] tab of the “Image” page. (→“2.5.4 Configure the settings relating to image adjust, zoom/focus, extra zoom, privacy zone, VIQS [Image quality])  
When there is a zone that you do not want to display, set the zone as a privacy zone is filled with gray. Up to 8 privacy zones can be set.

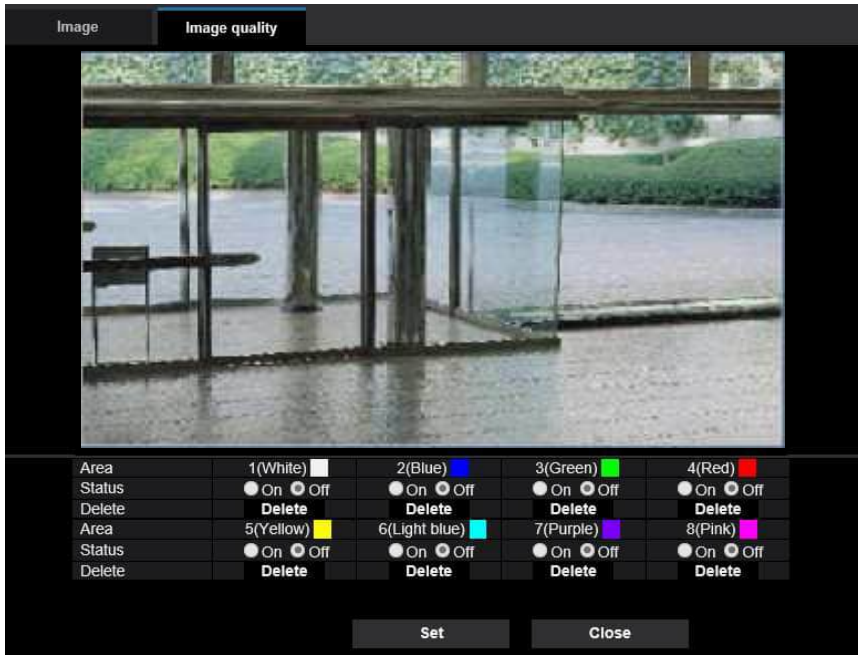

#### Example of privacy zone setting

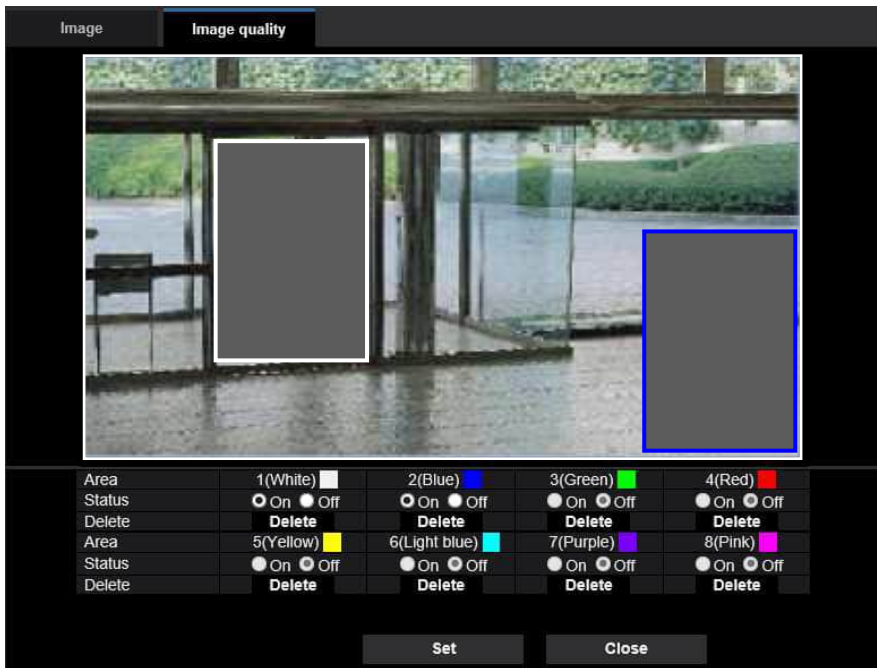

**[Area]**

The privacy zone will be set when an area is designated by dragging the mouse. Each zone can be overlapped. The zones are numbered sequentially from area 1.

**Note**

- Set the privacy zone larger than the size of an object to be hidden.

**[Status]**

Select “On” or “Off” to determine whether or not to display the privacy zone.

- **On:** The privacy zone will be displayed.
- **Off:** The privacy zone will not be displayed.
- **Default:** Off

**[Delete] button**

Click the [Delete] button corresponding to the zone to be deleted.

**[Close] button**

Click this button to close the “Privacy zone” setup menu.

**IMPORTANT**

- The privacy zone may move out of alignment if the settings for “Image capture mode” of the [Image] tab, or “Image rotation” of the [Basic] tab are changed. Make sure to check the privacy zone setting after changing the settings.
- After configuring the privacy zone, the privacy zone may move out of alignment when the “Optical zoom” or “Extra optical zoom” setting is changed. Make sure to check the privacy zone after changing the setting. [WV-U2542LA] [WV-U2532LA] [WV-U1542LA] [WV-U1532LA] [WV-U2142LA] [WV-U2132LA] [WV-U1142A] [WV-U1132A]
- Note that VMD and SCD do not function in the area where the privacy zone is set.

### 2.5.4.6 Configure the VIQS setting

Click the [Setup>>] button of “VIQS” on the [Image quality] tab of the “Image” page. (→“2.5.4 Configure the settings relating to image adjust, zoom/focus, extra zoom, privacy zone, VIQS [Image quality]”)

VIQS is an abbreviation of Variable Image Quality on Specified area and is a feature that enables you to change the images of a specified area.

It is possible to enhance the image quality of the specified range within a shooting area (image).

It is also possible to moderate the image data size by lowering the image quality of other areas.

The VIQS setting is available only for H.265 (or H.264) images.

Up to 8 VIQS areas can be set.

To check the image after configuring VIQS, when H.265 (or H.264) images are selected under “Stream”, you can check the image by pressing the [Confirm] button. You can also check by displaying an H.265 (or H.264) image on the “Live” page.

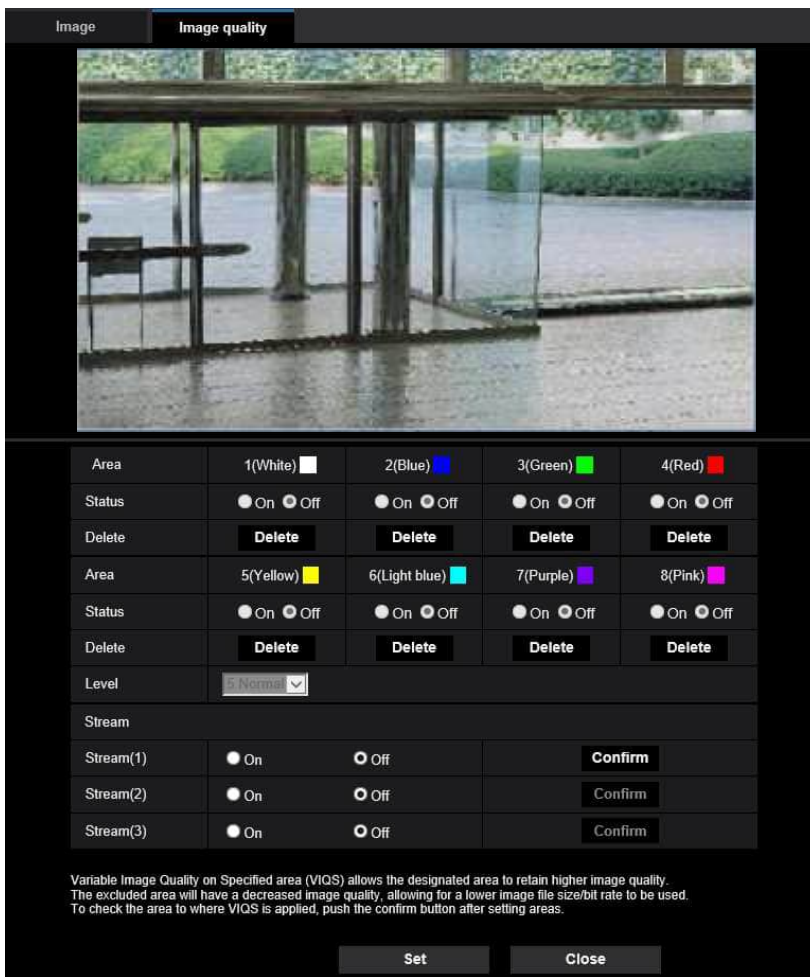

**[Area]**

When selecting a VIQS area in the screen, it will be numbered as area 1. (Subsequent areas will be numbered in the order of selection.)

**[Status]**

Select “On” or “Off” to determine whether or not to use the VIQS area.

- **On:** The VIQS area will be set.
- **Off:** Does not set the VIQS area.

- **Default:** Off

### **[Delete] button**

Deletes the VIQS area. Click the button to delete the VIQS area.

### **[Level]**

Configure the difference level in the image quality between specified areas and non-specified areas. The greater the difference level, the more the image quality of the non-specified area is reduced. This makes it possible to moderate the image data size.

0 Min./ 1/ 2/ 3/ 4/ 5 Normal/ 6/ 7/ 8/ 9 Max.

- **Default:** 5 Normal

## Stream

### **[Stream(1)]**

Select “On” or “Off” to determine whether or not to activate the VIQS function for the transmitted (Stream(1)) images.

The VIQS (Stream(1)) images can be confirmed with the [Confirm] button.

- **Default:** Off

### **[Stream(2)]**

Select “On” or “Off” to determine whether or not to activate the VIQS function for the transmitted (Stream(2)) images.

The VIQS (Stream(2)) images can be confirmed with the [Confirm] button.

- **Default:** Off

### **[Stream(3)]**

Select “On” or “Off” to determine whether or not to activate the VIQS function for the transmitted (Stream(3)) images.

The VIQS (Stream(3)) images can be confirmed with the [Confirm] button.

- **Default:** Off

### **IMPORTANT**

- After the VIQS setting is set to “On”, the VIQS area may move out of alignment when the “Image capture mode” setting on the [Image] tab of the “Image” page is changed. Make sure to check the VIQS setting after changing the “Image capture mode” setting.

### **Note**

- Refer to “2.5.4.7 Configure the VIQS area” for setting procedure of the VIQS area.
- When “Off” is selected for “Stream transmission” of the applicable stream, the stream selection cannot be changed.

### 2.5.4.7 Configure the VIQS area

The VIQS area is specified by following the steps below.

1. Drag the mouse on the screen to specify the area (up to 8 areas).
  - The specified area is set to area “1(White)”, and the outline is displayed.
  - The areas are set in the area number order from number 1. The color next to the area number show the color of the corresponding outline.

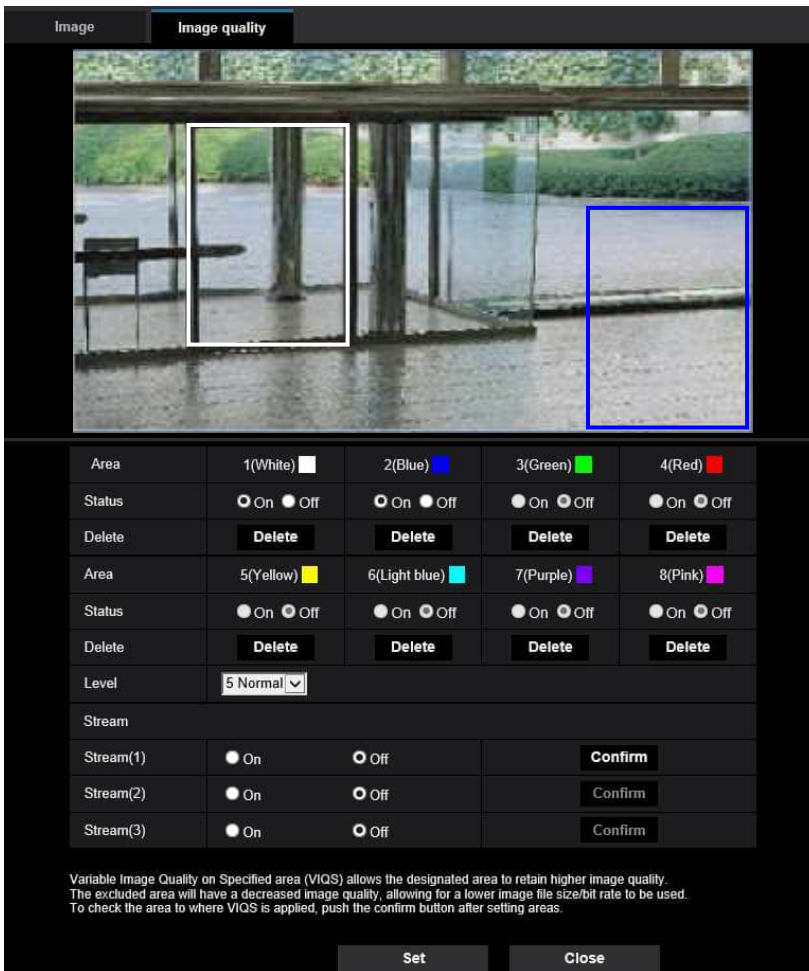

2. Configure the difference level in the image quality between specified areas and non-specified areas. The greater the difference level, the more the image quality of the non-specified area is reduced. This makes it possible to moderate the image data size.
3. Select On/Off to activate/deactivate a distributed image of “Stream(1)” – “Stream(3)”.
4. Click the [Set] button.
  - This unit is updated with the setting contents. Click the [Delete] button corresponding to the area to be deleted.
5. Click the [Confirm] button.
  - The image (“Stream(1)” – “Stream(3)”) that the [Confirm] button was pressed for is displayed. When a window is newly opened and about 3 seconds pass, the currently outputted bit rate can be confirmed with the configured VIQS.

#### IMPORTANT

- No setting contents are determined unless the [Set] button is clicked.

- To check the image after configuring VIQS, display an H.265 (or H.264) image on the “Live” page, or press the [Confirm] button under “Stream”.
- The outputted bit rate changes depending on the subject. Confirm the bit rates with actual subjects used when operating the camera.
- If the larger range is specified, the output bit rate increases. Check the current output bit rate to decide the area size.

## 2.6 Configure the alarm settings [Alarm]

The settings relating to alarm occurrences such as settings for the alarm action at an alarm occurrence or alarm images, the VMD area settings, SCD area settings and the alarm occurrence notification can be configured on this page.

The “Alarm” page has the [Alarm] tab, the [VMD area] tab, [SCD area] tab and the [Notification] tab.

### 2.6.1 Configure the settings relating to the alarm action [Alarm]

Click the [Alarm] tab on the “Alarm” page. (→For menu display and how to operate, refer to “2.2.1 How to display the setup menu”, “2.2.2 How to operate the setup menu”)

The settings relating to the alarm can be configured in this section. Refer to “2.6.2 Configure the settings relating to the camera action on alarm occurrence [Alarm]” for further information about the settings relating to the alarm images.



## Alarm

### [VMD alarm]

When clicking “VMD >>”, the [VMD area] tab of the “Alarm” page will be displayed. (→“2.6.4 Set the VMD areas [VMD area]”)

### [SCD alarm]

When clicking “SCD”, the [SCD area] tab will be displayed. (→“2.6.5 Configure the SCD settings [SCD area]”)

### [Command alarm]

Select “On” or “Off” to determine whether or not to receive the command alarm.

The command alarm is the function that provides notification of a TCP alarm notification from the other cameras. When “On” is selected, alarm actions will be performed between multiple cameras.

- **Default:** Off

### [Reception port]

Select a port number to be used to receive the command alarm.

- **Available range:** 1-65535
- **Default:** 8181

The following port numbers are unavailable since they are already in use.

20, 21, 23, 25, 42, 53, 67, 68, 69, 80, 110, 123, 161, 162, 443, 554, 995, 10669, 10670, 59000-61000

**[Alarm deactivation time]**

Configure the duration that detections won't be made after an alarm is detected. For example, by using this function you can prevent E-mail from being sent too often when E-mail notifications are configured to be sent to tablet device when an alarm is detected.

5-600s

- **Default:** 5s

**Note**

- The duration that alarm detections are not made can be managed for each type of alarm. For example, during the time when detections for command alarms are not made, detections for VMD alarm can be made.

## 2.6.2 Configure the settings relating to the camera action on alarm occurrence [Alarm]

Click the [Alarm] tab on the "Alarm" page. (→For menu display and how to operate, refer to "2.2.1 How to display the setup menu", "2.2.2 How to operate the setup menu")

The settings related to the camera action on alarm can be configured in this section.

Camera action on alarm	
Alarm E-mail notification	<a href="#">E-mail server &gt;&gt;</a>
Alarm image recording(SD memory card)	<a href="#">SD memory card setup &gt;&gt;</a>
TCP alarm notification	<a href="#">TCP alarm notification &gt;&gt;</a>
HTTP alarm notification	<a href="#">HTTP alarm notification setup &gt;&gt;</a>
SNMP transmission upon alarm detection	<a href="#">To SNMP setting</a>

**[Alarm E-mail notification]**

Click "E-mail server >>" to display the setup menu that can configure the settings relating to E-mail notification when an alarm occurs. The setup menu will be displayed in a newly opened window. (→"2.6.2.1 Configure settings relating to alarm E-mail notifications")

**[Alarm image recording(SD memory card)]**

Click "SD memory card setup >>" to display the setup menu that can configure the settings relating to recording images on an SD memory card when an alarm occurs. The setup menu will be displayed in a newly opened window. (→"2.6.2.2 Configure settings relating to recording to an SD memory card when an alarm occurs")

**[TCP alarm notification]**

Click "TCP alarm notification >>" to display the setup menu that can configure the settings relating to transmitting TCP alarm notification when an alarm occurs. The setup menu will be displayed in a newly opened window. (→"2.6.2.3 Configure settings relating to TCP alarm notification when an alarm occurs")

**[HTTP alarm notification]**

Click "HTTP alarm notification setup >>" to display the setup menu that can configure the settings relating to transmitting HTTP alarm notifications when an alarm occurs. The setup menu will be displayed in a newly opened window. (→"2.6.2.4 Configure settings relating to HTTP alarm notification when an alarm occurs")

**[SNMP transmission upon alarm detection]**

Click “To SNMP setting” to display the setup menu that can configure the settings relating to SNMP transmission when an alarm occurs. The setup menu will be displayed in a newly opened window. (→“2.6.2.4 Configure settings relating to HTTP alarm notification when an alarm occurs”)

**2.6.2.1 Configure settings relating to alarm E-mail notifications**

Click “E-mail server >>” of “Camera action on alarm” on the [Alarm] tab of the “Alarm” page. (→“2.6.2 Configure the settings relating to the camera action on alarm occurrence [Alarm]”)

E-mail notification	
E-mail notification	<input type="radio"/> On <input type="radio"/> Off
SMTP server address	<input type="text"/> Example of entry: 192.168.0.10
SMTP port	<input type="text"/> 25 (1-65535)
POP server address	<input type="text"/> Example of entry: 192.168.0.10
Authentication	Type <input type="radio"/> None <input type="radio"/> POP before SMTP <input type="radio"/> SMTP
	User name <input type="text"/>
	Password <input type="text"/>
Sender's E-mail address	<input type="text"/>
SSL	<input type="radio"/> On <input type="radio"/> Off
Destination of notification	
Destination E-mail address	
Address 1	<input type="text"/> Delete <input type="checkbox"/> VMD <input type="checkbox"/> SCD <input type="checkbox"/> Command alarm <input type="checkbox"/> Diag.
Address 2	<input type="text"/> Delete <input type="checkbox"/> VMD <input type="checkbox"/> SCD <input type="checkbox"/> Command alarm <input type="checkbox"/> Diag.
Address 3	<input type="text"/> Delete <input type="checkbox"/> VMD <input type="checkbox"/> SCD <input type="checkbox"/> Command alarm <input type="checkbox"/> Diag.
Address 4	<input type="text"/> Delete <input type="checkbox"/> VMD <input type="checkbox"/> SCD <input type="checkbox"/> Command alarm <input type="checkbox"/> Diag.
E-mail subject(Alarm)	<input type="checkbox"/> Use the camera title <input type="checkbox"/> Cause of alarm <input type="text"/>
E-mail subject(Diag.)	<input type="checkbox"/> Use the camera title <input type="text"/> (Information)
E-mail body(Alarm)	<input checked="" type="checkbox"/> Cause of alarm <input checked="" type="checkbox"/> Occurrence time <input type="text"/> The %p% alarm was occurred at %t%
Set Close	

Refer to “2.8.2.1 Configure the settings related to sending E-mails” for information on configuration for these settings.

## 2.6.2.2 Configure settings relating to recording to an SD memory card when an alarm occurs

Click “SD memory card setup >>” of “Camera action on alarm” on the [Alarm] tab of the “Alarm” page.  
(→“2.6.2 Configure the settings relating to the camera action on alarm occurrence [Alarm]”)

Operating mode	
SD memory card	<input type="radio"/> Use <input type="radio"/> Not use
Remaining capacity notification	50% ▾
Overwrite	<input type="radio"/> On <input type="radio"/> Off
Recording stream	
Recording format	Stream(1) ▾ (H.265/1920x1080)
Save trigger	Alarm input ▾
	<input checked="" type="checkbox"/> VMD <input checked="" type="checkbox"/> SCD <input checked="" type="checkbox"/> Command alarm
Stream recording(Alarm)	
Pre alarm (recording) duration	Off ▾
Post alarm (recording) duration	30s ▾
<input type="button" value="Set"/> <input type="button" value="Close"/>	

Refer to “2.4.2 Configure the settings relating to the SD memory card [SD memory card]” for information on configuration for these settings.

### 2.6.2.3 Configure settings relating to TCP alarm notification when an alarm occurs

Click “TCP alarm notification >>” of “Camera action on alarm” on the [Alarm] tab of the “Alarm” page.  
 (→“2.6.2 Configure the settings relating to the camera action on alarm occurrence [Alarm]”)

TCP alarm notification			
TCP alarm notification	<input checked="" type="radio"/> On	<input type="radio"/> Off	
Additional alarm data	<input checked="" type="radio"/> On	<input type="radio"/> Off	
Destination port	1618 (1-65535)		
Retry times	▼		
Destination of notification			
	Alarm	Diag.	Destination server address
Address 1	<input type="checkbox"/>	<input type="checkbox"/>	<input type="text"/>
Notification per VMD area	<input checked="" type="radio"/> On	<input type="radio"/> Off	Alarm area No. ▼
Address 2	<input type="checkbox"/>	<input type="checkbox"/>	<input type="text"/>
Notification per VMD area	<input checked="" type="radio"/> On	<input type="radio"/> Off	Alarm area No. ▼
Address 3	<input type="checkbox"/>	<input type="checkbox"/>	<input type="text"/>
Notification per VMD area	<input checked="" type="radio"/> On	<input type="radio"/> Off	Alarm area No. ▼
Address 4	<input type="checkbox"/>	<input type="checkbox"/>	<input type="text"/>
Notification per VMD area	<input checked="" type="radio"/> On	<input type="radio"/> Off	Alarm area No. ▼
Address 5	<input type="checkbox"/>	<input type="checkbox"/>	<input type="text"/>
Notification per VMD area	<input checked="" type="radio"/> On	<input type="radio"/> Off	Alarm area No. ▼
Address 6	<input type="checkbox"/>	<input type="checkbox"/>	<input type="text"/>
Notification per VMD area	<input checked="" type="radio"/> On	<input type="radio"/> Off	Alarm area No. ▼
Address 7	<input type="checkbox"/>	<input type="checkbox"/>	<input type="text"/>
Notification per VMD area	<input checked="" type="radio"/> On	<input type="radio"/> Off	Alarm area No. ▼
Address 8	<input type="checkbox"/>	<input type="checkbox"/>	<input type="text"/>
Notification per VMD area	<input checked="" type="radio"/> On	<input type="radio"/> Off	Alarm area No. ▼
Example of entry: 192.168.0.10			
Set		Close	

Refer to “2.6.7.1 Configure the settings relating to TCP alarm notification” for information on configuration for these settings.

## 2.6.2.4 Configure settings relating to HTTP alarm notification when an alarm occurs

Click “HTTP alarm notification setup >>” of “Camera action on alarm” on the [Alarm] tab of the “Alarm” page. (→“2.6.2 Configure the settings relating to the camera action on alarm occurrence [Alarm]”)

HTTP alarm notification		Alarm	
Address 1	<input type="checkbox"/>	<input type="text" value="http://"/>	<input type="button" value="Delete"/>
User name		<input type="text"/>	
Password		<input type="text"/>	
Notification data		<input type="text" value="/cgi-bin/comalarm.cgi?CMD=01"/>	
Address 2	<input type="checkbox"/>	<input type="text" value="http://"/>	<input type="button" value="Delete"/>
User name		<input type="text"/>	
Password		<input type="text"/>	
Notification data		<input type="text" value="/cgi-bin/comalarm.cgi?CMD=01"/>	
Address 3	<input type="checkbox"/>	<input type="text" value="http://"/>	<input type="button" value="Delete"/>
User name		<input type="text"/>	
Password		<input type="text"/>	
Notification data		<input type="text" value="/cgi-bin/comalarm.cgi?CMD=01"/>	
Address 4	<input type="checkbox"/>	<input type="text" value="http://"/>	<input type="button" value="Delete"/>
User name		<input type="text"/>	
Password		<input type="text"/>	
Notification data		<input type="text" value="/cgi-bin/comalarm.cgi?CMD=01"/>	
Address 5	<input type="checkbox"/>	<input type="text" value="http://"/>	<input type="button" value="Delete"/>
User name		<input type="text"/>	
Password		<input type="text"/>	
Notification data		<input type="text" value="/cgi-bin/comalarm.cgi?CMD=01"/>	
		<input type="button" value="Set"/>	<input type="button" value="Close"/>

Refer to “2.6.7.2 Configure the settings relating to HTTP alarm notification” for information on configuration for these settings.

### 2.6.2.5 Configure settings relating to SNMP transmissions of alarm images

Click “To SNMP setting” of “Camera action on alarm” on the [Alarm] tab of the “Alarm” page. (→“2.6.2 Configure the settings relating to the camera action on alarm occurrence [Alarm]”)

SNMP agent setting		
SNMP version	SNMPv1/v2	
SNMPv1/v2	Community	<input type="text"/>
	Manager address	<input type="text"/>
SNMPv3	User name (1 to 32 characters)	<input type="text"/>
	Authentication	<input type="radio"/> MD5 <input type="radio"/> SHA1
	Encryption method	<input type="radio"/> DES <input type="radio"/> AES
	Password (8 to 16 characters)	<input type="text"/>
SNMPv2-MIB system setting		
System name	<input type="text"/>	
Location	<input type="text"/>	
Contact	<input type="text"/>	
SNMP trap setting	<input type="radio"/> On <input type="radio"/> Off	
Destination of Trap	Address	<input type="text"/>
	Port number	<input type="text"/> (1-65535)
SNMPv2c	Community	<input type="text"/>
Trap setting		
	Enable/Disable	Trap string
SNMP Generic trap	<input type="checkbox"/> coldStart	<input type="text"/> cold start
	<input type="checkbox"/> linkUp	<input type="text"/> linkup
	<input type="checkbox"/> authenticationFailure	<input type="text"/> auth error
Alarm	<input type="checkbox"/> Terminal 1	<input type="text"/> terminal alarm 1
	<input type="checkbox"/> Terminal 2	<input type="text"/> terminal alarm 2
	<input type="checkbox"/> Terminal 3	<input type="text"/> terminal alarm 3
	<input type="checkbox"/> VMD	<input type="text"/> VMD alarm
	<input type="checkbox"/> Command alarm	<input type="text"/> cmd
SD memory card	<input type="checkbox"/> Diag.	<input type="text"/> sd alarm
<input type="button" value="Set"/>		<input type="button" value="Close"/>

Refer to “2.8.2.6 Configure the settings relating to SNMP” for information on configuration for these settings.

### 2.6.3 Configure the VMD settings [VMD area]

Click the [VMD area] tab on the “Alarm” page. (→For menu display and how to operate, refer to “2.2.1 How to display the setup menu”, “2.2.2 How to operate the setup menu”)

The video motion detection areas can be set on this page.

Up to 4 areas can be set. When motion is detected in the set area, it will be regarded as an alarm.

**IMPORTANT**

- The alarm occurrence indication button (→“1.1.2 About the “Live” page”) will be displayed when motion is detected by the VMD function.
- The alarm occurrence indication button will be displayed at an SCD alarm occurrence or when receiving a command alarm as well.
- Depending on the network environment, notification may be delayed even when “Real time” is selected for “Status update mode” on the [Basic] tab of the “Basic” page (→“2.4.1 Configure the basic settings [Basic]”).
- After configuring the VMD area, the VMD area may move out of alignment when “Image capture mode” of the [Image] tab is changed. Make sure to check the VMD area after changing the “Image capture mode” setting.
- Note that VMD does not function in the area where the privacy zone is set.
- The motion detection function is not the dedicated function to prevent thefts, fires, etc. We are not responsible for any accidents or damages that may occur.
- Be aware that a VMD alarm may occur due to changes in the brightness of the whole image depending on the status of the object when “On” is selected for “Intelligent auto”.  
In such a case, set either of the following:
  - Select “On” for “Light detection control” of VMD.
  - Move the slider of “Detection sensitivity” of the VMD area in the “-” direction.

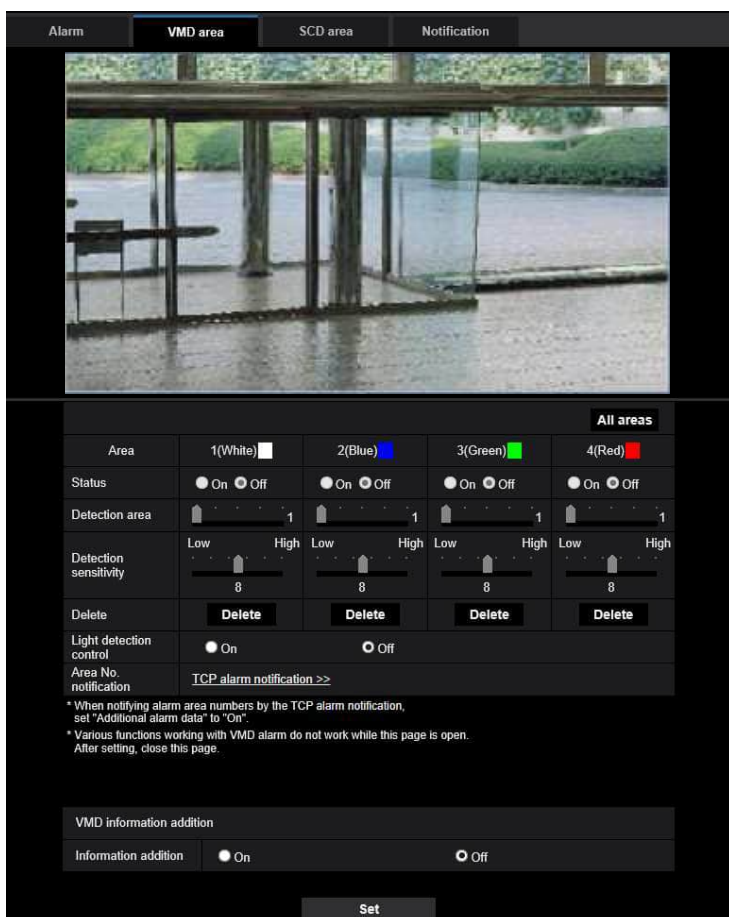
**[Area]**

When selecting a VMD area in the screen, it will be numbered as area 1. (Subsequent areas will be numbered in the order of selection.)

### [All areas] button

When the [All areas] button is clicked, the whole area will become the VMD area, and "1(White)" will be automatically applied to "Area".

### [Status]

Select "On" or "Off" to determine whether or not to perform video motion detection.

- **On:** Performs video motion detection.
- **Off:** Does not perform video motion detection.
- **Default:** Off

### [Detection area]

Adjust the size of the VMD area using the slider. The smaller the selected value is, the higher the sensitivity of VMD area becomes. The current value (1-10) will be displayed on the right of the slider.

- **Default:** 1

### [Detection sensitivity]

Adjust the sensitivity of motion detection in the VMD area using the slider. The settings can be configured for each area individually. The larger the value is set, the higher the sensitivity level becomes.

The current value (1 (low) - 15 (high)) will be displayed below the slider.

- **Default:** 8

### [Delete] button

Click the [Delete] button corresponding to the area to be deleted. The outline of the selected area will be deleted.

### [Light detection control]

Select "On" or "Off" to determine whether or not to suspend video motion detection affected by brightness change such as by a dimming level control.

- **Default:** Off

### **IMPORTANT**

- "Light detection control" may not work when brightness change is too small.
- When "On" is selected for "Light detection control", the video motion detection may not be performed even when detecting a subject moving over the whole screen.

### [Area No. notification]

When "TCP alarm notification >>" is clicked, the [Notification] tab of the "Alarm" page will be displayed. (→"2.6.7 Configuration of the settings relating to alarm notification [Notification]")

## VMD information addition

### [Information addition]

Select "On" or "Off" to determine whether or not to add VMD information to superimposed image data. The VMD information can be searched by some of our network disk recorders. Refer to the operating instructions of the connected devices for further information about the functions and settings.

- **Default:** Off

## 2.6.4 Set the VMD areas [VMD area]

Set the areas to activate the VMD function.

**IMPORTANT**

- During change of setting in the setup menu, no alarm will be detected. After setup is complete, close the setup menu.
1. Set the video motion detection area by dragging the mouse on the screen.
    - The designated area will become the VMD area “1(White)” and the outline will be displayed. When 2 - 4 VMD areas are set, each area will be numbered in order. The areas will be identified by the respective outline colors. The “Status” of the outline to be set for the area will become “On”.

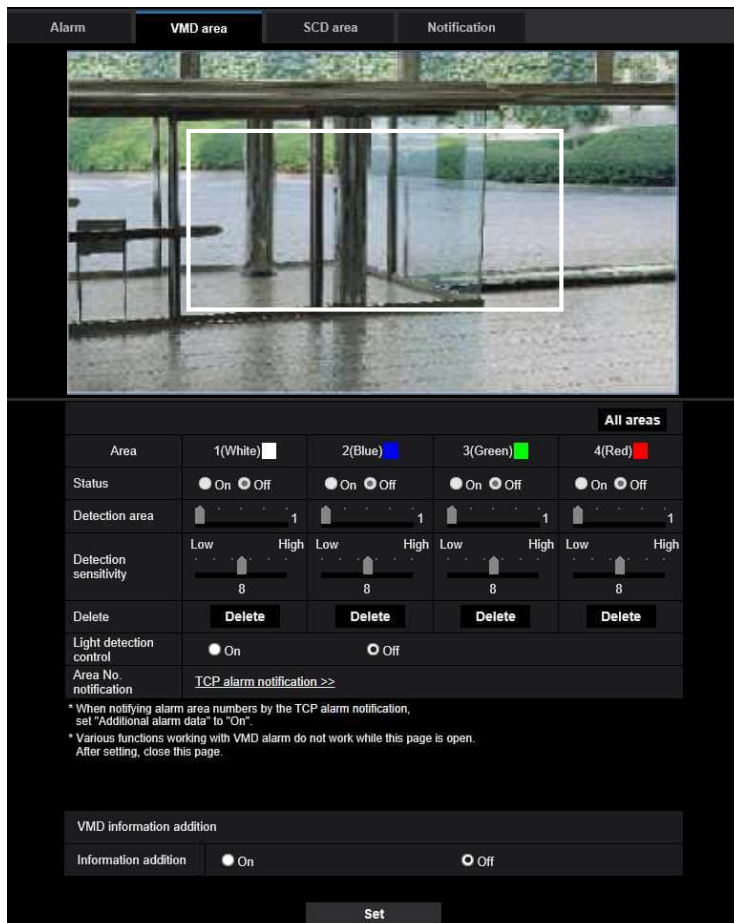

2. Adjust “Detection area” and “Detection sensitivity” using the slider. Refer to “2.6.3 Configure the VMD settings [VMD area]” for further information about the “Detection sensitivity” and “Detection area”. The currently displayed area and its detection sensitivity will be displayed in the “Detection area” section. Change areas and the settings of “Detection area” and “Detection sensitivity” as necessary.
3. Click the [Set] button after completing the settings.

**IMPORTANT**

- The setting will not be applied unless the [Set] button is clicked.
4. To invalidate the VMD area, click the [Set] button after selecting “Off” for “Status” of the VMD area to be invalidated.
    - The outline of the invalidated VMD area will turn to a dotted line. When the VMD area is invalidated, no alarm will occur even when a motion can be recognized in the area.
  5. To delete the VMD area, click the [Delete] button corresponding to the area to be deleted.
    - The outline of the respective VMD area will disappear.

6. Click the [Set] button.  
→ The edited settings will be applied.

### 2.6.5 Configure the SCD settings [SCD area]

Click the [SCD area] tab on the “Alarm” page. (→For menu display and how to operate, refer to “2.2.1 How to display the setup menu”, “2.2.2 How to operate the setup menu”)

By configuring SCD (scene change detection) setting, it is possible to issue an alarm when a camera is covered with something or the camera direction is changed to shoot a different subject.

The detection area using the SCD function can be set on this section. Up to 1 area can be set. When a shooting subject is changed in the set area, it will issue an alarm.

#### **IMPORTANT**

- Since it takes time for necessary learning in the following period, the SCD will not function for a while.
  - Right after the SCD is set
  - After the power of this product is turned on
  - After a scene change is detected
- The alarm occurrence indication button (→“1.1.2 About the “Live” page”) will be displayed when scene change is detected by the SCD function.
- The alarm occurrence indication button will be displayed at a VMD alarm occurrence or when receiving a command alarm as well.
- Depending on the network environment, notification may be delayed even when “Real time” is selected for “Status update mode” on the [Basic] tab of the “Basic” page. (→“2.4.1 Configure the basic settings [Basic]”)
- After configuring the SCD area, the SCD area may move out of alignment when “Image capture mode” of the [Image] tab is changed. Make sure to check the SCD area after changing the “Image capture mode” setting.
- In the following cases, scene change may not be detected.
  - Only a part of the shooting area is covered or the covered object can be seen.
  - Subjects look alike each other before and after the camera direction has been changed.
  - In the area where the privacy zone is set.
- The SCD function is not the dedicated function to prevent thefts, fires, etc. We are not responsible for any accidents or damages that may occur.
- When “Detection time” of “SCD area” is shorter than “Dwell time” of “Day & Night(IR)”, a scene change detection (SCD) may be activated at the time when an image is switched to BW. It can be improved by setting “Dwell time” of “Day & Night(IR)” shorter than “Detection time” of “SCD area”.

- When the image color is close to monochrome, detection of SCD alarms may become difficult. When no alarms is detected, increase “Detection sensitivity” or set smaller “Detection area”.

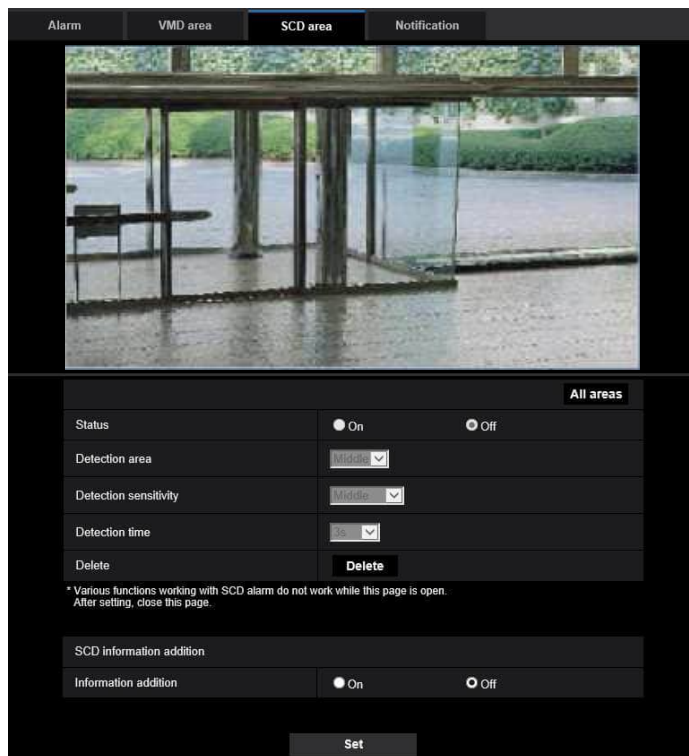

### [Status]

Select “On” or “Off” to determine whether or not to perform SCD.

- **On:** Performs SCD.
- **Off:** Does not perform SCD.
- **Default:** Off

### [Detection area]

Set the detection ratio “Small”, “Middle” or “Large”, which specifies how much of change in the area set in [SCD area] to be detected.

- **Default:** Middle

### [Detection sensitivity]

Adjust the SCD sensitivity in the SCD area and select from “Very Low”, “Low”, “Middle”, or “High”.

- **Default:** Middle

### [Detection time]

The SCD function issues an alarm when the scene change continues for a specified time of period.  
3s/5s/10s/30s/1min

- **Default:** 3s

### [All areas]

Set the entire image in the SCD area.

### [Delete] button

Click the [Delete] button to be deleted the selected area.

### SCD information addition

#### [Information addition]

Select “On” or “Off” to determine whether or not to add SCD information to superimposed image data.

- **Default:** Off

#### Note

- SCD information will not be used on our network disk recorders. (As of September 2021)

### 2.6.6 Set the SCD areas [SCD area]

Set the areas to activate the SCD (scene change detection) function.

#### IMPORTANT

- During change of setting in the setup menu, no alarm will be detected. After setup is complete, close the setup menu.
1. Set the SCD area by dragging the mouse on the screen.  
→ The designated area will become the SCD area and the outline of white color will be displayed. The “Status” will become “On”.

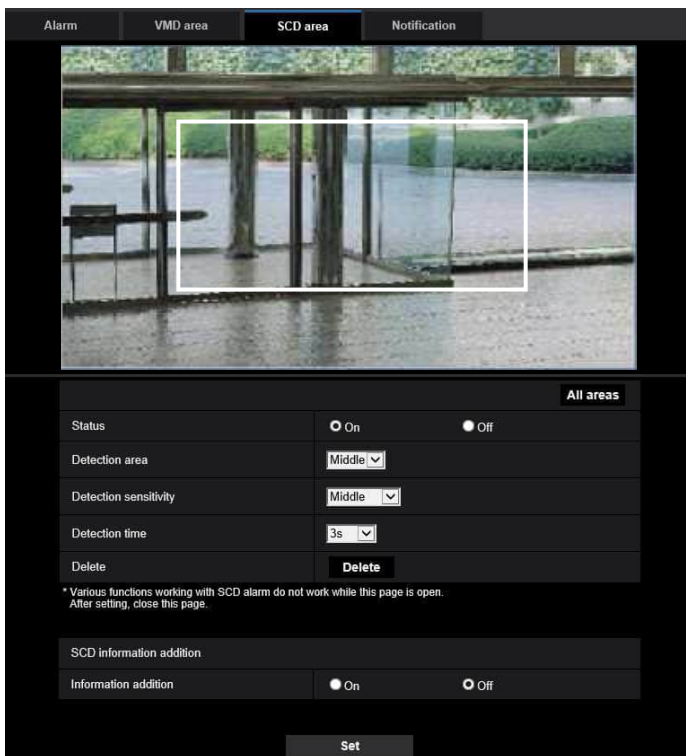

2. Adjust “Detection area” and “Detection sensitivity” selecting the pull-down menu.  
Refer to “2.6.5 Configure the SCD settings [SCD area]” for further information about the “Detection sensitivity” and “Detection area”.  
Change areas and the settings of “Detection area” and “Detection sensitivity” as necessary.
3. Click the [Set] button after completing the settings.

#### IMPORTANT

- The setting will not be applied unless the [Set] button is clicked.

4. To invalidate the SCD area, click the [Set] button after selecting “Off” for “Status”.  
→ The outline of the invalidated SCD area will turn to a dotted line. When the SCD area is invalidated, no alarm will occur even when a motion can be recognized in the area.
5. To delete the SCD area, click the [Delete] button.  
→ The outline of the SCD area will disappear.
6. Click the [Set] button.  
→ The edited settings will be applied.

## 2.6.7 Configuration of the settings relating to alarm notification [Notification]

Click the [Notification] tab on the “Alarm” page. (→For menu display and how to operate, refer to “2.2.1 How to display the setup menu”, “2.2.2 How to operate the setup menu”)

The settings relating to TCP alarm notification and HTTP alarm notification can be configured in this section.

### 2.6.7.1 Configure the settings relating to TCP alarm notification

### TCP alarm notification

**[TCP alarm notification]**

Select “On” or “Off” to determine whether or not to provide notification by TCP alarm notification according to the settings for the “Alarm” and “Diag.” checkboxes of “Destination of notification” below.

- When an alarm is detected (“Alarm”)
- When a notification of the remaining capacity of the SD memory card has been provided (“Diag.”)
- When the SD memory card has become full (“Diag.”)

- When the SD memory card cannot be recognized (“Diag.”)
- **Default:** Off

**Note**

- When “On” is selected, notification of the alarm occurrence will be provided to the registered destination server addresses in order (to IP address 1 first, to IP address 8 last).  
\*Only the destination with the checked [Alarm] checkbox.

**[Additional alarm data]**

Determine whether or not to send notifications for VMD alarm detection area numbers with the TCP alarm notification by selecting On/Off.

- **Default:** Off

**[Destination port]**

Select a destination port for the TCP alarm notification from the following.

- **Available range:** 1 - 65535
- **Default:** 1818

The following port numbers are unavailable since they are already in use.

20, 21, 23, 25, 42, 53, 67, 68, 69, 80, 110, 123, 161, 162, 443, 995, 10669, 10670

**[Retry times]**

Select a retry time for the TCP alarm notification.

- **Available range:** 0-30
- **Default:** 2

**Destination of notification****[Address 1] - [Address 8]**

Enter the destination IP address or host name of the TCP alarm notification from the following. Up to 8 destination server addresses can be registered.

- **[Alarm] checkbox:** When the checkbox is checked, the TCP alarm notification will be provided upon an alarm occurrence.
- **[Diag.] checkbox:** When the checkbox is checked, notification using TCP alarm notification will be provided in the following cases.
  - When notification of the remaining capacity of the SD memory card has been provided
  - When the SD memory card has become full
  - When the SD memory card cannot be recognized
- **[Destination server address]:** Enter the destination server address or host name.
  - **Available characters:** Alphanumeric characters, the colon (:), the period (.), the underscore (\_), and the hyphen (-).

To delete the registered destination server address, click the [Delete] button respective to the desired destination server address.

**[Notification per VMD area]**

Select “On” or “Off” to determine whether or not to set “Notification per VMD area”.

If “Notification per VMD area” is turned “On”, an alarm is notified only when “Alarm area No.” matches “Alarm area” configured by “VMD alarm”. Alarm notifications other than “VMD alarm” are not implemented. When using “Notification per VMD area”, select “On” for “Status” of the alarm area in VMD.

- **Default:** Off

**[Alarm area No.]**

- **Available range:** 1-4

- **Default:** 1

### **IMPORTANT**

- When entering the host name of the “Destination server address”, the DNS settings on the [Network] tab of the “Network” page must be configured. (→“2.8.1 Configure the network settings [Network]”)
- Confirm that the destination IP addresses are registered correctly. When a registered destination does not exist, notification may be delayed.

## 2.6.7.2 Configure the settings relating to HTTP alarm notification

HTTP alarm notification		Alarm	
Address 1	<input type="checkbox"/>	http://	Delete
User name			
Password			
Notification data		/cgi-bin/comalarm.cgi?CMD=01	
Address 2	<input type="checkbox"/>	http://	Delete
User name			
Password			
Notification data		/cgi-bin/comalarm.cgi?CMD=01	
Address 3	<input type="checkbox"/>	http://	Delete
User name			
Password			
Notification data		/cgi-bin/comalarm.cgi?CMD=01	
Address 4	<input type="checkbox"/>	http://	Delete
User name			
Password			
Notification data		/cgi-bin/comalarm.cgi?CMD=01	
Address 5	<input type="checkbox"/>	http://	Delete
User name			
Password			
Notification data		/cgi-bin/comalarm.cgi?CMD=01	

**Set**

## HTTP alarm notification

### [Address 1] - [Address 5]

Enter the destination IP address or host name of the HTTP alarm notification. Up to 5 destination server addresses can be registered.

- **Available characters:** Alphanumeric characters, the colon (:), the period (.), the underscore (\_), and the hyphen (-).
- **Default:** http://

### Example of entry:

“http://IP address of the HTTP server + : (colon) + port number” or “http://Host name: (colon) + port number”  
“https://IP address of the HTTP server + : (colon) + port number” or “https://Host name: (colon) + port number”

### [Alarm] checkbox

When the checkbox is checked, the HTTP alarm notification will be provided upon an alarm occurrence.

**[Delete] button**

When this button is clicked, all configured information, including the address, user name, password, and notification data, will be deleted.

**[User name]**

Enter the user name (login name) to access the HTTP server.

- **Available number of characters:** 0 - 63 characters
- **Unavailable characters:** " & ; ; \

**[Password]**

Enter the password to access the HTTP server.

- **Available number of characters:** 0 - 63 characters
- **Unavailable characters:** " &

**Note**

- "Basic" or "Digest" authentication will be performed when receiving authentication request of the HTTP server.

**[Notification data]**

Enter the notification data to add after the destination HTTP server addresses set in [Address 1] - [Address 5].

- **Available characters:** Alphanumeric characters
- **Default:** /cgi-bin/comalarm.cgi?CMD=01

**Note**

- When the HTTP alarm function is enabled, leakage of the HTTP server authentication information (user name and password) may occur in the network at the time of HTTP alarm notification.
- For "Address 1" to "Address 5", a total of 256 characters can be entered for the address (including "http://") and "Notification data".
- Make sure to enter a slash (/) as the first character for "Notification data".
- If the HTTP alarm notification fails, information about the failure will be added to the system log.
- Even if the [Set] button is clicked after deleting the contents of "Notification data", "/cgi-bin/comalarm.cgi?CMD=01" will be set.
- HTTPS cannot be used.

**<Example>**

When http://192.168.0.100 is set for the address and /cgi-bin/comalarm.cgi?CMD=01 is set for "Notification data", an HTTP alarm notification such as http://192.168.0.100/cgi-bin/comalarm.cgi?CMD=01 will be executed.

## 2.7 Configure the settings relating to the authentication [User mng.]

The settings relating to the authentication such as users and PCs restrictions for accessing the camera with a PC or a mobile terminal/tablet device can be configured on the “User mng.” page.  
The “User mng.” page has 3 tabs; the [User auth.] tab, the [Host auth.] tab, and [IEEE 802.1X] tab.

### 2.7.1 Configure the settings relating to the user authentication [User auth.]

Click the [User auth.] tab on the “User mng.” page. (→For menu display and how to operate, refer to “2.2.1 How to display the setup menu”, “2.2.2 How to operate the setup menu”)

The settings relating to the authentication of users who can access this camera from the PC or a mobile terminal/tablet device can be configured on this page. Up to 24 users can be registered.

**Note**

- When user authentication has failed to pass (authentication error) 8 times within 30 seconds using the same IP address (PC), access to the unit will be denied for a while.

User auth. Host auth. IEEE 802.1X

User auth.  On  Off

Guest User  Use  Not use

Authentication Digest

Set

User name registration --New registration-- Change Delete

User name (1 to 32 characters)

Password (8 to 32 characters)

Retype password

Access level 3. Live only

Set

Note:

(1) Distinguish between upper- and lower cases.

(2) Entry of the following is not allowed as a user name: 2-byte characters, and 1-byte symbols " & ; \

(3) Entry of the following is not allowed as a password: 2-byte characters, and 1-byte symbols " &

(4) For the password, use three or more types of characters from upper- and lowercase alphabetic characters, numbers, and symbols.

(5) Keep the user name and password at hand so as not to lose.

(6) It is recommended to change the password periodically.

(7) Set the password which does not include the user name.

Access level	Camera control	Live only	Guest User
Live view selectable	<input checked="" type="checkbox"/>	<input type="checkbox"/>	<input type="checkbox"/>
Refresh Rate	<input checked="" type="checkbox"/>	<input type="checkbox"/>	<input type="checkbox"/>
Snap shot	<input checked="" type="checkbox"/>	<input type="checkbox"/>	<input type="checkbox"/>
Playback of recording (Log disp.)	<input checked="" type="checkbox"/>	<input type="checkbox"/>	<input type="checkbox"/>
Manual rec./Delete rec.	<input checked="" type="checkbox"/>	<input type="checkbox"/>	<input type="checkbox"/>
Brightness	<input checked="" type="checkbox"/>	<input type="checkbox"/>	<input type="checkbox"/>

Set

**[User auth.]**

Select “On” or “Off” to determine whether or not to authenticate the users.

- **Default:** On

**[Guest User]**

Select whether or not to set Guest User. If you select “Use”, you can set which functions are available or unavailable for guest users for whom user authentication has not been performed.

- **Default:** Not use

**[Authentication]**

Set the user authentication method.

- **Digest or Basic:** Uses “Digest or Basic” authentication.
- **Digest:** Uses “Digest” authentication.
- **Basic:** Uses “Basic” authentication.
- **Default:** Digest

### **Note**

- To enhance the security, it is recommended to select “Digest” for “Authentication method”. If “Digest or Basic” or “Basic” is selected, leakage of the user name and the password may occur.
- When the [Authentication] setting has been changed, close the web browser, and then access the camera again.
- About the system devices (our network disk recorder and others)  
For the model No. and the firmware version of applicable products, refer to our support web site <Control No.: C0701>.

### **[User name registration]**

At the time of new registration, register a new user name in [User name]. Click [▼] in “User name registration” to view registered users. Registered users are displayed as “Registered user name [Access level]”. (Example: admin [1])

If you click the [Change] button on the right, the selected user will be displayed in [User name], and you can change the password. By clicking the [Delete] button on the right, you can delete the selected user.

### **[User name (1 to 32 characters)]**

Enter a user name.

- **Available number of characters:** 1 - 32 characters
- **Unavailable characters:** " & ; \
- **Default:** None (blank)

### **Note**

- When the user name already in use is entered and the [Set] button is clicked, the respective user information will be overwritten.

### **[Password (8 to 32 characters)] [Retype password]**

Enter a password.

- **Available number of characters:** 8 - 32 characters
- **Unavailable characters:** " &
- **Default:** None (blank)

### **Note**

- Distinguish between upper- and lower cases.
- For the password, use three or more types of characters from upper- and lowercase alphabetic characters, numeric characters, and symbols.
- Set the password which does not include the user name.

### **[Access Level]**

Select the access level of the user from the following.

- **1. Administrator:** Allowed all available operations of the camera.
- **2. Camera control:** Allowed to control the camera. Functions selected for “Access level” can be operated.
- **3. Live only:** Allowed to display live view. Functions selected for “Access level” can be operated.
- **Default:** 3. Live only

### **[Access level]**

Select the available functions based on the user access level (camera control, live view, guest user).

- **Default:**

- Camera control: All are checked
- Live only: All are not checked
- Guest User: All are not checked

**Note**

- **If you have set “User authentication” to “Off”, and “Guest User” to “Not use”:**  
The “Access Level” item cannot be set. And, while all the live operation buttons are displayed, the [Setup] buttons require authentication.
- **If you have set “User authentication” to “Off”, and “Guest User” to “Use”:**  
You can set the items for “Guest User”.
- **If you have set “User authentication” to “On”:**  
You cannot set the items for “Guest User”.

You can set the following functions.

Live view selectable	Selecting an image displayed in the live view setting permissions
Refresh Rate	JPEG format image refresh interval setting permissions (→“Stream information display”)
Snap shot	Snap shot operation permissions (→“Snap shot button”)
Playback of recording (Log disp.)	Log operation permissions (→“[Log/Play] button”)
Manual rec./Delete rec.	SD memory card save/delete permissions (→“[Rec. on SD] button”)
Brightness	Brightness setting permissions (→“[Brightness] buttons”)

## 2.7.2 Configure the settings relating to the host authentication [Host auth.]

Click the [Host auth.] tab on the “User mng.” page. (→For menu display and how to operate, refer to “2.2.1 How to display the setup menu”, “2.2.2 How to operate the setup menu”)

The restriction settings of PCs (IP address) from accessing the camera can be configured on this page.

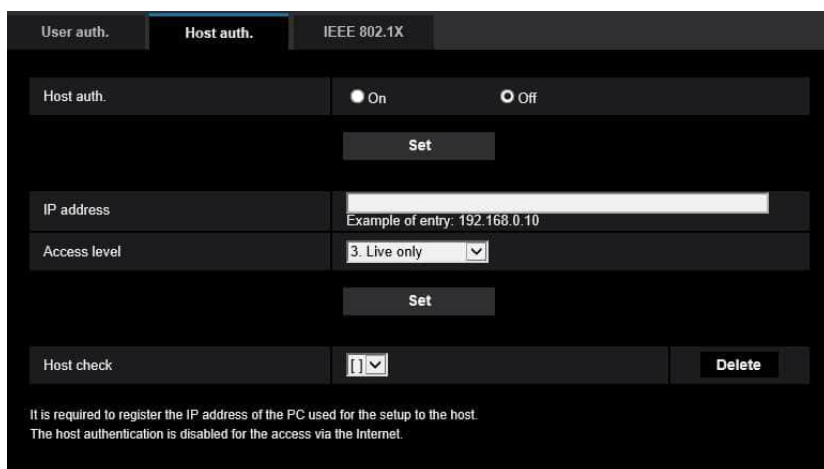
**[Host auth.]**

Select “On” or “Off” to determine whether or not to authenticate the host.

- **Default:** Off

### **IMPORTANT**

- Set "Host auth." to "On" after registering the IP address of the PC.
- If "On" is selected for "User auth.", the user authentication is required regardless of the host authentication settings.

### **[IP address]**

Enter the IP address of the PC to be allowed to access the camera. Host name cannot be entered for the IP address.

### **Note**

- When "IP address/subnet mask" is entered, it is possible to restrict PCs in each subnet. For example, when "192.168.0.1/24" is entered and "2. Camera control" is selected for the access level, the PCs whose IP address is between "192.168.0.1" - "192.168.0.254" can access the camera with the access level "2. Camera control".
- When the IP address already in use is entered and the [Set] button is clicked, the respective host information will be overwritten.
- A "Set address" error message is displayed if the IP address of the PC has not been set properly. Check the set IP address of the PC again.

### **[Access level]**

Select the access level of the host from the following.

1. Administrator/ 2. Camera control/ 3. Live only

Refer to "2.7.1 Configure the settings relating to the user authentication [User auth.]" for further information about the access level.

- **Default:** 3. Live only

### **[Host check]**

From the pull-down menu of "Host check", the registered host can be selected and the selected host's IP address can be checked.

The registered IP address will be displayed with the access level.

(Example: 192.168.0.21 [1])

To delete the registered host, click the [Delete] button after selecting the IP address to be deleted.

## **2.7.3 Configure IEEE 802.1X [IEEE 802.1X]**

Click the [IEEE 802.1X] tab on the "User mng." page. (→For menu display and how to operate, refer to "2.2.1 How to display the setup menu", "2.2.2 How to operate the setup menu")

The settings relating to IEEE 802.1X can be configured on this page.

This function can be used when making secure network environments using authentication LAN switches. For further information about authentication LAN switches, consult with your network administrator. Because the

procedure changes according to [EAP method], configure using the following procedure. If “On” is selected for [IEEE 802.1X], start configuring settings with “Off” selected for [IEEE 802.1X].

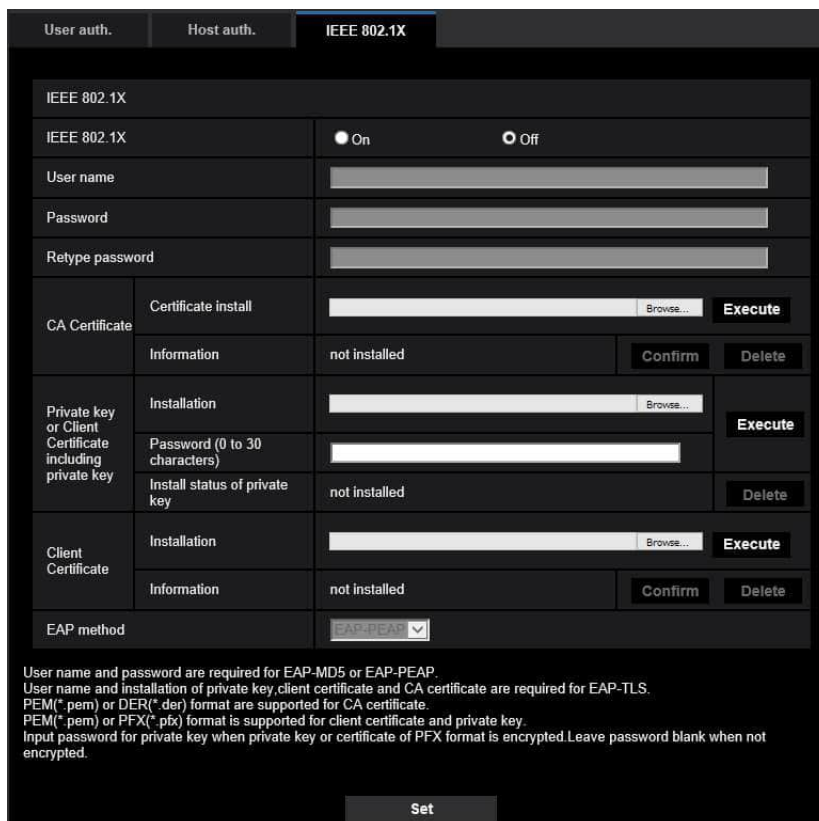

### [IEEE 802.1X]

Select “On” or “Off” to determine whether or not to perform port authentication using IEEE 802.1X.

- **Default:** Off

### [User name]

Enter the user name to access the authentication LAN switch.

- **Available number of characters:** 1 - 32 characters
- **Unavailable characters:** " & ; \

### [Password]

#### [Retype password]

Enter the password to access the authentication LAN switch.

- **Available number of characters:** 4 - 32 characters
- **Unavailable characters:** " &

### [CA Certificate] - [Certificate install]

Install the root CA Certificate. Do not include the intermediate CA Certificate. Installation is possible only when “Off” is selected for “IEEE 802.1X”.

- Specification of CA Certificate

Item	Specifications	Remarks
Data format	Format: PEM or DER	Extension: pem or der

Item	Specifications	Remarks
Max. number of certificates included in the PEM format	1 pc.	—
Max. size of certificate	Approx. 10 kB	—

**[CA Certificate] - [Information]**

**not installed:** indicates that the certificate is not installed.  
**CA certificate host name:** indicates that the certificate is installed.  
**Expired:** indicates that the certificate is expired.  
 The details of CA Certificate can be checked with the [Confirm] button.  
 When the [Delete] button is clicked, the CA certificate will be deleted.

**Note**

- Check that the CA certificate has not expired. If you use a certificate that have expired, you may not be able to connect to authentication LAN switches.

**[Private key or Client Certificate including private key] - [Installation]**

Install the private key or Client Certificate that includes private key.  
 Installation is possible only when “Off” is selected for “IEEE 802.1X”.

■ Specification of private key and Client Certificate including private key

Item	Specifications	Remarks
Data format	Format: PEM or PFX	Extension: pem or pfx
Key size [bit]	1024 /1536 /2048 /3072 /4096	—
Max. number of certificates included in the PEM format	6 pc.	—
Max. size of certificate (including intermediate CA Certificate)	Approx. 10 kB	—

**[Private key or Client Certificate including private key] - [Password]**

Enter the password if the private key is encrypted or the password is set for Client Certificate for the PFX method. Leave password blank when not encrypted.

**Available number of characters:** 0 - 30 characters

**[Private key or Client Certificate including private key] - [Install status of private key]**

**not installed:** Private key is not installed.  
**installed:** Private key is installed.  
 When the [Delete] button is clicked, the private key will be deleted.

**[Client Certificate] - [Installation]**

Install the Client Certificate.  
 If signed by the intermediate CA Certificate, install the Client Certificate including the intermediate CA Certificate.  
 Installation is possible only when “Off” is selected for “IEEE 802.1X”.

■ Specification of Client Certificate

Item	Specifications	Remarks
Data format	Format: PEM	Extension: pem

Item	Specifications	Remarks
Max. number of certificates included in the PEM format	6 pc.	—
Max. size of certificate (including intermediate CA Certificate)	Approx. 10 kB	—

### [Client Certificate] - [Information]

**not installed:** indicates that the certificate is not installed.

**Certificate host name:** indicates that the certificate is installed.

**Expired:** indicates that the certificate is expired.

The details of Client Certificate can be checked with the [Confirm] button.

When the [Delete] button is clicked, the client certificate will be deleted.

#### Note

- Check that the client certificate has not expired. If you use a certificate that has expired, you may not be able to connect to authentication LAN switches.

### [EAP method]

Select the authentication method from EAP-MD5, EAP-PEAP or EAP-TLS.

#### EAP-MD5/EAP-PEAP

1. Select "On" for "IEEE 802.1X".
2. Select "EAP-MD5" or "EAP-PEAP" for "EAP method".
3. Click the [Set] button after entering the user name, the password, and confirming the password.

#### EAP-TLS

1. Click the [Browse] button of "CA Certificate" - "Certificate install". Then, select a CA Certificate and click the [Execute] button. The host name (CommonName) specified when creating certificates will be displayed for "Information".
2. Click the [Browse] button of "Private key or Client Certificate including private key", and select a private key or Client Certificate that includes Private key.
3. Enter the password if the private key is encrypted or the password is set for Client Certificate for the PFX method. Leave password blank when not encrypted.
4. Click the [Execute] button to start installation.  
"installed" will be displayed for "Install status of private key".  
In the case of selecting Client Certificate including the private key, "installed" will be displayed for "Client Certificate" - "Information" as well.
5. When the private key is installed in step 2, select a Client Certificate after clicking the [Browse] button of "Client Certificate", and then click the [Execute] button. The host name (CommonName) specified when creating certificates will be displayed for "Information".
6. Select "On" for "IEEE 802.1X". Then, select "EAP-TLS" for "EAP method".
7. Enter the user name registered to the server in "User name". Then, click the [Set] button.  
If no user name is registered to the server, enter an arbitrary user name.  
"Password" and "Retype password" can be left blank.

#### Note

- To delete each certificate, set [IEEE 802.1X] to "Off".
- Check that the CA certificate and client certificate have not expired. If you use certificates that have expired, you may not be able to use the port notification feature.

### Example of CA Certificate check screen

CA Certificate - Confirm	
Common Name	Microsoft
Country	JP
State	Osaka
Locality	Kyoto
Organization	Microsoft
Organizational Unit	Development

**Close**

### Example of Client Certificate check screen

Client Certificate - Confirm	
Common Name	Microsoft
Country	JP
State	Osaka
Locality	Kyoto
Organization	Microsoft
Organizational Unit	Development

**Close**

### **IMPORTANT**

- After selecting “On” for “IEEE 802.1X”, if access to the camera fails for some reason, connect to a switch or port without authentication. It disables IEEE 802.1X, and enables access to the camera.
- If the Client Certificate includes intermediate CA Certificate, the Client Certificate needs to come first, then the intermediate CA Certificate.
- When a certificate over 10 kbyte is installed, no error will be displayed during installation. However, an error may occur at the time of connection.

---

## 2.8 Configuring the network settings [Network]

The network settings can be configured on the “Network” page.  
The “Network” page has the [Network] tab and the [Advanced] tab.

### 2.8.1 Configure the network settings [Network]

Click the [Network] tab on the “Network” page. (→For menu display and how to operate, refer to “2.2.1 How to display the setup menu”, “2.2.2 How to operate the setup menu”)

The following information is required to configure the network settings. Contact the network administrator or your Internet service provider.

- IP address
- Subnet mask
- Default gateway (when using the gateway server/router)
- HTTP port
- Primary DNS address, Secondary DNS address (when using DNS)



## IPv4 network

### [Network Settings]

Select the method of how to configure the IP address from the following.

- **Static:** The IP address is configured by entering manually on "IP address(IPv4)".
- **DHCP:** The IP address is configured using the DHCP function. When failed to acquire an IP address from the DHCP server, 192.168.0.10 will be set to the IP address. After that, when successfully acquired an IP address from the DHCP server, the address will be changed to the acquired IP address.
- **Auto(AutoIP):** The IP address is configured using the DHCP function. When the DHCP server is not found, the IP address is automatically configured.
- **Auto(Advanced):** Using the DHCP function, network address information is referred to, and an unused IP address is configured to the camera as a static IP address. The configured IP address is automatically determined within the subnet mask range by the camera. When the DHCP server is not found, the IP address is set to 192.168.0.10.

- **Default:** DHCP

#### **Note**

- When “Auto(AutoIP)” is selected and the IP address cannot be obtained from the DHCP server, an IP address not used in the same network will be searched within 169.254.1.0 - 169.254.254.255.

#### **[IP address(IPv4)]**

When not using the DHCP function, enter the IP address of the camera. Do not enter an IP address already in use (for the PCs and the other network cameras).

- **Default:** 192.168.0.10

#### **Note**

- Multiple IP addresses are unavailable even when using the DHCP function. Refer to the network administrator for further information about the settings of the DHCP server.

#### **[Subnet mask]**

When not using the DHCP function, enter the subnet mask of the camera.

- **Default:** 255.255.255.0

#### **[Default gateway]**

When not using the DHCP function, enter the default gateway of the camera.

- **Default:** 192.168.0.1

#### **Note**

- Multiple IP addresses for the default gateway are unavailable even when using the DHCP function. Refer to the network administrator for further information about the settings of the DHCP server.

#### **[DNS]**

Determine how to set the address of the DNS server by selecting “Auto” (obtain the address automatically) or “Manual” (enter the address of the DNS server). When “Manual” is selected, it is necessary to configure the settings for the DNS.

When using the DHCP function, it is possible to obtain the DNS address automatically by selecting “Auto”. Refer to the network administrator for further information about the settings.

- **Default:** Auto

#### **[Primary server address], [Secondary server address]**

When “Manual” is selected for “DNS”, enter the IP address of the DNS server. Refer to the network administrator about the IP address of the DNS server.

## **IPv6 network**

#### **[Manual]**

Select “On” or “Off” to determine whether or not to manually configure the IP address for IPv6 network (IPv6 address).

- **On:** Enter an IPv6 address manually.
- **Off:** Manual entry of an IPv6 address will become unavailable.
- **Default:** Off

#### **[IP address(IPv6)]**

When “On” is selected for “Manual”, manual entry of the IPv6 address is required. Do not enter an address already in use.

### Note

- When connecting to the manually configured IPv6 address beyond the router, use an IPv6 compatible router and turn on the automatic IPv6 address assignment function. In this case, it is necessary to configure IPv6 address including prefix information provided from the IPv6 compatible router. Refer to the manuals provided with the router for further information.

### [Default gateway]

When “On” is selected for “Manual” of IPv6 network, enter the default gateway of IPv6 network of the camera.

- **Default:** None (blank)

### [DHCPv6]

Select “On” or “Off” to determine whether or not to use the IPv6 DHCP function.

Configure the DHCP server not to assign the same IP addresses used for the other network cameras and PCs whose IP address is unique. Refer to the network administrator for further information about the settings of the server.

- **Default:** Off

### [Primary DNS server address], [Secondary DNS server address]

Enter the IPv6 address of the DNS server. Refer to the network administrator about the IPv6 address of the DNS server.

## Common

### [HTTP port]

Assign the port numbers independently.

- **Available port number:** 1 - 65535
- **Default:** 80

The following port numbers are unavailable since they are already in use.

20, 21, 23, 25, 42, 53, 67, 68, 69, 110, 123, 161, 162, 443, 554, 995, 10669, 10670, 59000 - 61000

### [Line speed]

Select the line speed for data transmission from the following. It is recommended to use with the default “Auto”.

- **Auto:** Line speed will be applied automatically.
- **100M-Full:** 100 Mbps full-duplex
- **100M-Half:** 100 Mbps half-duplex
- **10M-Full:** 10 Mbps full-duplex
- **10M-Half:** 10 Mbps half-duplex
- **Default:** Auto

### [Max RTP packet size]

Select “Unlimited(1500byte)” or “Limited(1280byte)” to determine whether or not to restrict the RTP packet size when viewing images from the camera using the RTP protocol. It is recommended to use with the default “Unlimited(1500byte)”.

When the RTP packet size is restricted in the network line in use, select “Limited(1280byte)”. Refer to the network administrator for further information about the maximum packet size in the network line.

- **Default:** Unlimited(1500byte)

### [HTTP max segment size(MSS)]

Select “Unlimited(1460byte)”, “Limited(1280byte)”, or “Limited(1024byte)” to determine whether or not to restrict the maximum segment size (MSS) when viewing images from the camera using the HTTP protocol. We recommended that you use this feature with the default setting.

When the MSS is restricted in the network line in use, select "Limited(1024byte)" or "Limited(1280byte)". Refer to the network administrator for further information about the MSS in the network line.

- **Default:** Unlimited(1460byte)

### **[Bandwidth control(bit rate)]**

Select the total bit rate for data transmission from the following.

Unlimited/ 64kbps/ 128kbps/ 256kbps/ 384kbps/ 512kbps/ 768kbps/ 1024kbps/ 2048kbps/ 4096kbps/ 6144kbps/ 8192kbps/ 10240kbps/ 15360kbps/ 20480kbps/ 25600kbps

- **Default:** 25600kbps

### **Note**

- When "Bandwidth control(bit rate)" is set low, taking a picture using the snap shot button may not function depending on the usage environment. In this case, select "JPEG" on the "Live" page and take a picture with the snap shot button using the lowest possible image capture size.

### **[Easy IP Setup accommodate period]**

Select "20min" or "Unlimited" to determine how long the network setting operation using the "IP Setting Software" can be allowed.

- **20min:** The network setting operation using the "IP Setting Software" are allowed for 20 minutes since the camera starts up.
- **Unlimited:** The network setting operation using the "IP Setting Software" are allowed without time limitation.
- **Default:** 20min

### **Note**

- The camera information display using the "IP Setting Software" is allowed without time limitation, and camera images can be opened.
- Refer to the network administrator for the addresses of each server.
- The port forwarding function changes a global IP address to a private IP address, and "Static IP masquerade" and "Network Address Translation (NAT)" have this function. This function is to be set in a router.

## 2 Settings

- To access the camera via the Internet by connecting the camera to a router, it is necessary to assign a respective HTTP port number for each camera and address translation by using the port forwarding function of the router. For further information, refer to the operating instructions of the router in use.

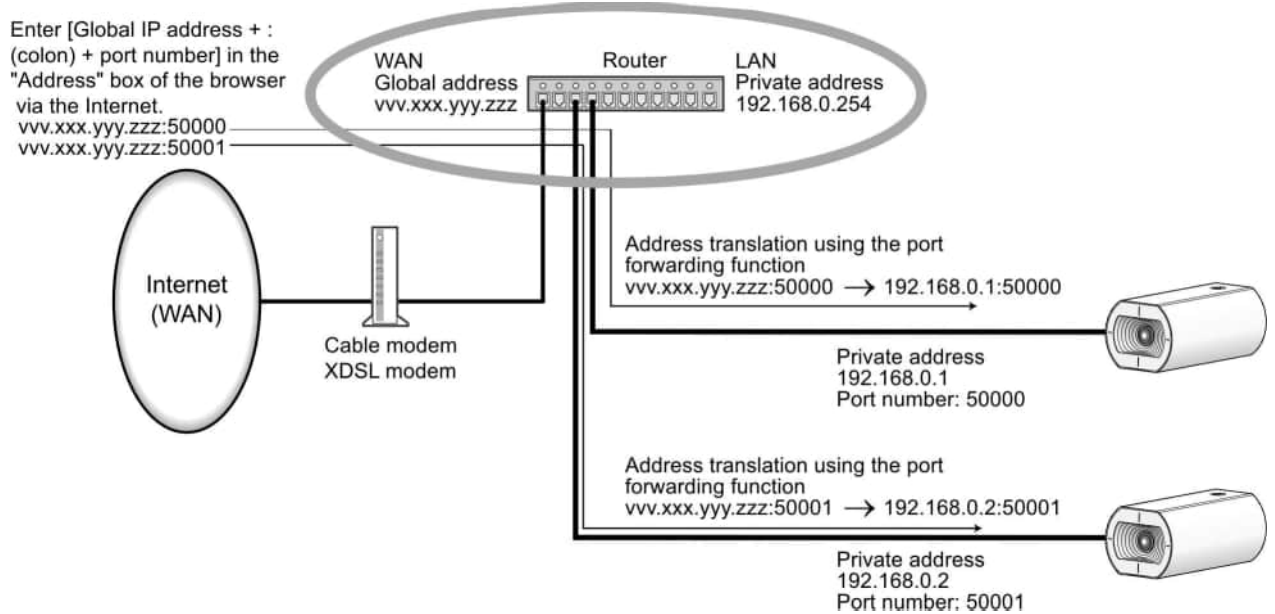

### [ONVIF®]

Select "On" or "Off" to determine whether to enable the ONVIF function.

On: Access from an ONVIF device is enabled.

Off: Access from an ONVIF device is disabled.

- Default:** On

\* ONVIF is the trademark of ONVIF, Inc.

## 2.8.2 Configure advanced network settings [Advanced]

Click the [Advanced] tab on the "Network" page. (→For menu display and how to operate, refer to "2.2.1 How to display the setup menu", "2.2.2 How to operate the setup menu")

The settings related to SMTP (E-mail), NTP, UPnP, HTTPS, DDNS, SNMP, QoS can be configured in this section.

You can move to the setting page of a setting item by clicking the corresponding link for that setting item.

## 2.8.2.1 Configure the settings related to sending E-mails

The screenshot shows the 'Advanced' settings for SMTP(E-mail). At the top, there are navigation links: SMTP(E-mail) | NTP | UPnP | HTTPS | DDNS | SNMP | QoS. The main configuration area includes:

- SMTP(E-mail)** section:
  - E-mail notification:  On  Off
  - SMTP server address: [Text field] Example of entry: 192.168.0.10
  - SMTP port: [Text field] (1-65535)
  - POP server address: [Text field] Example of entry: 192.168.0.10
  - Authentication:
    - Type:  None  POP before SMTP  SMTP
    - User name: [Text field]
    - Password: [Text field]
  - Sender's E-mail address: [Text field]
  - SSL:  On  Off
- Destination of notification** section:
  - Destination E-mail address: [Text field] Delete
  - Address 1: [Text field] Delete
    - VMD  SCD  Command alarm
    - Diag.
  - Address 2: [Text field] Delete
    - VMD  SCD  Command alarm
    - Diag.
  - Address 3: [Text field] Delete
    - VMD  SCD  Command alarm
    - Diag.
  - Address 4: [Text field] Delete
    - VMD  SCD  Command alarm
    - Diag.
- E-mail subject(Alarm)**:  Use the camera title  Cause of alarm
- E-mail subject(Diag.)**:  Use the camera title
- E-mail body(Alarm)**:
  - Cause of alarm  Occurrence time
  - Preview: The %p% alarm was occurred at %t%.

A 'Set' button is located at the bottom of the configuration area.

### [E-mail notification]

Select “On” or “Off” to determine whether or not to provide notification by E-mail according to the settings for the “Alarm” and “Diag.” checkboxes of “Destination of notification” below.

- When an alarm is detected (“Alarm”)
- When a notification of the remaining capacity of the SD memory card has been provided (“Diag.”)
- When the SD memory card has become full (“Diag.”)
- When the SD memory card cannot be recognized (“Diag.”)
- **Default:** Off

### [SMTP server address]

Enter the IP address or the host name of the SMTP server used to send E-mails.

- **Available number of characters:** 1 - 128 characters
- **Available characters:** Alphanumeric characters, the colon (:), the period (.), the underscore (\_), and the hyphen (-).

### [SMTP port]

Enter the port number to which E-mails are sent.

- **Available port number:** 1-65535
- **Default:** 25

The following port numbers are unavailable since they are already in use.

20, 21, 23, 42, 53, 67, 68, 69, 80, 110, 123, 161, 162, 443, 995, 10669, 10670

### [POP server address]

When "POP before SMTP" is selected for "Type", enter the IP address or the host name of the POP server.

- **Available number of characters:** 1 - 128 characters
- **Available characters:** Alphanumeric characters, the colon (:), the period (.), the underscore (\_), and the hyphen (-).

### **IMPORTANT**

- When entering the host name for "SMTP server address" or "POP server address", it is necessary to configure the DNS settings on the [Network] tab of the "Network" page. (→"2.8.1 Configure the network settings [Network]")

### [Authentication]

- **Type**  
Select the authentication method to send E-mails from the following.
  - **None:** It is not necessary to clear any authentication to send E-mails.
  - **POP before SMTP:** It is necessary to first clear the POP server authentication to use the SMTP server to send E-mails.
  - **SMTP:** It is necessary to clear the SMTP server authentication to send E-mails.
  - **Default:** None

#### **Note**

- When you don't know the authentication method to send E-mails, refer to the network administrator.
- **User name**  
Enter the user name to access the server.
  - **Available number of characters:** 0 - 32 characters
  - **Unavailable characters:** " & ; \
- **Password**  
Enter the password to access the server.
  - **Available number of characters:** 0 - 32 characters
  - **Unavailable characters:** " &

### [Sender's E-mail address]

Enter the E-mail address of a sender.

The entered E-mail address will be displayed in the "From" (sender) line of the sent E-mails.

- **Available number of characters:** 3 - 128 characters
- **Available characters:** Alphanumeric characters, the at sign (@), the period (.), the underscore (\_), and the hyphen (-).

**[SSL]**

Select "On" if you want to use SSL encryption when sending E-mail notifications for alarm occurrences or the "Diag." function. When you select "On", the authentication method will be set to "SMTP". Set the user name and the password used for authentication.

- **Default:** Off

**Note**

- Some SMTP servers may not support SSL.
- SSL supports SMTP over SSL, but STARTTLS is not supported.
- When "On" is selected, the SMTP port number may need to be set to 465. Ask your Internet service provider for the appropriate settings.

**[Address 1] - [Address 4]**

Enter the destination E-mail address. Up to 4 destination E-mail addresses can be registered.

- **Available number of characters:** 3 - 128 characters
- **Available characters:** Alphanumeric characters, the at sign (@), the period (.), the underscore (\_), and the hyphen (-).  
To delete the registered address, click the [Delete] button respective to the desired address.
- **VMD:** Notify by e-mail when motion is detected.
- **SCD:** Notify by e-mail when scene change is detected.
- **Command alarm:** Notify by e-mail when a command alarm is entered.
- **Diag.:**
  - When a notification of the remaining capacity of SD memory card has been provided
  - When the SD memory card has become full
  - When the SD memory card cannot be recognized

**Note**

- In the diagnostic e-mail notification sent when you have checked the destination of notification [Diag.] field, the contents of the [E-mail subject(Alarm)] and [E-mail body(Alarm)] which are set later are not changed.

**[E-mail subject(Alarm)]**

Enter the E-mail subject.

- **Available number of characters:** 0 - 50 characters
- **Use the camera title:** The camera title will be displayed in the e-mail subject.
- **Cause of alarm:** Adds the cause of alarm to the E-mail subject.

**[E-mail subject(Diag.)]**

Enter the E-mail subject.

- **Available number of characters:** 0 - 50 characters
- **Use the camera title:** The camera title will be displayed in the e-mail subject.

**[E-mail body(Alarm)]**

Enter the E-mail body.

- **Available number of characters:** 0 - 200 characters
- **Cause of alarm:** The cause of alarm %p% is added in the e-mail body. %p% is replaced by the cause of alarm and sent.
  - For VMD alarm: "VMD"
  - For SCD alarm: "SCD"
  - For command alarm: "CMD"
- **Occurrence time:** The time of occurrence %t% will be added to the e-mail body. %t% will be replaced by the time of occurrence of the alarm (HH:MM:SS) and sent.

- **Default:**
  - Cause of alarm: Checked
  - Occurrence time: Checked
  - E-mail body: The %p% alarm was occurred at %t%.

### Note

- Notification E-mail will be sent with the message “The capacity of the SD memory card is full.” when the SD memory card has become full, or “The SD memory card cannot be detected.” when mounting of the SD memory card failed.
- Entering alternative text into the E-mail body automatically adds the event or time when an alarm occurs.  
Alternative text cause of alarm: %p%, occurrence time: %t%  
(Examples of use)  
After setting the following characters in the E-mail body, there is a VMD alarm occurrence at the time 19:13:24.  
E-mail body settings: %p% alarm occurred at %t%.  
Sent E-mail body: “A “VMD” alarm occurred at 19:13:24.”  
When the body of the email is empty, the language that the email is sent in is determined by “Menu language” of “Basic”. If “Japanese” is specified, email is sent in Japanese. If another language is specified, email is sent in English.

### Example of e-mail notification

An e-mail format in which the camera title check box is specified in the e-mail subject and the cause of alarm/occurrence time are specified in the e-mail body

Example e-mail:

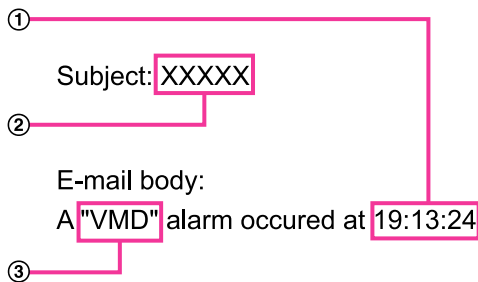

- ① The alarm occurrence time is assigned.
- ② The camera title is used as the e-mail subject.
- ③ The alarm cause is assigned.

## 2.8.2.2 Configure the settings relating to the NTP server

The settings relating to the NTP server such as the NTP server address, port number, etc. can be configured on this page.

**IMPORTANT**

- Use an NTP server when the more accurate time & date setting is required for the system operation.

The screenshot shows a configuration page for NTP. At the top, there are tabs for 'Network' and 'Advanced', with 'Advanced' selected. Below the tabs are links for 'SMTP(E-mail)', 'NTP', 'UPnP', 'HTTPS', 'DDNS', 'SNMP', and 'QoS'. The main section is titled 'NTP' and contains several settings:

- Time adjustment:** Two radio buttons are present. 'Manual' is selected, and 'Synchronization with NTP server' is unselected.
- NTP server address setting:** A dropdown menu is set to 'Manual'.
- NTP server address:** A text input field with the example entry '192.168.0.10'.
- NTP port:** A text input field with the value '123' and a note '(1-65535)'.
- Time adjustment interval:** A dropdown menu set to '10'.

A 'Set' button is located at the bottom of the form.

**[Time adjustment]**

Select the time adjustment method from the following. Time adjusted by the selected method will be used as the standard time of the camera.

- **Manual:** Time set on the [Basic] tab on the “Basic” page will be used as the standard time of the camera.
- **Synchronization with NTP server:** Time automatically adjusted by synchronizing with the NTP server will be used as the standard time of the camera.
- **Default:** Manual

**[NTP server address setting]**

When “Synchronization with NTP server” is selected for “Time adjustment”, select the method of how to obtain the NTP server address from the following.

- **Auto:** Obtains the NTP server address from the DHCP server.
- **Manual:** The NTP server address will be entered manually on “NTP server address”.
- **Default:** Manual

**IMPORTANT**

- When obtaining the NTP server address from the DHCP server, it is necessary to select “DHCP”, “Auto(AutoIP)”, or “Auto(Advanced)” for “Network Settings” on the [Network] tab of the “Network” page. (→“2.8.1 Configure the network settings [Network]”)

**[NTP server address]**

When “Manual” is selected for “NTP server address setting”, enter the IP address or the host name of the NTP server.

- **Available number of characters:** 1 - 128 characters
- **Available characters:** Alphanumeric characters, the colon (:), the period (.), the underscore (\_), and the hyphen (-).
- **Default:** None (blank)

**IMPORTANT**

- When entering the host name for “NTP server address”, it is necessary to configure the DNS settings on the [Network] tab of the “Network” page. (→“2.8.1 Configure the network settings [Network]”)

**[NTP port]**

Enter a port number of the NTP server.

- **Available port number:** 1 - 65535

## 2 Settings

---

- **Default:** 123

The following port numbers are unavailable since they are already in use.

20, 21, 23, 25, 42, 53, 67, 68, 69, 80, 110, 161, 162, 443, 995, 10669, 10670

### [Time adjustment interval]

Select an interval (1 - 24 hours: in 1 hour intervals) of synchronization with the NTP server.

- **Default:** 1h

### 2.8.2.3 Configure the UPnP settings

This camera support UPnP (Universal Plug and Play). By using the UPnP function, it becomes possible to configure the following automatically.

- Configuration of the port forwarding function of the router (However, a router supporting UPnP is required.) This configuration is useful when accessing the camera via the Internet, or from a mobile terminal/tablet device.
- Automatic refreshment of the shortcut to the camera that is created on the [Network] folder of the PC even when the IP address of the camera changes.



### [Auto port forwarding]

Select "On" or "Off" to determine whether or not to use the port forwarding function of the router.

To use the port forwarding function, the router in use must support UPnP and the UPnP must be enabled.

- **Default:** Off

### Note

- Due to port forwarding, the port number may sometimes be changed. When the number is changed, it is necessary to change the port numbers registered in the PC and recorders, etc.
- The UPnP function is available when the camera is connected to the IPv4 network. IPv6 is not supported.
- To check if auto port forwarding is properly configured, click the [Status] tab on the "Maintenance" page, and check that the "Enable" is displayed for "Status" of "UPnP". (→"2.10.3 Check the status [Status]")  
When "Enable" is not displayed, refer to "Cannot access the camera via the Internet." in the "3.2 Troubleshooting" section. (→"3.2 Troubleshooting")

### [Camera short cut]

Select whether or not to create the shortcut to the camera on the [Network] folder of the PC. When creating the shortcut, select "On".

To use the shortcut function to the camera, enable the UPnP function on the PC in advance.

- **Default:** Off

**Note**

- To display the shortcut to the camera on the [Network] folder of the PC, it is necessary to add the Windows component. Refer to the following to enable the UPnP function.

**For Windows 8.1**

Right-click [Start] → select [Control Panel] → [Network and Internet] → [Network and Sharing Center] → select [Turn on network discovery] of [Network discovery] of [Change advanced sharing settings] → click [Save changes] → Complete

**For Windows 10**

[Start] → [Settings] → [NETWORK & INTERNET] → [Ethernet] → [Network and Sharing Center] → select [Turn on network discovery] of [Network discovery] of [Change advanced sharing settings] → click [Save changes] → Complete

## 2.8.2.4 Configure the HTTPS settings

It is possible to enhance the network security by encrypting the access to cameras using the HTTPS function. Refer to “2.8.3 How to configure HTTPS settings” for how to configure the HTTPS settings.

The screenshot shows the 'Advanced' tab of the Network settings interface. At the top, there are navigation links: SMTP(E-mail), FTP, NTP, UPnP, HTTPS, DDNS, SNMP, and QoS. The 'HTTPS' section is expanded, showing the following settings:

- Connection:** A dropdown menu set to 'HTTP'. A tooltip indicates: "When 'HTTPS' is selected for 'Connection', the maximum bandwidth(bit rate) is limited to 32Mbps."
- Select certificate:** A dropdown menu set to 'Pre-installed'.
- HTTPS port:** A text input field containing '443' with a range '(1-65535)' to its right.
- Pre-installed certificate:** A section with a 'Download root certificate' button labeled 'Execute'.
- CA Certificate:** A section with three buttons: 'CRT key generate' (Execute), 'Generate Certificate Signing Request' (Execute), and 'CA Certificate install' (Browse... Execute).
- Information:** A section showing 'Invalid' with 'Confirm' and 'Delete' buttons.

A 'Set' button is located at the bottom of the form.

**[HTTPS - Connection]**

Select the protocol used to connect the camera.

- HTTP:** HTTP and HTTPS connections are available.
- HTTPS:** Only the HTTPS connection is available.
- Default:** HTTP

**Note**

- To change to an HTTPS connection when HTTP is selected, perform HTTPS connection settings first. The HTTPS connection will be available even if the setting is changed to HTTP afterwards.

**[HTTPS - Select certificate]**

Select the certificate to be used with HTTPS.

- Pre-installed:** Select a pre-installed certificate.
- CA:** Select a CA certificate. Only displayed when the CA Certificate is installed.

- **Default:** Pre-installed

### [HTTPS - HTTPS port]

Designate the HTTPS port number to be used.

- **Available port number:** 1 - 65535
- **Default:** 443

The following port numbers are unavailable since they are already in use.

20, 21, 23, 25, 42, 53, 67, 68, 69, 80, 110, 123, 161, 162, 554, 995, 10669, 10670, 59000-61000

### [Pre-installed certificate - Download root certificate]

Click the [Execute] button to download the root certificate for the pre-installed certificate. By installing the root certificate to your PC, you can get signature verification for the pre-installed certificate.

### [CA Certificate - CRT key generate]

CRT key (SSL encryption key) used for the HTTPS protocol is generated. To generate the CRT key, click the [Execute] button to display "CRT key generate" dialog box.

### [CA Certificate - Generate Certificate Signing Request]

When using the security certificate issued by CA (Certificate Authority) as the security certificate used for the HTTPS protocol, the CSR (Certificate Signing Request) will be generated.

To generate the CSR, click the [Execute] button to display the "CA Certificate - Generate Certificate Signing Request" dialog window.

### [CA Certificate - CA Certificate install]

Installs the CA certificate (security certificate) issued by CA (Certificate Authority) and displays the information of the installed CA certificate (security certificate).

To install the CA certificate (security certificate), click the [Browse...] button to display the [Open] dialog box, and select the file of the CA certificate (security certificate) issued by CA, and click the [Execute] button.

If the CA certificate (security certificate) is already installed, the file name of the installed CA certificate (security certificate) will be displayed.

### [CA Certificate - Information]

Displays the information of the CA certificate (security certificate).

When the [Confirm] button is clicked, the registered information of the installed CA certificate (security certificate) will be displayed in the "CA Certificate - Confirm" dialog box. If the CA certificate (security certificate) is not installed, the content of the generated CSR file will be displayed.

When the [Delete] button is clicked, the installed CA certificate (security certificate) will be deleted.

## **IMPORTANT**

- Before deleting the valid CA certificate (security certificate), confirm that there is a backup file of the CA certificate (security certificate) on the PC or another media. The backup file of the CA certificate (security certificate) will be required when installing the CA certificate (security certificate) again.

## **Note**

- After changing the connection setting, access the camera again by after waiting a while according to the changed setting ("http://IP address of the camera" or "https://IP address of the camera").
- When the camera is accessed using the HTTPS protocol, the refresh interval and frame rate of images may be lower.
- When the camera is accessed using the HTTPS protocol, it may take time to display images.
- When the camera is accessed using the HTTPS protocol, the images may be distorted or audio may be interrupted.
- The maximum number of concurrent access user varies depending on the maximum image size and transmission format.

## 2.8.2.5 Configure the settings relating to DDNS

To access this camera via the Internet, it is necessary to configure the settings for the DDNS function. Refer to “2.8.6 How to configure the settings relating to DDNS” for how to configure the settings relating to DDNS.

DDNS	
Area	Global
Service	Viewnetcam.com
Personal(Camera) URL	
Your Account Link	
Access interval	1h
Global IP Address Notification Method	<input checked="" type="radio"/> Normal <input type="radio"/> Advanced

**Set**

### [Area]

Select the region where the camera is installed.  
Japan/Global

### Note

- If the camera is used in Japan, select “Japan”. If the camera is used outside of Japan, select “Global”. The “Viewnetcam.com” service that is displayed when “Global” is selected cannot be used in Japan.

### [Service]

Select the DDNS service to determine whether or not to use DDNS.

- **Off:** Does not use the DDNS function.
- **Viewnetcam.com:** Uses the “Viewnetcam.com” service.
- **Dynamic DNS Update:** Uses Dynamic DNS Update (RFC2136 compliant) without the DHCP cooperation.
- **Dynamic DNS Update(DHCP):** Uses Dynamic DNS Update (RFC2136 compliant) with the DHCP cooperation.
- **Default:** Off

### Note

- When using Dynamic DNS Update (RFC2136 compliant), refer to the network administrator for whether or not to cooperate with the DHCP.

## 2.8.2.6 Configure the settings relating to SNMP

The settings relating to SNMP can be configured on this page. It is possible to check the status of the camera by connecting to the SNMP manager. When using the SNMP function, contact the network administrator.

The screenshot shows a web interface for configuring SNMP settings. At the top, there are tabs for 'Network' and 'Advanced', with 'Advanced' selected. Below the tabs are navigation links: SMTP(E-mail), FTP, NTP, UPnP, HTTPS, DDNS, SNMP, and QoS. The main content area is divided into several sections:

- SNMP agent setting:**
  - SNMP version: A dropdown menu set to 'SNMPv1/v2'.
  - SNMPv1/v2: Fields for 'Community' and 'Manager address'.
  - SNMPv3: Fields for 'User name (1 to 32 characters)', 'Authentication' (radio buttons for MD5 and SHA1), 'Encryption method' (radio buttons for DES and AES), and 'Password (8 to 16 characters)'.
- SNMPv2-MIB system setting:**
  - System name, Location, and Contact: Text input fields.
- SNMP trap setting:**
  - SNMP trap setting: Radio buttons for 'On' and 'Off'.
  - Destination of Trap: Fields for 'Address' and 'Port number' (with a hint '(1-65535)').
  - SNMPv2c: Field for 'Community'.
- Trap setting:** A table with columns 'Enable/Disable' and 'Trap string'.
 

Trap setting	Enable/Disable	Trap string
SNMP Generic trap	<input type="checkbox"/> coldStart	cold start
	<input type="checkbox"/> linkUp	linkup
	<input type="checkbox"/> authenticationFailure	auth error
Alarm	<input type="checkbox"/> VMD	VMD alarm
	<input type="checkbox"/> Command alarm	cmd
SD memory card	<input type="checkbox"/> Diag.	sd alarm

At the bottom of the page, there is a 'Set' button.

### SNMP agent setting

#### [SNMP version]

Select the SNMP version to be used.

- **SNMPv1/v2:** SNMPv1/v2 is activated.
- **SNMPv3:** SNMPv3 is activated.
- **SNMPv1/v2/v3:** SNMPv1/v2/v3 is activated.
- **Default:** SNMPv1/v2

**[SNMPv1/v2] - [Community]**

Enter the community name to be monitored.

- **Available number of characters:** 0 - 32 characters
- **Default:** None (blank)

**IMPORTANT**

- When using the SNMP function with SNMPv1/v2, it is necessary to enter a community name. When no community name is entered, the SNMP function will not work. Do not set a community name that can easily be guessed. (Example: public)

**[SNMPv1/v2] - [Manager address]**

Enter the IP address of the SNMP manager from which requests are to be permitted when the SNMP version is v1 or v2. When left blank, requests from all IP addresses will be permitted.

- **Available number of characters:** 1 - 128 characters
- **Available characters:** Alphanumeric characters, the colon (:), the period (.), the underscore (\_), the hyphen (-) and the slash (/).
- **Default:** None (blank)

**Note**

- When "IP address/subnet mask" is entered, it is possible to restrict IP address of SNMP manager from which request is permitted by subnet. For example, when "192.168.0.1/24" is entered, all requests from the SMNP managers in the range from "192.168.0.1" to "192.168.0.254" will be permitted.

**[SNMPv3] - [User name]**

Set the SNMPv3 user name.

- **Available number of characters:** Empty field or 1 - 32 characters
- **Unavailable characters:** " & ; \

**[SNMPv3] - [Authentication]**

Select the SNMPv3 authentication method from MD5 or SHA1.

- **Default:** MD5

**[SNMPv3] - [Encryption method]**

Select the SNMPv3 encryption method from DES or AES.

- **Default:** DES

**[SNMPv3] - [Password]**

Set the SNMPv3 password.

- **Available number of characters:**
  - If the authentication method is MD5: Empty field or 8-16 characters
  - If the authentication method is SHA1: Empty field or 8-20 characters
- **Unavailable characters:** " &

**SNMPv2-MIB system setting****[System name]**

Enter a system name to be used to manage the camera with the SNMP function.

- **Available number of characters:** 0 - 32 characters
- **Default:** None (blank)

**[Location]**

Enter the name of the location where the camera is installed.

- **Available number of characters:** 0 - 32 characters

- **Default:** None (blank)

### [Contact]

Enter the E-mail address or the phone number of the SNMP manager.

- **Available number of characters:** 0 - 255 characters
- **Default:** None (blank)

### [SNMP trap setting]

Set On/Off of the SNMP trap.

- **Default:** Off

### [Destination of Trap] - [Address]

Enter the destination address of the SNMP trap.

- **Available number of characters:** 1 - 128 characters
- **Available characters:** Alphanumeric characters, the colon (:), the period (.), the underscore (\_), and the hyphen (-).
- **Default:** None (blank)

### [Destination of Trap] - [Port number]

Enter the port number of the destination address of the SNMP trap.

- **Available port number:** 1 - 65535
  - **Default:** 162
- The following port numbers are unavailable since they are already in use.  
20, 21, 23, 25, 42, 53, 67, 68, 69, 80, 110, 123, 161, 443, 554, 995, 10669, 10670, 59000 - 61000

### [SNMPv2c] - [Community]

Enter the community name of the destination address of the SNMP trap.

- **Available number of characters:** 0 - 32 characters
- **Unavailable characters:** 2-byte characters
- **Default:** None (blank)

## **IMPORTANT**

- When using the SNMP trap function, it is necessary to enter the community name. When no community name is entered, the SNMP trap function will not work.

### Trap setting

#### [SNMP Generic trap] - [coldStart] - [On/Off]

When the check box is checked, a trap (SNMPv2-MIB::coldStart) will be sent.

- **Default:** Not checked (Off)

#### [SNMP Generic trap] - [coldStart] - [Trap string]

When a camera startup trap is to be extended and sent, set the string of characters of the extended trap.

- **Available number of characters:** 0 - 20 characters
- **Available characters:** 0-9, A-Z, a-z and the following marks.  
! " # \$ % & ' ( ) \* + , - . / : ; = ?
- **Default:** cold start

#### [SNMP Generic trap] - [linkUP] - [On/Off]

When the check box is checked, a trap (SNMPv2-MIB::linkup) will be sent at the time when the camera is linked up.

- **Default:** Not checked (Off)

**[SNMP Generic trap] - [linkUP] - [Trap string]**

When a camera linkup trap is to be extended and sent, set the string of characters of the extended trap.

- **Available number of characters:** 0 - 20 characters
- **Available characters:** 0-9, A-Z, a-z and the following marks.  
!"#\$%&'()\*+,-./:;=?
- **Default:** linkup

**[SNMP Generic trap] - [authenticationFailure] - [On/Off]**

When the check box is checked, a trap (SNMPv2-MIB::coldStart) will be sent at the time when an SNMP authentication error occurs.

- **Default:** Not checked (Off)

**[SNMP Generic trap] - [authenticationFailure] - [Trap string]**

When a SNMP authentication error occurrence trap is to be extended and sent, set the string of characters.

- **Available number of characters:** 0 - 20 characters
- **Available characters:** 0-9, A-Z, a-z and the following marks.  
!"#\$%&'()\*+,-./:;=?
- **Default:** auth error

**[Alarm] - [VMD] - [On/Off]**

When the check box is checked, a trap will be sent at the time when a video motion detection is activated.

- **Default:** Not checked (Off)

**[Alarm] - [VMD] - [Trap string]**

Set the string of characters to be used for the trap of [VMD].

- **Available number of characters:** 0 - 20 characters
- **Available characters:** 0-9, A-Z, a-z and the following marks.  
!"#\$%&'()\*+,-./:;=?
- **Default:** VMD alarm

**[Alarm] - [Command alarm] - [On/Off]**

When the check box is checked, a trap will be sent at the time when a command alarm occurs.

- **Default:** Not checked (Off)

**[Alarm] - [Command alarm] - [Trap string]**

Set the string of characters to be used for the trap of [Command alarm].

- **Available number of characters:** 0 - 20 characters
- **Available characters:** 0-9, A-Z, a-z and the following marks.  
!"#\$%&'()\*+,-./:;=?
- **Default:** cmd

**[SD memory card] - [Diag.] - [On/Off]**

When the check box is checked, a trap will be sent in the following cases.

- When a notification of the remaining capacity of SD memory card has been provided
- When the SD memory card has become full
- When the SD memory card cannot be recognized
- **Default:** Not checked (Off)

**[SD memory card] - [Diag.] - [Trap string]**

Set the string of characters to be used for the trap of [Diag.].

- **Available number of characters:** 0 - 20 characters
- **Available characters:** 0-9, A-Z, a-z and the following marks.

! " # \$ % & ' ( ) \* + , - . / : ; = ?

- **Default:** sd alarm

### 2.8.2.7 Configure the QoS settings

The settings relating to the Diffserv function and shaping of stream are configured in this section.

#### Diffserv

The Diffserv function can be used to set the priority of image data sent from routers. The priority set to this function must match the DSCP value configured to the router. When using the Diffserv function, contact the network administrator.

Diffserv	
Image DSCP(0-63)	0
TCP alarm notification DSCP(0-63)	0
Shaping of stream	<input checked="" type="radio"/> On <input type="radio"/> Off

Set

#### [Image DSCP(0-63)]

Enter the packet priority for video data.

- **Available values:** 0 - 63
- **Default:** 0

#### [TCP alarm notification DSCP(0-63)]

Enter the packet priority for TCP alarm notification.

- **Available values:** 0 - 63
- **Default:** 0

#### Shaping of stream

##### [Shaping of stream]

Select On/Off to determine whether or not to control the H.265 image data so that it does not burst. It is effective in situations such as when a network device loses video data from the camera, but the video display may be delayed.

- **Off:** Disables the shaping of stream function.
- **On:** Enables the shaping of stream function.
- **Default:** Off

##### Note

- If you are concerned about delays of the video display, select Off.

### 2.8.3 How to configure HTTPS settings

The settings relating to the HTTPS protocol that can enhance the network security by encrypting the access to cameras on this page.

HTTPS settings can be configured by either using the certificate pre-installed to the camera, or using a CA certificate that you obtained by yourself from the CA (CA: Certification Authority). The settings will be configured in the following procedure.

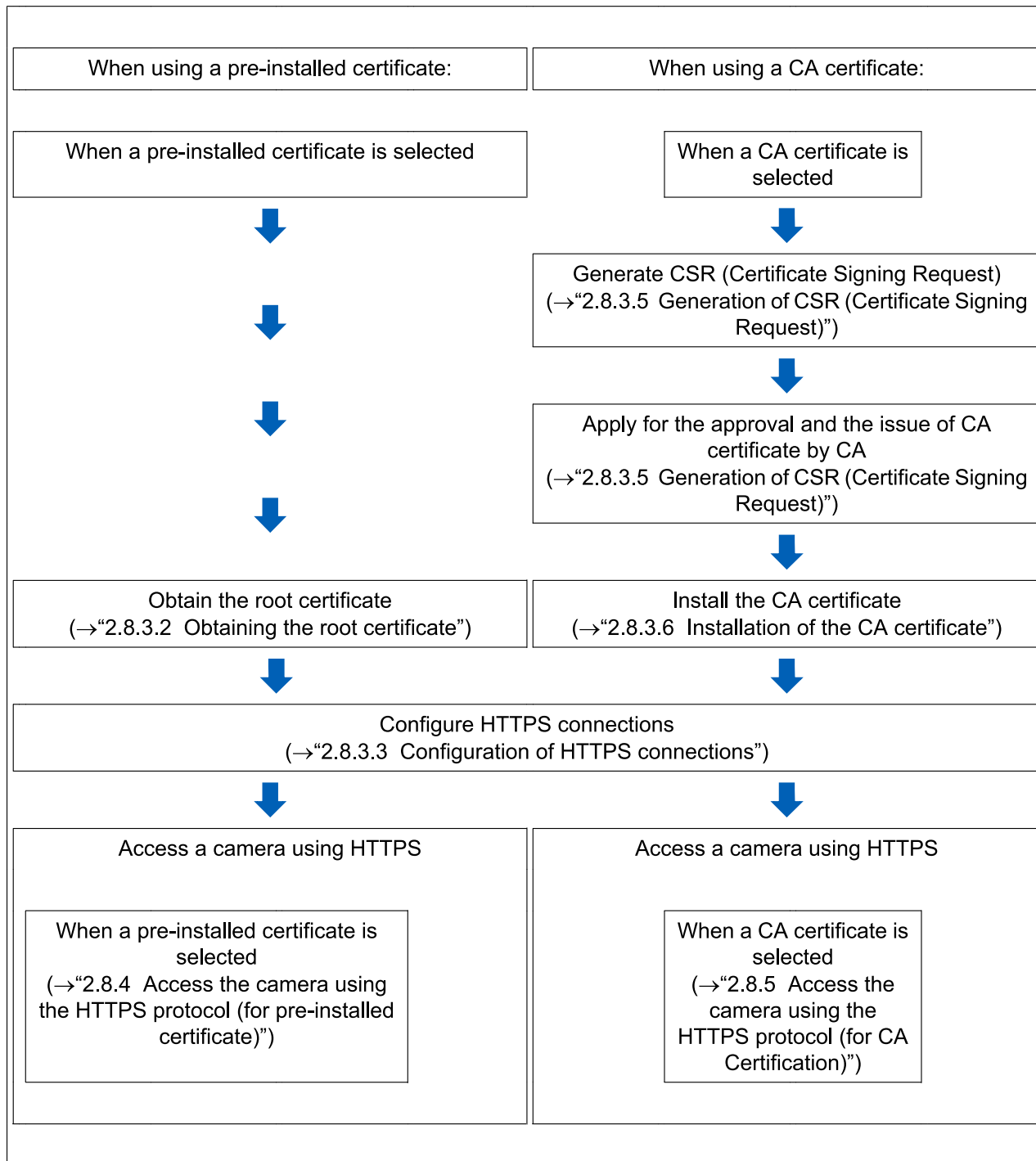

## 2 Settings

The screenshot shows the HTTPS configuration interface. It includes a 'Connection' dropdown set to 'HTTP', a 'Select certificate' dropdown set to 'Pre-installed', and an 'HTTPS port' field set to '443'. Below these are sections for 'Pre-installed certificate' (with a 'Download root certificate' button), 'CA Certificate' (with 'CRT key generate', 'Generate Certificate Signing Request', and 'CA Certificate install' buttons), and an 'Information' section showing 'Invalid' status with 'Confirm' and 'Delete' buttons. Pink lines and numbered circles (1-6) point to the 'Connection' dropdown, 'Select certificate' dropdown, 'Download root certificate' button, 'CRT key generate' button, 'Generate Certificate Signing Request' button, and the 'Browse...' button in the 'CA Certificate install' section, respectively.

- ① Configuring the HTTPS connection (→“2.8.3.3 Configuration of HTTPS connections”)
- ② Select the certificate (→“2.8.3.1 Select the certificate to use when accessing with HTTPS”)
- ③ Obtain the root certificate (→“2.8.3.2 Obtaining the root certificate”)
- ④ Generation of the CRT key (SSL encryption key) (→“2.8.3.4 Generation of the CRT key (SSL encryption key)”)
- ⑤ Generation of CSR (Certificate Signing Request) (→“2.8.3.5 Generation of CSR (Certificate Signing Request)”)
- ⑥ Install the CA certificate (→“2.8.3.6 Installation of the CA certificate”)

### Note

- To use the CA certificate, you need to apply for the approval and the issue of CA certificate by CA.

### 2.8.3.1 Select the certificate to use when accessing with HTTPS

Select the certificate to be used with HTTPS with [HTTPS – Select certificate].

- **When using a pre-installed certificate:** Select “Pre-installed”.  
When “Pre-installed” is selected, a root certificate (→“2.8.3.2 Obtaining the root certificate”) must be obtained.
- **When using a CA certificate:** Select “CA”.

### Note

- “CA” can only be selected when a CA certificate has been added. Refer to “2.8.3 How to configure HTTPS settings” for information on how to add a CA certificate.

### 2.8.3.2 Obtaining the root certificate

This procedure only needs to be done once for each PC that accesses the camera.

1. Access the camera, and click the [Execute] button for “Pre-installed certificate - Download root certificate” under “HTTPS” in the [Advanced] tab in the settings menu of the “Network” page. Click “Open” displayed on the bottom of the browser.

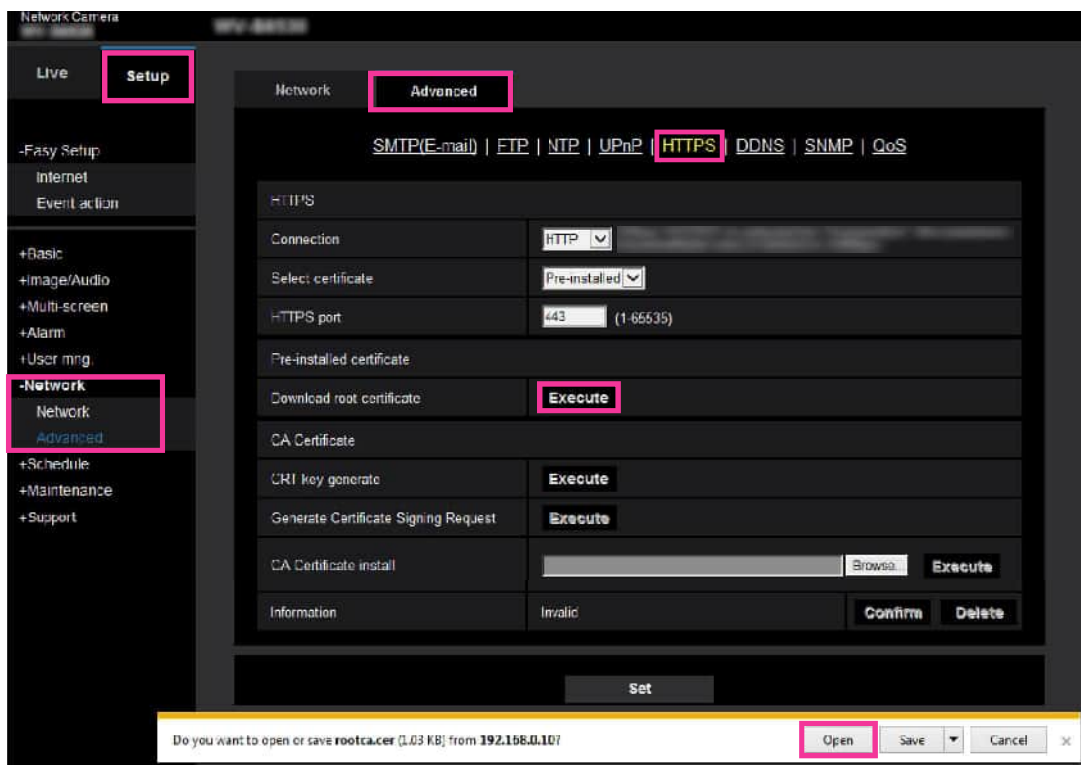

## 2 Settings

---

2. Click “Install Certificate...”.

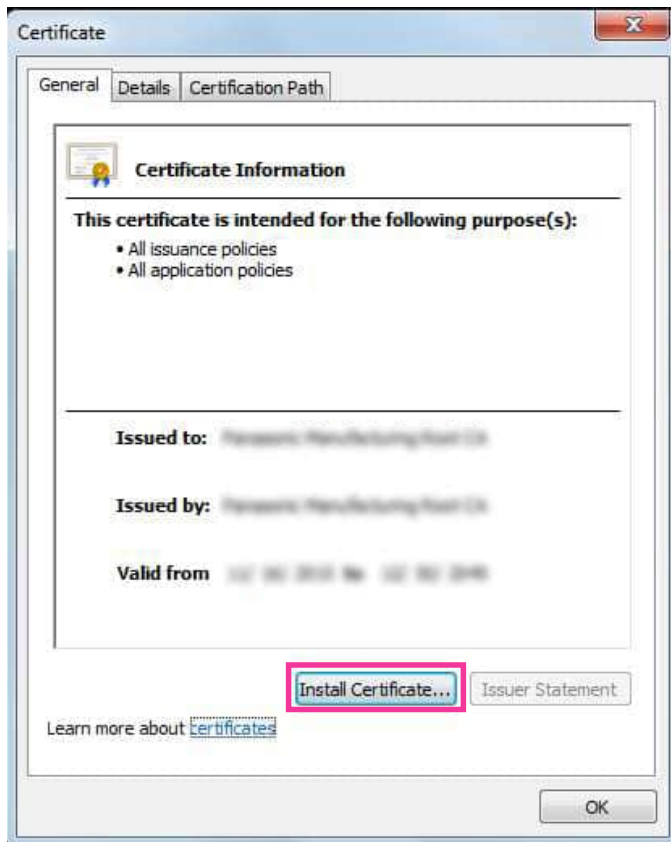

3. Click “Next” displayed in “Certificate Import Wizard”.



4. Select “Place all certificates in the following store”, and click “Browse...”.

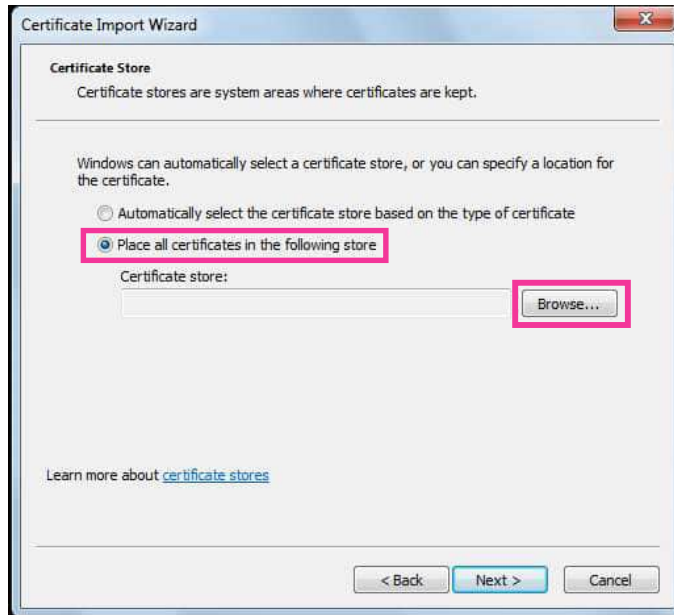

5. Select “Trusted Root Certificate Authorities”, and click “OK”.

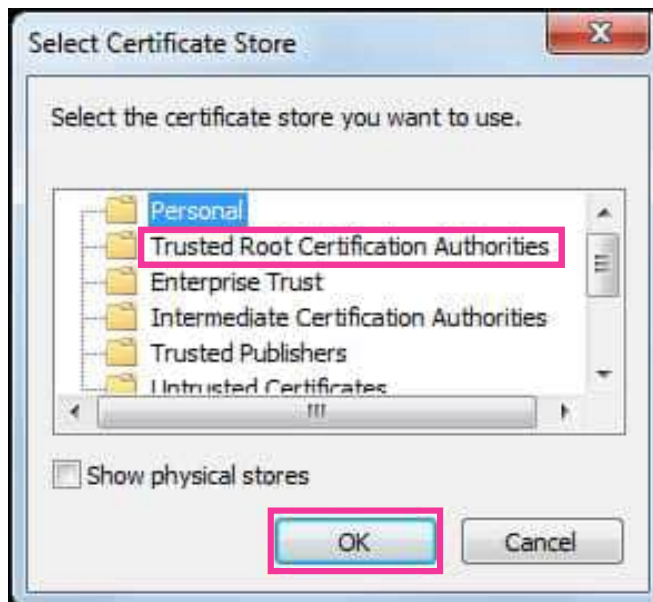

6. Click “Next”.

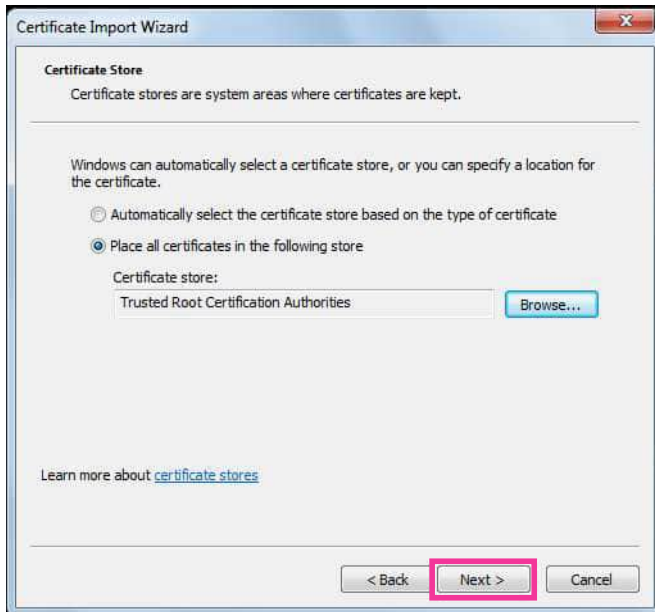

7. Click “Finish”.



8. Confirm that the content shown next to “Thumbprint” in the “Security warning” window is as follows and then click “Yes”.
- Thumbprint (sha1): 0B886A3C E7F2DBA8 1035DDFA 2B21F80B 06778932

**Note**

- Other parties cannot create another thumbprint with the same values. You can confirm that you have retrieved the correct root certificate from the specified camera by confirming the values of the thumbprint.

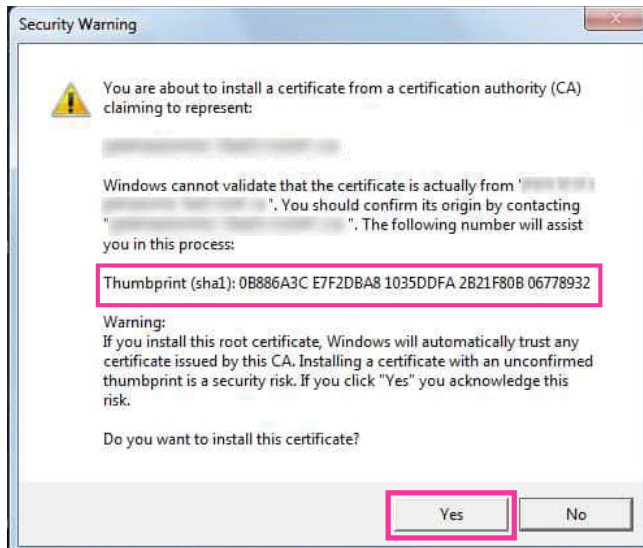

→ When the import is successfully completed, the screen "The import was successful." will be displayed.

9. Click the [OK] button.



10. Click the [OK] button in the “Certificate” window to close the window.

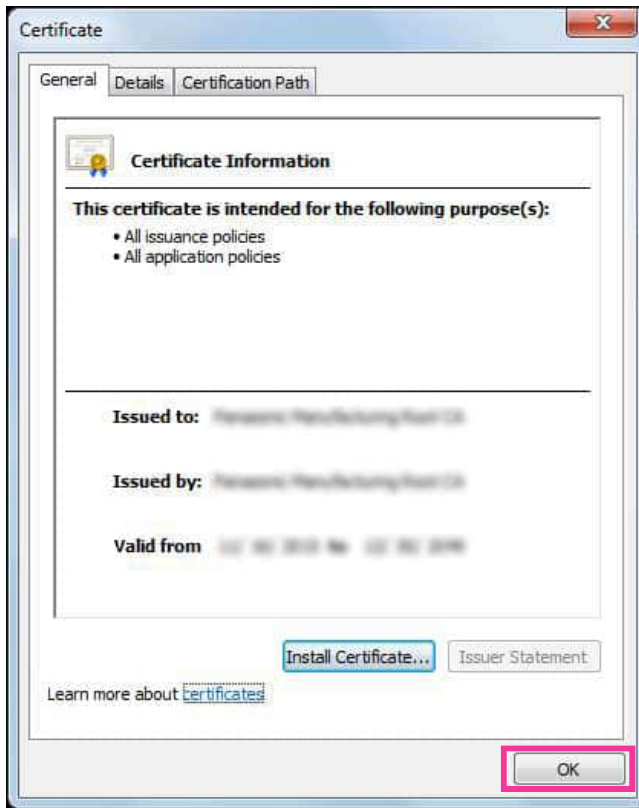

### 2.8.3.3 Configuration of HTTPS connections

1. Select “HTTPS” to access the camera in [HTTPS – Connection].
2. Designate the HTTPS port number to be used for [HTTPS – HTTPS port].
  - **Available port number:** 1 - 65535
  - **Default:** 443

The following port numbers are unavailable since they are already in use.  
20, 21, 23, 25, 42, 53, 67, 68, 69, 80, 110, 123, 161, 162, 554, 995, 10669, 10670, 59000 - 61000
3. Click the [Set] button.
  - It will become possible to access to the cameras using the HTTPS protocol.  
Restart the browser and access again.  
Refer to the following for information on methods to access cameras using HTTPS.
    - **Monitor images on a PC:** 1.1 Monitor images on a PC
    - **Monitor images on a mobile terminal:** 1.2 Monitor images on a mobile terminal/tablet device
4. If “Certificate error” is displayed, refer to the following.
  - **When using a pre-installed certificate:** 2.8.4 Access the camera using the HTTPS protocol (for pre-installed certificate)
  - **When using a CA certificate:** 2.8.5 Access the camera using the HTTPS protocol (for CA Certification)

**Note**

- When the connection setting is changed, after waiting for a while, access the camera again with either “http://IP address of the camera” or “https://IP address of the camera” depending on the changed setting.
- **When using the pre-installed certificate:**  
In advance, install the root certificate of the Pre-installed certificate on the PC in use. Refer to “2.8.3.2 Obtaining the root certificate” for information on the setting procedure.
- When the camera is accessed using the HTTPS protocol, the refresh interval and frame rate of images may be lower.
- When the camera is accessed using the HTTPS protocol, it may take time to display images.
- When the camera is accessed using the HTTPS protocol, the images may be distorted or audio may be interrupted.
- The maximum number of concurrent access user varies depending on the maximum image size and transmission format.

**2.8.3.4 Generation of the CRT key (SSL encryption key)****IMPORTANT**

- When the CA certificate is valid, it is impossible to generate the CRT key.
- When the CA certificate is used, the available key size varies depending on the CA. Confirm the available key size in advance.
- To generate the CRT key, it may take about 2 minutes. Do not operate the web browser until the generation of CRT key is complete. While the CRT key is being generated, the refresh interval and line speed may be lower.

1. Click the [Execute] button of “CRT key generate”.  
→ The “CRT key generate” dialog box will be displayed.

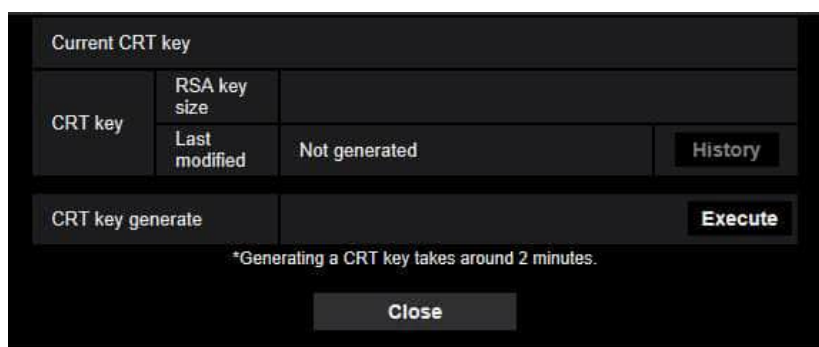

2. Click the [Execute] button.  
→ The generation of CRT key will be started. When the generation is finished, the key size and generation time & date of the generated key will be displayed on “Current CRT key”.

**Note**

- To change (or update) the generated CRT key, perform step 1 to 2. The CRT key and CA certificate are valid in a set. When the CRT key is changed, it is necessary to re-apply for the CA certificate.
- When the CRT key is updated, the log of the previous CRT key is saved. When the [History] button of “Current CRT key” on the “CRT key generate” dialog box is clicked, the “Previous CRT key” dialog box will be displayed, and it is possible to check the key size and generation time & date of the previous

key. When the [Apply] button is clicked on the “Previous CRT key” dialog box, it is possible to replace the current CRT key with the previous one.



### 2.8.3.5 Generation of CSR (Certificate Signing Request)

**IMPORTANT**

- If the CRT key is not generated, it is impossible to generate the CSR.
- Before generating the CSR file, configure the following settings on [Internet Options] of the web browser in advance. Click [Internet Options...] under [Tools] of the menu bar of Internet Explorer, and then click the [Security] tab.
  - Register the camera for [Trusted Sites].
  - Click the [Custom level...] button to open the [Security Settings] window, and check the [Enable] radio button of [File Download] under [Downloads].

1. Click the [Execute] button of “CA Certificate - Generate Certificate Signing Request”.  
 → The “CA Certificate - Generate Certificate Signing Request” dialog box will be displayed.



2. Enter the information of the certificate to be generated.

Item	Description	Available number of characters
[Common Name]	Enter the camera address or host name.	64 characters
[Country]	Enter the country name.	2 characters (Country code)
[State]	Enter the state name.	128 characters

Item	Description	Available number of characters
[Locality]	Enter the locality name.	128 characters
[Organization]	Enter the organization name.	64 characters
[Organizational Unit]	Enter the unit name of the organization.	64 characters
[CRT key]	Displays the key size and generation time & date of the current key.	—

**Note**

- To use the CA certificate, follow the requests from the CA about the information to be entered.
  - The available characters for [Common Name], [State], [Locality], [Organization], [Organizational Unit] are 0-9, A-Z, a-z and the following marks.  
- . \_ , + / ( )
- Click the [OK] button after entering the items.  
→ The [Save As] dialog box will be displayed.
  - Enter a file name for the CSR in the [Save As] dialog box to save on the PC.  
→ The saved CSR file will be applied to the CA.

**IMPORTANT**

- The CA certificate will be issued for the set of the generated CSR and CRT key. If the CRT key is re-generated or updated after applying to the CA, the issued CA certificate will be invalidated.

**Note**

- This camera generates the CSR file in the PEM format.

## 2.8.3.6 Installation of the CA certificate

**IMPORTANT**

- If the CSR file is not generated, it is impossible to install the CA certificate (security certificate).
  - For the installation of the CA certificate, the CA certificate issued by CA is required.
- Click the [Browse...] button of "CA Certificate - CA Certificate install".  
→ The [Open] dialog box will be displayed.
  - Select the CA certificate file and click the [Open] button. Then, click the [Execute] button.  
→ The CA certificate will be installed.

**Note**

- The host name registered in the installed CA certificate will be displayed on "CA Certificate - Information". Depending on the status of the CA certificate, the following are displayed.

Indication	Description
Invalid	The CA certificate is not installed.
[CA certificate Host name]	The CA certificate has already been installed and validated.
Expired	The CA certificate has already expired.

- When the [Confirm] button is clicked, the registered information of the CA certificate (security certificate) will be displayed in the “CA Certificate - Confirm” dialog box. (Only “Organizational Unit” will be displayed with an asterisk (\*).)

CA Certificate - Confirm		
Common Name	NWCAM	
Country	JP	
State	Fukushima	
Locality	Fukushima	
Organization	Panasonic	
Organizational Unit	Software*	
CRT key	RSA key size	2048bit
	Last modified	2016/04/29 17:38
<b>Close</b>		

- When the [Delete] button is clicked, the installed CA certificate (security certificate) will be deleted.
- When “HTTPS” is selected for “Connection”, it is impossible to delete the CA certificate (security certificate).
- To update the CA certificate, perform step 1 and 2.

### **IMPORTANT**

- Before deleting the valid CA certificate (security certificate), confirm that there is a backup file of the CA certificate (security certificate) on the PC or another media. The backup file of the CA certificate (security certificate) will be required when installing the CA certificate (security certificate) again.
- When the CA certificate has expired, the HTTPS function will become unavailable. When the camera is restarted, the connection protocol will be changed to HTTP. Update the CA certificate before it expires.
- The expiration date of the CA certificate can be checked by double-clicking the CA certificate file issued by CA.

## **2.8.4 Access the camera using the HTTPS protocol (for pre-installed certificate)**

When accessing the camera with HTTPS from a browser using the pre-installed certificate, in order to stop a warning message from being played, you must configure your PC by following the steps below. Explanations are based on procedures for Windows 10 using Internet Explorer 11. Procedures for other operating systems or browsers may differ.

### **2.8.4.1 Configuration of the host file**

This procedure must be done on each PC for all the camera that are accessed.

#### **Note**

- The following procedure cannot be used if you are using DDNS.
1. Start the browser and then access the camera using the HTTPS protocol.

- When the security alert window is displayed, click “Continue to this website (not recommended).”

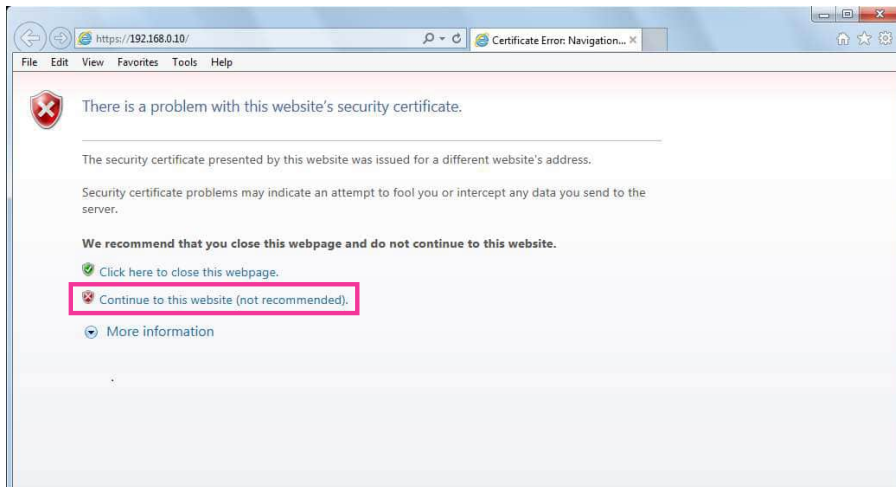

→The “Live” page will be displayed. If an authentication window is displayed, enter the user name and password.

#### Note

- This warning is displayed because the text entered in the address box does not match the text displayed in the subject of the certificate. This type of warning is displayed because when the certificate for the pre-installed certificate is created, the IP address or domain name assigned to the camera has not been determined yet. However, because the certificate configured in “2.8.3.2 Obtaining the root certificate” is only issued for our products, this is not a problem.
- Click “Certificate error” over the URL, and click “View certificates” on the bottom of the “Mismatched Address” window.

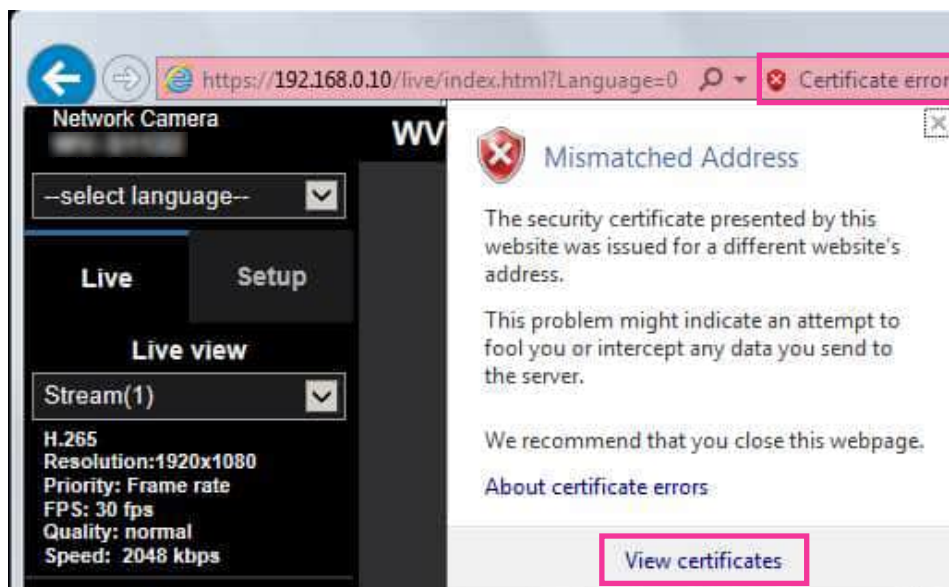



5. Confirm <All> that is displayed for “Show” and then click “Subject” in the field. Copy the text shown after “CN=” in the lower box.

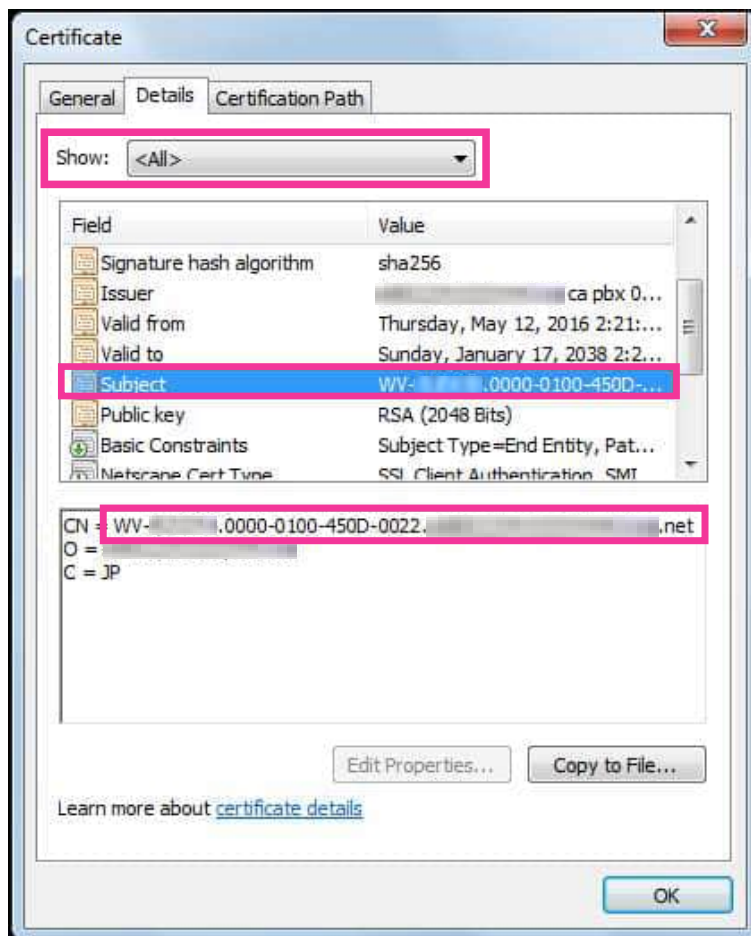

## 2 Settings

- From the Start menu enter the following text in the “Search programs and files” text box and then press [Ctrl], [Shift], and [Enter] at the same time.  
notepad C:\Windows\System32\drivers\etc\hosts

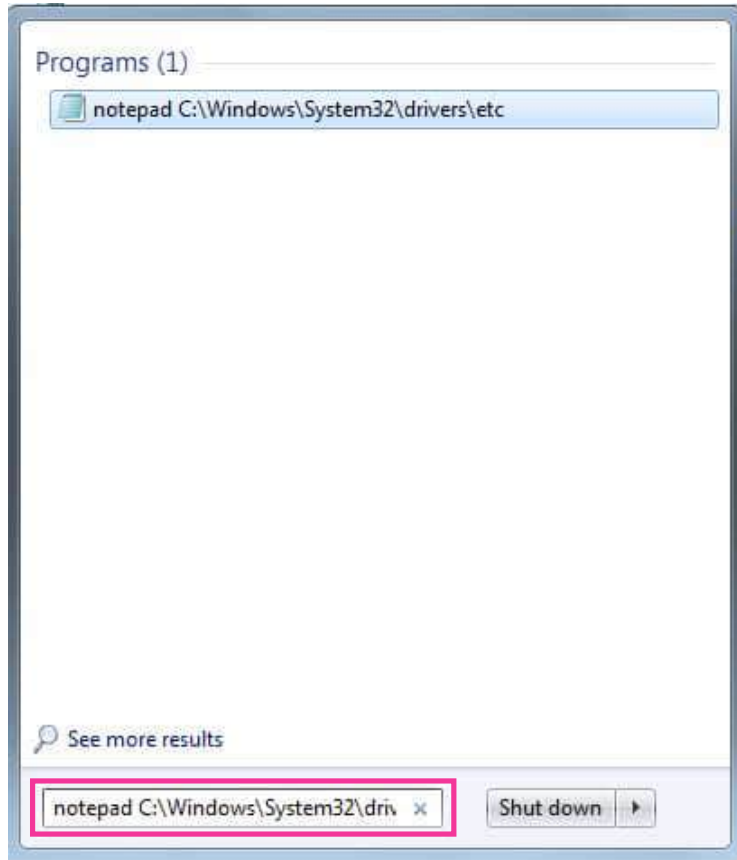

- If the “User Account Control” window is displayed, select “Yes”.
- The “hosts - Notepad” window is opened. Add the following text to the end of the file.  
(camera IP address) (copied text from step 5)  
The example is when the IP address is “192.168.0.10” and the CN of the camera is “WV-xxxxxx.0000-0100-450D-0022.xxxxxx-security-system.net”.

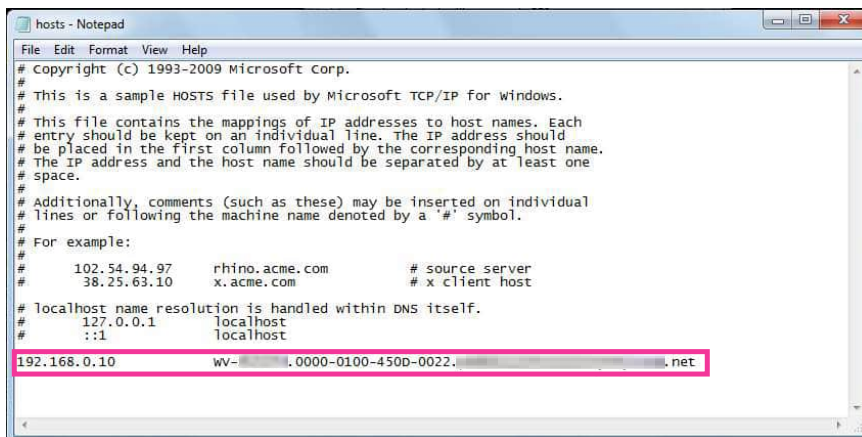

- Select “File” → “Save” to save the file and then close the file.

10. When accessing with a browser, add the following text for the CN after entering “https://” in the “address” box.

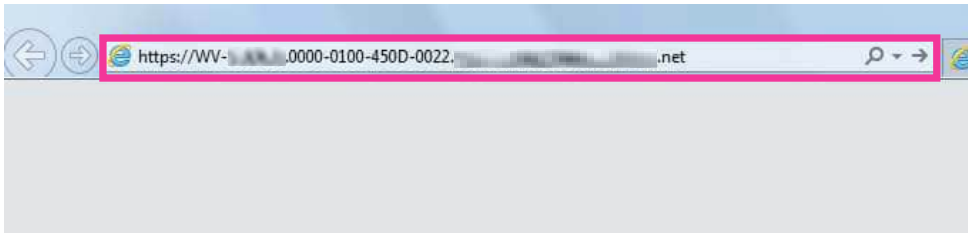

### IMPORTANT

- When the HTTPS port number is changed from “443”, enter “the following text for CN + : (colon) + port number” in the address box of the browser.  
Example of when the port number is “61443”:  
`https://WV-xxxxxx.0000-0100-450D-0022.xxxxxx-security-system.net:61443`
- We recommend adding the camera's URL to your browser's bookmark. If you forget the camera's URL, refer to the hosts file.

11. When the settings are completed, the color of the background of the address box changes to white. Confirm that “Website Identification” is displayed after clicking the key mark on the right side of the address bar.

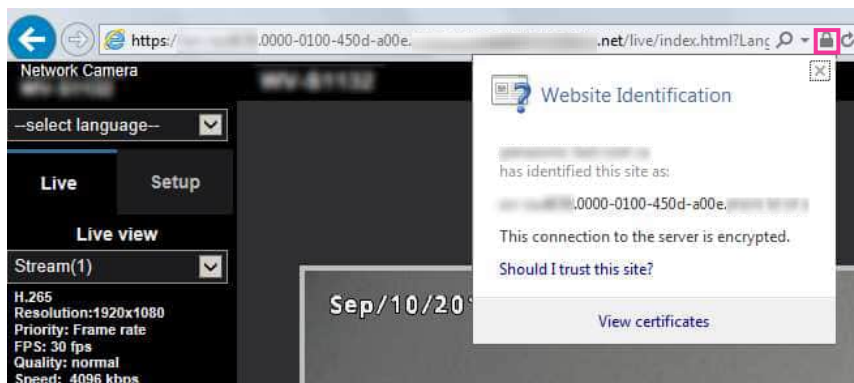

### Note

- If you cannot access with this method it may be because of proxy server settings. Ask the network administrator.

### IMPORTANT

- When the camera is accessed using the HTTPS protocol, the refresh interval and frame rate of images may be lower.

## 2.8.5 Access the camera using the HTTPS protocol (for CA Certification)

1. Start up the web browser.
2. Enter the IP address of the camera in the address box of the browser.
  - **Example of entry:** `https://192.168.0.10/`

### **IMPORTANT**

- When the HTTPS port number is changed from “443”, enter “https://IP address of the camera + : (colon) + port number” in the address box of the browser.  
(**Example:** https://192.168.0.11:61443)
  - When the camera is in a local network, configure the proxy server setting of the web browser (under [Internet Options...] under [Tools] of the menu bar) to bypass the proxy server for the local address.
3. Press the [Enter] key on the keyboard.  
→ The “Live” page will be displayed.

### **IMPORTANT**

- When the camera is accessed using the HTTPS protocol, the refresh interval and frame rate of images may be lower.

## 2.8.6 How to configure the settings relating to DDNS

When activating the DDNS function using the camera, either of the following DDNS services is available.

- “Viewnetcam.com” service
- Dynamic DNS Update (RFC2136 compliant)

### **IMPORTANT**

- Before using the DDNS service, it is necessary to perform the port forwarding setting for the router.
- **About Dynamic DNS Update (RFC2136 compliant)**  
Operation using DDNS services other than the “Viewnetcam.com” service is not guaranteed. We are not responsible for any troubles or accidents on the circumstances where the camera is used arising out of such services.  
Refer to the DDNS service providers for the selection and configuration of the DDNS services other than the “Viewnetcam.com” service.

### **Note**

- “Viewnetcam.com” is a Dynamic DNS service designed for use with our network cameras. Refer to the “Viewnetcam.com” website (<http://www.viewnetcam.com/>) for further information about the service.

## About DDNS services (IPv4/IPv6)

By using a DDNS service, it becomes possible to view camera images via the Internet.

The DDNS service associates dynamic global addresses and domain names.

It is possible to configure the settings for the “Viewnetcam.com” or Dynamic DNS Update (RFC2136 compliant). In most of the DNS services offered by providers, global addresses are not static but dynamic. Therefore, access to the camera via an old global address may be invalidated after a certain period of time. Either of the following services is required when accessing a camera whose global address is not static via the Internet.

- **DDNS service (such as “Viewnetcam.com”)**  
It is possible to access via a registered and static domain name (example: \*\*\*\*\*.viewnetcam.com) even after the global address is changed. Enrollment in a domain name service is required even when using the IPv6 connection.  
Refer to the “Viewnetcam.com” website (<http://www.viewnetcam.com/>) for further information about the service.
- **Static IP address service (such as a service offered by a contracted provider)**  
In this service, global addresses are static (not changed).

## Configuration of the DDNS service (Example of the “Viewnetcam.com” service)

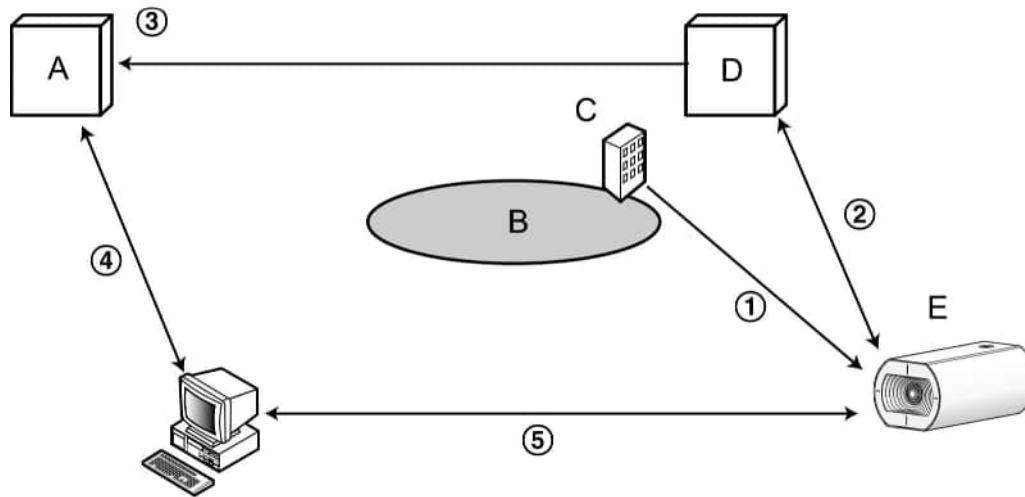

- A. DNS server
- B. Internet
- C. Provider
- D. “Viewnetcam.com” service server
- E. Remote site

① **Global address is changed.**

The contracted provider allocates a global address to the router (or the camera). The global address is not static but dynamic.

② **“\*\*\*\*\*.viewnetcam.com” and the current global address is automatically registered.**

If you are enrolled in “Viewnetcam.com”, the unique “domain name” (example: \*\*\*\*\*.viewnetcam.com) will be allocated. The “Viewnetcam.com” service server automatically manages the domain name of camera and the global address of router (or camera) when a camera automatically notifies the service server of the global address.

③ **Current global address is automatically registered via “\*\*\*\*\*.viewnetcam.com”.**

The “Viewnetcam.com” service server registers the global address and the domain name of router (or camera) in the DNS server.

④ **Global address is obtained via the URL (domain name).**

By entering the URL (including the domain name) on the web browser when accessing the camera via the Internet, the DNS server identifies the registered global address of router (or camera).

⑤ **Access using the current global address**

The identified global address is used for accessing the router (or camera) to monitor images.

### Note

- Refer to the contracted provider whether the current IP address is static or not.
- Depending on the provider, local addresses may be allocated. In this case, the DDNS service is unavailable. Refer to the contract provider for further information.

### 2.8.6.1 When using the “Viewnetcam.com” service

DDNS	
Area	Global
Service	Viewnetcam.com
Personal(Camera) URL	
Your Account Link	
Access Interval	1h
Global IP Address Notification Method	<input checked="" type="radio"/> Normal <input type="radio"/> Advanced

**Set**

#### [Personal(Camera) URL]

The URL of the camera registered for “Viewnetcam.com”.

#### [Your Account Link]

When the displayed URL is clicked, the registration window for the “Viewnetcam.com” service will be displayed in a newly opened window.

Register the information in the registration window to enroll in the “Viewnetcam.com” service.

#### [Access interval]

Select the interval to access the “Viewnetcam.com” service server to check the IP address and the host name from the following.

10min/ 20min/ 30min/ 40min/ 50min/ 1h

- **Default:** 1h

#### [Global IP Address Notification Method]

Typically [Global IP Address Notification Method] should be set to “Normal”.

If you cannot access the camera using the registered URL 30 minutes after registering with “Viewnetcam.com”, select “Advanced”.

In this case, UPnP (→“2.8.2.3 Configure the UPnP settings”) must be enabled for the camera and for the router.

- **Default:** Normal

### Procedure to register information for the “Viewnetcam.com” service

1. Select [Viewnetcam.com] for [Service] and click the [Set] button.
  - A URL is displayed in [Your Account Link].
  - If a URL is not displayed in [Your Account Link], confirm the camera's network settings and Internet connection, then click [Set] again.
2. Register the information for “Viewnetcam.com” by following the instructions of the wizard.
  - The registration window for “Viewnetcam.com” will be displayed in a newly opened window.

When the registration window is not displayed, check that the PC is being connected to the Internet, and click the reload button of the browser.

DDNS	
Area	Global
Service	Viewnetcam.com
Personal(Camera) URL	
Your Account Link	http://:*****
Access interval	1h
Global IP Address Notification Method	<input type="radio"/> Normal <input checked="" type="radio"/> Advanced

**3.** Register the information for “Viewnetcam.com” by following the instructions of the wizard.

→ When the message “The new camera is successfully registered to Viewnetcam.com” is displayed, close the registration window.

The URL set at the time of registration can be used for camera access. However, this URL is unavailable when accessing the camera from the PC connected to the same network (LAN).

DDNS	
Area	Global
Service	Viewnetcam.com
Personal(Camera) URL	*****
Your Account Link	http://:*****
Access interval	1h
Global IP Address Notification Method	<input type="radio"/> Normal <input checked="" type="radio"/> Advanced

**Note**

- When the registration for the “Viewnetcam.com” service is completed, the URL registered for “Personal(Camera) URL” is displayed. It may take up to about 30 minutes until the URL of the registered camera is validated.
- To cancel the enrollment in the “Viewnetcam.com” service, access the “Viewnetcam.com” website (<http://www.viewnetcam.com/>) later.
- When “Expired” is displayed in the URL of “Viewnetcam.com” in the viewnetcam settings page or the status page, restart the camera after registering the “Viewnetcam.com” service. After restarting the camera, check that the registered URL is displayed in the URL of “Viewnetcam.com” of [Status] - [Viewnetcam.com] on the “Maintenance” page.
- It is possible to check the information registered for the “Viewnetcam.com” service by accessing the URL displayed beside “Your Account Link”. When the URL is not displayed, check that the PC is being connected to the Internet, and click the [Set] button.
- If access often fails due to the change in the global address of router, set a smaller value for “Access interval”.

### Checking the information registered for the “Viewnetcam.com” service

It is possible to check if the camera has been registered for the “Viewnetcam.com” service. (→“2.10.3 Check the status [Status]”)

#### 2.8.6.2 When using “Dynamic DNS Update”

The screenshot shows the 'Advanced' tab of the network settings. Under the 'DDNS' section, the 'Service' is set to 'Dynamic DNS Update'. The 'Area' is set to 'Global' and the 'Access interval' is set to '24h'. The 'Host name' field is empty. Below the form, there is a 'Set' button and a disclaimer: 'Technical knowledge about networking construction and how to use ONVIF® conformant products is required for using this function. Please confirm with the company providing such service or the person in charge of network construction. Please note that our company does not provide any support regarding specific commands or the method of use related to ONVIF conformant products. ONVIF is a trademark of Onvif, Inc.'

#### [Host name]

Enter the host name to be used for the Dynamic DNS Update service.

- **Available number of characters:** 3 - 250 characters  
Enter in the form of “(host name). (domain name)”.
- **Available characters:** Alphanumeric characters, the period (.), and the hyphen (-).
- **Default:** None (blank)

#### Note

- Refer to the network administrator for further information about the available host names.

#### [Access interval]

Select the interval to access the Dynamic DNS Update service server to check the IP address and the host name from the following.

10min/ 20min/ 30min/ 40min/ 50min/ 1h/ 6h/ 24h

- **Default:** 24h

### 2.8.6.3 When using “Dynamic DNS Update(DHCP)”

The screenshot shows the 'Advanced' settings page for DDNS. The 'Service' dropdown is set to 'Dynamic DNS Update(DHCP)'. The 'Host name' field is empty. Below the form, there is a disclaimer: 'Technical knowledge about networking construction and how to use ONVIF@ conformant products is required for using this function. Please confirm with the company providing such service or the person in charge of network construction. Please note that our company does not provide any support regarding specific commands or the method of use related to ONVIF conformant products. ONVIF is a trademark of Onvif, Inc.' A 'Set' button is located at the bottom right of the form.

#### [Host name]

Enter the host name to be used for the Dynamic DNS Update service.

- **Available number of characters:** 3 - 250 characters  
Enter in the form of “(host name). (domain name)”.
- **Available characters:** Alphanumeric characters, the period (.), and the hyphen (-).
- **Default:** None (blank)

#### Note

- Refer to the network administrator for further information about the available host names.

## 2.9 Configure the settings relating to the schedules [Schedule]

On the “Schedule” page, it is possible to configure the settings relating to schedules as follows.

- VMD permission
- SCD permission
- Access permission
- SD memory recording
- Scene file
- Allow e-mail transmission
- Reboot (Schedule 5 only)

The “Schedule” page has only the [Schedule] tab.

Up to 5 schedules can be set.

The screenshot displays the 'Schedule' configuration page. It features five schedule entries, each with a unique color and a 'Schedule mode' dropdown menu currently set to 'Off'. The 'Time range' for each schedule is configured with checkboxes for days of the week (Mon-Sun) and a 24-hour time range selector. Below the entries is a 24-hour timeline grid for each day of the week. A 'Set' button is located at the bottom of the interface.

The color of each schedule is not linked with the area color of "VMD area".  
 When "VMD permission" is set, the VMD functions in all the areas set with "VMD area".  
 "VMD permission" and "SCD permission" are required when assigning the period to be detected. Setting is not necessary when detection at any time.

1. Select an action to be assigned to the schedule from "Schedule mode".  
 "Off" is selected at the default.
  - **Off:** No action will be taken for the respective schedule.
  - **VMD permission:** The VMD function will be active during the period of the schedule. Schedule settings are not required when continuously using VMD.
  - **SCD permission:** The SCD function will be active during the period of the schedule. Schedule settings are not required when continuously using SCD.

- **Access permission:** Users whose access level is set to “2. Camera control” and “3. Live only” on the [User auth.] tab (→“2.7.1 Configure the settings relating to the user authentication [User auth.]”) can access the camera only in the period of schedule.
- **Recording to SD (Recording stream):** The SD recording configured in “Recording stream” will be performed at the designated time in the schedule. Only available when a stream is selected in “Recording format”.
- **Image adjust 1: Scene 1:** Images are set to the image settings of “Scene file 1” at the designated time in the schedule. When the designated time for the schedule finishes, images are set to the image settings of “Scene file is not applied”.
- **Image adjust 1: Scene 2:** Images are set to the image settings of “Scene file 2” at the designated time in the schedule. When the designated time for the schedule finishes, images are set to the image settings of “Scene file is not applied”.
- **Image adjust 1: Scene 3:** Images are set to the image quality settings of “Scene file 3” at the designated time in the schedule. Once designated time in the schedule is over, the image quality setting is set to “Scene file is not applied”.
- **Image adjust 1: Scene 4:** Images are set to the image quality settings of “Scene file 4” at the designated time in the schedule. Once designated time in the schedule is over, the image quality setting is set to “Scene file is not applied”.
- **E-mail permission:** While the schedule is set, e-mail notification is sent when alarm is input.
- **Reboot:** The camera reboots at the scheduled time. Can only be selected with Schedule 5.

### **Note**

- Select “On” for “User auth.” on the [User auth.] tab of “User mng.” page (→“2.7.1 Configure the settings relating to the user authentication [User auth.]”) and “Off” for “Host auth.” on the “Host auth.” page (→“2.7.2 Configure the settings relating to the host authentication [Host auth.]”) to validate “Access permission”.
  - When selecting “Recording to SD(Recording stream)”, select “Stream(1)”, “Stream(2)”, or “Stream(3)” for “Recording format” on the [SD memory card] tab and select “Schedule” for “Save trigger”. (→[Save trigger])
2. Select days of a week by checking the respective checkboxes.
  3. From the pull-down menu, select the start time and the end time of the schedule.  
When not designating time, check the checkbox of “24h”.

4. Click the [Set] button after completing the settings.  
 → The result will be displayed at the bottom of the window.

The screenshot displays the 'Schedule' configuration interface. It contains five schedule entries, each with a unique color and specific settings:

- Schedule 1 (White):** Schedule mode: VMD permission. Time range: Mon-Sun, 09:00 - 17:30.
- Schedule 2 (Blue):** Schedule mode: SCD permission. Time range: Mon-Sun, 23:00 - 07:00.
- Schedule 3 (Green):** Schedule mode: Recording to SD (Recording stream). Time range: Mon-Sun, 00:00 - 00:00 (24h).
- Schedule 4 (Red):** Schedule mode: Off. Time range: Mon-Sun, 00:00 - 00:00 (24h).
- Schedule 5 (Black):** Schedule mode: Off. Time range: Mon-Sun, 00:00 - 00:00 (24h).

Below the settings is a 24-hour timeline (0:00 to 24:00) for each day of the week. The active periods are shown as horizontal bars:
 

- White bars (VMD permission) are active from 09:00 to 17:30 on all days.
- Blue bars (SCD permission) are active from 23:00 to 07:00 on all days.
- Green bars (Recording to SD) are active for the entire 24-hour period on all days.
- Red and black bars (Off) are not visible, indicating no active periods.

The color of each schedule is not linked with the area color of "VMD area".  
 When "VMD permission" is set, the VMD functions in all the areas set with "VMD area".  
 "VMD permission" and "SCD permission" are required when assigning the period to be detected. Setting is not necessary when detection at any time.

**Set**

**Note**

- The schedules displayed at the bottom of the window can be identified by colors assigned to each schedule.

## 2.9.1 How to delete the set schedule

The screenshot displays the 'Schedule' configuration window. It contains a table of five schedules and a weekly schedule bar chart below it.

Schedule Name	Schedule Mode	Time Range
Schedule 1 (White)	VMD permission	24h 09:00 - 17:30
Schedule 2 (Blue)	SCD permission	24h 23:00 - 07:00
Schedule 3 (Green)	Recording to SD (Recording stream)	24h 00:00 - 00:00
Schedule 4 (Red)	Off	24h 00:00 - 00:00
Schedule 5 (Black)	Off	24h 00:00 - 00:00

The weekly schedule bar chart shows the following active periods (indicated by colored bars):

- Monday:** 00:00-06:00 (Blue), 12:00-18:00 (White), 24:00-00:00 (Blue)
- Tuesday:** 00:00-06:00 (Blue), 12:00-18:00 (White), 24:00-00:00 (Blue)
- Wednesday:** 00:00-06:00 (Blue), 12:00-18:00 (White), 24:00-00:00 (Blue)
- Thursday:** 00:00-06:00 (Blue), 12:00-18:00 (White), 24:00-00:00 (Blue)
- Friday:** 00:00-06:00 (Blue), 12:00-18:00 (White), 24:00-00:00 (Blue)
- Saturday:** 00:00-06:00 (Blue), 00:00-24:00 (Green)
- Sunday:** 00:00-06:00 (Blue), 00:00-24:00 (Green)

The color of each schedule is not linked with the area color of "VMD area".  
When "VMD permission" is set, the VMD functions in all the areas set with "VMD area".  
"VMD permission" and "SCD permission" are required when assigning the period to be detected. Setting is not necessary when detection at any time.

**Set**

1. Uncheck the check box of the set day of the week.

2. Click the [Set] button after completing the settings.  
 → The schedule of the selected day of the week is deleted.

Schedule
Schedule

Schedules

Schedule 1 (White) <span style="color: white;">■</span>	Schedule mode: <span style="border: 1px solid #ccc; padding: 2px;">VMD permission</span>
	Time range: <input type="checkbox"/> Mon <input type="checkbox"/> Tue <input type="checkbox"/> Wed <input type="checkbox"/> Thu <input type="checkbox"/> Fri <input type="checkbox"/> Sat <input type="checkbox"/> Sun <input checked="" type="checkbox"/> 24h <span style="border: 1px solid #ccc; padding: 2px;">09:00</span> - <span style="border: 1px solid #ccc; padding: 2px;">17:30</span>
Schedule 2 (Blue) <span style="color: blue;">■</span>	Schedule mode: <span style="border: 1px solid #ccc; padding: 2px;">SCD permission</span>
	Time range: <input type="checkbox"/> Mon <input type="checkbox"/> Tue <input type="checkbox"/> Wed <input type="checkbox"/> Thu <input type="checkbox"/> Fri <input type="checkbox"/> Sat <input type="checkbox"/> Sun <input checked="" type="checkbox"/> 24h <span style="border: 1px solid #ccc; padding: 2px;">23:00</span> - <span style="border: 1px solid #ccc; padding: 2px;">07:00</span>
Schedule 3 (Green) <span style="color: green;">■</span>	Schedule mode: <span style="border: 1px solid #ccc; padding: 2px;">Recording to SD (Recording stream)</span>
	Time range: <input type="checkbox"/> Mon <input type="checkbox"/> Tue <input type="checkbox"/> Wed <input type="checkbox"/> Thu <input type="checkbox"/> Fri <input type="checkbox"/> Sat <input type="checkbox"/> Sun <input checked="" type="checkbox"/> 24h <span style="border: 1px solid #ccc; padding: 2px;">00:00</span> - <span style="border: 1px solid #ccc; padding: 2px;">00:00</span>
Schedule 4 (Red) <span style="color: red;">■</span>	Schedule mode: <span style="border: 1px solid #ccc; padding: 2px;">Off</span>
	Time range: <input type="checkbox"/> Mon <input type="checkbox"/> Tue <input type="checkbox"/> Wed <input type="checkbox"/> Thu <input type="checkbox"/> Fri <input type="checkbox"/> Sat <input type="checkbox"/> Sun <input checked="" type="checkbox"/> 24h <span style="border: 1px solid #ccc; padding: 2px;">00:00</span> - <span style="border: 1px solid #ccc; padding: 2px;">00:00</span>
Schedule 5 (Black) <span style="color: black;">■</span>	Schedule mode: <span style="border: 1px solid #ccc; padding: 2px;">Off</span>
	Time range: <input type="checkbox"/> Mon <input type="checkbox"/> Tue <input type="checkbox"/> Wed <input type="checkbox"/> Thu <input type="checkbox"/> Fri <input type="checkbox"/> Sat <input type="checkbox"/> Sun <input checked="" type="checkbox"/> 24h <span style="border: 1px solid #ccc; padding: 2px;">00:00</span> - <span style="border: 1px solid #ccc; padding: 2px;">00:00</span>

	0:00	6:00	12:00	18:00	24:00
Mon					
Tue					
Wed					
Thu					
Fri					
Sat					
Sun					

The color of each schedule is not linked with the area color of "VMD area".  
 When "VMD permission" is set, the VMD functions in all the areas set with "VMD area".  
 "VMD permission" and "SCD permission" are required when assigning the period to be detected. Setting is not necessary when detection at any time.

Set

## 2.10 Maintenance of the camera [Maintenance]

System log check, firmware upgrade, status check and initialization of the setup menu can be performed on this page.

The “Maintenance” page has the [System log] tab, the [Upgrade] tab, [Status] tab, the [Default reset] tab, and the [Data] tab.

### 2.10.1 Check the system log [System log]

Click the [System log] tab of the “Maintenance” page. (→For menu display and how to operate, refer to “2.2.1 How to display the setup menu”, “2.2.2 How to operate the setup menu”)

Up to 4,000 system logs can be saved on the SD memory card when the SD memory card is inserted after selecting “Use” for “SD memory card” on the [SD memory card] tab (→“2.4.2 Configure the settings relating to the SD memory card [SD memory card]”).

When “Not use” is selected for “SD memory card”, up to 100 system logs can be saved on the built-in memory of the camera.

When the saved system logs have reached the maximum number, the newer logs will overwrite the older system logs. In this case, the oldest log is the first to be overwritten.

The system logs will be displayed in group of 100 logs each, and the logs will be saved even when the power of the camera is turned off.

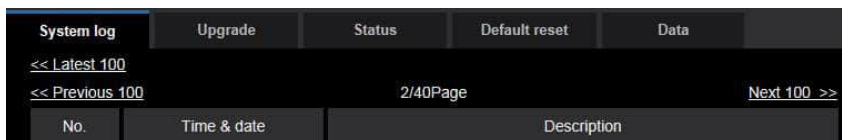

#### [<< Latest 100]

When clicking “<< Latest 100”, the latest 100 system logs will be displayed.

#### [Next 100 >>]

When clicking “Next 100 >>”, the next 100 system logs will be displayed.

#### [Number of pages display]

The currently opened page will be displayed in the “page/total page” format.

#### [<< Previous 100]

When clicking “<< Previous 100”, the previous 100 system logs will be displayed.

#### [No.]

The serial number of the system log will be displayed.

#### [Time & date]

Time and date at the system log will be displayed.

#### [Description]

The descriptions about the system log will be displayed. Refer to “3.1 About the displayed system log” for further information about the system logs.

### 2.10.2 Upgrade the firmware [Upgrade]

Click the [Upgrade] tab of the “Maintenance” page. (→For menu display and how to operate, refer to “2.2.1 How to display the setup menu”, “2.2.2 How to operate the setup menu”)

The current firmware can be checked and upgraded to the latest version on this page. Contact the dealer for further information about the firmware upgrade.

System log	Upgrade	Status	Default reset	Data
Model no.		XXXXXXXXXX		
MAC address		XXXXXXXXXX		
Serial no.		XXXXXXXXXX		
Firmware version		1.00		
IP address(IPv6)	Linklocal	FE80::XXXXXX		
	Static			
	RA			
	DHCPv6			
Viewer software installation counter		1		
Time past from the date of manufacture		XXXXXXXXXX		

Browse...

Reset the settings to the default after completing the upgrade.  
(Except the network settings) **Execute**

Do not reset the settings to the default after the upgrade.

Resets to default HTML data after completing the upgrade.

Download the latest firmware from the following our website.  
Note: Internet connection required to view this page.  
- In case of using outside of Japan.  
XXXXXXXXXX

- In case of using in Japan.  
XXXXXXXXXX

It will take around 5 minutes to complete the upgrade.  
Please wait and do not operate the browser during this process.

**[Model no.], [MAC address], [Serial no.], [Firmware version], [IP address(IPv6)], [Viewer software installation counter], [Time past from the date of manufacture]**

Information of each item will be displayed.

1. Contact the dealer and download the latest firmware onto a PC.

### **IMPORTANT**

- A blank (space) cannot be used for the name of the directory where the downloaded firmware to be saved.

2. Click the [Browse...] button and designate the downloaded firmware.

### **Note**

- The latest firmware upgrade is posted on our website.  
[https://i-pro.com/global/en/surveillance/training\\_support/support](https://i-pro.com/global/en/surveillance/training_support/support)

3. Click the radio button respective to the desired option to determine whether or not to initialize the settings after completing the firmware upgrade.

**Default:** Do not reset the settings to the default after the upgrade.

### Note

- Note that the settings cannot be restored after an initialization is operated.

#### 4. Click the [Execute] button.

→ The confirmation window will be displayed.

### IMPORTANT

- After upgrading, make sure to check the version on this page.
- After completing the upgrade, delete temporary internet files. (→“3.2 Troubleshooting”)
- Upgrade the firmware using a PC in the same subnet as the unit.
- Follow the instructions from the dealer when upgrading the firmware.
- When upgrading the application software, use the designated file (extension: img) for the firmware upgrade.  
The name of the firmware to be used for the upgrade should be “model name (Use small letters. “WV-” is not required.)\_xxxxx.img”.  
\* (“xxxxx” indicates the version of the firmware.)
- Do not turn off the power of the camera during the upgrade process.
- Do not perform any operation during upgrading and wait until it completes.
- The following network settings will not be reset when upgrading the firmware after selecting “Reset the settings to the default after completing the upgrade. (Except the network settings)”.  
Primary server address and secondary server address DNS settings for IPv4, primary DNS server address and secondary DNS server address settings for IPv6, On/Off for DHCP, IP address, subnet mask, default gateway, HTTP port, HTTPS port, connection protocol (HTTP/HTTPS), CRT key, CA certificate, UPnP setting, line speed, bandwidth control (bit rate), time & date, IEEE 802.1X setting.
- The viewer software used on each PC should be licensed individually. Refer to your dealer for the software licensing.

### 2.10.3 Check the status [Status]

Click the [Status] tab of the “Maintenance” page. (→For menu display and how to operate, refer to “2.2.1 How to display the setup menu”, “2.2.2 How to operate the setup menu”)

The status of this camera can be checked on this page.

System log		Upgrade		Status		Default reset		Data	
Viewnetcam.com									
Server		www.viewnetcam.com							
Status		Enabled							
Personal(Camera) URL									
UPnP									
Port number(HTTP)		-							
Status		Enabled							
Port number(HTTPS)		-							
Status		Enabled							
Router global address									
Self check									
Hardware1		00000000000000000000000000000000							
Hardware2		00000000000000000000000000000000							
SD memory card									
Model no.		SD-100							
Serial no.		12345678901234567890123456789012							
Remaining capacity		10000000000000000000000000000000							
Total use time		10000000000000000000000000000000							
Number of overwrite times		1							
No.	Time & date	Description							
1	2023/01/01 00:00:00	SD-100							

## Viewnetcam.com

### [Server]

The URL of the “Viewnetcam.com” service server will be displayed.

### [Status]

The registration status for the “Viewnetcam.com” will be displayed.

### [Personal(Camera) URL]

The URL of the camera registered for “Viewnetcam.com” will be displayed.

## UPnP

### [Port number(HTTP), Port number(HTTPS)]

The port number that is set for UPnP port forwarding will be displayed.

### **[Status]**

The port forwarding status will be displayed.

### **[Router global address]**

The global address of router will be displayed.

## Self check

The self check result of the hardware will be displayed.

### **Note**

- Refer to our website <Control No.:C0111> for further information about the contents of the displayed statuses (relating to the “Viewnetcam.com” service, the UPnP function, or the self check).

## SD memory card

### **[Model no.]**

Displays the model number of the SD memory card.

If model number information could not be obtained, “Read error” is displayed. If the SD memory card is not used, “Not use” is displayed. In other cases “Unknown” is displayed.

### **[Serial no.]**

Displays the serial number of the SD memory card.

If the serial number information could not be obtained, “Unknown” is displayed.

### **[Remaining capacity]**

Displays the remaining capacity and total capacity of the SD memory card.

This is the same information that is displayed in [Remaining capacity] of the SD memory card information on the [SD memory card] tab of the “Basic” page.

### **[Total use time]**

Displays the length of time that SD memory card has been inserted into and used with the camera.

If the length of time that the SD memory card has been used for cannot be obtained, “Unknown” is displayed. “Total use time” is updated once per hour.

### **[Number of overwrite times]**

Displays the number of overwrite times as calculated from the total capacity of the SD memory card, the number of times the camera has written files to the SD memory card, and the file sizes.

If the number of overwrite times cannot be calculated, “Unknown” is displayed.

### **Note**

- Because the overwrite time values are just estimates calculated by the camera, they may differ to the actual number of overwrite times.

## [No.] / [Time & date] / [Description] of the log

Displays the log related to the SD memory card.

Category	Indication	Description
SD memory card	<SD> Format	Successfully formatted the SD memory card.
	<SD> Format error	Error occurred when formatting the SD memory card.
	<SD> Detection error	The SD memory card could not be correctly recognized.
	<SD> Write error	An error occurred when writing to the SD memory card.
	<SD> Read error	An error occurred when reading from the SD memory card.
	<SD> Delete error	An error occurred when deleting data from the SD memory card.
	<SD> File system error	An error occurred in File system of the SD memory card.
	<SD> Undefined error	An error other than the ones above has occurred for the SD memory card.

### IMPORTANT

- In order to be able to correctly use this function, format the SD memory card with the camera before using it.
- When using SD memory cards that have been used on other devices such as PCs, the correct information may not be able to be displayed.
- Up to 30 SD memory card logs can be saved to the built-in memory of the camera. When the saved system logs have reached the maximum number, the newer logs will overwrite the older system logs.

### Note

- Refer to our website ([https://i-pro.com/global/en/surveillance/training\\_support/support/technical\\_information](https://i-pro.com/global/en/surveillance/training_support/support/technical_information)) for further information about the contents of the displayed statuses (relating to the “Viewnetcam.com” service, the UPnP function, or the self check).

## 2.10.4 Reset the settings/Reboot the camera [Default reset]

Click the [Default reset] tab of the “Maintenance” page. (→For menu display and how to operate, refer to “2.2.1 How to display the setup menu”, “2.2.2 How to operate the setup menu”)

The settings of the camera can be initialized and reboot of the camera can be performed on this page.

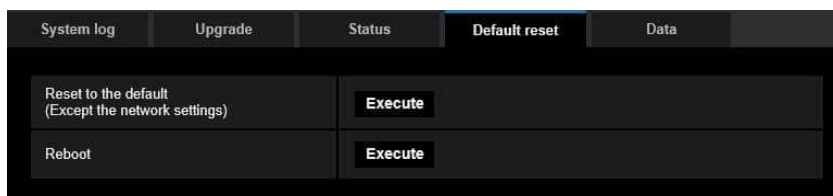

### [Reset to the default (Except the network settings)]

Click the [Execute] button to reset the settings to the default. Note that the network settings will not be reset. It is impossible to operate the camera for about 2 minutes after the initialization.

### [Reboot]

Click the [Execute] button to reboot the camera. It is impossible to operate the camera for about 2 minutes after rebooting the camera.

### Note

- Refer to the supplied “Installation Guide” for more information about initializing the network settings (→“2.8.1 Configure the network settings [Network]”).
- If “Diag.” of the alarm or e-mail notification function is selected, a notification of error will be sent to “Destination E-mail address” or to “Destination of notification” when an error such as no SD memory card insertion after the reboot occurs. (→“2.8.2.1 Configure the settings related to sending E-mails”, “2.6.7 Configuration of the settings relating to alarm notification [Notification]”)

## 2.10.5 Settings data/backing up or restoring logs [Data]

Click the [Data] tab of the “Maintenance” page. (→For menu display and how to operate, refer to “2.2.1 How to display the setup menu”, “2.2.2 How to operate the setup menu”)

The settings related to backing up or restoring settings data, and saving logs can be configured in this section.

The screenshot shows a web interface with a dark theme. At the top, there are five tabs: 'System log', 'Upgrade', 'Status', 'Default reset', and 'Data'. The 'Data' tab is selected. Below the tabs, there are two main sections: 'Backup' and 'Restore'.  
In the 'Backup' section, there are three rows, each with a label on the left and an 'Execute' button on the right:  
- 'Setup data' with an 'Execute' button.  
- 'Scene file' with an 'Execute' button.  
- 'Logs' with an 'Execute' button.  
In the 'Restore' section, there are two rows, each with a label on the left, a file selection area, and an 'Execute' button on the right:  
- 'Setup data': The file selection area contains a text input field and a 'Browse...' button. Below it are two radio button options: 'Restore all settings.' (which is selected) and 'Restore all settings except the network settings.'. An 'Execute' button is to the right.  
- 'Scene file': The file selection area contains a text input field and a 'Browse...' button. An 'Execute' button is to the right.  
At the bottom of the interface, there is a grey box with the text: 'It will take around 3 minutes to complete restoring data. Please wait and do not operate the browser during this process.'

## Backup

### [Setup data]

Click the [Execute] button to backup the setup data of the camera to a PC.

### [Scene file]

Click the [Execute] button to backup the scene files of the camera to a PC.

### [Logs]

Click the [Execute] button to backup the log data of the camera to a PC.

## IMPORTANT

- When backing up settings or logs, creating the backup files takes time.
- When the backup operation takes 10 minutes or more, a communication timeout may occur. In this case all of the backup data may not be obtained. Therefore, we recommend completing backup

operations within 10 minutes. It is also possible to check whether or not the correct data was obtained by restoring the obtained data (excluding log data).

## Restore

### [Setup data]

Press the [Browse...] button and select the setup data files to restore.

Click the radio button respective to the desired option to determine whether or not to also restore network related setting contents.

Click the [Execute] button to start restoring. Do not perform operations until the restoration is complete. (The camera will be rebooted when the restoration is complete.)

Make sure to set the file name of setup data files used when restoring to "model name.dat". (The model name must be written in lower case letters and "WV-" is not needed.)

**Default:** Restore all settings except the network settings.

### **IMPORTANT**

- When 5 minutes or more is required to restore setup data files, there is a possibility that the restore will fail because of reasons such as transmission disconnections. In this case, restore setup data files again.

### **Note**

- Restore operations for setup data are not applied to HTTPS related settings.

### [Scene file]

Press the [Browse...] button and select the scene files to restore.

Click the [Execute] button to start restoring. Do not perform operations until the restoration is complete.

Make sure to set the file name of scene file data used when restoring to "model name.txt". (The model name must be written in lower case letters and "WV-" is not needed.)

## 2.11 Display our support website [Support]

Methods for accessing our support website are explained on the "Support" page.

To access our support website from a web browser, click the link for the support page.

When "Click here for OSS information." is clicked, the license of the OSS in use will be displayed.

## 3 Others

### 3.1 About the displayed system log

#### Error indications relating to SMTP

Category	Indication	Description
POP3 server error	Authentication error.	<ul style="list-style-type: none"> <li>Entered user name or password may be incorrect. Check if the E-mail settings are configured correctly.</li> </ul>
	Failed to find the POP3 server.	<ul style="list-style-type: none"> <li>The IP address of the server may be incorrect. Check if the IP address of the server is configured correctly.</li> <li>The POP3 server may be down. Ask the network administrator.</li> </ul>
SMTP server error	Authentication error.	<ul style="list-style-type: none"> <li>Entered user name or password may be incorrect. Check if the E-mail settings are configured correctly.</li> </ul>
	Failed to resolve the E-mail server address from DNS.	<ul style="list-style-type: none"> <li>The designated IP address of the DNS may be incorrect. Check if the DNS settings are configured correctly.</li> <li>The DNS server may be down. Ask the network administrator.</li> </ul>
	Failed to find the SMTP server.	<ul style="list-style-type: none"> <li>The IP address of the server may be incorrect. Check if the IP address of the server is configured correctly.</li> <li>The SMTP server may be down. Ask the network administrator.</li> </ul>
Internal error	Undefined error.	<ul style="list-style-type: none"> <li>An error occurred in the E-mail function. Check if the E-mail settings are configured correctly.</li> </ul>

#### Error indications relating to “Viewnetcam.com”

Category	Indication	Description
Access test error	Access test failed	<ul style="list-style-type: none"> <li>Port forwarding may not be configured for the router. Refer to the manuals provided with the router in use to enable the UPnP setting.</li> </ul>
Viewnetcam.com server error	Failed to resolve the Viewnetcam.com server address from DNS.	<ul style="list-style-type: none"> <li>The designated IP address of the DNS may be incorrect. Check if the DNS settings are configured correctly.</li> <li>The DNS server may be down. Ask the network administrator.</li> </ul>

Category	Indication	Description
Connection error	No response from the Viewnetcam.com server.	<ul style="list-style-type: none"> <li>The “Viewnetcam.com” server may be down. Ask the network administrator.</li> </ul>
	File transfer error.	
Internal error	Undefined error.	<ul style="list-style-type: none"> <li>An error relating to the “Viewnetcam.com” function occurred. Check if the “Viewnetcam.com” settings are configured correctly.</li> </ul>

### Error indications relating to Dynamic DNS Update

Category	Indication	Description
DDNS server error	Failed to resolve the DDNS server address from DNS.	<ul style="list-style-type: none"> <li>The designated IP address of the DNS may be incorrect. Check if the DNS settings are configured correctly.</li> <li>The DNS server may be down. Ask the network administrator.</li> </ul>
Connection error	No response from the DDNS server.	<ul style="list-style-type: none"> <li>The DDNS server may be down. Ask the network administrator.</li> </ul>
	Same host name has registered.	<ul style="list-style-type: none"> <li>The same host name has already been registered in the DDNS server. Check if the DDNS Update settings are configured correctly.</li> </ul>
Internal error	Undefined error.	<ul style="list-style-type: none"> <li>An error occurred in the DDNS function. Check if the DDNS Update settings are configured correctly.</li> </ul>

### Error indications relating to NTP

Category	Indication	Description
Connection error	No response from the NTP server.	<ul style="list-style-type: none"> <li>The IP address of the server may be incorrect. Check if the IP address of the server is configured correctly.</li> <li>The NTP server may be down. Ask the network administrator.</li> </ul>
Internal error	Undefined error.	<ul style="list-style-type: none"> <li>An error occurred in the NTP function. Check if the NTP settings are configured correctly.</li> </ul>
Synchronizing with NTP succeeded.	NTP update succeeded.	<ul style="list-style-type: none"> <li>Time correction succeeded.</li> </ul>

## Log indications relating to HTTPS

Category	Indication	Description
HTTPS	Certificate Signing Request - Generated	<ul style="list-style-type: none"> <li>Generation of the CSR (Certificate Signing Request) is complete.</li> </ul>
	CA Certificate - Installed	<ul style="list-style-type: none"> <li>Installation of the CA certificate is complete.</li> </ul>
	CA Certificate - Deleted	<ul style="list-style-type: none"> <li>Deletion of the CA certificate is complete.</li> </ul>
	Previous CRT key - Applied	<ul style="list-style-type: none"> <li>Previous CRT key is applied.</li> </ul>
	CRT key - Generated	<ul style="list-style-type: none"> <li>Generation of the CRT key is complete.</li> </ul>

## Log indications relating to login

Category	Indication	Description
Login	User name or IP address	<ul style="list-style-type: none"> <li>The login user name will be displayed when "On" is selected for "User auth."</li> <li>The IP address of the PC currently accessing to the camera will be displayed when "On" is selected for "Host auth."</li> </ul>

## Error indications relating to login errors

Category	Indication	Description
Login failure	User name	<ul style="list-style-type: none"> <li>The user name of the user who failed to log in will be displayed when "On" is selected for "User auth."</li> <li>If the user is not registered, (Guest User) is displayed.</li> <li>Under normal operations, the "Login failure" log may be kept. This is not a problem with the camera.</li> <li>If there are many logs in succession, it may indicate that someone is trying to illegally access the camera. Consult with your network administrator.</li> </ul>

## Error indications relating to TCP alarm notification

Category	Indication	Description
TCP alarm notification error	Failed to find destination of notification.	<ul style="list-style-type: none"> <li>The IP address of the destination of notification may be incorrect. Check if the IP address of the destination of notification is configured correctly.</li> <li>The destination of notification may be down. Ask the network administrator.</li> </ul>
	Failed to resolve destination addr. from DNS.	<ul style="list-style-type: none"> <li>The DNS server settings may be incorrect. Check if the DNS settings are configured correctly.</li> <li>The DNS server may be down. Ask the network administrator.</li> </ul>

## Error indications relating to HTTP alarm notification

Category	Indication	Description
HTTP alarm notification error	Failed to find destination of notification.	<ul style="list-style-type: none"> <li>The IP address of the destination of notification may be incorrect. Check if the IP address of the destination of notification is configured correctly.</li> <li>The destination of notification may be down. Ask the network administrator.</li> </ul>
	Failed to resolve destination addr. from DNS.	<ul style="list-style-type: none"> <li>The DNS server settings may be incorrect. Check if the DNS settings are configured correctly.</li> <li>The DNS server may be down. Ask the network administrator.</li> </ul>
HTTP alarm notification	Authentication error.	<ul style="list-style-type: none"> <li>Entered user name or password may be incorrect. Check if the HTTP alarm notification settings are configured correctly.</li> </ul>

## 3.2 Troubleshooting

**Before asking for repairs, check the symptoms with the following table.**

Contact your dealer if a problem cannot be solved even after checking and trying the solution in the table or a problem is not described below.

Symptom	Cause/solution	Reference pages
Cannot access from the web browser.	<ul style="list-style-type: none"> <li>Is the LAN cable (category 5e or better) firmly connected to the network connector of the camera?</li> </ul>	Installation Guide
	<ul style="list-style-type: none"> <li>Is the link indicator (LINK) lit? When it is not lit, connection to a LAN may not be established or a network may not be working correctly. Check if the cables have any contact failure or if the wiring is correct or not.</li> </ul>	Installation Guide
	<ul style="list-style-type: none"> <li>Is the power of the camera on? Check if the power of the camera is turned on.</li> </ul>	Installation Guide
	<ul style="list-style-type: none"> <li>Are the set IP addresses valid?</li> </ul>	125
	<ul style="list-style-type: none"> <li>Are you accessing the wrong IP address? Check the connection as follows. With the Windows command prompt, &gt; ping "IP address of the camera". If there is reply from the camera, the connection is normal. If there is no reply, check the connection with the following methods using a computer connected to the same network as the camera. If the firewall settings on the PC are enabled, temporarily disable them before performing settings on the camera.                             <ul style="list-style-type: none"> <li>Start the "IP Setting Software", confirm the camera's IP address, and then access that IP address.</li> <li>If the network settings (IP address, subnet mask, and default gateway) are incorrect, reboot the camera and change the network settings by using the "IP Setting Software" within 20 minutes after the restart.</li> <li>In networks that do not have a DHCP server, the IP address of the camera will be configured to "192.168.0.10" when the camera is rebooted by holding the INITIAL SET button on the camera. After the camera is initialized, access the camera and set the IP address again. (When the camera is initialized, all the settings of the camera previously configured on the setup menu will be initialized.)</li> </ul> </li> </ul>	-

Symptom	Cause/solution	Reference pages
	<ul style="list-style-type: none"> <li>Is “554” selected for the HTTP port number? For the HTTP port number, select a port number other than the following port numbers used by the camera. The number used by the camera: 20, 21, 23, 25, 42, 53, 67, 68, 69, 110, 123, 161, 162, 443, 554, 995, 10669, 10670, 59000 - 61000</li> </ul>	128
	<ul style="list-style-type: none"> <li>Is the same IP address provided to other devices? Are there contradictions between the address and the network subnet to be accessed? <b>When the camera and the PC are connected in the same subnet:</b> Are the IP addresses of the camera and the PC set in a common subnet? Or is “Use Proxy Server” for the settings of the web browser checked? When accessing the camera in the same subnet, it is recommended to enter the address of the camera in the “Don’t Use Proxy For These Addresses” box. <b>When the camera and the PC are connected in the different subnet:</b> Is the IP address of the default gateway set for the camera correct?</li> </ul>	-
	<ul style="list-style-type: none"> <li>Is the name currently used to access the camera different from the name registered for the “Viewnetcam.com” service? Access the camera again with the registered name.</li> </ul>	164
	<ul style="list-style-type: none"> <li>Did you access “http://” while using the HTTPS function? To use the HTTPS function, access “https://”. It is also necessary to enter the port number.</li> </ul>	156 161
Cannot access the camera via the Internet.	<ul style="list-style-type: none"> <li>Are the network settings of the camera correct? Set the default gateway or DNS server address correctly. To use the DDNS service, check that the settings are correct.</li> <li>Is the setting for “Default gateway” on the “Network” page configured? Or is the setting correct? <b>When communicating using IPv4:</b> Configure the setting for “Default gateway” of “IPv4 network” on the [Network] tab of the setup menu.</li> </ul>	125

Symptom	Cause/solution	Reference pages
	<ul style="list-style-type: none"> <li>• Is the setting of port forwarding configured for the router? To enable the access to the camera via the Internet, it is necessary to perform the port forwarding setting when the router in use does not support the UPnP function. Refer to the manuals provided with the router for further information.</li> <li>• Is UPnP function of the router disabled? Refer to the manuals provided with the router in use to enable the UPnP function.</li> <li>• Is packet filtering set for the router to forbid the access via the Internet? Configure the settings of the router in use to enable the access via the Internet. Refer to the manuals provided with the router for further information about the settings.</li> </ul>	136
	<ul style="list-style-type: none"> <li>• Are you accessing the camera using the local address (the IP address used in a local network)? When accessing the camera, use the global address (or the URL registered in the DDNS service) and the port number of the camera as the IP address to be used in the Internet.</li> </ul>	126 127 162
Cannot access the camera via the URL of the "Viewnetcam.com" service.	<ul style="list-style-type: none"> <li>• Is the global address of camera (or router) notified to the "Viewnetcam.com" service server? Log into the "My Account" page of "Viewnetcam.com" website (<a href="http://www.viewnetcam.com/">http://www.viewnetcam.com/</a>) to check the information of the registered camera. If the global address is not displayed for the IP address, access the camera, and register the user information for the "Viewnetcam.com" service on the [Advanced] tab on the "Network" page of the setup menu. In addition, check the "Status" of "Viewnetcam.com" (on the [Status] tab) and the system log (on the [System log] tab) of the "Maintenance" page of the setup menu.</li> </ul>	164 176
Authentication window is displayed repeatedly.	<ul style="list-style-type: none"> <li>• Is the user name and password changed? While accessing the camera, when changing the user name and password of another user logging into the camera on another web browser, the authentication window will be displayed each time the screen is changed or refreshed. Close the browser and access the camera again.</li> <li>• Have you changed the [Authentication] setting? When the [Authentication] setting has been changed, close the web browser, and then access the camera again.</li> </ul>	-

Symptom	Cause/solution	Reference pages
It takes time to display the screen.	<ul style="list-style-type: none"> <li>Are you accessing the camera in the HTTPS mode? In this mode, the refresh interval becomes slower due to decode procession.</li> </ul>	-
	<ul style="list-style-type: none"> <li>Are you accessing another camera in the same local network via a proxy server? Configure the web browser to not use the proxy server.</li> </ul>	-
	<ul style="list-style-type: none"> <li>Are two or more users browsing the camera images simultaneously? It may take time to display the screen or refresh interval may become slower when two or more users browse the camera images simultaneously.</li> </ul>	-
Cannot access the camera from a mobile terminal or a tablet device.	<p><b>For mobile terminals:</b></p> <ul style="list-style-type: none"> <li>Is the URL correct? Or is "/cam" missing at the end of the URL? Check if the URL is entered correctly. When accessing the camera from a mobile terminal, it is necessary to enter "/cam" at the end of the URL that is used for the camera access from a PC.</li> </ul> <p><b>For tablet devices:</b></p> <ul style="list-style-type: none"> <li>Is the URL correct? Check if the URL is entered correctly.</li> </ul>	17
	<ul style="list-style-type: none"> <li>Is the SSL encryption method different from that of the camera? Select "HTTP" (Do not select "HTTPS") for "HTTPS" - "Connection" on the "Network" page - the [Advanced] tab, and access the camera again.</li> </ul>	137
	<ul style="list-style-type: none"> <li>Did you access "http://" while using the HTTPS function? To use the HTTPS function, access "https://". It is also necessary to enter the port number.</li> </ul>	161
A cookie error was displayed when performing user registration for "Viewnetcam.com".	<ul style="list-style-type: none"> <li>Is the web browser configured to allow cookies? Configure the web browser to allow cookies. In Internet Explorer, from [Tools] select [Internet Options] and configure the cookies setting in the [Privacy] tab.</li> </ul>	-
User registration for the "Viewnetcam.com" service fails.	<ul style="list-style-type: none"> <li>Is the registered E-mail address correct? When an E-mail with the "Viewnetcam.com" website link is not received, the registered E-mail address may be incorrect. Visit the "Viewnetcam.com" website (<a href="http://www.viewnetcam.com/">http://www.viewnetcam.com/</a>) to register the correct E-mail address.</li> </ul>	-

Symptom	Cause/solution	Reference pages
No image is displayed.	<ul style="list-style-type: none"> <li>Is the viewer software installed on the PC? Install the viewer software on a PC.</li> </ul>	4
	<ul style="list-style-type: none"> <li>Is the mobile terminal or tablet device in use support the 320×240 or 640×480 resolution? Or is the image data size too big to display images on the mobile terminal or tablet device? Refer to the manuals provided with the mobile terminal or tablet device in use for the restrictions of image data sizes.</li> </ul>	-
	<ul style="list-style-type: none"> <li>When performing a recording of a stream with a high bit rate on the SD memory card, there may be cases where live image of the same stream cannot be displayed. When it is necessary to display the live images of the stream, improve by performing either of the following.                             <ul style="list-style-type: none"> <li>Lower the bit rate of the stream being recorded on the SD memory card.</li> <li>Monitor live images of other stream or JPEG live images.</li> </ul> </li> </ul>	70 13
No image is displayed. / Older images or logs are displayed.	<ul style="list-style-type: none"> <li>When [Every time I visit the webpage] is not selected for [Check for newer versions of stored pages:] in the [Temporary Internet Files] section, images sometimes may not be displayed on the “Live” page. In this case, do the following.                             <ol style="list-style-type: none"> <li>Select [Internet Options...] from [Tools] on the menu bar of Internet Explorer. The [Internet Options] window will be displayed.</li> <li>Click the [Settings] button in the [Browsing history] section on the [General] tab, and then select [Every time I visit the webpage] for [Check for newer versions of stored pages:] in the [Temporary Internet Files] tab on the [Website Data Settings] window.</li> </ol> </li> </ul>	-
The image is not being refreshed.	<ul style="list-style-type: none"> <li>Depending on the version of your browser, there might be difficulties refreshing the picture, etc.</li> </ul>	Basic Information
	<ul style="list-style-type: none"> <li>Depending on the traffic of the network or the concentration of access to the camera, there might be difficulties displaying the camera picture. Request the camera picture using the web browser such as by pressing the [F5] key, etc.</li> </ul>	-
No image is displayed (or too dark).	<ul style="list-style-type: none"> <li>Is the brightness setting set at an appropriate level? Click the [Normal] button of [Brightness].</li> </ul>	13
Images are displayed washed out.	<ul style="list-style-type: none"> <li>Is the brightness setting set at an appropriate level? Click the [Normal] button of [Brightness].</li> </ul>	13
Flicker appears on the screen.	<ul style="list-style-type: none"> <li>When flicker occurs frequently, select “Indoor scene” for “Light control mode”.</li> </ul>	78

Symptom	Cause/solution	Reference pages
Images cannot be saved on the SD memory card.	<ul style="list-style-type: none"> <li>Is the SD memory card inserted correctly? Check if the SD memory card is inserted correctly.</li> </ul>	Installation Guide
Failed to write/read data on the SD memory card.	<ul style="list-style-type: none"> <li>Is the SD memory card formatted? Format the SD memory card.</li> </ul>	62
	<ul style="list-style-type: none"> <li>Is “-----MB/-----MB” displayed on “Remaining capacity” of the [SD memory card] tab? Format the SD memory card.</li> </ul>	62
	<ul style="list-style-type: none"> <li>Is any recognition error received when the “Diag.” of “E-mail notification” or “TCP alarm notification” is used? Format the SD memory card.</li> </ul>	62 131 111
	<ul style="list-style-type: none"> <li>Isn't the SD memory card out of order? There are limited times to overwrite on an SD memory card. When frequently overwritten, it may be at the end of product life. It is recommended to replace the SD memory card.</li> </ul>	-
The alarm occurrence indication button and the SD recording status indicator on the “Live” page do not display the current status in real time.	<ul style="list-style-type: none"> <li>Is the viewer software installed on the PC? Confirm that the viewer software “Network Camera View 4S” is installed.</li> </ul>	4
	<ul style="list-style-type: none"> <li>Is “Real time” selected for “Alarm status update mode”?</li> </ul>	51
No image is displayed on the “Live” page.	<ul style="list-style-type: none"> <li>Press the [F5] key on the keyboard of the PC or click the [Live] button.</li> </ul>	13
Shortcut icon of the camera is not displayed on “Network” of the PC.	<ul style="list-style-type: none"> <li>Is the Windows component of UPnP added? Add the component to the PC in use.</li> </ul>	136
Cannot download the log list.	<ul style="list-style-type: none"> <li>Download of files using Internet Explorer may be disabled. Enable “File Download” in the “Security Settings” window ([Internet Options] - [Security]). After changing the settings, close the web browser, and then access the camera again.</li> </ul>	-
Images are not displayed or not refreshed smoothly.	<ul style="list-style-type: none"> <li>Delete temporary internet files as follows. <ol style="list-style-type: none"> <li>Select “Internet Options...” under “Tools” on the menu bar of Internet Explorer. The “Internet Options” window will be displayed.</li> <li>Click the [Delete] button of [Browsing history].</li> <li>Check only the “Temporary Internet files and website files” checkbox in [Delete browsing history], and click the [Delete] button.</li> </ol> </li> </ul>	-

### 3 Others

---

Symptom	Cause/solution	Reference pages
	<ul style="list-style-type: none"><li>The firewall function of the anti-virus software may be filtering the port of the camera. Exclude the port number of the camera from the list of the port numbers to be filtered by the anti-virus software.</li></ul>	-
No indicator lights.	<ul style="list-style-type: none"><li>Is "Off" selected for "Indicator" on the "Basic" page? Select "On" for "Indicator".</li></ul>	51
Failed to download recorded data from the image playing screen in the browser.	<ul style="list-style-type: none"><li>You may not be using Internet Explorer with administrator rights. After shutting down all of the open Internet Explorer windows and tabs, restart Internet Explorer by right-clicking the Internet Explorer icon in the Start menu and selecting "Run as Administrator".</li><li>In the "Name of the destination directory for downloaded images" settings, specify a directory that general users can write to.</li></ul>	64
When clicking the back button of the web browser, the screen is not displayed correctly.	<ul style="list-style-type: none"><li>Press the [F5] key on the keyboard to refresh the display.</li></ul>	-

## Information Bar

The “Information Bar” (①) expressed in the following symptom and solutions will be displayed just below the address bar only when there is information to communicate.



Depending on the OS installed on the PC, the following may occur. Follow the instructions below when the following has occurred. By performing the following solutions, other applications may not be affected.

Symptom	Cause/solution	Reference pages
The following message is displayed on the information bar. “Internet Explorer blocked a pop-up from ***.***.***.*** (IP address).”	<ul style="list-style-type: none"> <li>Select “Options for this site” → “Always allow”.</li> </ul>	-
The following message is displayed on the information bar. “This webpage wants to run the following add-on: `WebVideo Module' from `*** (our company name)`.”	<ul style="list-style-type: none"> <li>Select [Allow].</li> </ul>	-
The following message is displayed on the information bar. “This webpage wants to install the following add-on: `nwc4Ssetup.exe' from `*** (our company name)`.”	<ul style="list-style-type: none"> <li>Select [Install]. The “Security Warning” window will be displayed. Click the [Install] button on the displayed “Security Warning” window.</li> </ul>	-
An unnecessary status bar or scroll bar is displayed on the pop-up window.	<ul style="list-style-type: none"> <li>Click “Internet Options...” under “Tools” of the menu bar of Internet Explorer, and then click the [Security] tab. Click “Internet” in the “Select a Web content zone to specify its security settings.” section. Then, click the [Custom level...] button to open the “Security Settings” window. Under “Miscellaneous”, select “Enable” for “Allow script-initiated windows without size or position constraints”. Click the [OK] button. When the warning window is displayed, click the [Yes] button.</li> </ul>	-

### 3 Others

---

Symptom	Cause/solution	Reference pages
Images are not fit in the frames.	<ul style="list-style-type: none"><li>When “120 DPI” or higher is selected for “DPI setting”, they may not be displayed correctly. <b>When using Windows 10:</b> Right-click on the desktop, click “Display settings”, and then move the slider of “Change the size of text, apps, and other items” to “100% (Recommended)”. Select “Landscape” of “Orientation”. <b>When using Windows 8.1:</b> Right-click on the desktop, click “Screen resolution” → “Make text and other items larger or smaller”, and then move the slider of “Change the size of all items” to “Smaller” so that the screen becomes the recommended size.</li></ul>	-

i-PRO Co., Ltd.

<https://www.i-pro.com/>