



**MOBOTIX MX-DoorMaster**  
MX-Door2-INT  
includes 2 additional frames  
(concave, angular), cavity wall socket  
and mounting supply

## Security Door Opener with Access Code Storage



- Open door, doorbell off/on, change sound
- Door indicator (open, closed, locked)
- Status LEDs for signaling
- Backup power supply with rechargeable battery
- Connection for door opener, door sensor and door lock sensor

*Controls door openers via encrypted MxBus communication and provides a doorbell for indoor installation (includes backup power supply for bell features and door opener)*

## Standard Connection: MX-DoorMaster with IP Video Door Station, Door Opener and Door Sensors

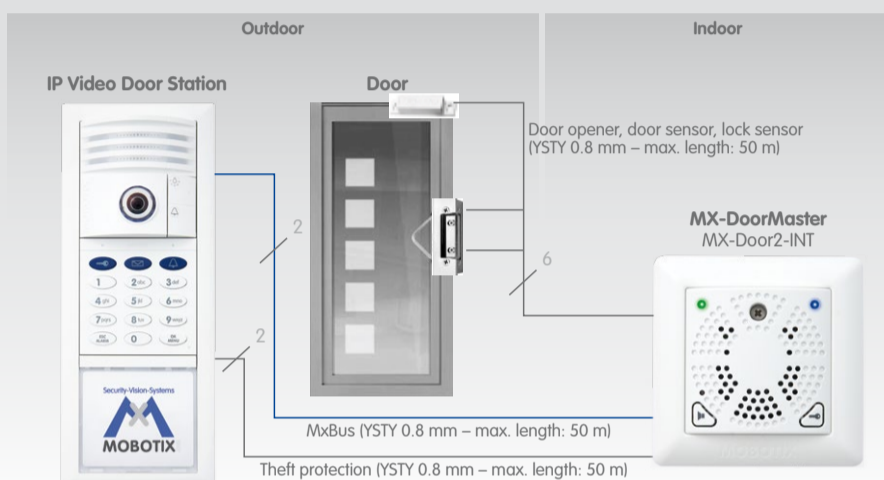

For additional information on the other connection variants and for installing, see the *IP Video Door Station System Manual Part 1* on [www.mobotix.com](http://www.mobotix.com) > Supprt > Manuals.



### Installing the MX-DoorMaster

Installing the module follows the procedure described in the *IP Video Door Station System Manual Part 1*, in *Section 2.5, "Installing the MX-DoorMaster"*. Please also refer to this section to get more information on connection variants (e.g. relay or Mediator operation).

### Charging the Battery Pack after Installing

Once you have installed the module, you need to charge the MX-DoorMaster's battery pack without interruption for at least 12 hours. The IP Video Door Station and its PoE power supply automatically charge the module via the MxBus two-wire connection. Note that you should not use the door opener MX-DoorMaster during this time (except for a short functional test). This ensures that you can extend the life cycle of the high-quality NiMH battery pack (heavy-duty industrial grade) to several years (given normal usage).

### Supported Door Openers

Standard door openers with 6 to 12 V AC (min. 16  $\Omega$  internal resistance) can be attached directly to the MX-DoorMaster; such a door opener is powered by the integrated battery pack. In this case, you do not need an additional power supply for the door opener. As an alternative, you can also connect door openers with up to 24 V AC/DC (max. 1 A) using an external power supply (relay operation) or a self-locking door lock ("Mediator"; see *IP Video Door Station System Manual Part 1, Section 2.5, "Installing the MX-DoorMaster"*).

### Replacing the Battery Pack

First, dismount the MX-DoorMaster (see the *IP Video Door Station System Manual Part 1, Section 2.4.6, "Removing and Exchanging Modules"*). Next, replace the battery pack and install the MX-DoorMaster again (see *Section 2.5.4, "Installation Using Cavity or In-Wall Socket"*).

### Replacing the MX-DoorMaster

If the MX-DoorMaster needs to be replaced against all expectations, you need a current backup of the system configuration. This will ensure that you can restore the encryption data later on. Please follow the steps outlined in the *IP Video Door Station System Manual Part 2* in *Section 5.2, "Backup & Restore"*. To dismount the MX-DoorMaster, follow the steps in the *IP Video Door Station System Manual Part 1* in *Section 2.4.6, "Removing and Exchanging Modules"*.

### HiRes Video Innovations

The German company MOBOTIX AG is known as the leading pioneer in network camera technology and its decentralized concept has made high-resolution video systems cost-efficient.

**MOBOTIX AG • D-67722 Langmeil • Tel: +49 6302 9816-103 • Fax: +49 6302 9816-190 • [sales@mobotix.com](mailto:sales@mobotix.com)**

## Operation: Keys and Signaling

MOBOTIX MX-DoorMaster  
MX-Door2-INT







Backup power supply of keypad and door opener upon power failure for up to 60 hours!



### General Signals

State	LED Left	LED Signal Left	LED Right	LED Signal Right
Door closed and locked	●	On	●	On
Door closed and not locked	●	On	●	Short flash 1x every 2 s
Door is open	●	On	○	Off
Doorbell is currently pressed	●	Short flash 1x every 0.5 s		
Missed doorbell	●	<5 min.: On, 1x/s briefly off >5 min.: On, 1x/2 s briefly off		
New mailbox message	●	Flash 1x every 2 s		





### User Actions

Action	Key	LED	LED Signal	Audio Notification
Open door	 Press for 3 s	R ●	Flashes 3x in 3 s, then twice	1 beep/s, then twice (acknowledge)
Doorbell off/on	 Press 1x	L ●	Short flash 1x every 5 s	1 beep (acknowledge)
Doorbell off/on (entire system)	 Press quickly 2x	L ●	Short flash 2x every 5 s	2 beeps (acknowledge)
Acknowledge message indicator	 Press briefly 1x			

### Adjust Volume

Action	Key	LED	LED Signal	Audio Notification
Start (stop after 5 s inactivity)	 Press for 2 s	L ●	Short flash 1x/s	1 beep, then twice (acknowledge)
Volume -	 Press 1x	L ●	Off	1 beep
Volume +	 Press 1x	R ●	Short flash 1x/s	1 beep

### Adjust Doorbell Sound

Action	Key(s)	LED	LED Signal	Audio Notification
Start (stop after 5 s inactivity)	 Press for 2 s	L ●	Short flash 1x/s	1 beep, then twice (acknowledge)
Switch	 +  Press briefly 1x	R ●	Short flash 2x/s	1 beep
Sound -	 Press 1x	L ●	Off	1 beep
Sound +	 Press 1x	R ●	Short flash 2x/s	1 beep

### Special/Error States

State	LED Left	LED Signal Left
Device error	●	On
Battery is empty	●	Flash with 3 s break
Power failure: Ready	●	Ultra-short flash with 4 s break

## Notes

- Please follow the notes on installing and operating the device in the *IP Video Door Station System Manual* ([www.mobotix.com](http://www.mobotix.com) in the **Support > Manuals** section). This manual also contains wiring diagrams for the different scenarios.
- This device is intended for indoor use only and must not be used outdoors.
- Make sure to properly dispose of the rechargeable battery in this device.
- Only replace the battery pack using MOBOTIX order no. MX-Door1-BAT!
- Maximum torque for the cover screw: 0.4 Nm.

## Dimensions



### HiRes Video Innovations

The German company MOBOTIX AG is known as the leading pioneer in network camera technology and its decentralized concept has made high-resolution video systems cost-efficient.

MOBOTIX AG • D-67722 Langmeil • Tel: +49 6302 9816-103 • Fax: +49 6302 9816-190 • sales@mobotix.com