



Surge Protection for MOBOTIX IP Cameras



- Protects MOBOTIX cameras against surges of up to 4 kV on the PoE network cabling
- For patch cable to patch cable or patch cable to installation cable (MX-Overvoltage-Protection-Box-LSA)
- Complete set including mounting supplies

Weatherproof network connector (IP65) with surge protection of up to 4 kV for MOBOTIX IP cameras; ideal for replacing MX-Patch-Box

31.684-006_EN_07/2015

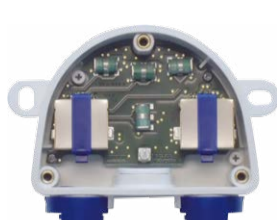

MX-Overvoltage-Protection-Box-RJ45:
MOBOTIX patch cable to MOBOTIX patch cable

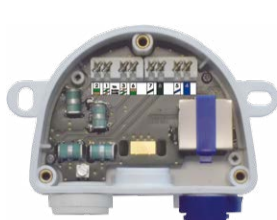

MX-Overvoltage-Protection-Box-LSA:
MOBOTIX patch cable to network installation cable

use IP
www.use-ip.co.uk
01304 827609

Surge Protection for MOBOTIX IP Cameras

Surges are voltages that exceed the allowed voltage range for MOBOTIX IP cameras. The max. voltage for PoE, for example, is 57 V. Surges do not necessarily result in irreparable damages to MOBOTIX IP cameras. Only if the voltage is exceeded by a multiple of the allowed value, or if the surge is present for a longer period of time or even permanently, damages are unavoidable.

Examples for Causes of Surges

- Direct lightning strike into the installation itself or the network cable
- Lightning strike into the power supply or the ground in the vicinity (within a radius of 100 km/62 mi)
- Switching of high loads, especially if network and power lines run side-by-side

Surge Protection

In order to reduce the danger of damages resulting from surges, a specialist should establish a surge protection concept and implement such a system. Such a system consists of several surge protection zones, where each zone contains specific and generally applicable countermeasures. These range from lightning capture devices and double-shielded network cables to fine-level surge protection for end devices. When selecting the countermeasures, not only technical, but also economical aspects need to be considered in order to find the proper balance between protection and costs.

The **MX-Overvoltage-Protection-Box-RJ45** and **MX-Overvoltage-Protection-Box-LSA** can be used in most of the protection zones and provide a cost-efficient protection against surges. It is generally recommended to install an MX-Overvoltage-Protection-Box if MOBOTIX cameras are installed outside of buildings. These devices protect MOBOTIX cameras against short surges of up to 4 kV.

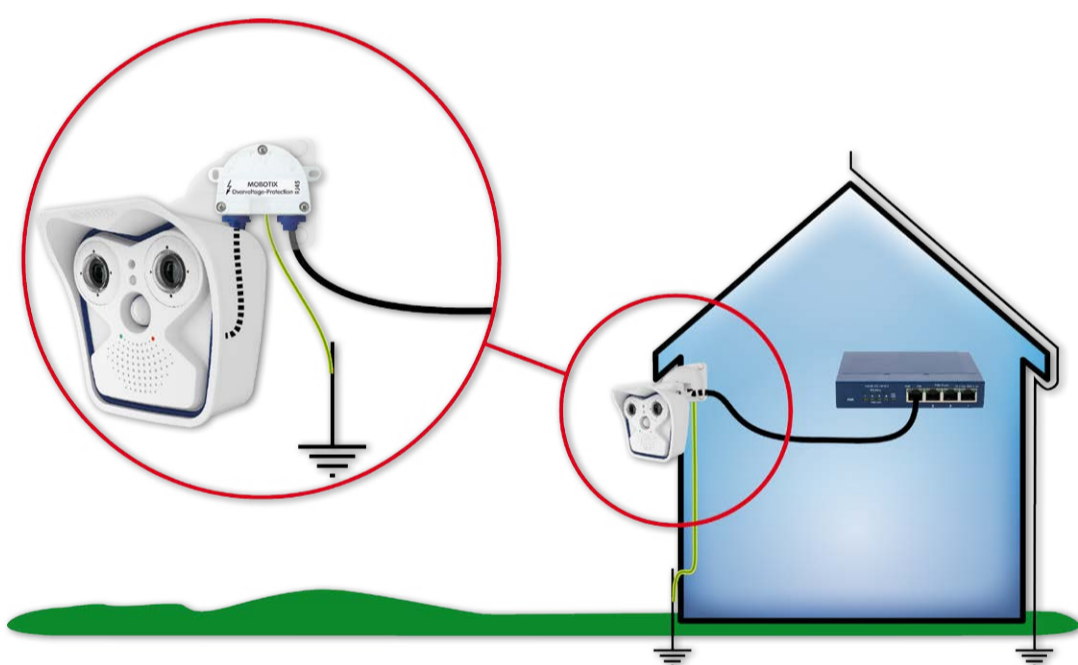

Caution

- The cable between the MX-Overvoltage-Protection-Box and the MOBOTIX camera must not be longer than 50 cm/19.7 in.
- An MX-Overvoltage-Protection-Box protects against surges of up to 4 kV on a network patch or installation cable, but not against direct lightning strikes.

MX-Overvoltage-Protection-Box-RJ45: Patch Cable/Patch Cable

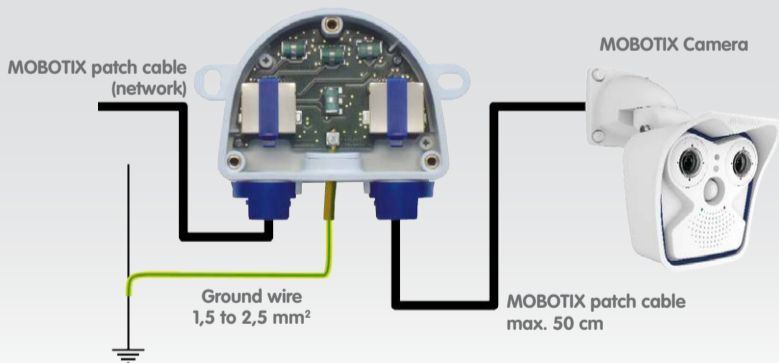

The patch cables with integrated sealing rings (available from MOBOTIX in different lengths) are simply inserted into the RJ45 connectors and fastened using the bayonet catch (1 patch cable to end device, 1 patch cable to PoE switch/injector). The ground wire is attached at the center (only qualified electricians are allowed to do this!).

MX-Overvoltage-Protection-Box-LSA: Patch Cable/Installation Cable

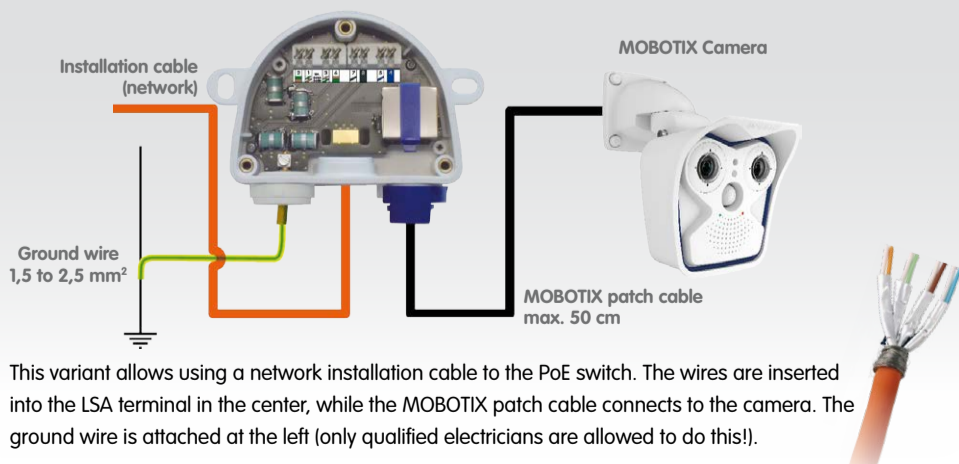

This variant allows using a network installation cable to the PoE switch. The wires are inserted into the LSA terminal in the center, while the MOBOTIX patch cable connects to the camera. The ground wire is attached at the left (only qualified electricians are allowed to do this!).

Innovations – Made in Germany

The German company MOBOTIX AG is known as the leading pioneer in network camera technology and its decentralized concept has made high-resolution video systems cost-efficient.

MOBOTIX AG • D-67722 Langmeil • Phone: +49 6302 9816-103 • Fax: +49 6302 9816-190 • sales@mobotix.com

Installing the MX-Overvoltage-Protection-Box-RJ45

1. Attach the box

Attach the MX-Overvoltage-Protection-Box-RJ45 at the mounting position with the cable ports pointing downwards and open the lid of the box (three screws).

2. Connect ground wire

Open the terminal screw (red circle in figure) using a regular screw driver. Strip the insulation of the supplied or existing ground wire for approx. 5 mm/0.2 in and push the wire through the eight-wire plug in the center. Insert wire into terminal and fasten terminal screw.

3. Attach the patch cable, close box

Remove both bayonet catches and the sealing plugs, insert MOBOTIX patch cables into the cable ports and secure them using the bayonet catches as shown. **Only use MOBOTIX patch cables with integrated sealing ring!** Mount the cover back onto the box (torque 0.4 Nm).

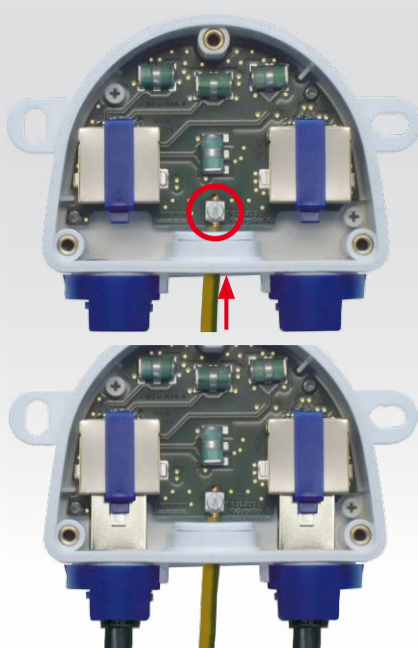

Installing the MX-Overvoltage-Protection-Box-LSA

1. Attach the box

Attach the MX-Overvoltage-Protection-Box-LSA at the mounting position with the cable ports pointing downwards and open the lid of the box (three screws).

2. Connect ground wire

Open the terminal screw (red circle in figure) using a regular screw driver. Strip the insulation of the supplied or existing ground wire for approx. 5 mm/0.2 in and push the wire through the eight-wire plug at the left. Insert wire into terminal and fasten terminal screw.

3. Prepare the installation cable

Cut the installation cable to size, push it through the cable plug 5 to 7 mm in the center, strip the cable for at least 35 mm and separate the individual wires of the cable into twisted pairs with 20 mm shielding. Wrap the shield mesh around the cable sheath 10 mm wide so that it can rest on the contact plate of the board. The cable will be fastened with a cable tie later on.

4. Feed the cable into the box

In order to prevent humidity entering the box, the rubber sleeve needs to be tight against the cable. Guide the supplied cable tie through the two cable slots as shown and pull the cable tie tight around the cable shield to provide proper strain relief.

5. Connect the cable wires

Use an LSA PLUS wire insertion tool to insert the individual wires into the LSA terminal. Decide on using either the EIA/TIA-568A or B wiring standard as in the rest of the building. The color code sticker in front of the LSA terminal shows both standards. If no LSA PLUS tool is available, you can use a tool with interchangeable blades (LSA/Krone blade with setting "Low Impact").

6. Attach the patch cable, close box

Remove right-hand bayonet catch and sealing plug, insert MOBOTIX patch cable into the cable port and secure it using the bayonet catch as shown. **Only use MOBOTIX patch cables with integrated sealing ring!** Mount the cover back onto the box (torque 0.4 Nm).

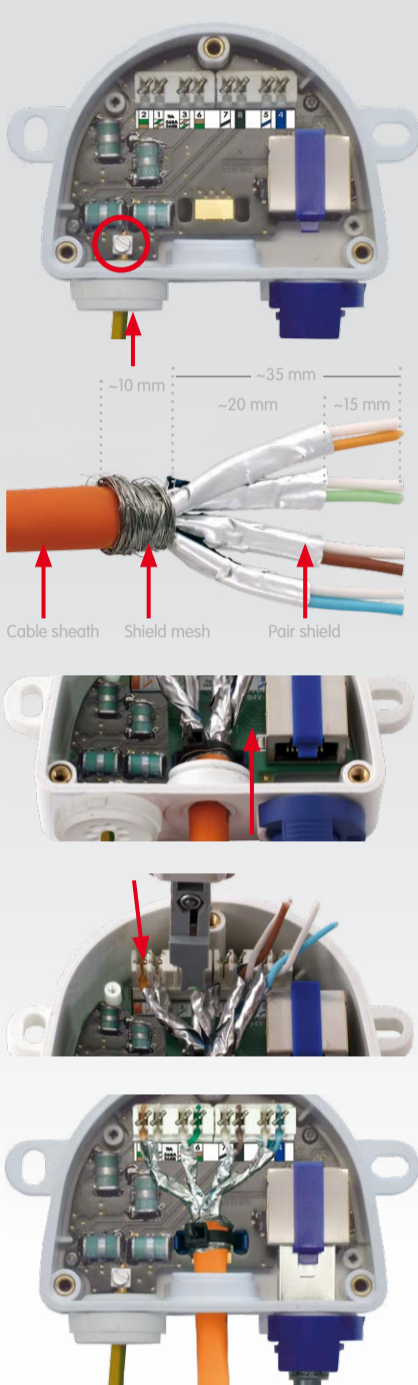

Technical Specifications	
Normal Usage	Surge protection for MOBOTIX cameras with PoE power supply (PoE+ according to IEEE 802.3at up to 57 V)
Protection Against Surges	Tested up to 4 kV on all wires of an attached cable according to test standard EN 61000-4-5
Protection class	IP65 (DIN EN 60529)
Operating temperature	-30 to +60 °C/-22 to 140 °F (DIN EN 50125)
Strength of the Ground Wire	1.5 to 2.5 mm ²

Important Notes

- The cable from the MOBOTIX device to this product must not be longer than 50 cm/19.7 in.
- When using an installation cable, pay attention to the correct twisting and shielding of the cable.
- Position of holes in combination with VarioFlex wall mount: see drilling template below.
- All unused ports must be closed with the supplied rubber seals.
- Maximum torque for all box cover screws: 0.4 Nm.
- The ground wire may only be connected by qualified electricians.
- This product must not be used in locations exposed to the dangers of explosion.
- It is only allowed to connect one MOBOTIX device to this product.
- Make sure that you are installing this product on a solid surface.
- Make sure that you are installing this product with the connectors pointing downwards.
- If the surcharge is higher than 4 kV, internal parts may get destroyed in order to prevent damage to the attached device. In this case, you will have to exchange the MX-Overvoltage-Protection-Box at your own cost; any warranty is excluded.

Drilling Template for VarioFlex Wall Mount with MX-Overvoltage-Protection-Box

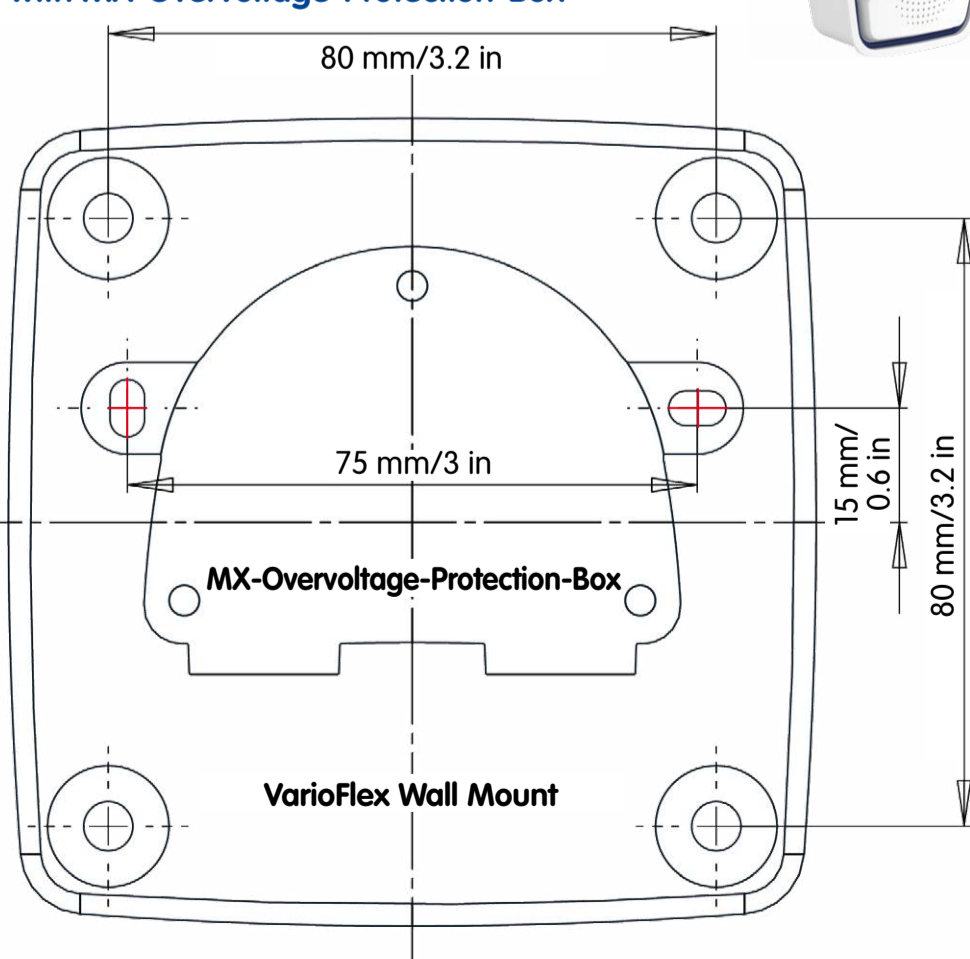

Innovations – Made in Germany

The German company MOBOTIX AG is known as the leading pioneer in network camera technology and its decentralized concept has made high-resolution video systems cost-efficient.

MOBOTIX AG • D-67722 Langmeil • Phone: +49 6302 9816-103 • Fax: +49 6302 9816-190 • sales@mobotix.com