

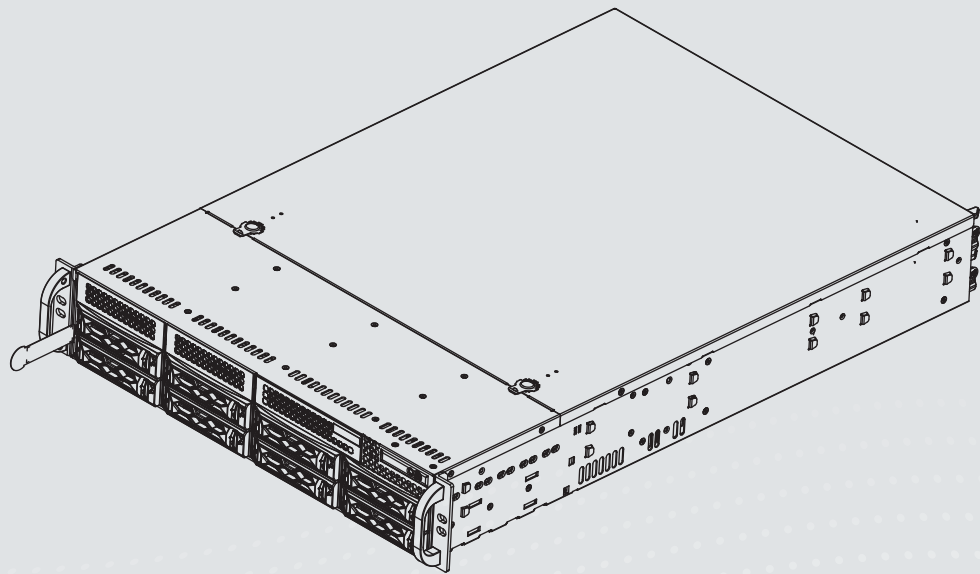

NR9581-v2
NR9681-v2 Network Video Recorder

User's Manual

Rack-mount Enclosure • 32-/64-channel Recording • 8x Hot-swappable H.D.D.
RAID storage • Full Integration with VIVOTEK Cameras



Rev. 1.0
for VAST rev. 2.9

Table of Contents

Revision History	4
Chapter One Hardware Installation and Initial Configuration	6
Introduction.....	6
Special Features	6
Safety	7
Installation Instructions	8
Power Supply	9
Environmental Specifications	9
Grounding Requirements	10
Physical Description	11
Drive Bay Numbering Sequence	11
Front View	11
Rear View	14
Display	15
Chassis Dimensions.....	16
Rack-mounting	17
Installing Hard Disk Drives	23
Connecting Interfaces	26
Initial Configuration.....	26
RAID Basics	44
Chapter Two VAST2 Software Configuration and Management	61
Log in.....	61
Introducing VAST2	62
Charged Add-on Features	64
Installation Option - OpenVPN	68
Chapter 2-1 Basics: Control and Elements	71
Hot Keys	89
View Cell Elements	92
VAST Server and Client Components	96
Minimum System Requirements	98
Chapter 2-2 Starting Up	100
2-2-1. Selecting Devices	101
2-2-2. Recording Options	102
Seamless Recording	106
Activity Adaptive Stream	107
Adding NAS (Network Attached Storage) as a Storage Option	108
2-2-3. Storage	112
2-2-4. Starting Up - Main Page.....	113
2-2-5. Saving a View	116
2-2-6. Add More Live Views	117
2-2-7. Save Your Preferences	118
2-2-8. Customizable Layout	119
2-2-9. Dashboard	121

2-2-10. E-Map	123
Placing DI/DO Devices	126
Configuring Google Map and GPS	127
2-2-11. Event Search.....	133
2-2-12. PTZ Control.....	136
2-2-13. Playback	138
2-2-14. Alarm	145
Group Alarm	154
2-2-15. Search Panel	158
2-2-16. Smart search.....	161
2-2-17. Tour	171
2-2-18. Thumbnail search	173
Chapter 3 Applications:	175
3-1. I/O DI/DO Devices: IO Box and Related Configuration.....	175
Configuring I/O Box DI/DO as a Trigger or Action in Alarm	177
3-2. Configuring Redundant Servers - Failover	181
Failover Configuration Process	188
3-3. VCA (Video Content Analysis)	192
3-4. VAST Software License.....	205
Updating Licenses for VAST on Virtual Machines	209
Reminders for VAST Software License	215
Chapter 4 Settings:	216
4-1. Settings > System > Preferences.....	216
4-2. Settings > Device > Cameras	222
Streaming URL.....	223
4-3. Logical Folders.....	225
4-4. Settings > Recording > Recording Options.....	228
4-5. Settings > Recording > Backup	230
Storage.....	233
4-6. Settings > Device > Sites	234
Multicasting	237
4-7. Settings > Device > POS	241
4-8. Settings > Device > Local DB	242
4-9. Settings > System > SMTP	246
4-10. Settings > IO Box and Related Configuration	246
4-11. Settings > User Management.....	247
Add a New User Account - Windows AD Account.....	249
Appendix A: VAST Service Control Tool	251
Appendix B: Matrix	252
Appendix C: Joystick Support	257
Appendix D: Upload Device Pack	263
Appendix E: Using LPR Related Functions w/ Data Magnet.....	265
Appendix F: Enable Smart Tracking for Speed Dome Cameras	282
Appendix G: Database Merge Function	284

Revision History

Rev. 1.0: Initial release. The description for the software functionality is based on VAST rev. 2.9.

WARNING:

1. Do not format or initialize the **Disk 0:** drive on your NVR. The **Disk 0:** drive contains the operating system. Doing so will disable the system.
2. No storage system is completely fail-safe. Damage to data might occur due to file system corruption, operating system malfunction, virus infection, HDD component failures, and so on. Therefore, it is highly recommended to regularly back up your data, and VIVOTEK disclaims responsibilities of data loss or recovery.
3. Always power off the system using the power down button on system desktop. Do not disconnect the power cord while the system is still operating. Doing so will result in data inconsistencies. The normal power-off procedure allows cached data to be written to disks.

IMPORTANT:

Some low quality Ethernet cables with smaller core diameter can seriously reduce the transmission rate. Use CAT5e or CAT6 cables with a wire gauge of 24AWG for NVR's uplink port. A thicker core 24 AWG network cable can offer less resistance than a 26 AWG or 28 AWG network cable.

Use shielded cables in high noise environments where cross talk and EMI can occur.

Technology License Notice



Notices from HEVC Advance:

THIS PRODUCT IS SOLD WITH A LIMITED LICENSE AND IS AUTHORIZED TO BE USED ONLY IN CONNECTION WITH HEVC CONTENT THAT MEETS EACH OF THE THREE FOLLOWING QUALIFICATIONS: (1) HEVC CONTENT ONLY FOR PERSONAL USE; (2) HEVC CONTENT THAT IS NOT OFFERED FOR SALE; AND (3) HEVC CONTENT THAT IS CREATED BY THE OWNER OF THE PRODUCT. THIS PRODUCT MAY NOT BE USED IN CONNECTION WITH HEVC ENCODED CONTENT CREATED BY A THIRD PARTY, WHICH THE USER HAS ORDERED OR PURCHASED FROM A THIRD PARTY, UNLESS THE USER IS SEPARATELY GRANTED RIGHTS TO USE THE PRODUCT WITH SUCH CONTENT BY A LICENSED SELLER OF THE CONTENT. YOUR USE OF THIS PRODUCT IN CONNECTION WITH HEVC ENCODED CONTENT IS DEEMED ACCEPTANCE OF THE LIMITED AUTHORITY TO USE AS NOTED ABOVE.

Read Before Use

The use of surveillance devices may be prohibited by law in your country. The Network Camera is not only a high-performance web-ready camera but can also be part of a flexible surveillance system. It is the user's responsibility to ensure that the operation of such devices is legal before installing this unit for its intended use.

It is important to first verify that all contents received are complete according to the Package Contents listed below. Take note of the warnings in the Quick Installation Guide before the Network Camera is installed; then carefully read and follow the instructions in the Installation chapter to avoid damage due to faulty assembly and installation. This also ensures the product is used properly as intended.

The Network Camera is a network device and its use should be straightforward for those who have basic networking knowledge. It is designed for various applications including video sharing, general security/surveillance, etc. The Configuration chapter suggests ways to best utilize the Network Camera and ensure proper operations. For creative and professional developers, the URL Commands of the Network Camera section serves as a helpful reference to customizing existing homepages or integrating with the current web server.

セキュリティ基準（新規則第 34 条の 10）

「本製品は 電気通信事業者（移动通信会社、固定通信会社、インターネットプロバイダ等）の通信回線（公衆無線 LAN を含む ）に直接接続することができません。本製品をインターネットに接続する場合は、必ずルータ等を経由し接続してください。」



NOTE:

The operating system and management software are installed on a flash memory mounted on the main board. Except for the plug-ins for onscreen display, there is no need to install software.

Symbols and Statements in this Document



INFORMATION: provides important messages or advices that might help prevent inconvenient or problem situations.



NOTE: Notices provide guidance or advices that are related to the functional integrity of the machine.



Tips: Tips are useful information that helps enhance or facilitate an installation, function, or process.



WARNING! or IMPORTANT: These statements indicate situations that can be dangerous or hazardous to the machine or you.



Electrical Hazard: This statement appears when high voltage electrical hazards might occur to an operator.

Chapter One Hardware Installation and Initial Configuration

Introduction

NR9581/9681-v2 is the latest 64- or 32-channel H.265, RAID-protected NVR from VIVOTEK, bringing stable and efficient system operation under a wide range of recording/network management/system settings. The unit supports all VIVOTEK camera models, including the latest 5-Megapixel and fisheye cameras. The support for RAID 1/5/6/10 provides data security in the event of disk drive failure.

The unit is equipped with two gigabit Ethernet RJ45 ports which provide network failover functionality to avoid the risk of recording loss. When one network line is disconnected, the system will shift to the other network automatically, providing continuous access for video data. Up to 8 HDDs can be installed in the NR9581/9681 for a total storage capacity of up to 48TB (6TB max. each). Eight removable HDD trays are available in the front of the unit, with hot-swap functionality for easy replacement.

A VAST2 CMS server runs on the machine that manages surveillance recording and playback. The compatibility with the iViewer application allows for remote access to the NR9581-v2/NR9681-v2 on handheld devices. By integrating all of the components together using VIVOTEK's NVR, network cameras, VAST2, and iViewer software, users can realize a fully-featured and robust next-generation surveillance system. This ingenious NVR also features the remote management capability with a full range of server/client structures and thus is capable for robust and diverse applications.

Special Features

- Runs on embedded Windows
- 2U Rack Mount Design
- RAID 0, 1, 5, 6, 10, 50, 60 in virtual drive storage configurations
- 8 x HDD Tray, for a max. capacity of 48TB
- 2 x Gigabit RJ45 Ethernet ports
- 6 x USB Port (2 x Front / 4 x in Back)
- Size: 17.2" (437 mm) (W) x 25.5" (647 mm) (D) x 3.5" (89 mm) (H)
- Gross Weight: 33 lbs (14.97 kg)
- 64-CH Live View & 16-CH Synchronous Playback
- H.265/H.264/ MPEG-4
- PTZ Support
- Snapshot / Export Media
- PiP Video Control
- Bookmark Design
- Fast Configuration Backup / Restore
- Pre-installed VIVOTEK VAST Central Management Software*
- Full Integration with VIVOTEK Network Cameras
- VIVOTEK iViewer Support (iOS/Android)

Safety

1. Read these safety instructions carefully.
2. Keep this User Manual for later reference.
3. Disconnect this equipment from any AC outlet before cleaning. Use a damp cloth. Do not use liquid or spray detergents for cleaning.
4. For plug-in equipment, the power outlet socket must be located near the equipment and must be easily accessible.
5. Keep this equipment away from humidity.
6. Put this equipment on a reliable surface during installation. Dropping it or letting it fall may cause damage.
7. For rack-mount equipment, please firmly install the device with pallets or sliding rails in the rack.
8. Do not leave this equipment in an environment unconditioned where the storage temperature under 0° C (32° F) or above 40° C (104° F), it may damage the equipment.
9. The openings on the enclosure are for air convection. Protect the equipment from overheating. **DO NOT COVER THE OPENINGS.**
10. Make sure the voltage of the power source is correct before connecting the equipment to the power outlet.
11. Position the power cord so that people cannot step on it. Do not place anything over the power cord.
12. All cautions and warnings on the equipment should be noted.
13. If the equipment is not used for a long time, disconnect it from the power source to avoid damage by transient overvoltage.
14. Never pour any liquid into an opening. This may cause fire or electrical shock.
15. Never open the equipment. For safety reasons, the equipment should be opened only by qualified service personnel.
16. If one of the following situations arises, get the equipment checked by service personnel:
 - The power cord or plug is damaged.
 - Liquid has penetrated into the equipment.
 - The equipment has been exposed to moisture.
 - The equipment does not work well, or you cannot get it to work according to the user's manual.
 - The equipment has been dropped and damaged.
 - The equipment has obvious signs of breakage.
17. **CAUTION:** The computer is provided with a battery-powered real-time clock circuit. There is a danger of explosion if battery is incorrectly replaced. Replace only with same or equivalent type recommended by the manufacturer. Discard used batteries according to the manufacturer's instructions.
18. This device complies with Part 15 of the FCC rules. Operation is subject to the following two conditions: (1) this device may not cause harmful interference, and (2) this device must accept any interference received, including interference that may cause undesired operation.

19. **CAUTION:** Always completely disconnect the power cord from your chassis whenever you work with the hardware. Do not make connections while the power is on. Sensitive electronic components can be damaged by sudden power surges.
20. **CAUTION:** Always ground yourself to remove any static charge before touching the motherboard, backplane, or add-on cards. Modern electronic devices are very sensitive to static electric charges. As a safety precaution, use a grounding wrist strap at all times. Place all electronic components on a static-dissipative surface or in a static-shielded bag when they are not in the chassis.
21. **CAUTION:** Any unverified component could cause unexpected damage. To ensure the correct installation, please always use the components (e.g., screws) provided with the accessory box.

Installation Instructions



Warning:

Read the installation instructions before connecting the system to the power source.



Warning:

This product relies on the building's installation for short-circuit (overcurrent) protection. Ensure that the protective device is rated not greater than: 250V, 20 A.



Warning:

The system must be disconnected from all sources of power and the power cord removed from the power supply module(s) before accessing the chassis interior to install or remove system components.



Warning:

Only trained and qualified personnel should be allowed to install, replace, or service this equipment.



Warning:

This unit is intended for installation in restricted access areas. A restricted access area can be accessed only through the use of a special tool, lock and key, or other means of security. (This warning does not apply to workstations).



Warning:

There is the danger of explosion if the battery is replaced incorrectly. Replace the battery only with the same or equivalent type recommended by the manufacturer. Dispose of used batteries according to the manufacturer's instructions.



Warning:

This unit might have more than one power supply connection. All connections must be removed to de-energize the unit.



Warning:

Hazardous voltage or energy is present on the backplane when the system is operating. Use caution when servicing.



Warning:

Installation of the equipment must comply with local and national electrical codes.



Warning:

Ultimate disposal of this product should be handled according to all national laws and regulations.



Warning:

The fans might still be turning when you remove the fan assembly from the chassis. Keep fingers, screwdrivers, and other objects away from the openings in the fan assembly's housing.



Warning:

When installing the product, use the provided or designated connection cables, power cables and AC adaptors. Using any other cables and adaptors could cause a malfunction or a fire. Electrical Appliance and Material Safety Law prohibits the use of UL or CSA -certified cables (that have UL/CSA shown on the code) for any other electrical devices than products designated by the manufacturer only.

Power Supply

Watt	600W max. (94+ Gold, PFC) (1+1 Redundant 2U)
Input rating	600W with Input 100 - 127Vac, 50-60Hz
Output voltage	+12 V: Max: 50A (100Vac - 127Vac); Max: 54.16A (200Vac - 240Vac); Max: 54.16A (200 - 240) @ 45A. +5Vsb: Max: 4A / Min: 0A
Power distributor	PDB-PT826-L8824 - O/P: 12V/75, +5V Max: 30, +3.3V Max: 24, -12V Max: 0.6
Safety	BSMI/CCC/CE/EMC/FCC

Environmental Specifications

Environment	Operating	Non-operating
Temperature	5 ~ 35°C (32 ~ 104°F)	-40 ~ 70°C (-40 ~ 158°F)
Humidity	8 ~ 90% @ 40°C, non-condensing	5 ~ 95% @ 60°C, non-condensing

Grounding Requirements

1. The enclosure is designed to be rack-mounted, in an equipment room which has limited human access.
2. In addition to the grounding via the power cords, make sure your equipment rack is properly grounded.
3. Use a ground wire of a copper cross section of at least 16AWG.

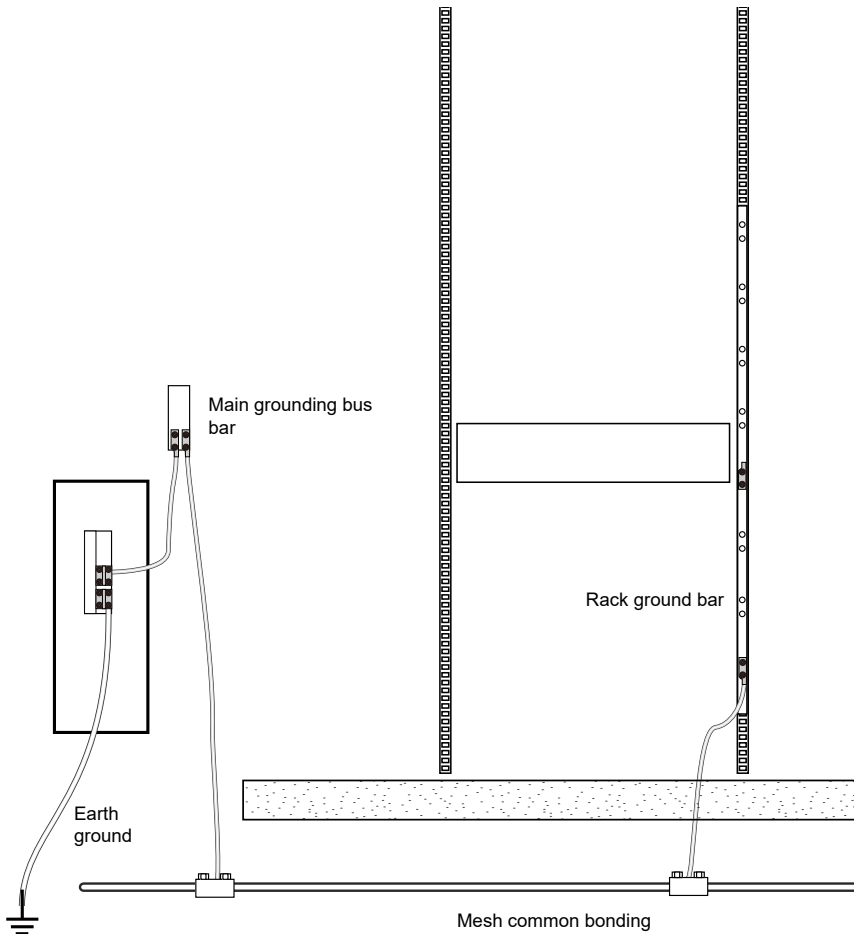

Physical Description

● Front View

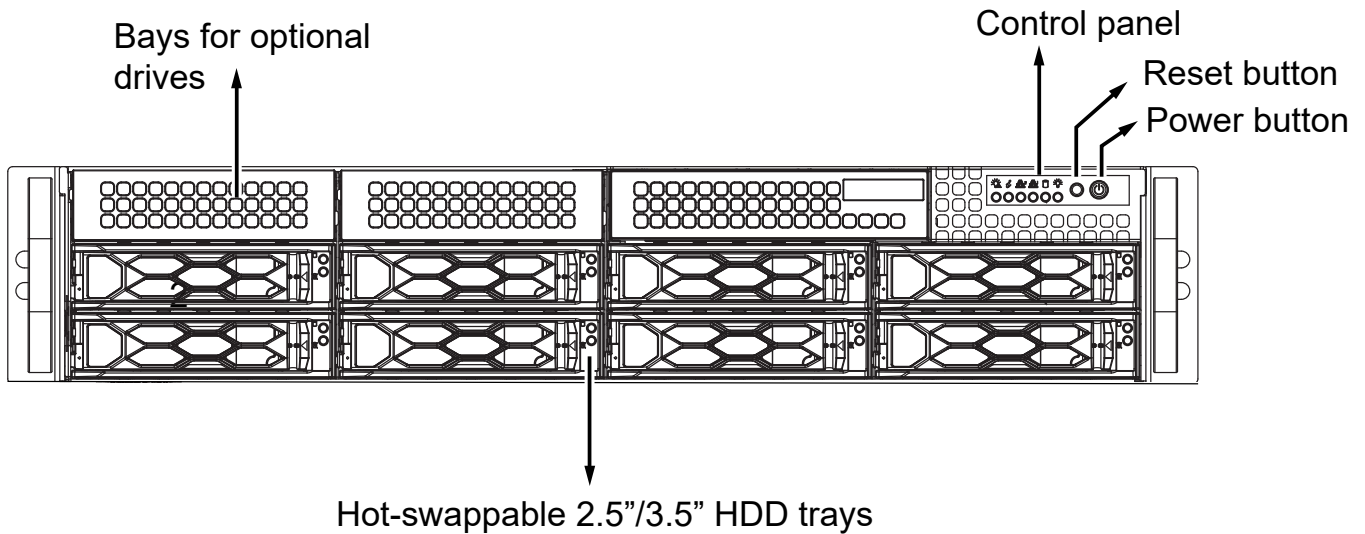

Drive Bay Numbering Sequence

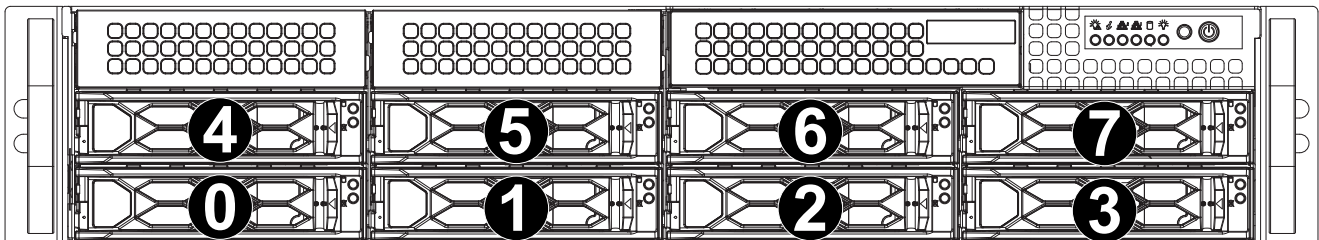

Warning:

Knowing the correct positions of hard drives is very important. For example, if a hard drive fails in a RAID5 Virtual Drive, you can initialize a rebuild by locating and replacing the failed drive. If you replace the wrong drive, it means that you have 1 failed drive and another mistakenly failed drive. Having 2 failed drives in a RAID5 configuration renders all data inaccessible. All data in the RAID5 Virtual Drive will be lost.

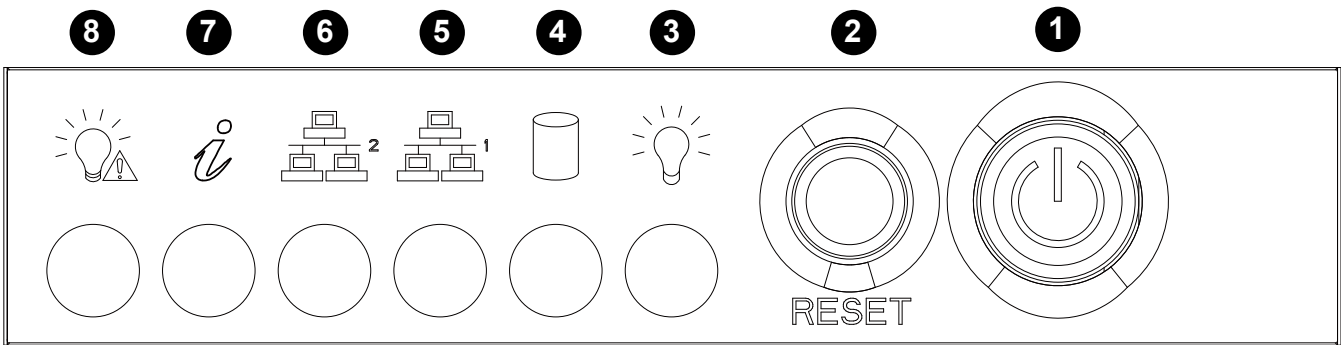

Control Panel buttons and LEDs		
1	Power switch	Press this switch to turn the system power on or off. Please use system shutdown or press this switch for a few seconds to turn off the system ATX power. The main power switch is used to apply or remove power from the power supplies to the server. Turning off system power using this button removes the main power but keeps standby power supplied to the system. You must unplug the system before servicing components inside the chassis.
2	Reset button	Press this button to reboot the system.
3	Power LED	Indicates power is being supplied to the system power supply units. This LED is illuminated when the system is operating normally.
4	HDD LED	Indicates hard disk drive activities
5	LAN status LED	Indicates network activity on LAN1 when flashing.
6	LAN status LED	Indicates network activity on LAN2 when flashing.
7	Information LED*	Alerts operator to several states, as noted in the table below.
8	Power failed LED	Indicates a power supply module has failed.

* The HDD LED here only displays the status for those attached to the motherboard. They do not display the status for the hard disks in the 16 drive bays

Information LED	
Continuously on and red	An overheat condition has occurred. (This may be caused by cable congestion.)
Blinking red (1Hz)	Fan failure, check for an inoperative fan.
Blinking red (0.25Hz)	Power failure, check for a non-operational power supply.
Solid blue	UID has been activated locally to locate the server in a rack environment.
Blinking blue	UID has been activated using IPMI to locate the server in a rack environment.

Each drive carrier has two LED indicators: an activity indicator and a status indicator. For RAID configurations using a controller, the meaning of the status indicator is described in the table below. For OS RAID or non-RAID configurations, some LED indications are not supported, such as hot spare.

Drive Tray LED Definitions			
	Color	Blinking pattern	Device Behavior
Activity LED	Blue	Solid ON	SAS drive installed
		Blinking	I/O activity
Status LED	Red	Solid ON	Failure of drive with RSTe support
		Blinking at 1 Hz	Rebuild drive with RSTe support
		Blinking with two blinks and one stop at 1 Hz	Hot spare for drive with RSTe support (not supported in VMD mode)
		On for five seconds, then off	Power on for drive with RSTe support
		Blinking at 4 Hz	Identify drive with RSTe support

Rear View

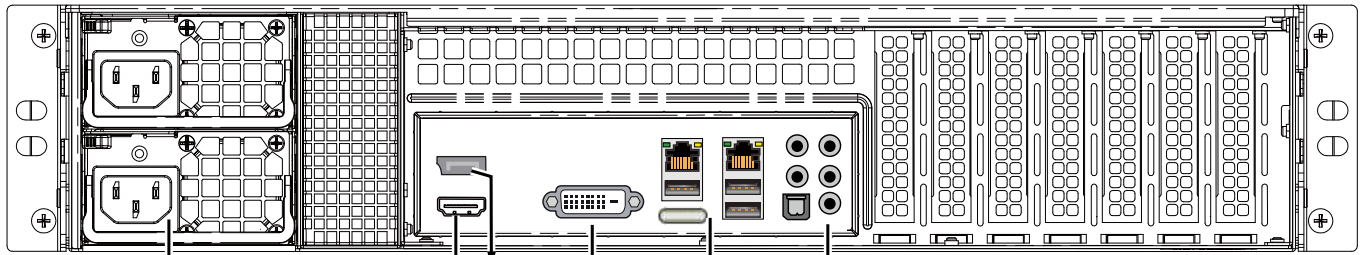

Redundant power supplies

Display port
HDMI

DVI-D LAN & USB ports

Audio In/Out

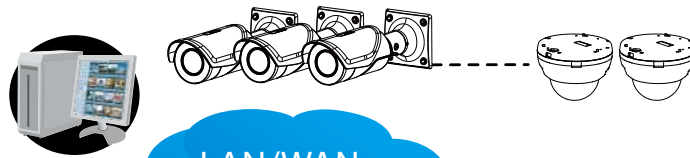

LAN1

LAN2

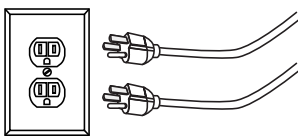
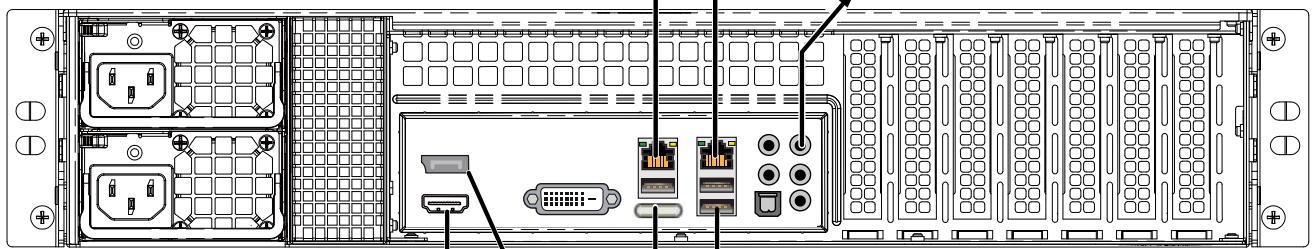

AC100~240V
50/60Hz, 600W



Display

Interface	Resolution
HDMI	Supports max resolution HDMI 1.2 1920 x 1200 @ 60 Hz
DVI-D	Currently not supported. Supports max. resolution 1920 x 1200 @ 60 Hz
Display port	Supports max resolution 4096 x 2304 @ 60 Hz
eDP	Internal pin header, supports max. resolution 3840 x 2160 @ 60 Hz (on board)

IMPORTANT:

It is important to leave a clearance of 76cm to the rear side of the chassis. The clearance is required to ensure an adequate airflow through the chassis to ventilate heat. A 64cm clearance is also required on the front of the chassis.

To ensure normal operation, maintain ambient airflow. Do not block the airflow around chassis such as placing the system in a closed cabinet.

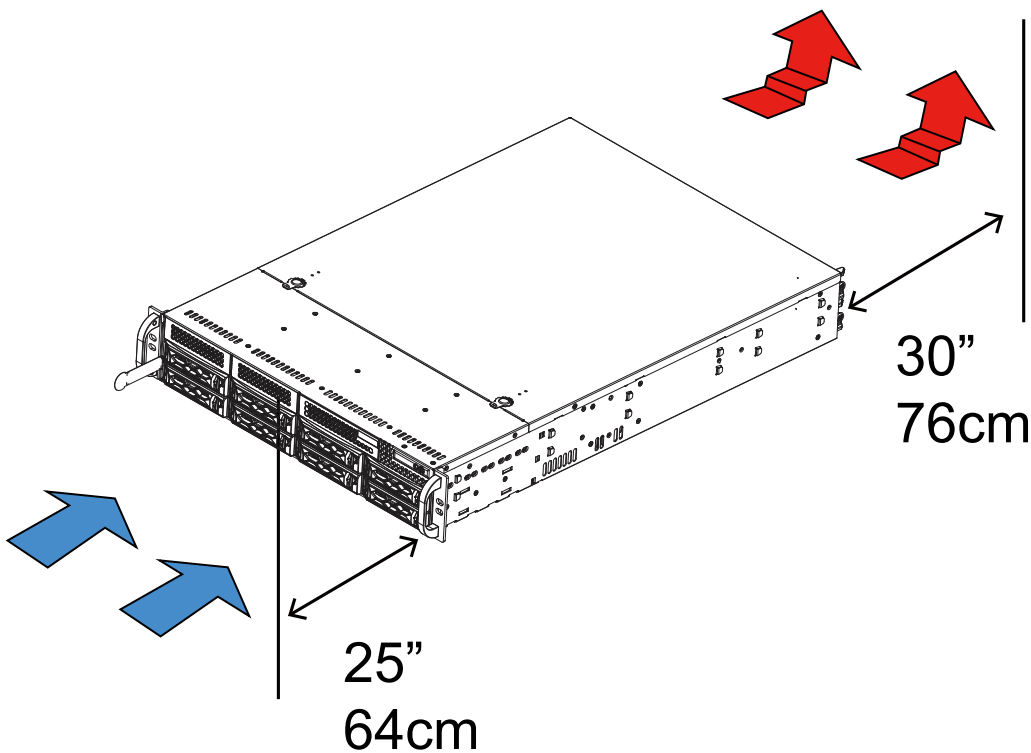

Chassis Dimensions

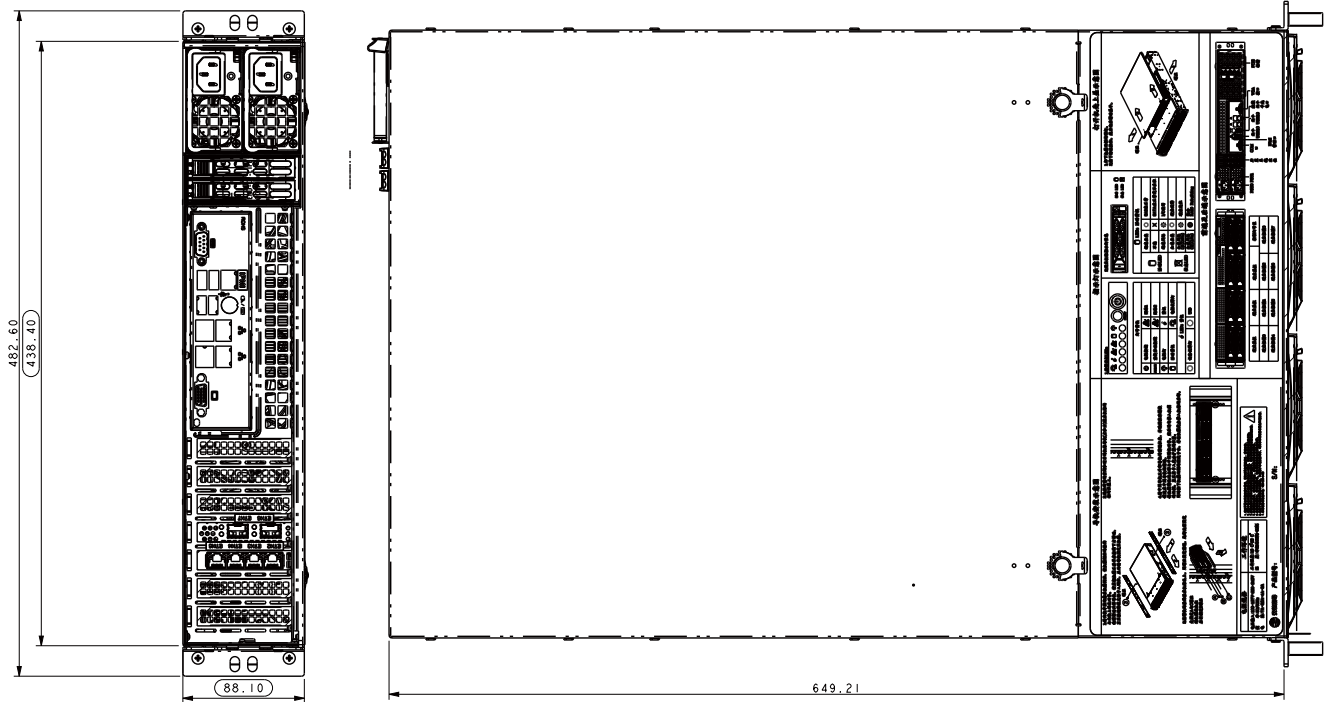

SCALE 1:2

Rack-mounting

IMPORTANT:

If you have either a round-holed or square-holed rack, install cage nuts or clip nuts to the desired positions on the rack posts.

The instructions below are based on the installation to a 4-post equipment rack.

1. Remove the inner rail from the slide rail assembly. There is a locking tab at the tip of the inner rail.

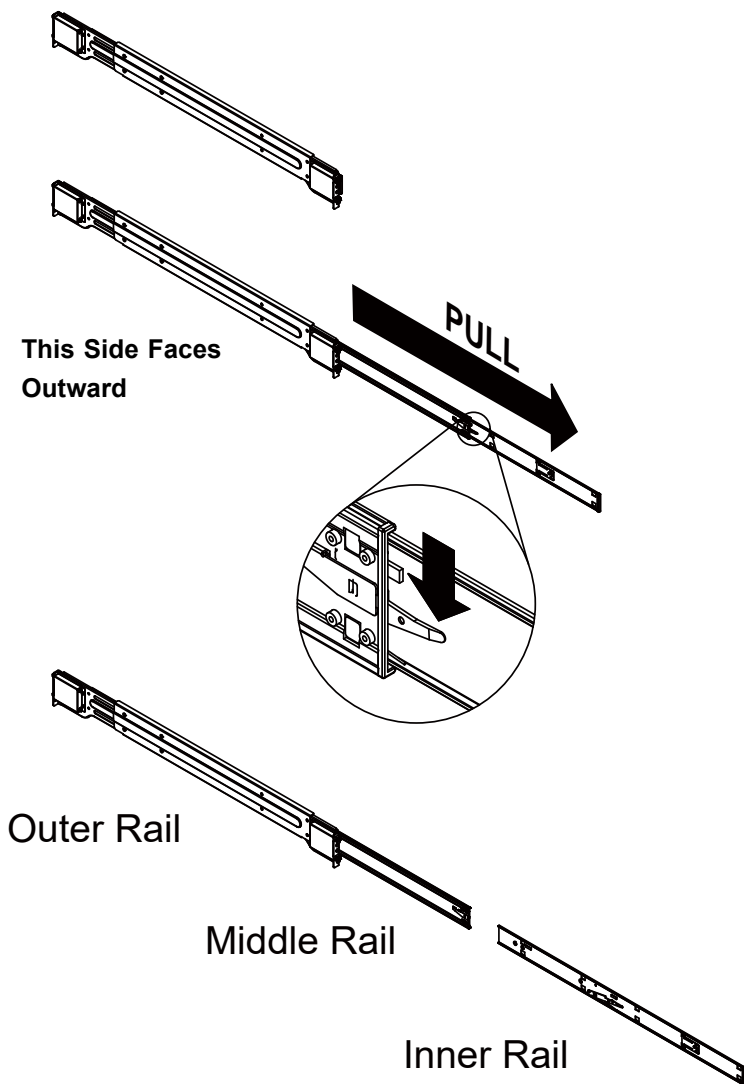

- Secure the inner rails to the sides of the chassis using the included screws. Place the inner rail firmly against the side of the chassis, aligning the hooks on the side of the chassis with the holes in the inner rail. Slide the inner rail forward toward the front of the chassis and under the hooks until the quick release bracket snaps into place, securing the rail to the chassis.

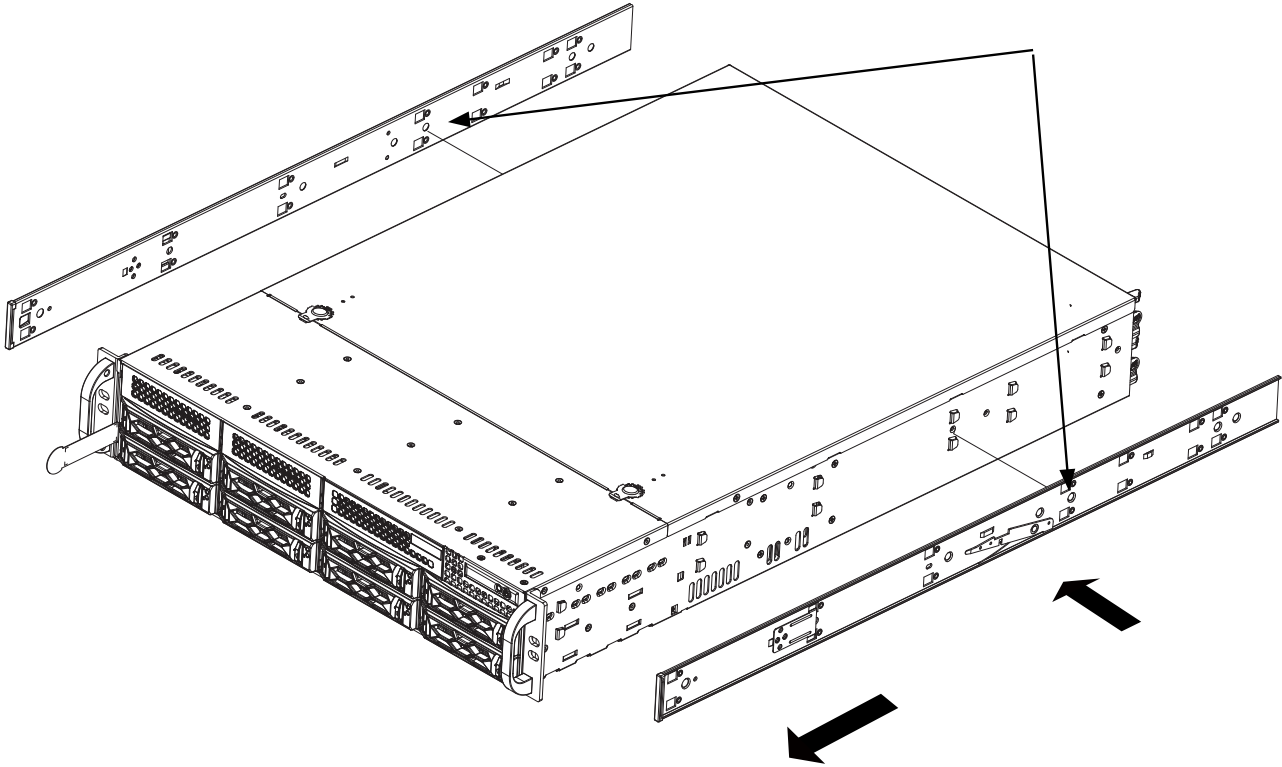

WARNING:

Do not pick up the server with the front handles. They are designed to pull the system from a rack only.

3. Pull upward on the locking tab at the rear end of the middle rail.

Push the middle rail back into the outer rail.

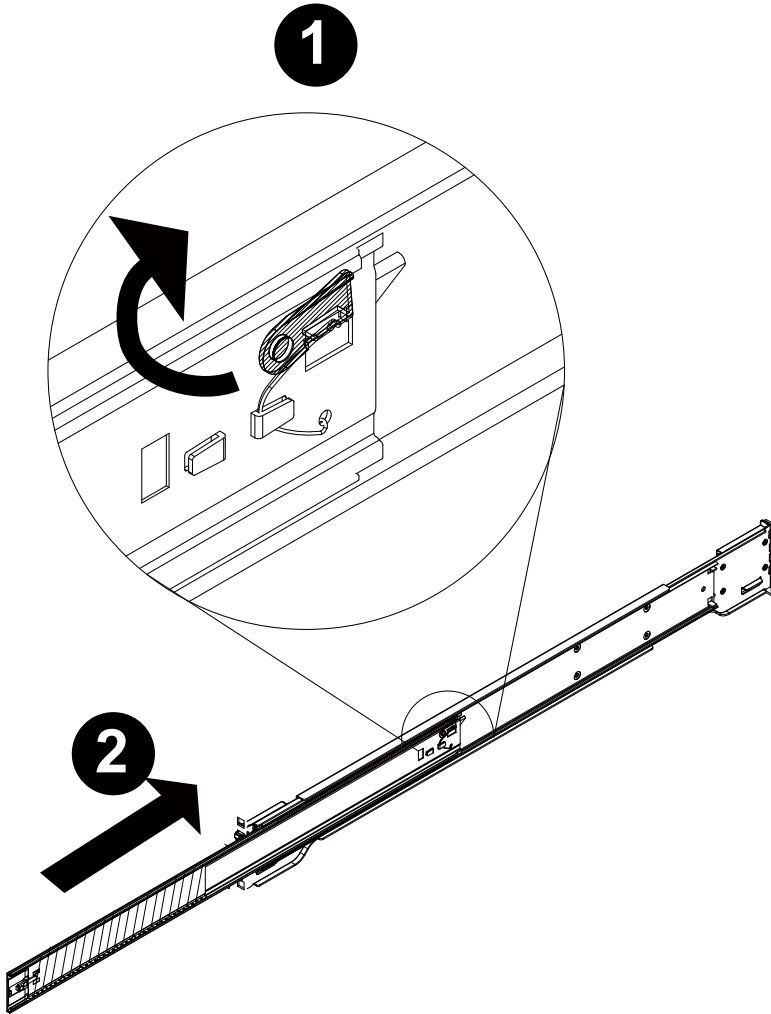

4. Hang the hooks on the front of the outer rail onto the square holes on the front of the rack. If desired, use screws to secure the outer rails to the rack.

It is important to check if the safety lock is in the unlocked position before mounting the brackets.

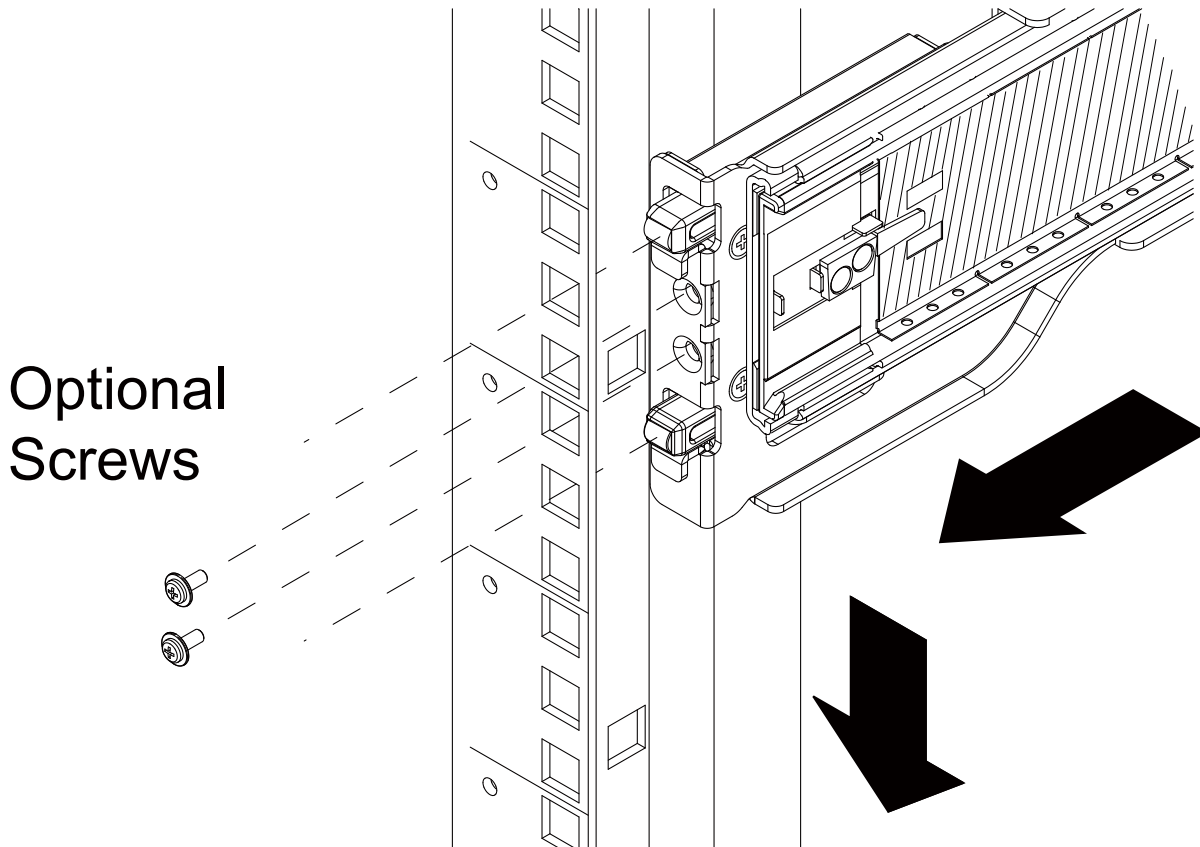

5. Pull out the rear of the outer rail, adjusting the length until it just fits within the posts of the rack.

Hang the hooks of the rear section of the outer rail onto the square holes on the rear of the rack. Take care that the proper holes are used so the rails are level. If desired, use screws to secure the rear of the outer rail to the rear of the rack.

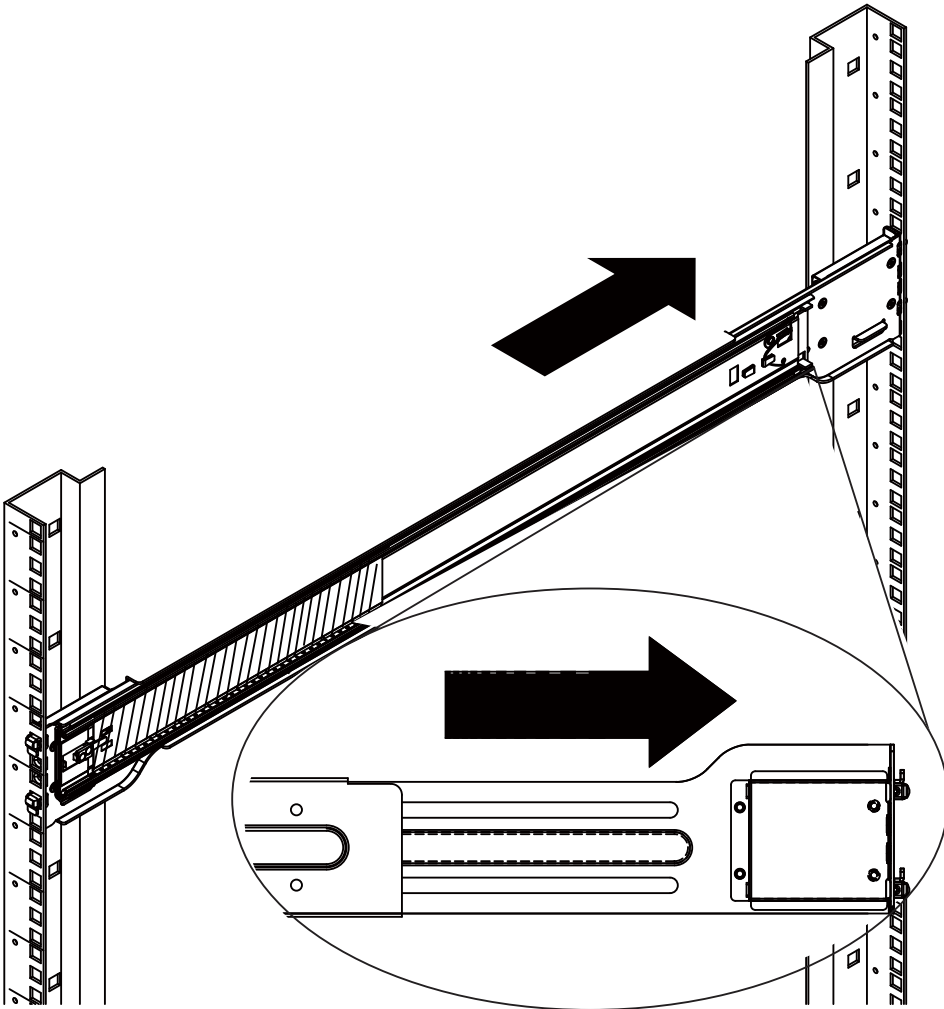

6. Pull the middle rail out of the front of the outer rail and make sure that the ball bearing shuttle is locked at the front of the middle rail.

Align the rear of the chassis rails with the middle rails and then push evenly on both sides of the chassis until it clicks into the fully extended position.

Depress the locking tabs on both sides of the chassis and push the it fully into the rack. The locking tabs should "click".

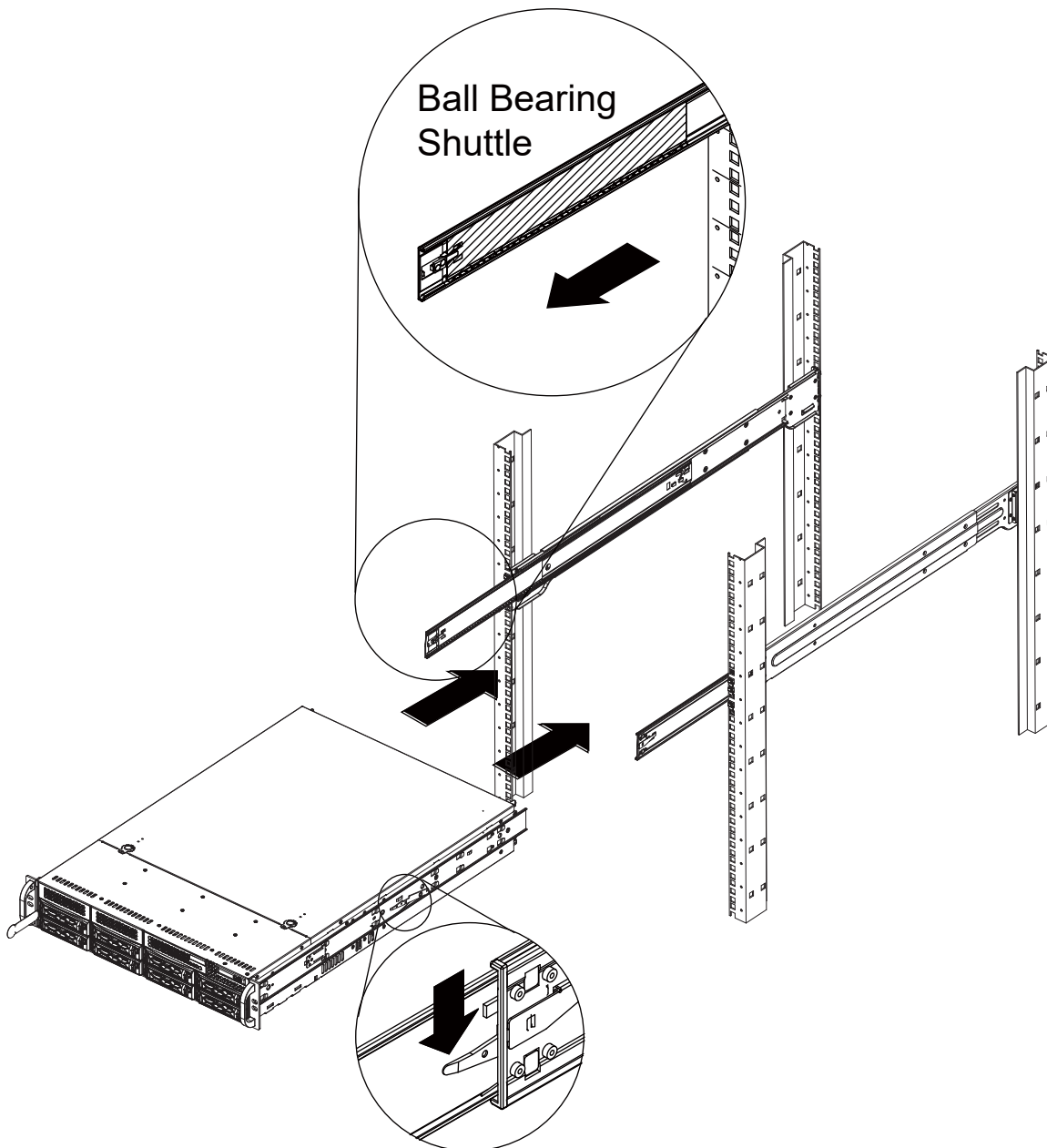

Note: Keep the ball bearing shuttle locked at the front of the middle rail during installation. Note: Figure is for illustrative purposes only. Always install servers to the bottom of a rack first.

Installing Hard Disk Drives



IMPORTANT:

- Refer to VIVOTEK's website for the hard disk compatibility information.
- Avoid touching the hard drive's circuit board or connector pins. Doing so can damage the hard drive by electro-static discharge.

1. Press the release button on the drive carrier. This extends the drive carrier lever.

2. Use the lever to pull the carrier out of the chassis.

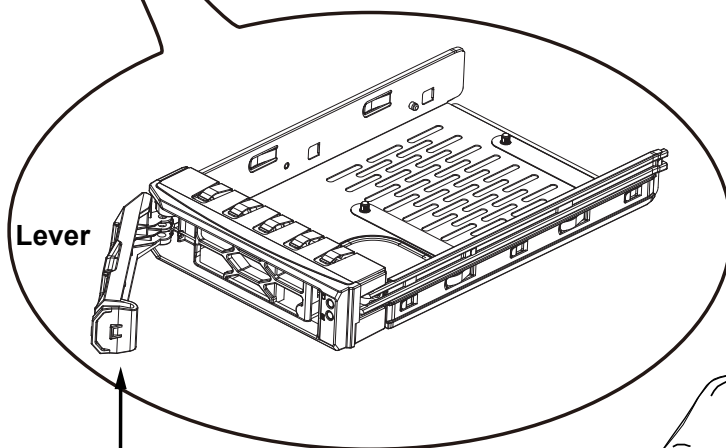
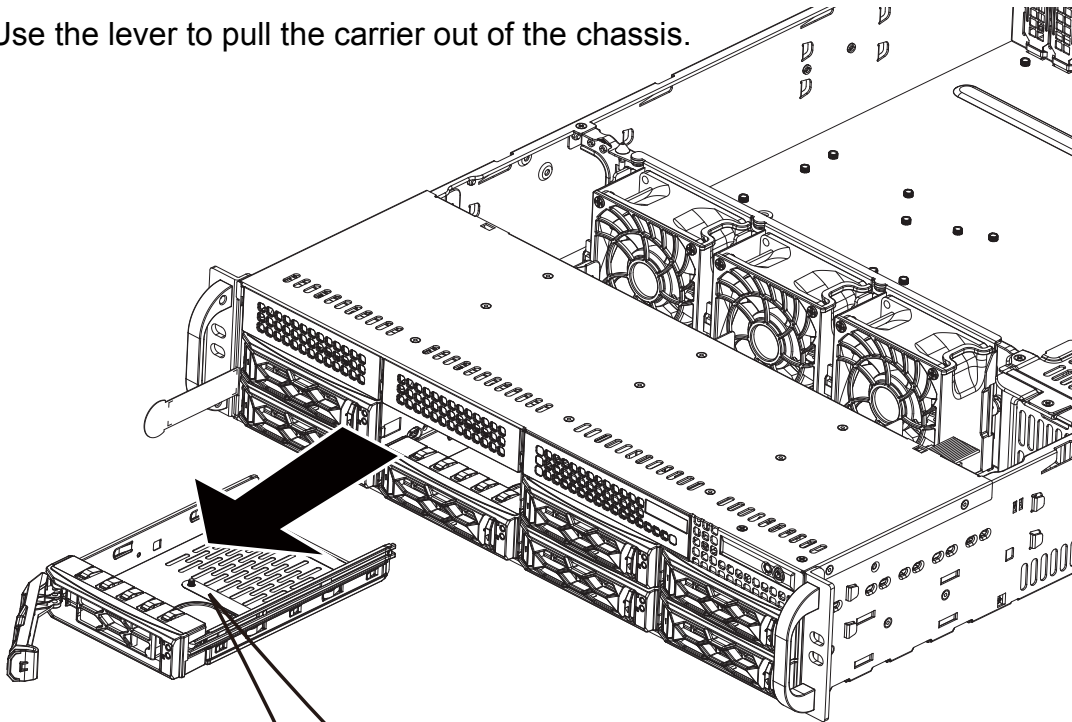

Lever

Release Button

It is recommended to wear an anti-static wrist strap when handling hard drives.

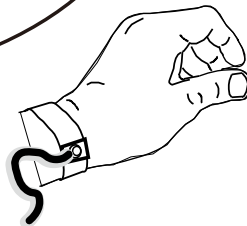

3. Insert a 3.5" hard drive in an angle into the carrier, so that the mounting holes on the right side of the drive align with the two stubs in the drive carrier. Insert this side into the drive carrier first, then push the other side into the drive carrier completely.

Insert this side first

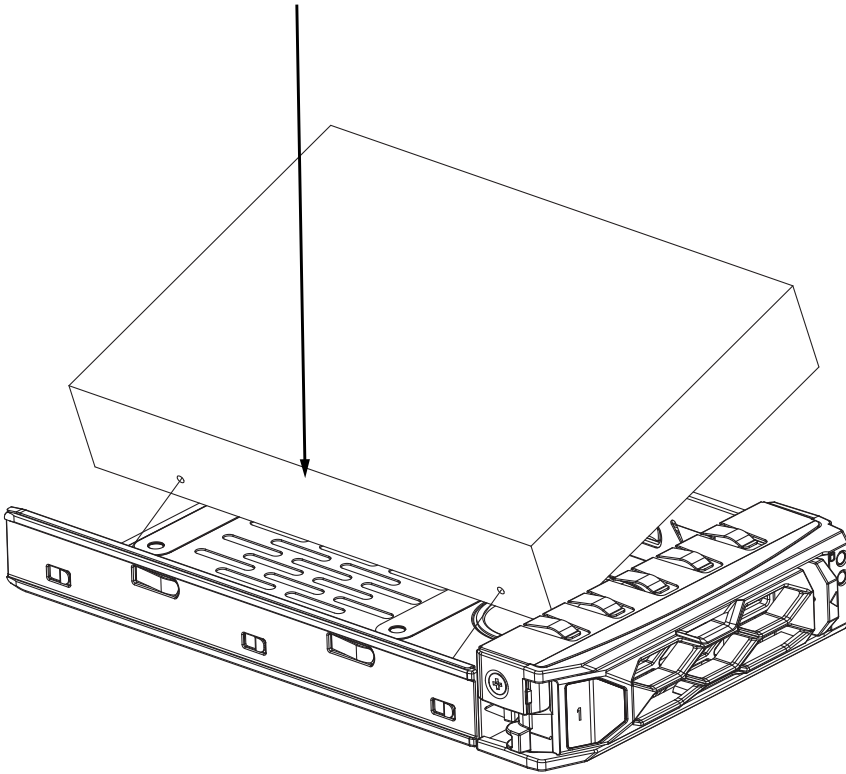

3.5" Drive

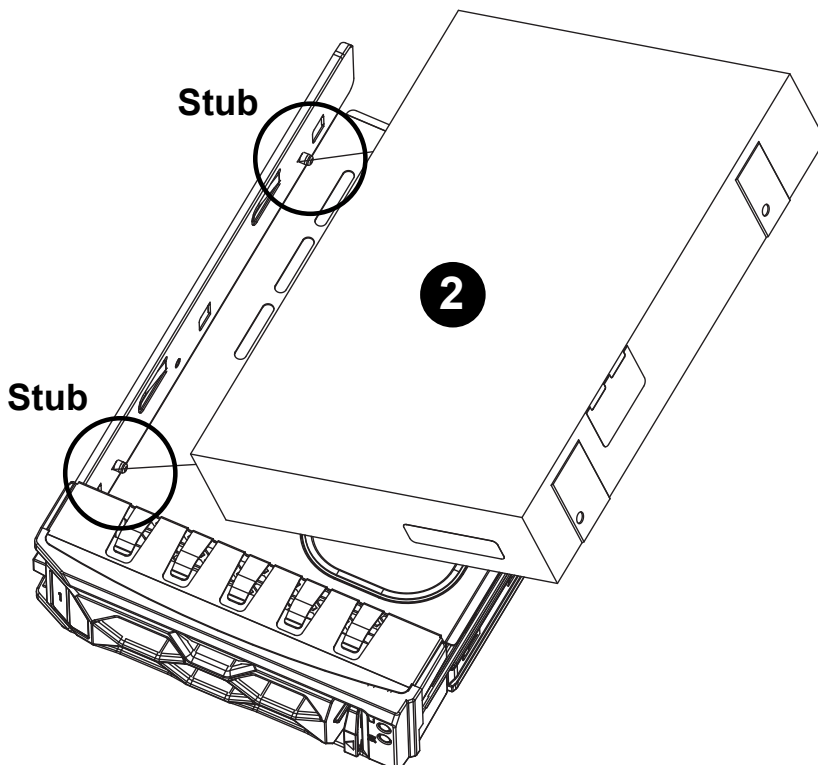

4. Press down on the other side for the hard drive to snap into place.

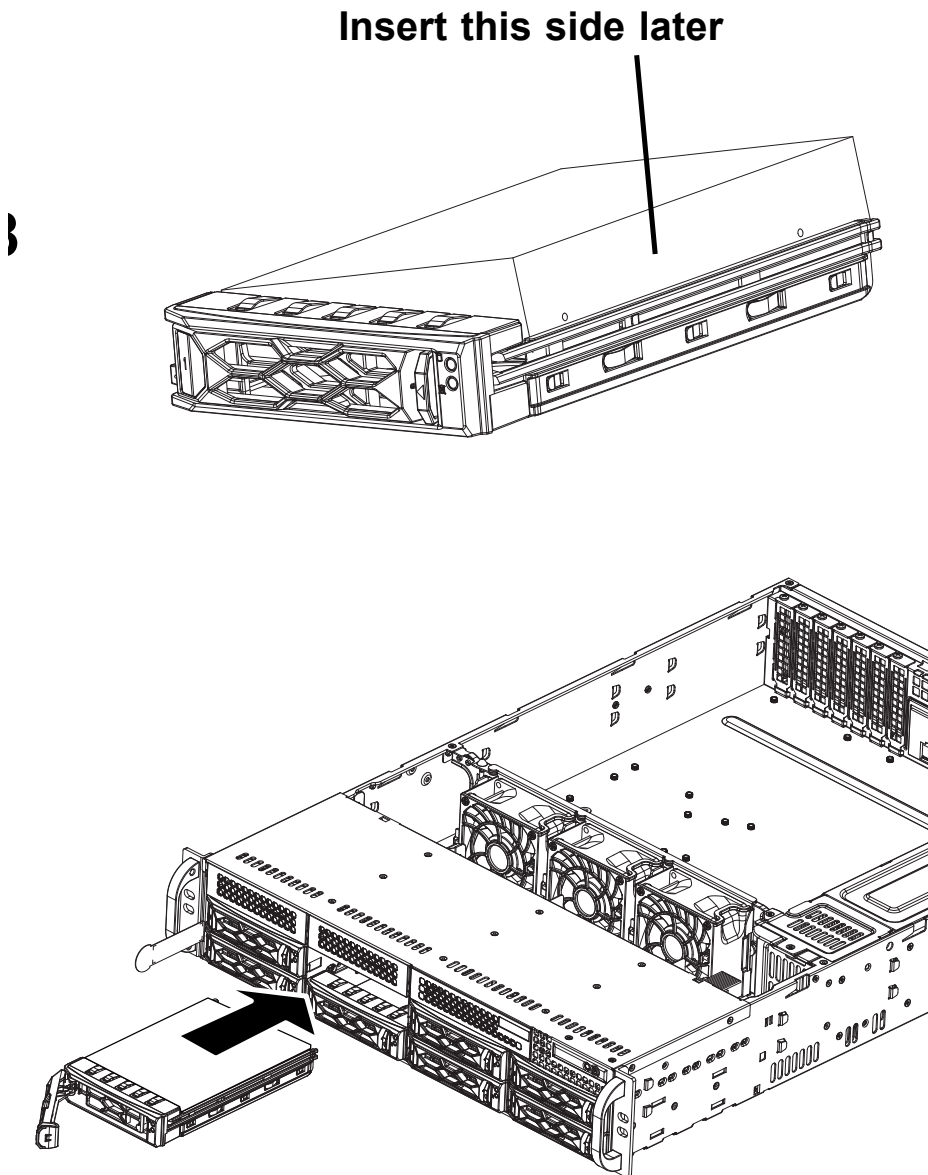

If using 2.5" hard drives, the 4 screws necessary for installation are user-supplied.

Connecting Interfaces

Refer to page 14 for the interface connections.

1. Make sure all cameras have been properly installed, either they are powered by 12V power lines or using one or several PoE switches or mid-spans. Refer to the cameras' documentation for details.
2. Connect all other interfaces to USB mouse/keyboard, one or two monitors, and audio input/output devices.
3. Make sure you connect both power supplies to power mains. An alarm will be sounded if you connect only 1 of the power supplies.

Initial Configuration

1. Power up the system by pressing the power on button.

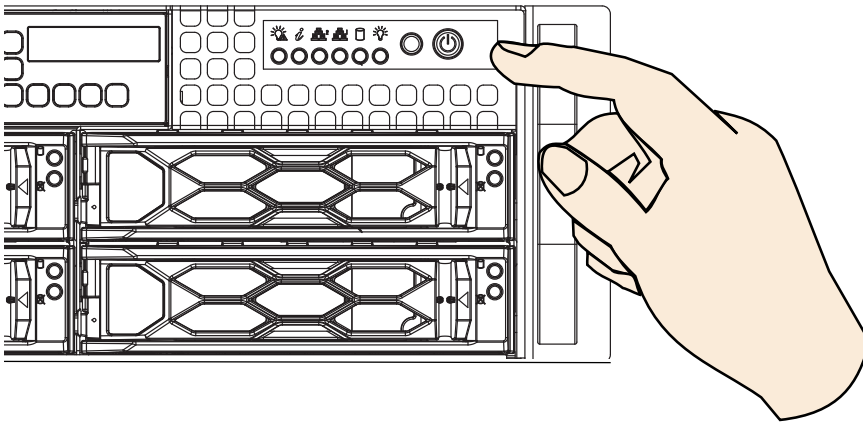

2. Skip the BIOS screens and select **Enter NVR** at the selection screen. The system will start. Wait for the start-up process to complete.

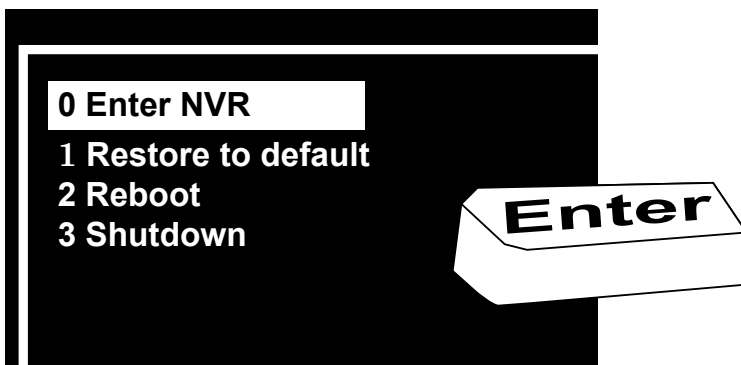

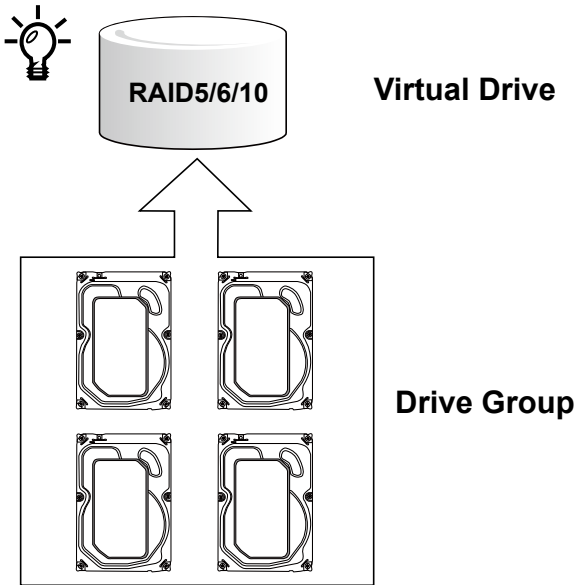

Our default recommendation is to combine 4 hard drives into 1 drive group. The capacities of these drives will be utilized to form 1 Virtual Drive. If all 16 drive bays are populated, you can create 4 Virtual Drives. A 4-member Virtual Drive can receive the video feeds from 32 cameras. You can also create two 8-member Virtual Drives to receive the video feeds from 64 cameras (CH, or channels.)

Recording will not take place unless you create a Virtual Drive first. Select RAID5 as the RAID level during the configuration process.

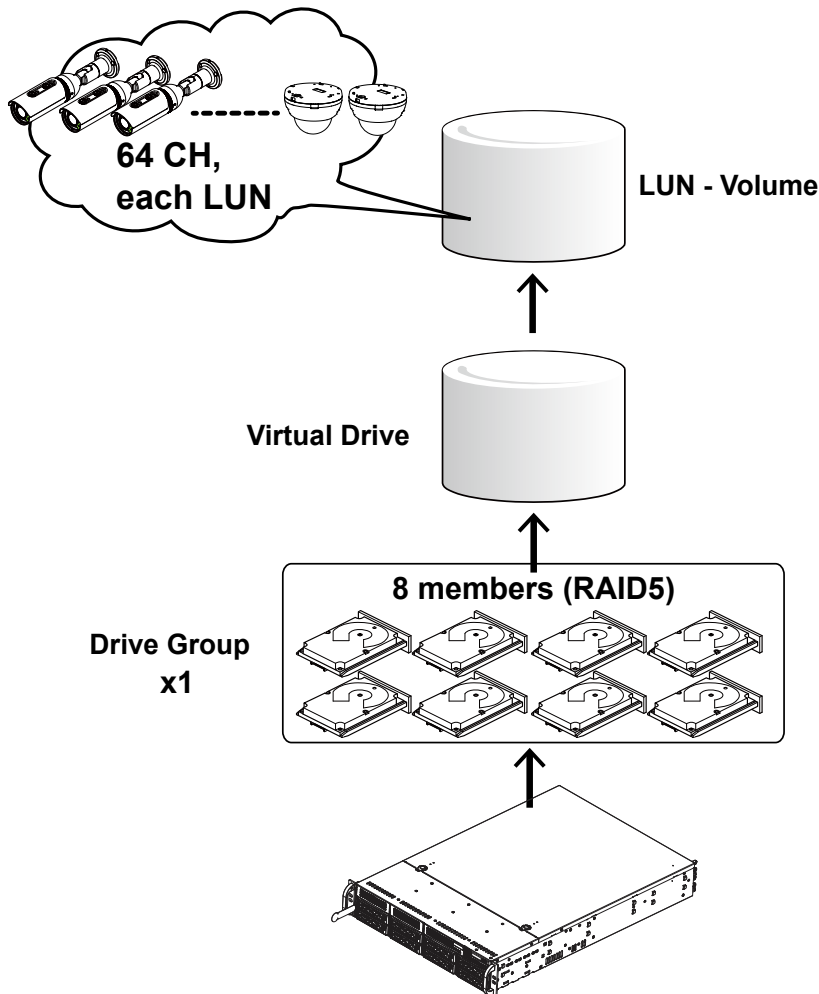

The default configuration for a configuration of 64 cameras should look like the following:

Physical & Logical components	Configuration
Hard drive	8
Virtual Drive	1, each has 8 members. Configured in RAID5. If using 6TB drives, the available capacity in each Virtual Drive will be, $8 \times 6TB - 1 \times 6TB(\text{parity drive}) = 42TB$.
Volume	2, each created from 1 Virtual Drive.

The camera configuration should look like this,

Physical & Logical components	Configuration
Cameras	64
Recording Group	1, each responds to 32 or 64 cameras, and each Recording Group is associated with 1 Virtual Drive volume.
Volume	1, each created from 1 Virtual Drive, and associated with 1 Recording Group. .

A Virtual Drive appears to the host system (Windows) as a logical disk partition. The logical partition, when formatted, becomes a disk volume.

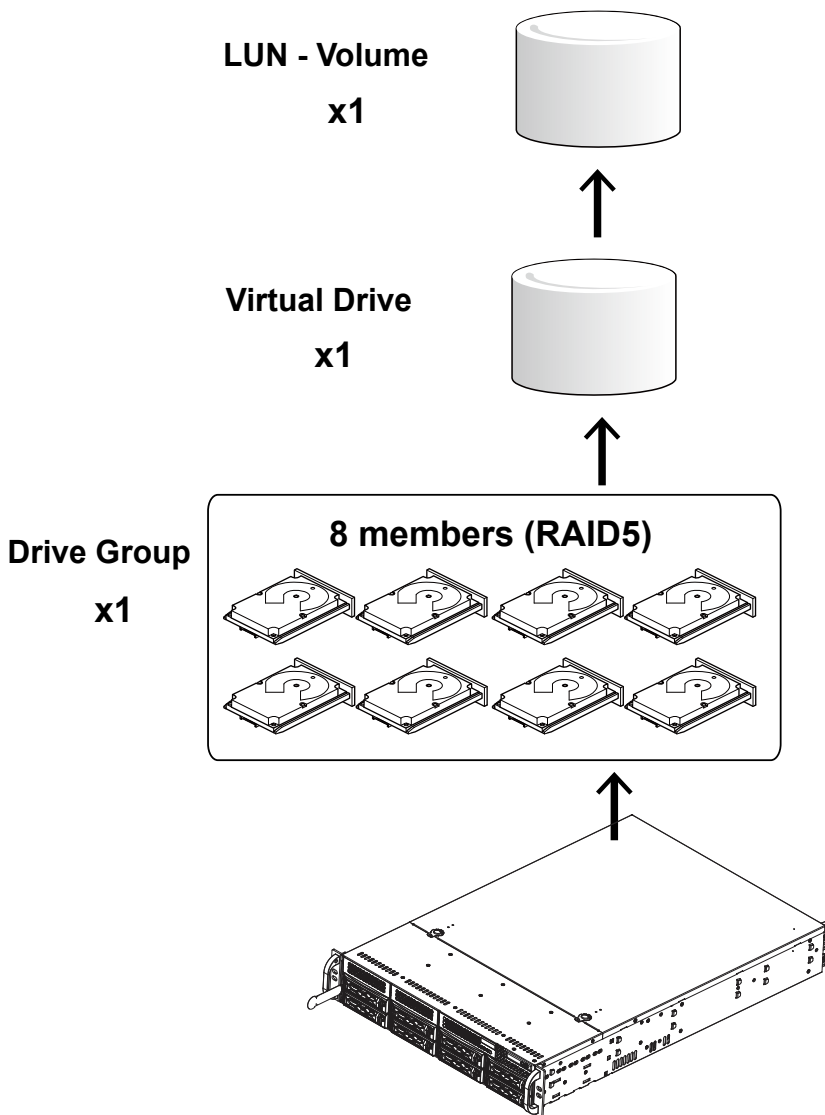

1. The system will boot up to the system main screen. Double-click on the **RAID Config** shortcut to start the MegaRAID storage configuration utility.



Ctrl + Alt + F12 ->

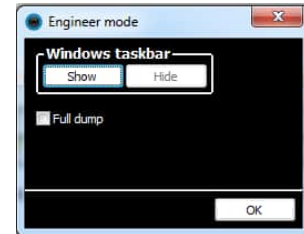

2. Select the default server, namely, the Windows 7 server running on this machine. Click Login to begin your configuration.

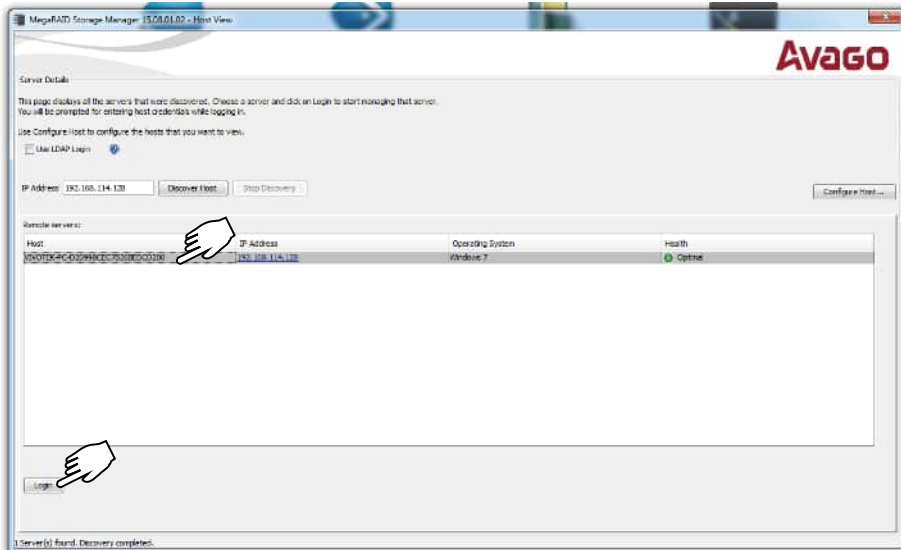

3. Enter **vivotek/vivotek** as the User Name and Password. Click Login to proceed.

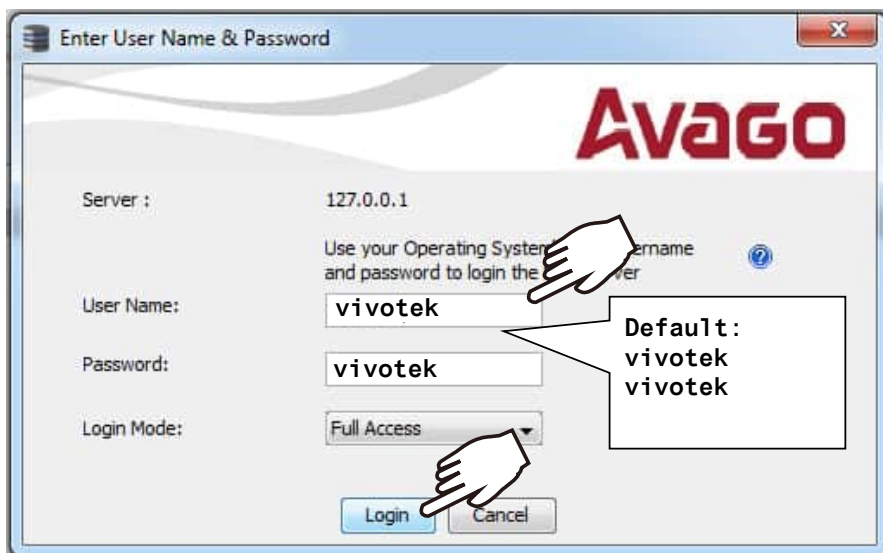

4. A Dashboard view will appear. Click the **Logical** tab.

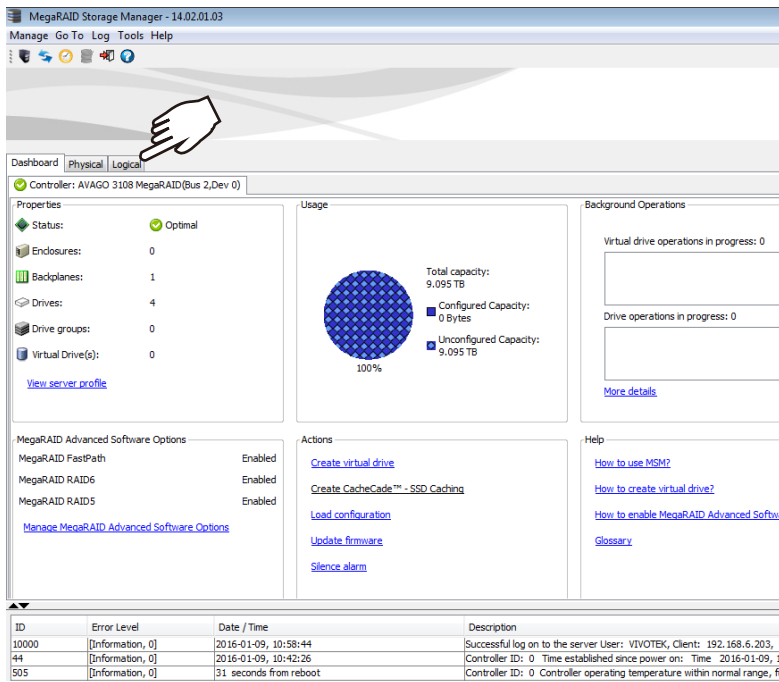

5. Left-click to select the AVAGO MegaRAID controller, and then right-click to display a command menu.

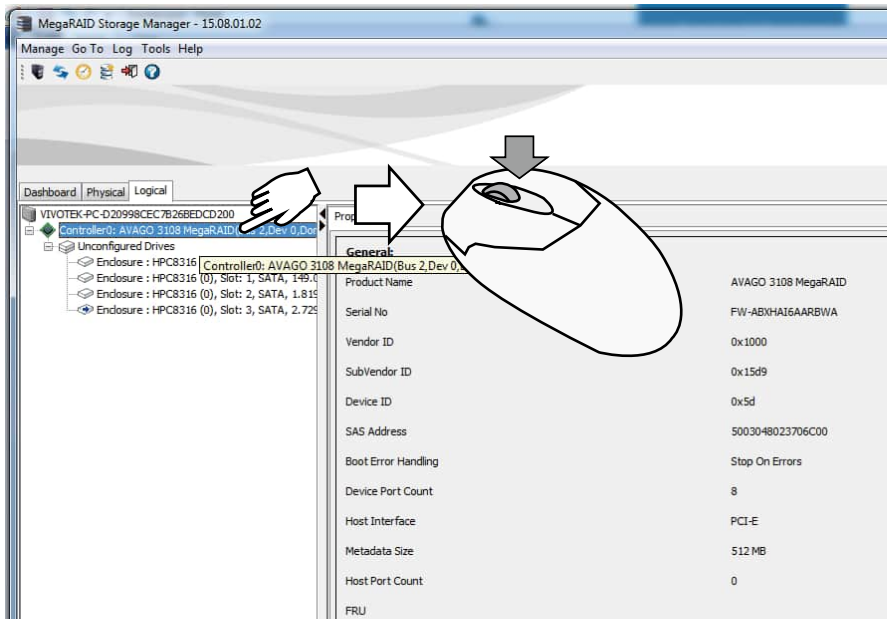

6. Click on **Create Virtual Drive**.

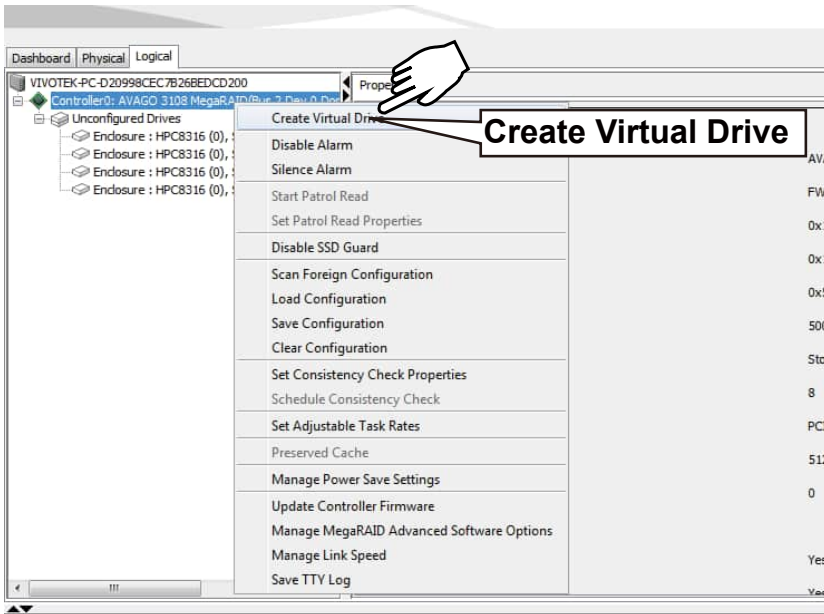

7. The **Create Virtual Drive** wizard will start. Click to select the **Advanced** mode. Then click the **Next** button to proceed.

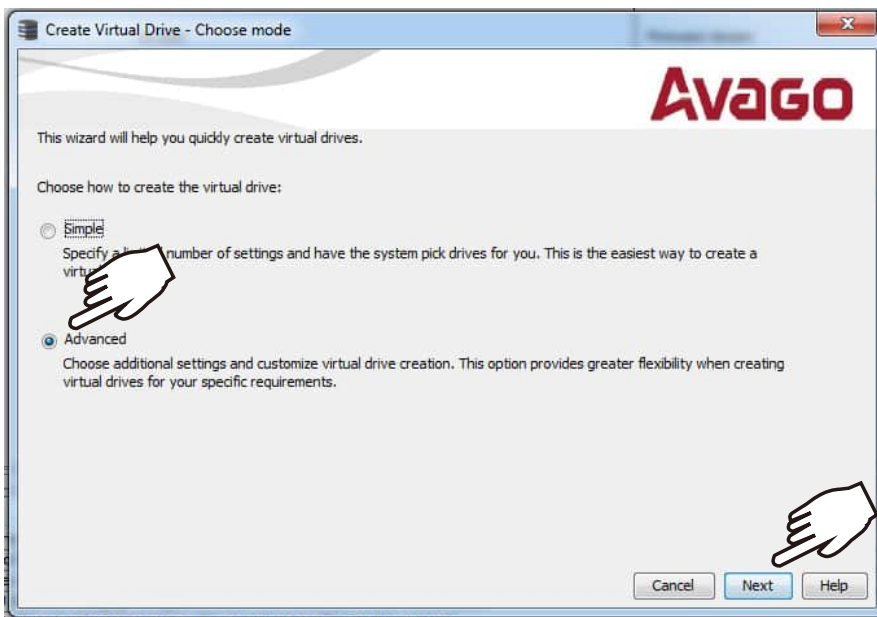

8. Select a **RAID level**, and then select multiple disk drives as the members of your drive group. Left-click to select a disk drive, and click **Add** to add it to group. You do not need to select the Data protection option.

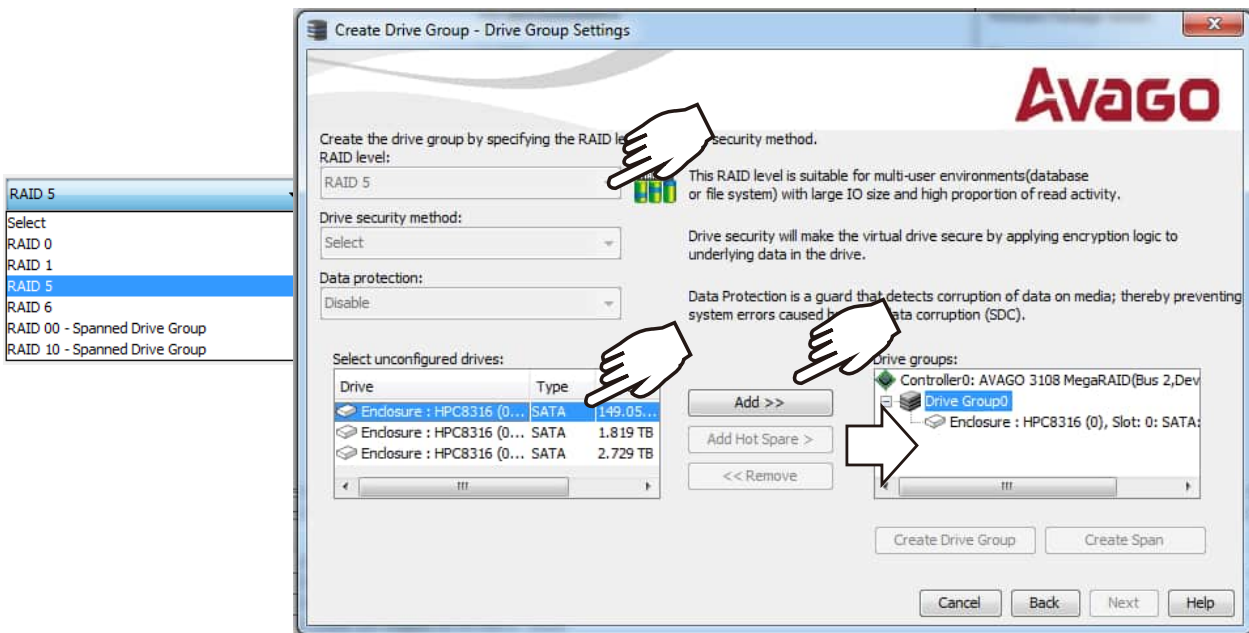

Refer to the next section: **RAID Basics** on page 44, for details about RAID levels.

9. Click on the Drive Group 0 entry you have just configured. The **Create Drive Group** button will become available. Click Next to proceed.

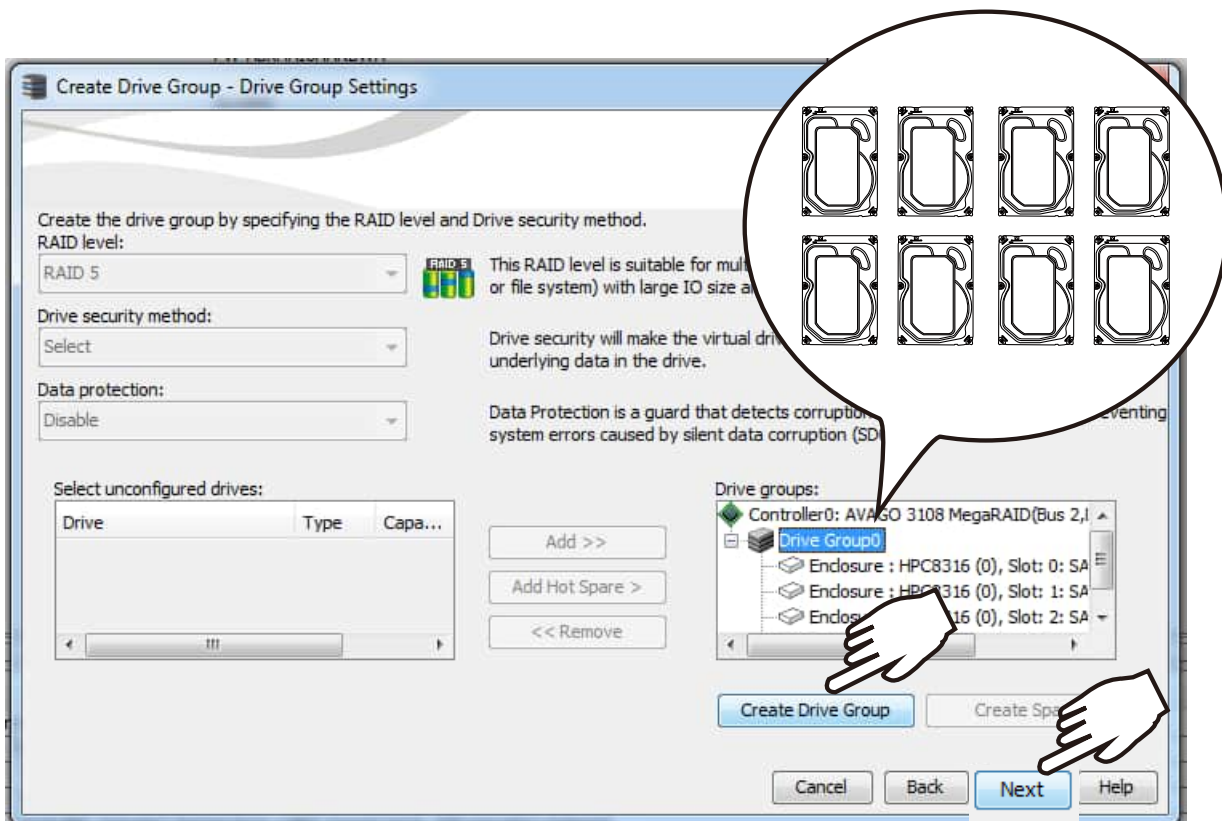

9. Select the following key parameters:
 Initialization State: **Fast Initialization**,
 Strip size: **64KB**,
 RAID policy: **No Read Ahead**,
 Write policy: **Always Write Back**.

These are important parameters to the disk array performance, and have to be correctly configured. Click **Create Virtual Drive**.

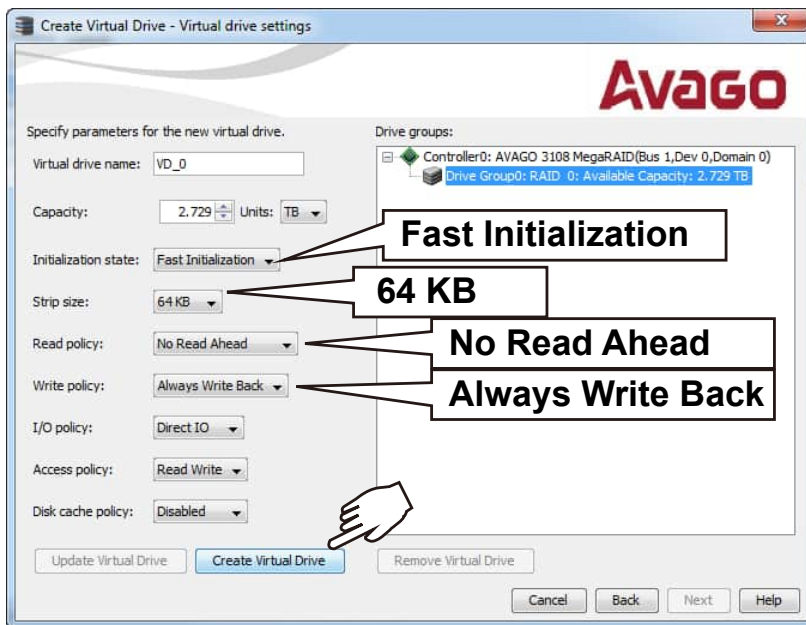

10. Click **Yes** to leave the Write Back concern message.

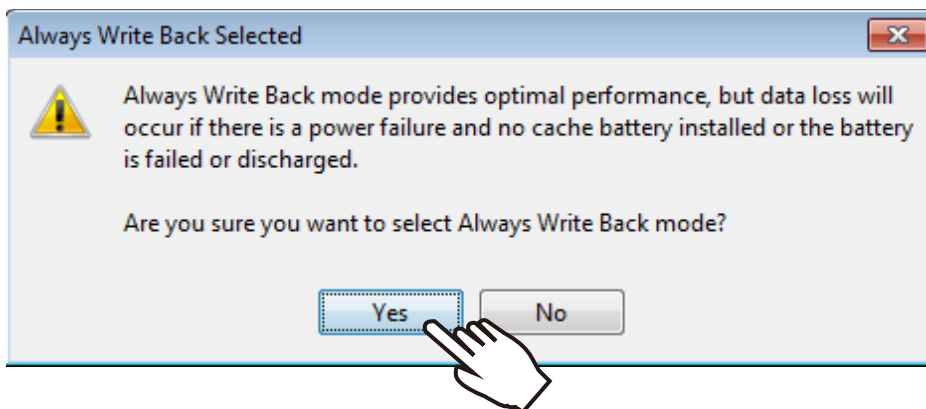

11. The wizard may prompt for another virtual drive. Multiple virtual drives can be created from a physical drive group. Repeat the process to create more 4-member Virtual Drives. When done, click to select the **Virtual Drive 0,VD_0**, and then click **Next** to proceed.

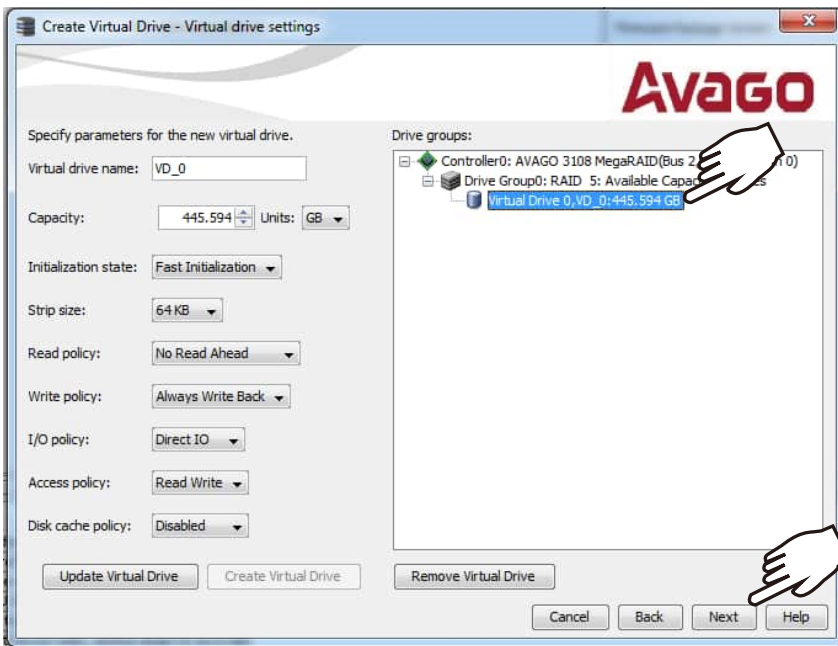

12. The Virtual Drive is instantly created. Click **OK**, and then click **Finish** to close the wizard. You can then terminate the MegaRAID utility.

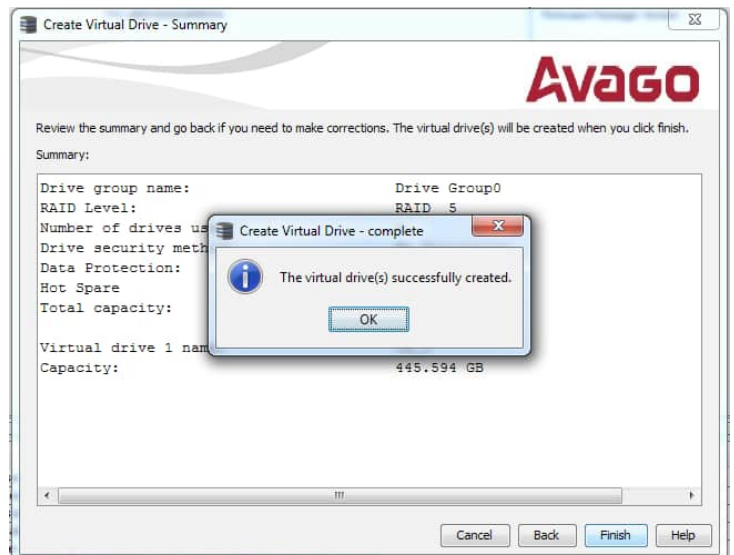
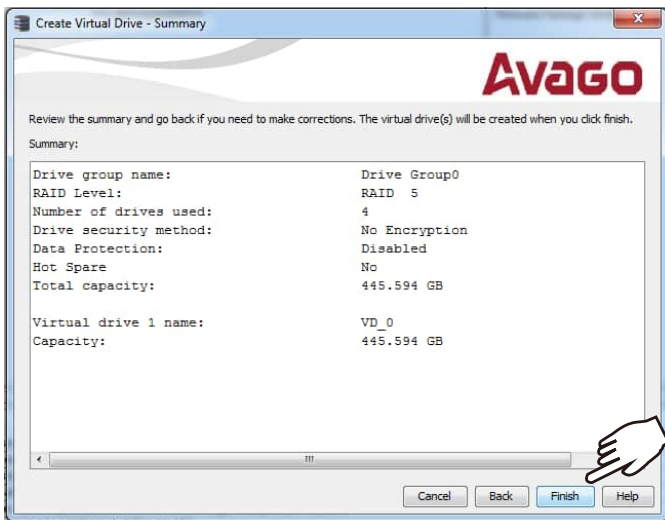

13. Double-click on the **Disk Management** shortcut on the desktop to open the utility.



14. The virtual drive you created should appear as a new disk partition. You need to initialize and format the partition before using the disk capacity. Left-click to select and then right-click to display the command menu. Click **Initialize Disk** to proceed.

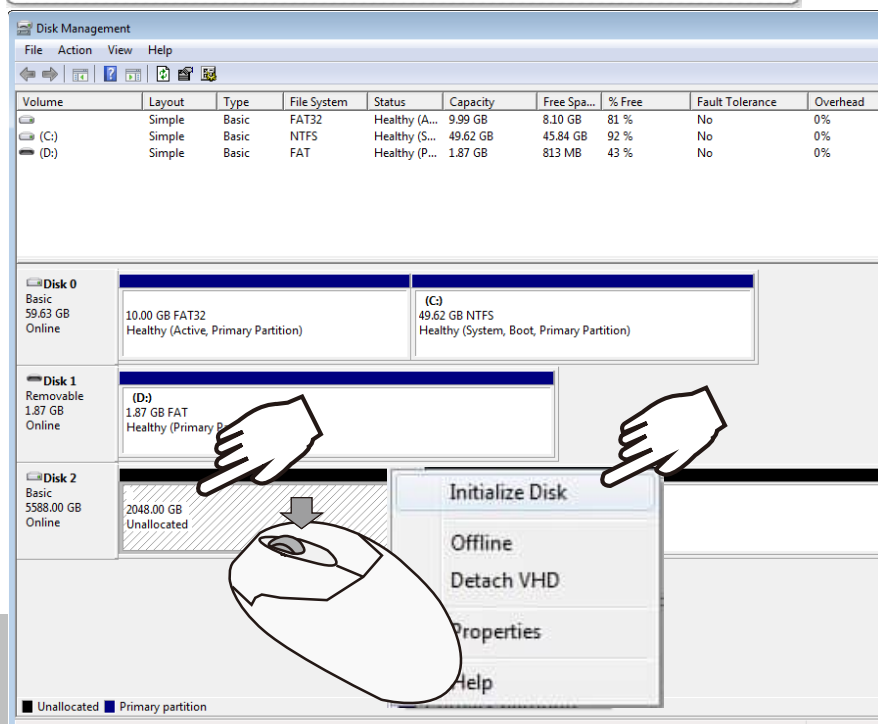
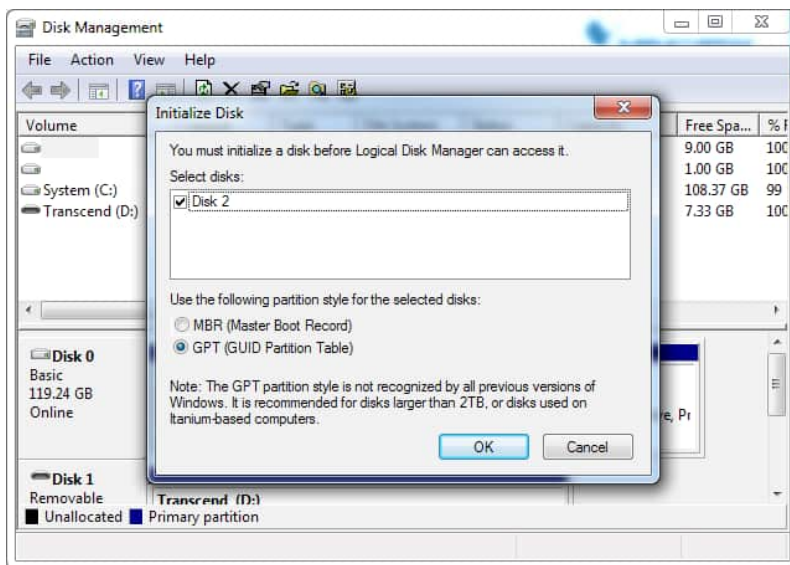

15. Select **GPT** (GUID Partition Table), and then click **OK** to proceed. This window may automatically pop up when Disk Management is started.

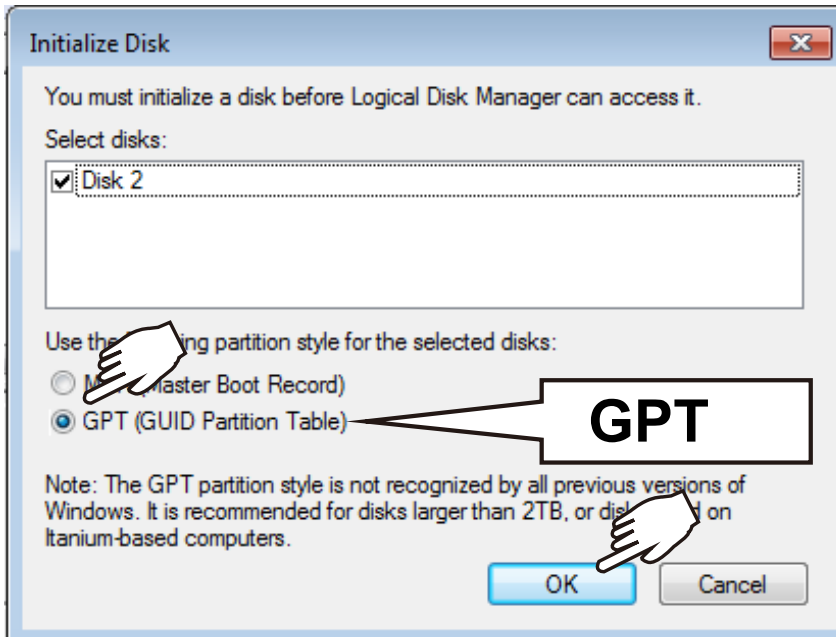

16. Once initialized, you can create a new volume. Right-click to display the **New Simple Volume** command. Click to proceed.

Please do not format drive C:. Doing so will disable the system.

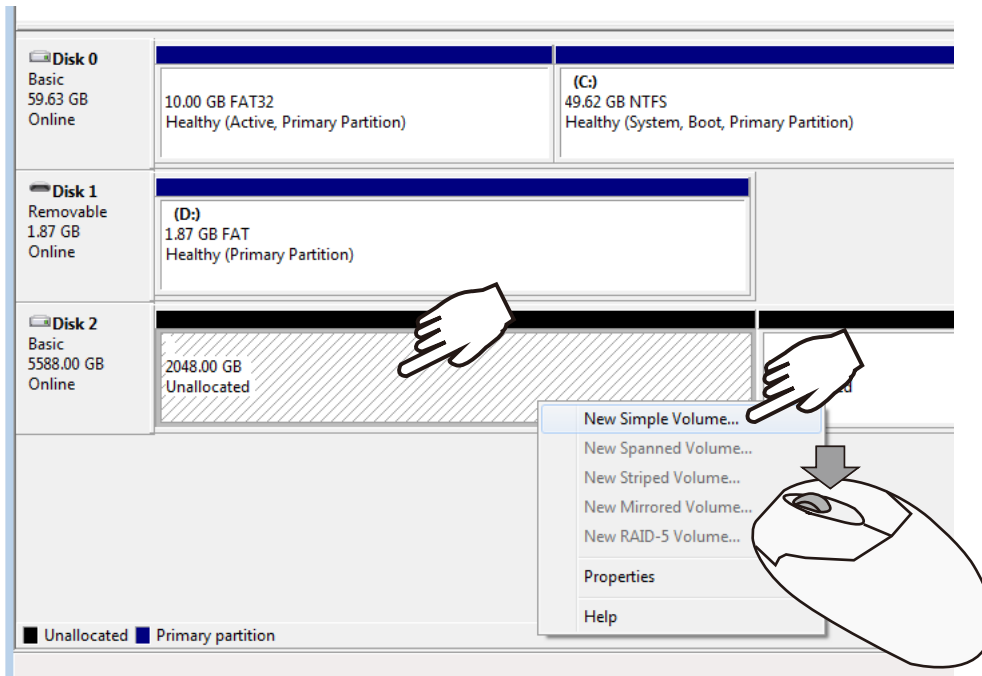

17. The **New Simple Volume Wizard** will prompt. Click Next to proceed.

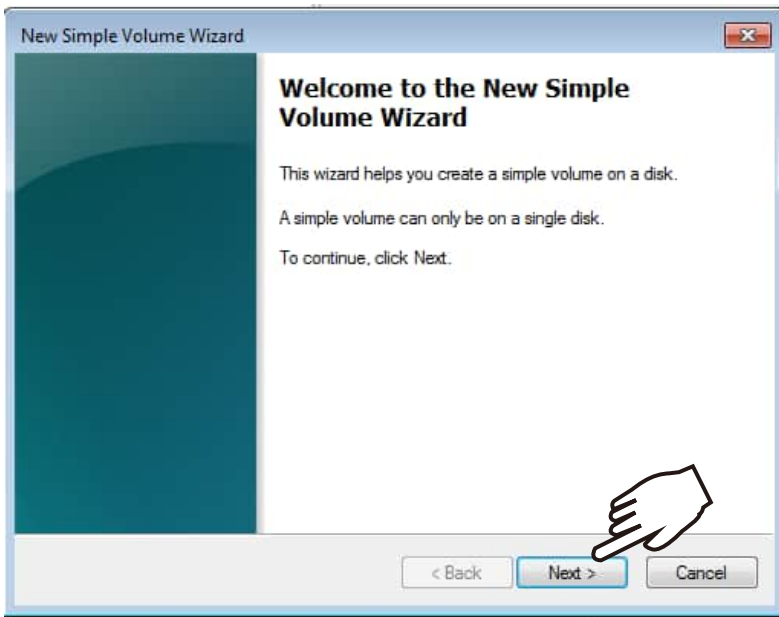

18. Leave the volume size unchanged. Click Next to proceed.

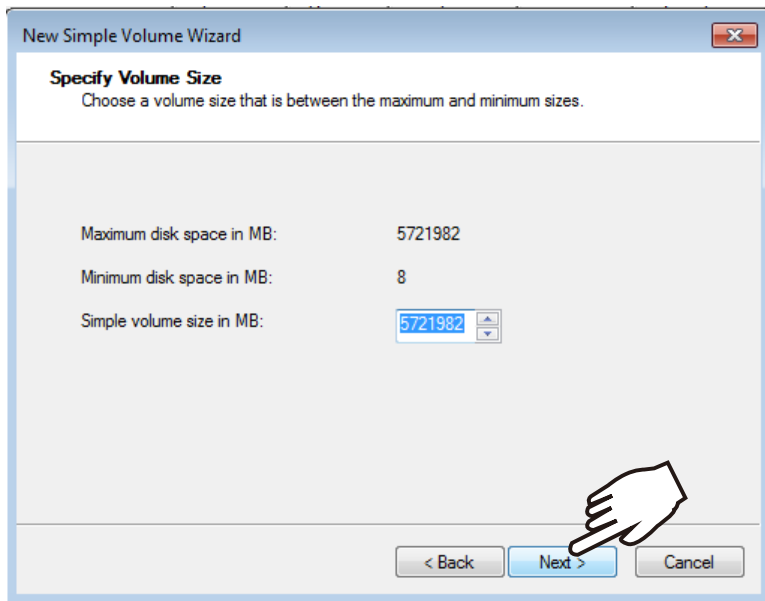

19. When prompted to assign a drive letter, click Next to proceed.



20. On the **Format Partition** page, select the **Allocation unit size** as **64KB**. When done, click Next to proceed.

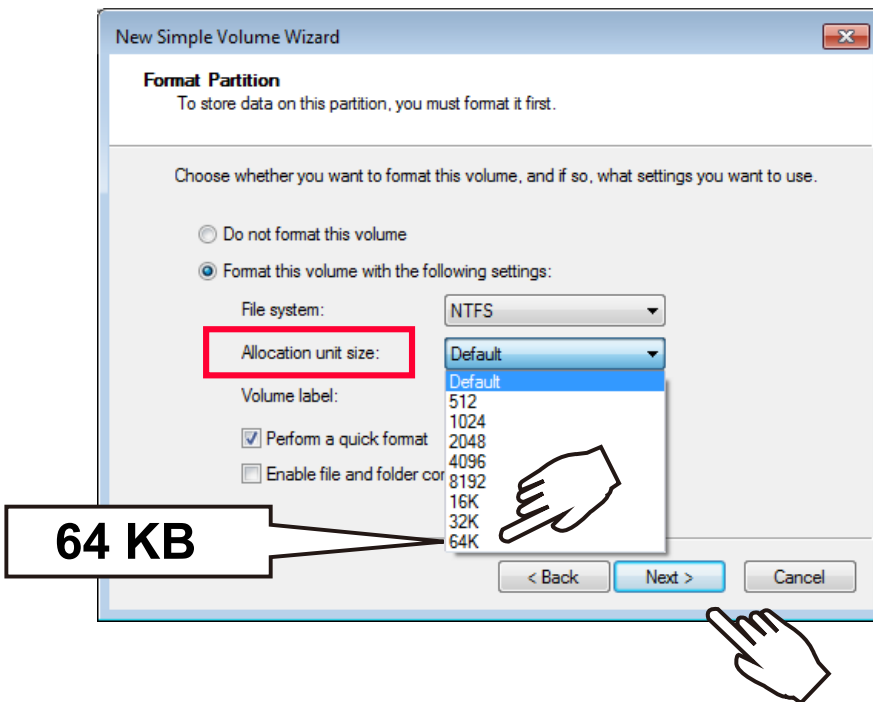

21. Click Finish to end the wizard.

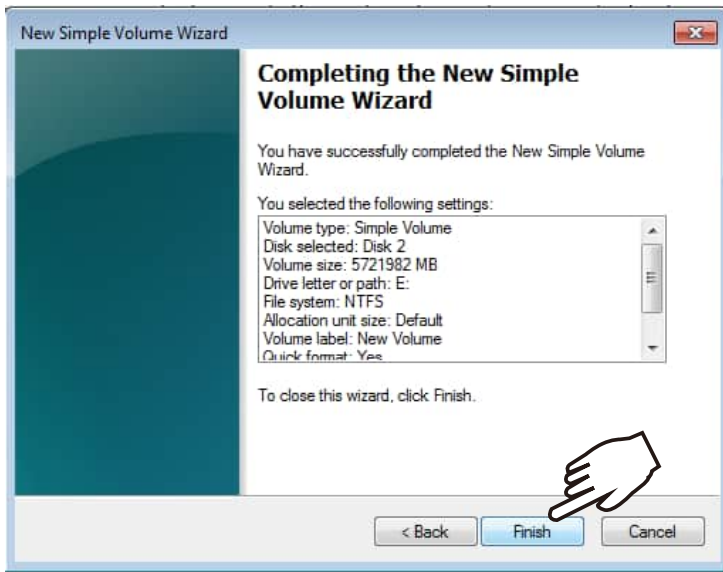

22. The formatting process will run in the background. When done, the new volume shall be indicated as a healthy new volume. Close the Disk Management window.

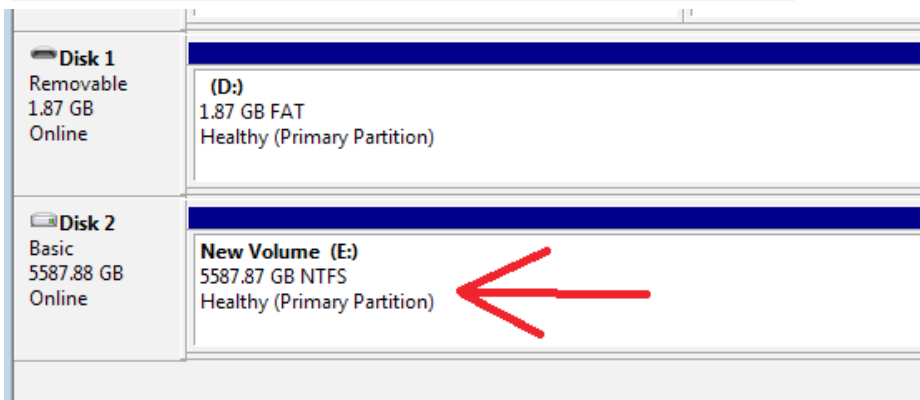
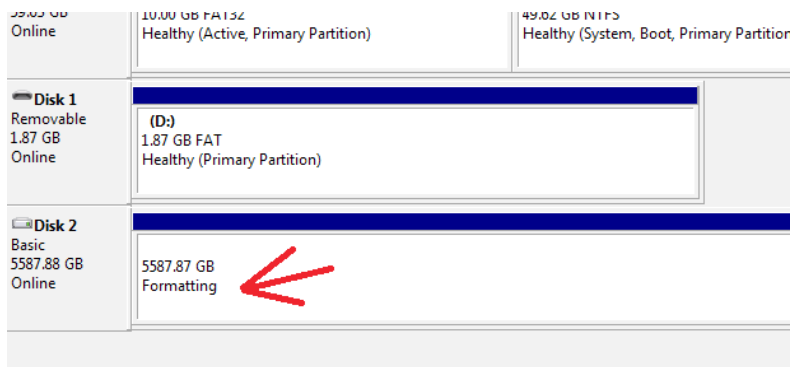

23. Start VIVOTEK **VAST** management software by double-clicking its shortcut. Enter **admin** and **admin** as the User Name and default Password. You can change the password later in the utility. Click **Log in** to proceed.

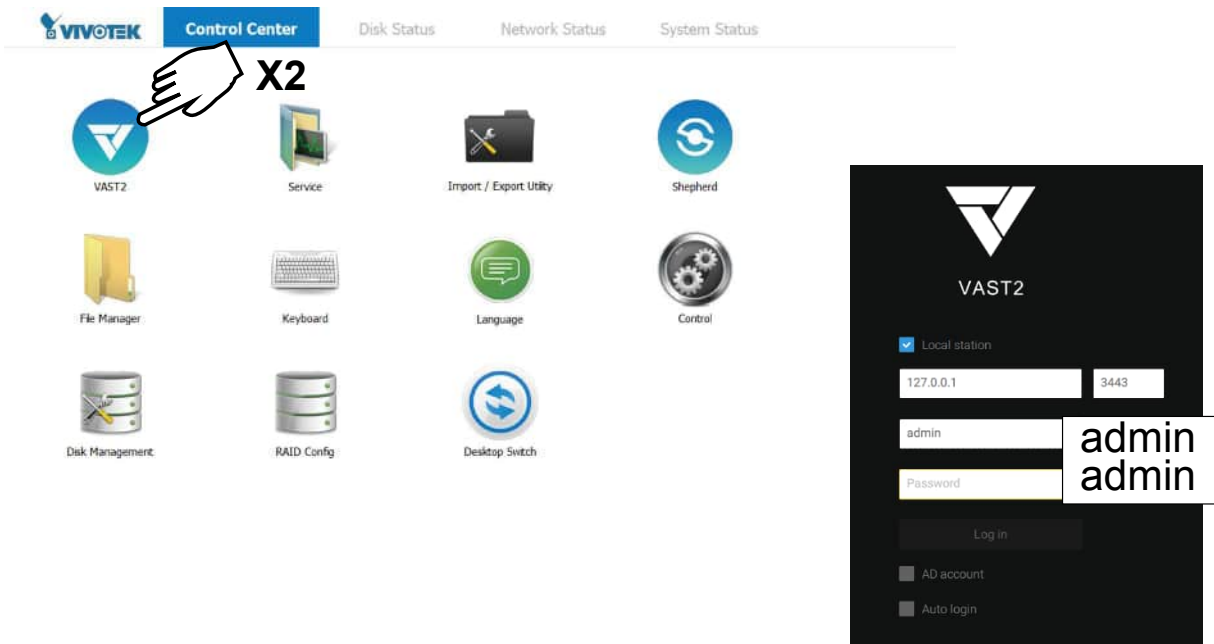

<p>Top row</p>	<p>Control Center: the default desktop. Disk Status: Displays the current storage volume status (system drive and RAID volumes). Network Status: Displays the information for the current network connections. System Status: Displays the current system status, license information, and VAST service.</p>	
<p>Desktop Shortcuts</p>	<p>VAST2 Service Import/Export Shepherd File Manager Keyboard Language Control Disk Management RAID Config.</p>	<p>Starts the VAST2 recording and management software. Enables you to start, stop, or restart the VAST server instance. Allows you to import or export VAST configurations. Use the Shepherd utility to locate cameras within your network. Provides access to the files in system disk drive volumes. Toggles the virtual keyboard in case you do not have a physical keyboard. Changes the UI language. . Opens the operating system's control panel. Starts the Disk Management utility in Windows. Starts the RAID card storage configuration utility.</p>

24. The first time the VAST2 server is started, a configuration wizard will prompt to guide you through the basic configuration. Select drive **E:/** as the default location for the server database.

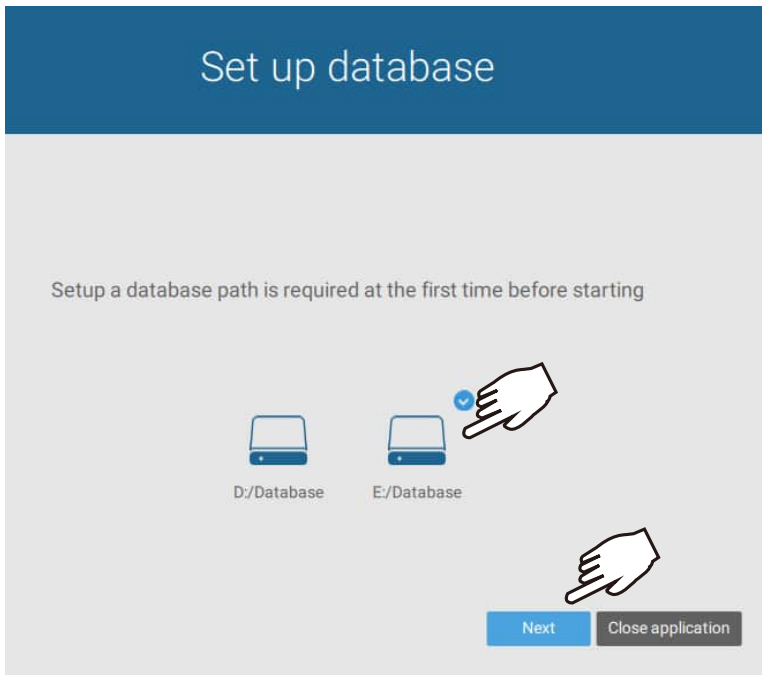

25. The next screen provides a list of all cameras in the local network. Select the cameras of your choice. Enter the credentials for making the connection with the network cameras. When done, click the **Next** button to proceed.

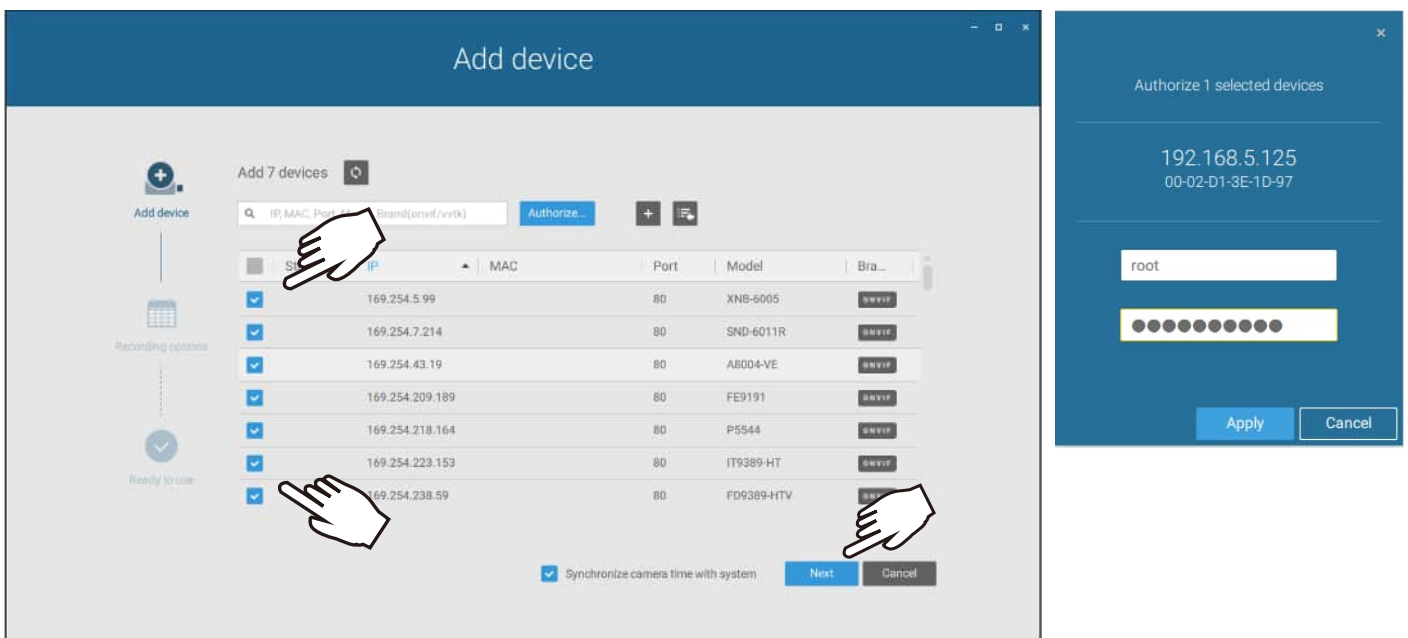

26. Select the recording volumes, such as the E:/ volume you just created. When done, click the **Ready to use** button.

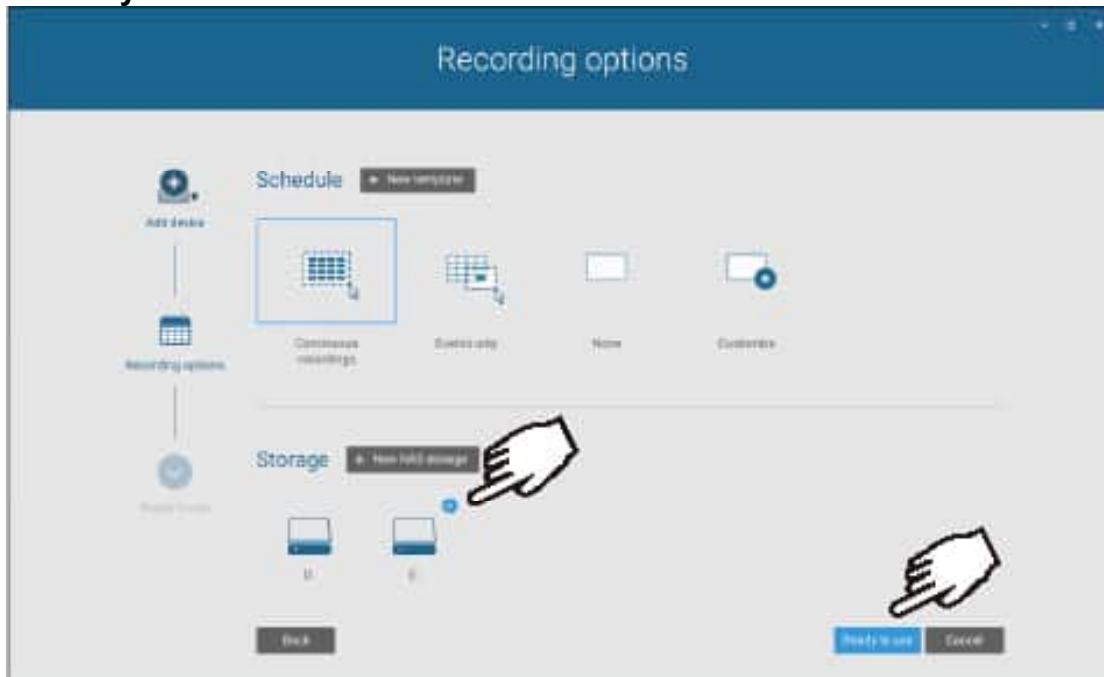

27. You should then enter the Liveview of the VAST2 software. Follow the discussions in later sections for how to configure your VAST2 deployment.

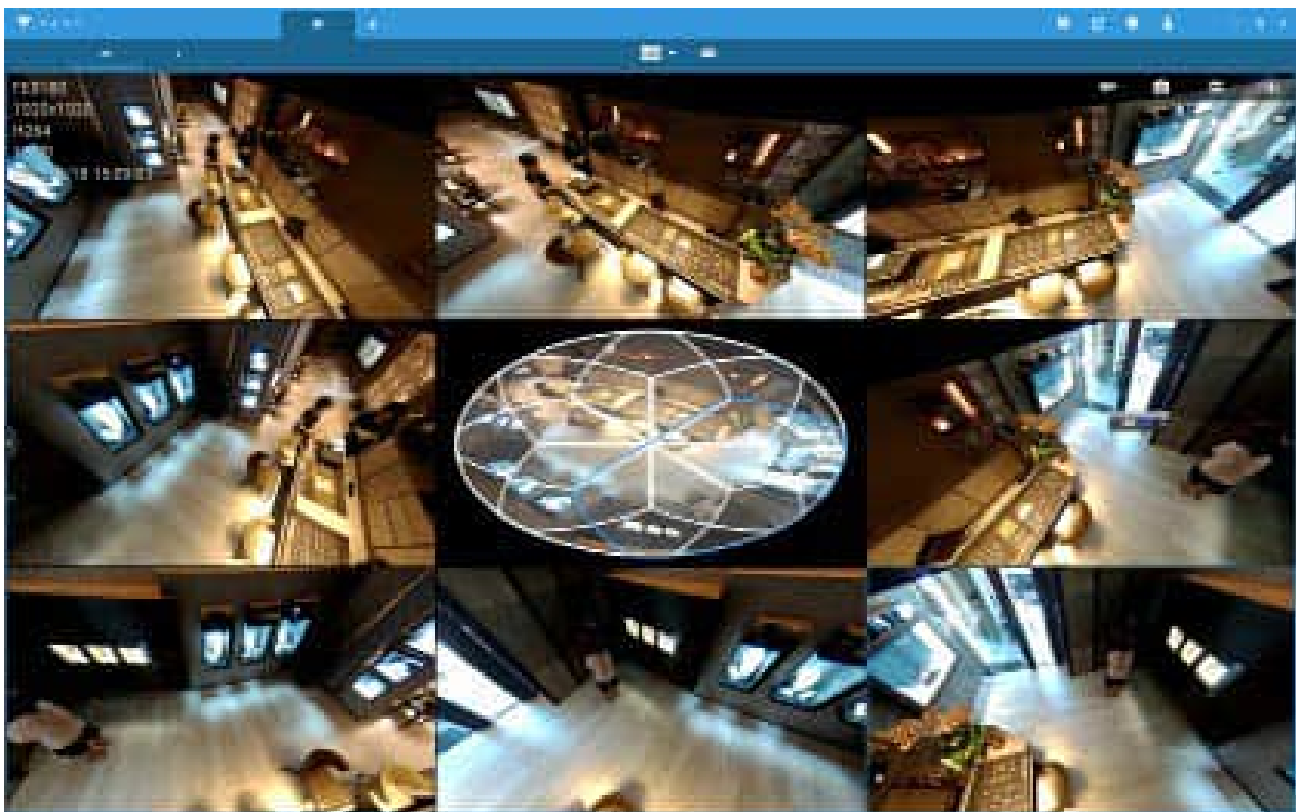

 **NOTE:**

1. Cameras and the NVR must reside in the same subnet. Otherwise, the NVR will not be able to recruit them into a recording configuration.
2. It is recommended all network cameras use static IPs. If you let a DHCP server assign IPs to these cameras, IPs may be changed later and the NVR may not recognize them.

If preferred, change the language of UI text using the Language shortcut on the desktop.



RAID Basics



IMPORTANT:

For a RAID volume configuration, it is recommended you use hard drives of the same model featuring the same capacity and rotation speed. It is also preferred that these drives are running the same version of firmware.

A Redundant Array of Independent Disks is an array, or group, of multiple independent physical drives that provide high performance and fault tolerance. A RAID drive group improves I/O performance and reliability. The RAID drive group appears to the host computer as a single storage volume or as multiple virtual units. An I/O transaction is expedited because several drives can be accessed simultaneously.

A RAID drive group improves data storage reliability and fault tolerance compared to single drive storage. Data loss resulting from a drive failure can be prevented by reconstructing missing data from the remaining drives. The benefits of RAID come from the improvement of I/O performance and the increased reliability.

What are the Virtual drives?

Virtual drives are drive groups that are available to the operating systems. The storage space in a virtual drive comes from all the members in the drive group.

The RAID functions available for virtual drives include:

- Hot spare drives.
- Drive group and virtual drive configurations.
- Initializing one or more virtual drives.
- Individual access to controllers, virtual drives, and disk drives.
- Failed drive rebuild.
- Verification of redundancy data in virtual drives using RAID levels 1, 5, 6, 10, 50, and 60.
- Reconstructing virtual drives after the RAID levels or adding a drive to a drive group.
- Independently selecting a host controller to work for.

RAID configuration components

- Drive group: a group of physical drives. These drives will be managed in partitions known as virtual drives.
- Virtual drive: a partition in a drive group made of contiguous data segments from the individual disk drives. A virtual drive can consist of the following components:
 - An entire drive group.
 - More than one entire drive group.
 - A part of drive group.
 - Parts of more than one drive group.
 - A combination of any two of the conditions above.

RAID Fault Tolerance

RAID Level	Number of Tolerable Drive Failures
0	No fault tolerance
1	1, each drive group
5	1
6	2
10	multiple, as long as each failure is in a separate drive group
50	1 in each drive group
60	2 in each drive group

For example, if disk failure occurs in different drive groups, a RAID10 configuration can tolerate multiple drive failures. In each RAID1 drive group, data is mirrored to a counterpart disk drive. Data remains intact if one disk drive should fail in each drive group.

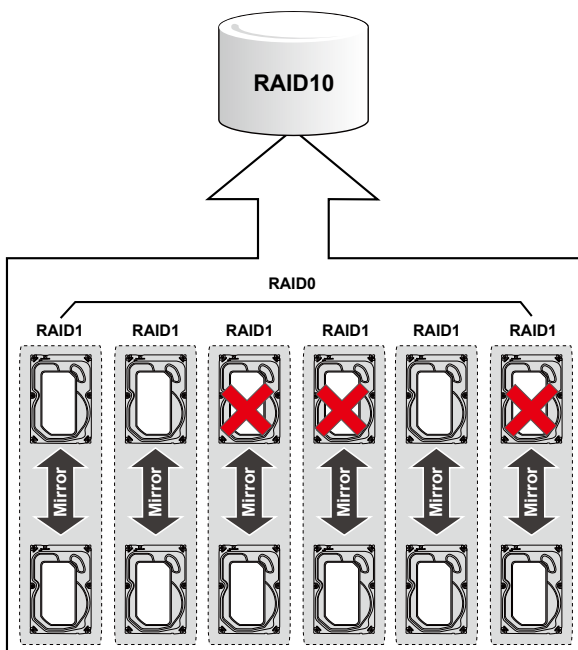

Consistency Check

The consistency check operation verifies the correctness of the data in virtual drives that use RAID levels 1, 5, 6, 10, 50, and 60. RAID0 does not provide data redundancy. In a system with parity, check consistency means calculating the data on one drive and comparing the results to the contents of the parity drive.

Background Initialization

Background initialization is a check for media errors on the drives when you create a virtual drive. It is an automatic operation that starts five minutes after you create a virtual drive. This check ensures that striped data segments are the same on all of the drives in the drive group.

Background initialization is similar to a consistency check. The difference between the two is that a background initialization is forced on new virtual drives and a consistency check is not.

New RAID 5 virtual drives and new RAID 6 virtual drives require a minimum number of drives for a background initialization to start. If fewer drives exist, the background initialization does not start. The background initialization needs to be started manually. The following number of drives are required:

- New RAID 5 virtual drives must have at least five drives for background initialization to start.
- New RAID 6 virtual drives must have at least seven drives for background initialization to start.

The default and recommended background initialization rate is 30 percent. Before you change the rebuild rate, you must stop the background initialization or the rate change will not affect the background initialization rate. After you stop background initialization and change the rebuild rate, the rate change takes effect when you restart background initialization.

Disk Striping

Disk striping lets you write data across multiple drives instead of just one drive. Disk striping involves partitioning each drive storage space into stripes that can vary in size from a minimum of 64 KB to 1 MB for MegaRAID controllers and 64 KB for Integrated MegaRAID controllers. The LSI SAS2108 controller allows stripe size from 8 KB to 1 MB. These stripes are interleaved in a repeated sequential manner. The combined storage space is composed of stripes from each drive. It is recommended that you keep stripe sizes the same across RAID drive groups.

For example, in a four-disk system using only disk striping (used in RAID level 0), segment 1 is written to disk 1, segment 2 is written to disk 2, and so on. Disk striping enhances performance because multiple drives are accessed simultaneously, but disk striping does not provide data redundancy.

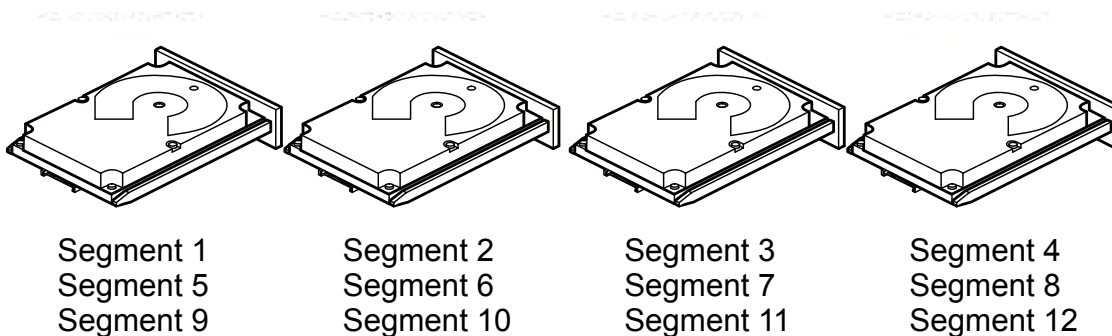

Stripe Width

Stripe width is the number of drives involved in a drive group where striping is implemented. For example, a four-disk drive group with disk striping has a stripe width of four.

Stripe Size

The stripe size is the length of the interleaved data segments that the RAID controller writes across multiple drives, not including parity drives. For example, consider a stripe that contains 1 MB of drive space and has 64 KB of data residing on each drive in the stripe. In this case, the stripe size is 1 MB and the strip size is 64 KB.

Strip Size

The strip size is the portion of a stripe that resides on a single drive.

Disk Mirroring

With disk mirroring (used in RAID 1 and RAID 10), data written to one drive is simultaneously written to another drive. The primary advantage of disk mirroring is that it provides 100 percent data redundancy. Because the contents of the disk are completely written to a second disk, data is not lost if one disk fails. In addition, both drives contain the same data at all times, so either disk can act as the operational disk. If one disk fails, the contents of the other disk can run the system and reconstruct the failed disk.

Disk mirroring provides 100 percent redundancy, but it is expensive because each drive in the system must be duplicated. The following figure shows an example of disk mirroring.

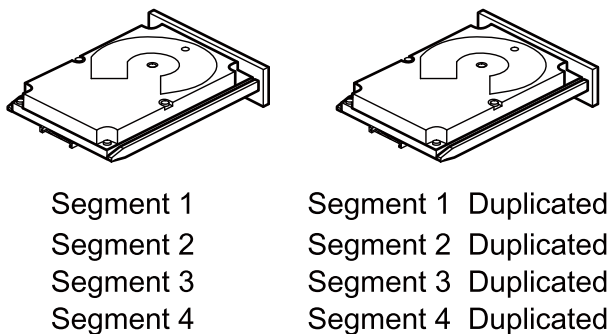

3_01080-00

Parity

Parity generates a set of redundancy data from two or more parent data sets. The redundancy data can be used to reconstruct one of the parent data sets in the event of a drive failure. Parity data does not fully duplicate the parent data sets, but parity generation can slow the write process. In a RAID drive group, this method is applied to entire drives or stripes across all of the drives in a drive group. The types of parity are described in the following table.

Parity Type	Description
Dedicated	The parity data on two or more drives is stored on an additional disk.
Distributed	The parity data is distributed across more than one drive in the system.

A RAID 5 drive group combines distributed parity with disk striping. If a single drive fails, it can be rebuilt from the parity and the data on the remaining drives. An example of a RAID 5 drive group is shown in the following figure. A RAID 5 drive group uses parity to provide redundancy for one drive failure without duplicating the contents of entire drives. A RAID 6 drive group also uses distributed parity and disk striping, but adds a second set of parity data so that it can survive up to two drive failures.

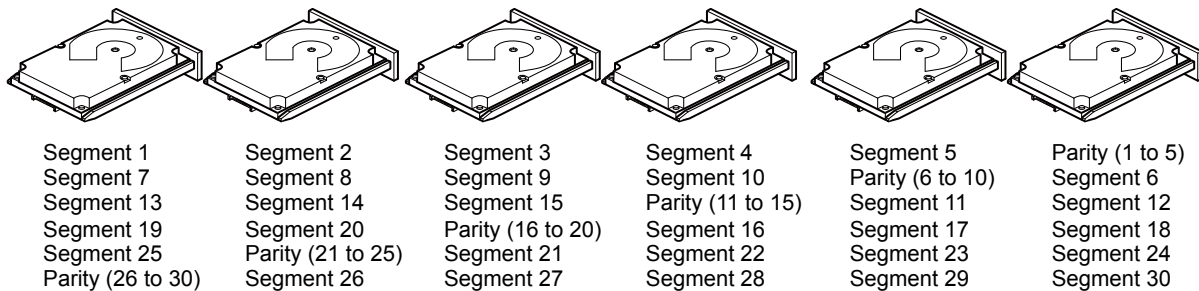

Disk Spanning

Disk spanning allows multiple drives to function like one big drive. Spanning overcomes lack of disk space and simplifies storage management by combining existing resources or adding relatively inexpensive resources. For example, four 20-GB drives can be combined to appear to the operating system as a single 80-GB drive. Spanning alone does not provide reliability or performance enhancements. Spanned virtual drives must have the same stripe size and must be contiguous. In the following figure, RAID 1 drive groups are turned into a RAID 10 drive group.

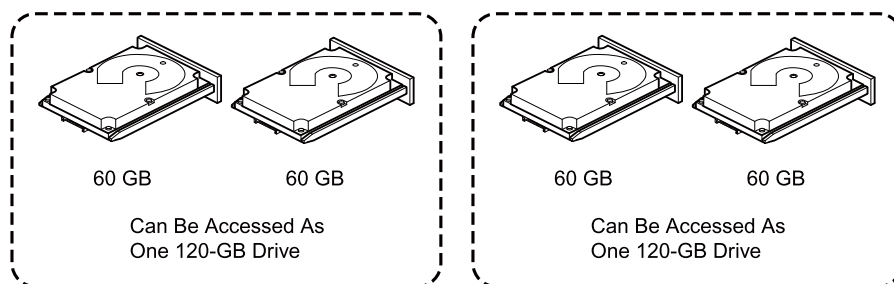

Spanning two contiguous RAID 0 virtual drives does not produce a new RAID level or add fault tolerance. It does increase the capacity of the virtual drive and improves performance by doubling the number of spindles.

Spanning for RAID 00, RAID 10, RAID 50, and RAID 60 Drive Groups

The following table describes how to configure RAID 00, RAID 10, RAID 50, and RAID 60 drive groups by spanning. The virtual drives must have the same stripe size and the maximum number of spans is 8. The full drive capacity is used when you span virtual drives; you cannot specify a smaller drive capacity.

Level	Description
00	Configure a RAID 00 by spanning two or more contiguous RAID 0 virtual drives, up to the maximum number of supported devices for the controller.
10	Configure RAID 10 by spanning two or more contiguous RAID 1 virtual drives, up to the maximum number of supported devices for the controller. A RAID 10 drive group supports a maximum of 8 spans. You must use an even number of drives in each RAID virtual drive in the span. The RAID 1 virtual drives must have the same stripe size.
50	Configure a RAID 50 drive group by spanning two or more contiguous RAID 5 virtual drives. The RAID 5 virtual drives must have the same stripe size.
60	Configure a RAID 60 drive group by spanning two or more contiguous RAID 6 virtual drives. The RAID 6 virtual drives must have the same stripe size.

Hot Spares

A hot spare is an extra, unused drive that is part of the disk subsystem. It is usually in Standby mode, ready for service if a drive fails. Hot spares let you replace failed drives without system shutdown or user intervention. The MegaRAID SAS RAID controllers can implement automatic and transparent rebuilds of failed drives using hot spare drives, which provide a high degree of fault tolerance and zero downtime.

The RAID management software lets you specify drives as hot spares. When a hot spare is needed, the RAID controller assigns the hot spare that has a capacity closest to and at least as great as that of the failed drive to take the place of the failed drive. The failed drive is removed from the virtual drive and marked ready awaiting removal after the rebuild to a hot spare begins. You can make hot spares of the drives that are not in a RAID virtual drive.

You can use the RAID management software to designate the hot spare to have enclosure affinity, which means that if drive failures are present on a split backplane configuration, the hot spare will be used first on the backplane side in which it resides. If the hot spare is designated as having enclosure affinity, it tries to rebuild any failed drives on the backplane in which it resides before rebuilding any other drives on other backplanes.

The hot spare can be of two types:

- Global hot spare
- Dedicated hot spare

Global Hot Spare

Use a global hot spare drive to replace any failed drive in a redundant drive group as long as its capacity is equal to or larger than the coerced capacity of the failed drive. A global hot spare defined on any channel should be available to replace a failed drive on both channels.

Dedicated Hot Spare

Use a dedicated hot spare to replace a failed drive only in a selected drive group. One or more drives can be designated as a member of a spare drive pool. The most suitable drive from the pool is selected for failover. A dedicated hot spare is used before one from the global hot spare pool.

Hot spare drives can be located on any RAID channel. Standby hot spares (not being used in RAID drive group) are polled every 60 seconds at a minimum, and their status made available in the drive group management software. RAID controllers offer the ability to rebuild with a disk that is in a system but not initially set to be a hot spare.

Observe the following parameters when using hot spares:

- Hot spares are used only in drive groups with redundancy: RAID levels 1, 5, 6, 10, 50, and 60.
- A hot spare connected to a specific RAID controller can be used to rebuild a drive that is connected only to the same controller.
- You must assign the hot spare to one or more drives through the controller BIOS or use drive group management software to place it in the hot spare pool.
- A hot spare must have free space equal to or greater than the drive it replaces. For example, to replace a 500-GB drive, the hot spare must be 500-GB or larger.

Disk Rebuilds

When a drive in a RAID drive group fails, you can rebuild the drive by re-creating the data that was stored on the drive before it failed. The RAID controller re-creates the data using the data stored on the other drives in the drive group. Rebuilding can be performed only in drive groups with data redundancy, which includes RAID 1, 5, 6, 10, 50, and 60 drive groups.

The RAID controller uses hot spares to rebuild failed drives automatically and transparently, at user-defined rebuild rates. If a hot spare is available, the Rebuild operation can start automatically when a drive fails. If a hot spare is not available, the failed drive must be replaced with a new drive so that the data on the failed drive can be rebuilt.

The failed drive is removed from the virtual drive and marked ready awaiting removal when the Rebuild operation to a hot spare begins. If the system goes down during a Rebuild operation, the RAID controller automatically resumes the rebuild after the system reboots.



NOTE:

When the Rebuild operation to a hot spare begins, the failed drive is often removed from the virtual drive before management applications detect the failed drive. When this removal occurs, the event logs show the drive rebuilding to the hot spare without showing the failed drive. The formerly failed drive will be marked as ready after a Rebuild operation begins to a hot spare. If a source drive fails during a rebuild to a hot spare, the Rebuild operation fails, and the failed source drive is marked as offline. In addition, the rebuilding hot spare drive is changed back to a hot spare. After a Rebuild operation fails because of a source drive failure, the dedicated hot spare is still dedicated and assigned to the correct drive group, and the global hot spare is still global.

An automatic drive Rebuild operation will not start if you replace a drive during a RAID-level migration. The Rebuild operation must be started manually after the expansion or migration procedure is complete. (RAID-level migration changes a virtual drive from one RAID level to another.)

Hot Swap

A hot swap is the manual replacement of a defective drive unit while the computer is still running. When a new drive has been installed, a Rebuild operation occurs automatically if these situation occurs:

- The newly inserted drive is the same capacity as or larger than the failed drive.
- The newly inserted drive is placed in the same drive bay as the failed drive it is replacing.

The RAID controller can be configured to detect the new drives and rebuild the contents of the drive automatically.

Drive States

A drive state is a property indicating the status of the drive. The drive states are described in the following table.

Parity Type	Description
Online	A drive that can be accessed by the RAID controller and is part of the virtual drive.
Unconfigured Good	A drive that is functioning normally but is not configured as a part of a virtual drive or as a hot spare.
Hot Spare	A drive that is powered up and ready for use as a spare in case an online drive fails.
Failed	A drive that was originally configured as Online or Hot Spare, but on which the firmware detects an unrecoverable error.
Rebuild	A drive to which data is being written to restore full redundancy for a virtual drive.
Unconfigured Bad	A drive on which the firmware detects an unrecoverable error; the drive was Unconfigured Good or the drive could not be initialized.
Missing	A drive that was Online but which has been removed from its location.
Offline	A drive that is part of a virtual drive but which has invalid data as far as the RAID configuration is concerned.
Shield State	An interim state of physical drive for diagnostic operations.
Copyback	A drive that has replaced the failed drive in the RAID configuration.

Virtual Drive States

The virtual drive states are described in the following table.

Parity Type	Description
Online	The virtual drive operating condition is good. All configured drives are online.
Degraded	The virtual drive operating condition is not optimal. One of the configured drives has failed or is offline.
Partial Degraded	The operating condition in a RAID 6 virtual drive is not optimal. One of the configured drives has failed or is offline. A RAID 6 drive group can tolerate up to two drive failures.
Failed	The virtual drive has failed.
Offline	The virtual drive is not available to the RAID controller.

Beep Codes

An alarm sounds on the MegaRAID controller when a virtual drive changes from an optimal state to another state, when a hot spare rebuilds, and for test purposes.

Parity Type	Virtual Drive State	Beep Code
RAID 0 virtual drive loses a virtual drive	Offline	3 seconds on and 1 second off
RAID 1 virtual drive loses a mirror drive	Degraded	1 second on and 1 second off
RAID 1 virtual drive loses both drives	Offline	3 seconds on and 1 second off
RAID 5 virtual drive loses one drive	Degraded	1 second on and 1 second off
RAID 5 virtual drive loses two or more drives	Offline	3 seconds on and 1 second off
RAID 6 virtual drive loses one drive	Partially degraded	1 second on and 1 second off
RAID 6 virtual drive loses two drives	Degraded	1 second on and 1 second off
RAID 6 virtual drive loses more than two drives	Offline	3 seconds on and 1 second off
A hot spare completes the Rebuild process and is brought into a drive group	B/A	1 second on and 3 seconds off
A copy back occurs after a Rebuild operation completes	Optimal	1 second on and 3 seconds off

RAID Levels

The RAID controller supports RAID levels 0, 00, 1, 5, 6, 10, 50, and 60. The supported RAID levels are summarized in the following section.

In addition, the RAID controller supports independent drives (configured as RAID 0 and RAID 00 drive groups) The following sections describe the RAID levels in detail.

Summary of RAID Levels

A RAID 0 drive group uses striping to provide high data throughput, especially for large files in an environment that does not require fault tolerance.

A RAID 1 drive group uses mirroring so that data written to one drive is simultaneously written to another drive. The RAID 1 drive group is good for small databases or other applications that require small capacity but complete data redundancy.

A RAID 5 drive group uses disk striping and parity data across all drives (distributed parity) to provide high data throughput, especially for small random access. A RAID 6 drive group uses distributed parity, with two independent parity blocks per stripe, and disk striping.

A RAID 6 virtual drive can survive the loss of any two drives without losing data. A RAID 6 drive group, which requires a minimum of three drives, is similar to a RAID 5 drive group. Blocks of data and parity information are written across all drives. The parity information is used to recover the data if one or two drives fail in the drive group.

A RAID 00 drive group is a spanned drive group that creates a striped set from a series of RAID 0 drive groups. A RAID 10 drive group, a combination of RAID 0 and RAID 1 drive groups, consists of striped data across mirrored spans.

A RAID 10 drive group is a spanned drive group that creates a striped set from a series of mirrored drives. A RAID 10 drive group allows a maximum of 8 spans. You must use an even number of drives in each RAID virtual drive in the span. The RAID 1 virtual drives must have the same stripe size. A RAID 10 drive group provides high data throughput and complete data redundancy but uses a larger number of spans.

A RAID 50 drive group, a combination of RAID 0 and RAID 5 drive groups, uses distributed parity and disk striping. A RAID 50 drive group is a spanned drive group in which data is striped across multiple RAID 5 drive groups. A RAID 50 drive group works best with data that requires high reliability, high request rates, high data transfers, and medium-to-large capacity.

**NOTE**

Having virtual drives of different RAID levels, such as RAID Level 0 and RAID Level 5, in the same drive group is not allowed. For example, if an existing RAID 5 virtual drive is created out of partial space in an array, the next virtual drive in the array has to be RAID Level 5 only.

A RAID 60 drive group, a combination of RAID level 0 and RAID Level 6, uses distributed parity, with two independent parity blocks per stripe in each RAID set, and disk striping. A RAID 60 virtual drive can survive the loss of two drives in each of the RAID 6 sets without losing data. A RAID 60 drive group works best with data that requires high reliability, high request rates, high data transfers, and medium-to-large capacity.

**NOTE**

The MegaSR controller supports the standard RAID levels – RAID 0, RAID 1, RAID 5, and RAID 10. The MegaSR controller comes in two variants, SCU and AHCI, both supporting a maximum of eight physical drives. A maximum of eight virtual drives can be created (using RAID 0, RAID 1, RAID 5, and RAID 10 only) and controlled by the MegaSR controller. One virtual drive can be created on an array (a maximum of eight if no other virtual drives are already created on the MegaSR controller), or you can create eight arrays with one virtual drive each. However, on a RAID 10 drive group, you can create only one virtual drive on a particular array.

RAID 0 Drive Groups

A RAID 0 drive group provides disk striping across all drives in the RAID drive group. A RAID0 drive group does not provide any data redundancy, but the RAID 0 drive group offers the best performance of any RAID level. The RAID 0 drive group breaks up data into smaller segments, and then stripes the data segments across each drive in the drive group. The size of each data segment is determined by the stripe size. A RAID 0 drive group offers high bandwidth.

By breaking up a large file into smaller segments, the RAID controller can use both SAS drives and SATA drives to read or write the file faster. A RAID 0 drive group involves no parity calculations to complicate the write operation. This situation makes the RAID 0 drive group ideal for applications that require high bandwidth but do not require fault tolerance. The following table provides an overview of the RAID 0 drive group. The following figure provides a graphic example of a RAID 0 drive group.



NOTE

RAID level 0 is not fault tolerant. If a drive in a RAID 0 drive group fails, the entire virtual drive (all drives associated with the virtual drive) fails.

Uses	Provides high data throughput, especially for large files. Any environment that does not require fault tolerance.
Strong points	Provides increased data throughput for large files. No capacity loss penalty for parity.
Weak points	Does not provide fault tolerance or high bandwidth. All data is lost if any drive fails.
Drives	1 to 32

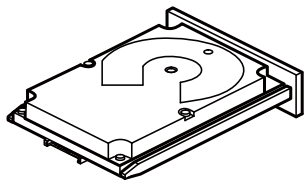

Segment 1
Segment 3
Segment 5
Segment 7

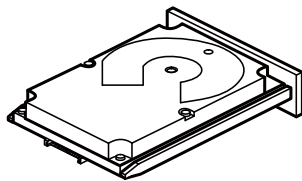

Segment 2
Segment 4
Segment 6
Segment 8

RAID 1 Drive Groups

In RAID 1 drive groups, the RAID controller duplicates all data from one drive to a second drive in the drive group. A RAID 1 drive group supports an even number of drives from 2 through 32 in a single span. The RAID1 drive group provides complete data redundancy, but at the cost of doubling the required data storage capacity. The following table provides an overview of a RAID1 drive group. The following figure provides a graphic example of a RAID1 drive group.

Uses	Use RAID 1 drive groups for small databases or any other environment that requires fault tolerance but small capacity.
Strong points	Provides complete data redundancy.A RAID 1 drive group is ideal for any application that requires fault tolerance and minimal capacity.
Weak points	Requires twice as many drives. Performance is impaired during drive rebuilds.
Drives	2 through 32 (must be an even number of drives)

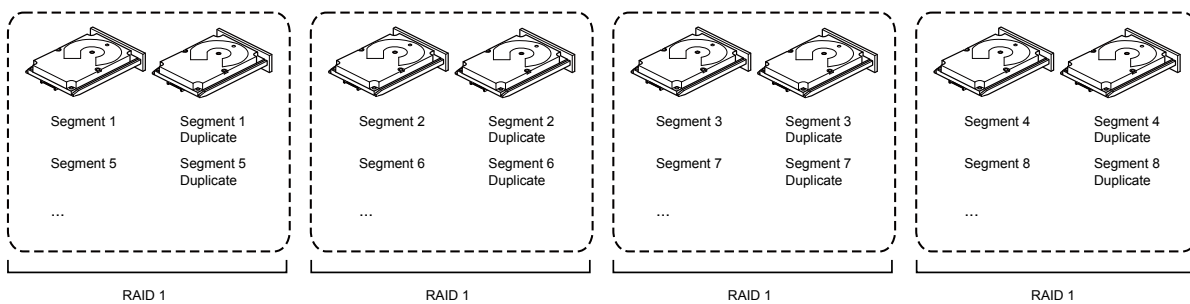

RAID 5 Drive Groups

A RAID 5 drive group includes disk striping at the block level and parity. Parity is the data's property of being odd or even, and parity checking is used to detect errors in the data. In RAID5 drive groups, the parity information is written to all drives. A RAID5 drive group is best suited for networks that perform a lot of small input/output (I/O) transactions simultaneously. The following table provides an overview of a RAID5 drive group. The following figure provides a graphic example of a RAID5 drive group.

Uses	Provides high data throughput, especially for large files. Use RAID 5 drive groups for transaction processing applications because each drive can read and write independently. If a drive fails, the RAID controller uses the parity drive to re-create all missing information. Use also for online customer service that requires fault tolerance. Use for any application that has high read request rates but random write request rates.
Strong points	Provides data redundancy, high read rates, and good performance in most environments. Provides redundancy with lowest loss of capacity.
Weak points	Not well suited to tasks requiring lots of small writes or small block write operations. Suffers more impact if no cache is used. Drive performance is reduced if a drive is being rebuilt. Environments with few processes do not perform as well because the RAID drive group overhead is not offset by the performance gains in handling simultaneous processes.
Drives	3 through 32

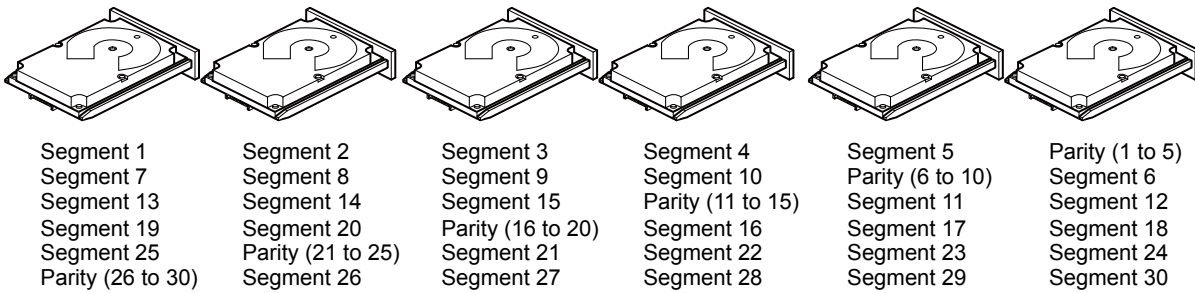

RAID 6 Drive Groups

A RAID6 drive group is similar to a RAID5 drive group (disk striping and parity), except that instead of one parity block per stripe, there are two. With two independent parity blocks, A RAID6 drive group can survive the loss of any two drives in a virtual drive without losing data. A RAID6 drive group provides a high level of data protection through the use of a second parity block in each stripe. Use a RAID6 drive group for data that requires a very high level of protection from loss.

In the case of a failure of one drive or two drives in a virtual drive, the RAID controller uses the parity blocks to re-create all of the missing information. If two drives in a RAID6 virtual drive fail, two drive rebuilds are required, one for each drive. These rebuilds do not occur at the same time. The controller rebuilds one failed drive, and then the other failed drive. The following table provides an overview of a RAID6 drive group.

Uses	Use for any application that has high read request rates but low random or small block write rates.
Strong points	Provides data redundancy, high read rates, and good performance in most environments. Can survive the loss of two drives or the loss of a drive while another drive is being rebuilt. Provides the highest level of protection against drive failures of all of the RAID levels. Performance is similar to that of a RAID5 drive group.
Weak points	Not well-suited to tasks requiring a lot of small and/or random write operations. A RAID 6 virtual drive must generate two sets of parity data for each write operation, which results in a significant decrease in performance during write operations. Drive performance is reduced during a drive Rebuild operation. Environments with few processes do not perform as well because the RAID overhead is not offset by the performance gains in handling simultaneous processes. A RAID6 drive group costs more because of the extra capacity required by using two parity blocks per stripe.
Drives	3 through 32

The following figure shows a RAID6 drive group data layout. The second set of parity drives is denoted by Q. The P drives follow the RAID5 drive group parity scheme.

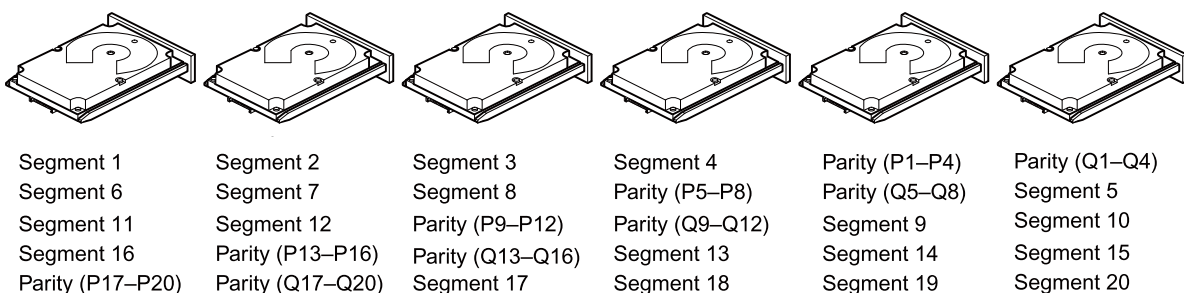

Note: Parity is distributed across all drives in the drive group.

RAID 00 Drive Groups

A RAID 00 drive group is a spanned drive group that creates a striped set from a series of RAID0 drive groups. A RAID00 drive group does not provide any data redundancy, but, along with the RAID0 drive group, does offer the best performance of any RAID level. A RAID00 drive group breaks up data into smaller segments and then stripes the data segments across each drive in the drive groups. The size of each data segment is determined by the stripe size. A RAID00 drive group offers high bandwidth.

 **NOTE**

RAID level 00 is not fault tolerant. If a drive in a RAID 0 drive group fails, the entire virtual drive (all drives associated with the virtual drive) fails.

By breaking up a large file into smaller segments, the controller can use both SAS drives and SATA drives to read or write the file faster. A RAID00 drive group involves no parity calculations to complicate the write operation. This situation makes the RAID00 drive group ideal for applications that require high bandwidth but do not require fault tolerance. The following table provides an overview of the RAID00 drive group. The following figure provides a graphic example of a RAID 00 drive group.

Uses	Provides high data throughput, especially for large files. Any environment that does not require fault tolerance.
Strong points	Provides increased data throughput for large files. No capacity loss penalty for parity.
Weak points	Does not provide fault tolerance or high bandwidth. All data lost if any drive fails.
Drives	2 through 256

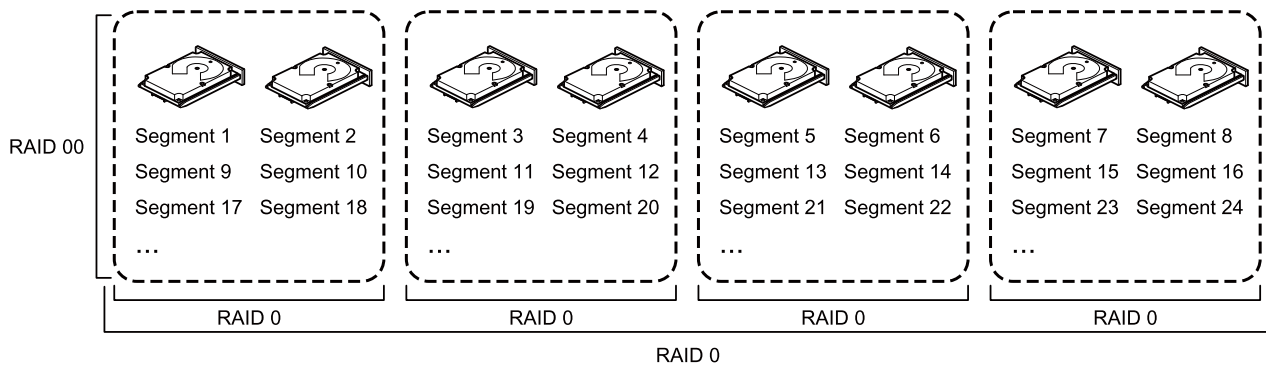

RAID 10

A RAID10 drive group is a combination of RAID level 0 and RAID level 1, and it consists of stripes across mirrored drives. A RAID10 drive group breaks up data into smaller blocks and then mirrors the blocks of data to each RAID1 drive group. The first RAID1 drive in each drive group then duplicates its data to the second drive. The size of each block is determined by the stripe size parameter, which is set during the creation of the RAID set. The RAID 1 virtual drives must have the same stripe size.

Spanning is used because one virtual drive is defined across more than one drive group. Virtual drives defined across multiple RAIDlevel 1 drive groups are referred to as RAID level 10, (1+0). Data is striped across drive groups to increase performance by enabling access to multiple drive groups simultaneously.

Each spanned RAID 10 virtual drive can tolerate multiple drive failures, as long as each failure is in a separate drive group. If drive failures occur, less than total drive capacity is available. Configure RAID 10 drive groups by spanning two contiguous RAID1 virtual drives, up to the maximum number of supported devices for the controller. A RAID10 drive group supports a maximum of 8spans, with a maximum of 32drives per span. You must use an even number of drives in each RAID10 virtual drive in the span.



NOTE

Other factors, such as the type of controller, can restrict the number of drives supported by RAID 10 virtual drives.

The following table provides an overview of a RAID10 drive group.

Uses	Appropriate when used with data storage that needs 100 percent redundancy of mirrored drive groups and that also needs the enhanced I/O performance of RAID 0 (striped drive groups.) A RAID10 drive group works well for medium-sized databases or any environment that requires a higher degree of fault tolerance and moderate-to-medium capacity.
Strong points	Provides both high data transfer rates and complete data redundancy.
Weak points	Requires twice as many drives as all other RAID levels except in RAID 1 drive groups.
Drives	4 to 32 in multiples of 4 — The maximum number of drives supported by the controller (using an even number of drives in each RAID 10 virtual drive in the span).

In the following figure, virtual drive 0 is created by distributing data across four drive groups (drive groups 0 through3).

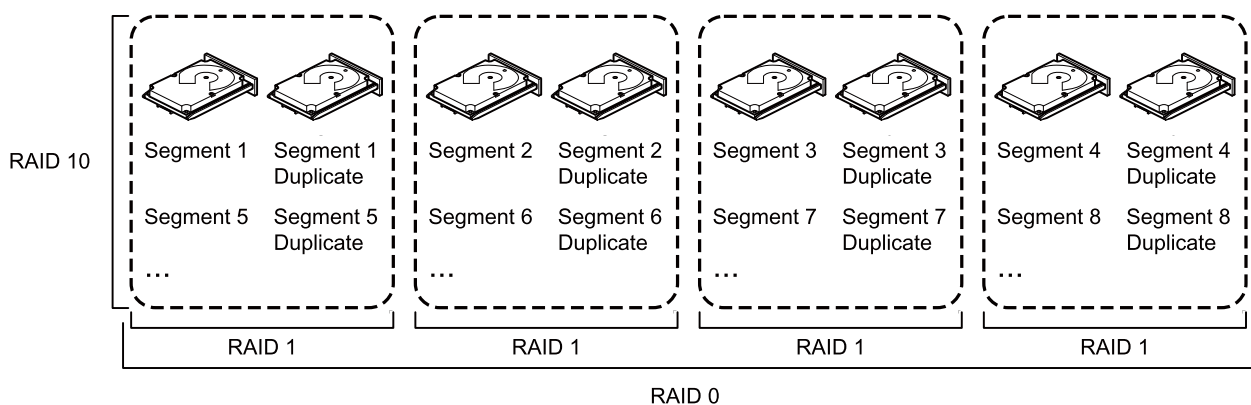

RAID 50

A RAID50 drive group provides the features of both RAID0 and RAID5 drive groups. A RAID50 drive group includes both distributed parity and drive striping across multiple drive groups. A RAID50 drive group is best implemented on two RAID5 drive groups with data striped across both drive groups.

A RAID50 drive group breaks up data into smaller blocks and then stripes the blocks of data to each RAID5 disk set. A RAID5 drive group breaks up data into smaller blocks, calculates parity by performing an exclusive OR operation on the blocks, and then performs write operations to the blocks of data and parity to each drive in the drive group. The size of each block is determined by the stripe size parameter, which is set during the creation of the RAID set.

A RAID level 50 drive group can support up to eight spans and tolerate up to eight drive failures, though less than total drive capacity is available. Though multiple drive failures can be tolerated, only one drive failure can be tolerated in each RAID 5 level drive group.

The following table provides an overview of a RAID50 drive group.

Uses	Appropriate when used with data that requires high reliability, high request rates, high data transfer, and medium-to-large capacity. Also used when a virtual drive of greater than 32 drives is needed.
Strong points	Provides high data throughput, data redundancy, and very good performance.
Weak points	Requires two times to eight times as many parity drives as a RAID 5 drive group.
Drives	Eight spans of RAID 5 drive groups that contain 3 to 32 drives each (limited by the maximum number of devices supported by the controller)

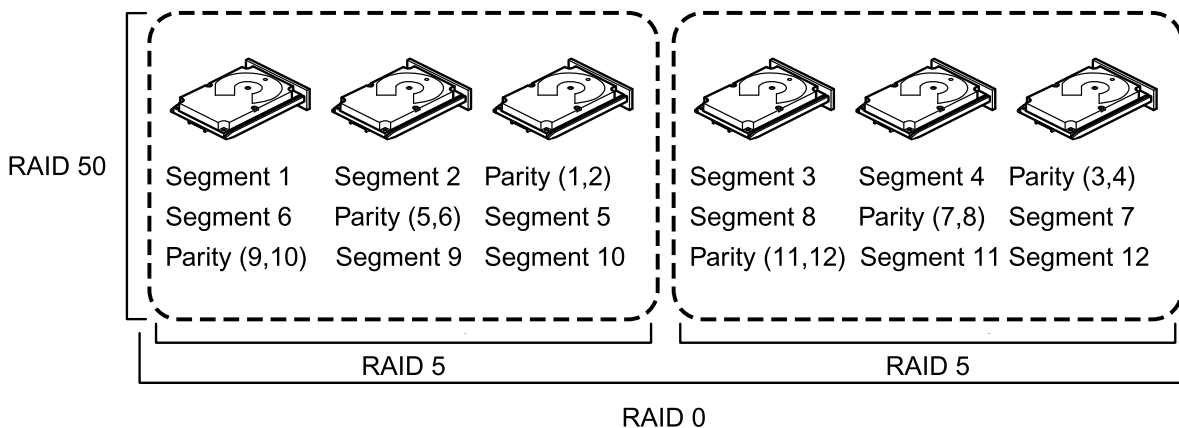

RAID 60

A RAID 60 drive group provides the features of both RAID 0 and RAID 6 drive groups, and includes both parity and disk striping across multiple drive groups. A RAID6 drive group supports two independent parity blocks per stripe. A RAID 60 virtual drive can survive the loss of two drives in each of the RAID6 drive group sets without losing data. A RAID60 drive group is best implemented on two RAID6 drive groups with data striped across both drive groups.

A RAID60 drive group breaks up data into smaller blocks and then stripes the blocks of data to each RAID6 disk set. A RAID6 drive group breaks up data into smaller blocks, calculates parity by performing an exclusive-OR operation on the blocks, and then performs write operations to the blocks of data and writes the parity to each drive in the drive group. The size of each block is determined by the stripe size parameter, which is set during the creation of the RAID set.

A RAID60 drive group can support up to 8 spans and tolerate up to 16 drive failures, though less than total drive capacity is available. Two drive failures can be tolerated in each RAID 6 level drive group.

Uses	<p>Provides a high level of data protection through the use of a second parity block in each stripe. Use a RAID60 drive group for data that requires a very high level of protection from loss.</p> <p>In the case of a failure of one drive or two drives in a RAID set in a virtual drive, the RAID controller uses the parity blocks to re-create all of the missing information. If two drives in a RAID 6 set in a RAID60 virtual drive fail, two drive Rebuild operations are required, one for each drive. These Rebuild operations can occur at the same time.</p> <p>Use for online customer service that requires fault tolerance. Use for any application that has high read request rates but low write request rates. Also used when a virtual drive of greater than 32 drives is needed.</p>
Strong points	<p>Provides data redundancy, high read rates, and good performance in most environments. Each RAID6 set can survive the loss of two drives or the loss of a drive while another drive is being rebuilt. Provides the highest level of protection against drive failures of all of the RAID levels.</p>
Weak points	<p>Not well-suited for small block write or random write operations. A RAID 60 virtual drive must generate two sets of parity data for each write operation, which results in a significant decrease in performance during write operations. Drive performance is reduced during a drive Rebuild operation. Environments with few processes do not perform as well because the RAID overhead is not offset by the performance gains in handling simultaneous processes.</p> <p>A RAID6 drive group costs more because of the extra capacity required by using two parity blocks per stripe.</p>
Drives	A minimum of 6.

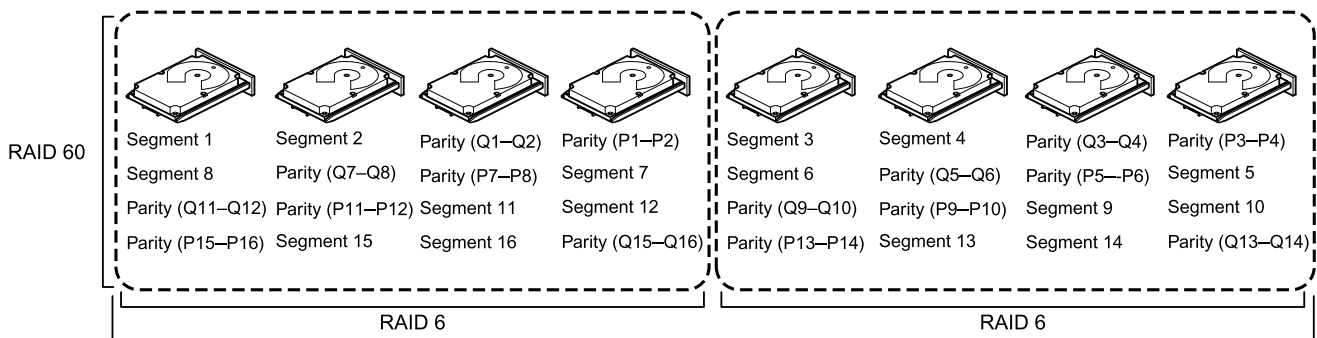

Note: Parity is distributed across all drives in the drive group. RAID 0

Chapter Two VAST2 Software Configuration and Management

Log in

To log in,

1. Enter the server's IP address and TCP port number (3443 as the default). If logging in from the server itself, you can select the Local station checkbox.
2. Enter the credentials for login. The credentials were created during the installation.
3. You can use an existing AD account for login. See page 247 for user management and AD account configuration.
4. Auto login: After you enter the credentials for the first time, the server will not prompt for credentials the next time you start the VAST software.

The screenshot shows the VAST2 login screen. At the top is the VAST2 logo. Below it are three checkboxes: 'Local station' (checked), 'AD account' (unchecked), and 'Auto login' (checked). The 'Local station' checkbox is highlighted with a callout box that says 'Login from the local machine using a loop-back address'. Below the checkboxes are two input fields: the first contains '127.0.0.1' and the second contains '3443'. Below these is a text input field containing 'admin', followed by a password input field with masked characters. A blue 'Log in' button is positioned below the password field. At the bottom of the screen is the VIVOTEK logo. Three callout boxes are present: one pointing to the 'Local station' checkbox, one pointing to the 'AD account' checkbox, and one pointing to the 'Auto login' checkbox. The 'AD account' callout says 'login using an existing AD account'. The 'Auto login' callout says 'Automatically login after the first time you entered the credentials'.

Introducing VAST2

VIVOTEK VAST2 is the professional video / central management software designed for managing all VIVOTEK IP surveillance products with intuitive functions and numerous features. It supports hundreds of cameras and stations in a hierarchical structure of system for monitoring, recording, playback and event trigger management with ease-of-use and efficient control.

VAST2 integrates VIVOTEK network cameras to provide diverse solutions and applications, with the cameras for uninterrupted video recording, Smart Search II, Smart VCA, and Cybersecurity management solution. VAST2 performs remote management with full range of the server & client structure and constitutes a robust system for various applications, such as stores, banking and the public space.

New Features

- Smart Search II
- Event Search: General, Smart VCA, and Trend Micro IoT Security events.
- Alarm management with Smart VCA, Trend Micro IoT Security and new general events.
- Alarm list enhancement: Thumbnail view, Status, and Comment.
- Manually export alarm clips.
- Automatically locks video clips when triggered by alarms.
- Sends HTTP requests to all selected cameras, including those under sub-stations, via one alarm configuration.
- Manually refresh selected devices to obtain the latest VADP configuration settings.
- View cells with embedded E-maps.
- Standalone player improvements for displaying VCA rules/metadata, VIVOTEK MP4/3GP, and drag and play feature.

Key Features

- Multiple monitors support on tabbed windows, configurable as live view, tour, E-map, dashboard, or alarm views.
- Supports Windows Active Directory.
- Automatic Problem Feedback mechanism.
- Add-on solutions: Failover (VAST server redundancy), Transportation, Transaction, and Data Magnet.
- Auto Streaming Size for Clients, saving decode and streaming bandwidth.
- Multiple Fisheye Dewarp modes.
- Customizable Layouts for unique camera types, e.g., corridor or panoramic.

- Supports various view settings: time, bandwidth, codec, VCA rules, etc.
- Bookmarks on the occurrence of video events with Evidence Lock.
- Customized layouts, e.g., a dewarped fisheye view, can also be displayed on standalone player.
- Log / Alarm Search & Export
- System overview Dashboard.
- VAST client on MAC machines.

- New Matrix for Video Wall Solution.
- Counting Solution with the display of VCA/Counting reports from cameras.
- Device Packs for instant support for new cameras.
- Panoramic PTZ Support.
- Cybersecurity support.

* The number of linked devices will depend on the number of licenses you purchased.

* The ability to extend devices is also subject to the network bandwidth and computer performance.

Charged Add-on Features

The following are the charged add-on features. These features will not be available unless you purchase and enable their individual licenses:

Transportation License:

- Users have the need to show their mobile server on the Google map.
- Users can use generic GPS device or VIVOTEK's mobile NVR (w/ a built-in GPS)
- We only support IP-based generic GPS.

POS Implementation:

- We provide the following for POS integration:
 - Live view with transaction data.
 - Playback with transaction data.
 - Search using keyword.
 - Highlights specific product item name.

Failover License (substations):

- We support M x N structure.
- The CMS station will be the main station for controlling and monitoring all of the active and redundant servers.
- The Failover license (substations) needs to be imported on the CMS server.

Failover License (CMS):

- We support 1 x 1 redundancy for the CMS station.
- The failover license (CMS) needs to be imported on a CMS server.

Data Magnet License:

- Data Magnet is used for integration with 3rd party data source. For example, POS data, access control, ATM data, LPR data, etc.
- We provide the following for Data Magnet integration:
 - Map the data to specific cameras.
 - Searching 3rd party data using keywords.
 - Show data with live view.
 - Set up alarms using 3rd party data.
 - Highlight specific keyword or value.

Advanced Feature License:

- Advanced License list:
 - Transportation package: Google map / GPS.
 - POS terminal.
 - Failover (Substations)
 - Failover (CMS)
 - TCP message
 - Data Magnet license.

NOTE:

1. Failover license cannot be used on hardware dongle.
2. The related configuration pages/menus will still be available even the license has not been activated.

Calculation - Transportation Package: Google map + GPS



Single Server (50)

Total no. of cameras: 50
Needs 50 packages.

NOTE: camera normal usage licenses are included.



CMS (50)

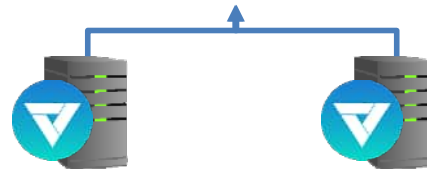

Substation (32)

Substation (46)

Total no. of cameras: $50 + 32 + 46 = 128$
Needs 128 packages.

NOTE: camera normal usage licenses are included.

Calculation - POS License

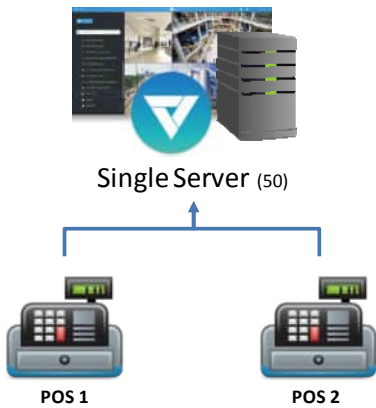

Total no. of POS terminals: 2

Total no. of cameras: 50

Needs 2 POS licenses and 18 [50 - 32(free)] camera licenses.

NOTE: 32 camera channels are for free.

Calculation - Failover License

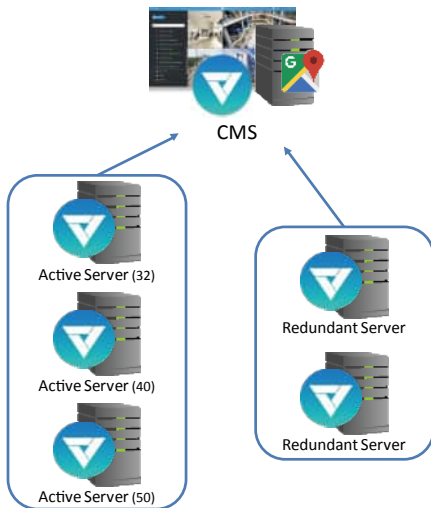

Rule:

No. of channels on the active server hosting the largest no. of cameras x the no. of redundant servers.

Channels on each active server: 32, 40, 50

No. of redundant servers: 2

Total no. of cameras: 122 (32 + 40 + 50)

Needs 100 Failover licenses (50 x 2), and 90 normal camera licenses (122 - 32).

NOTE: 32 camera channels are for free. These licenses do not come with hardware dongle.

Calculation - TCP Message License



Single Server (32)



Alarm list (50)

- 10 TCP messages
- 20 camera motion
- 20 DI trigger

Rule:

The no. of licenses depends on how many alarm rules are using TCP Message as the triggering source.

Total no. of cameras: 32

Total instances of Alarm: 50

The no. of other triggering sources: 40

Needs 10 TCP Message licenses, and 0 for normal camera licenses (32 - 32).

NOTE: 32 camera channels are for free.

Calculation - Data Magnet License



Single Server (50)

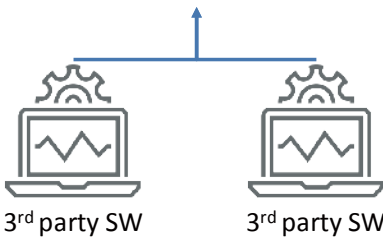

Rule:

The no. of licenses depends on how many Data Magnet sources are implemented.

Total no. of Data Magnet sources: 2

Total no. of cameras: 50

Needs 2 Data Magnet licenses, and 18 normal camera licenses (50 - 32).

NOTE: 32 camera channels are for free.

Installation Option - OpenVPN

NAT-traversal with OpenVPN

You can select the "VAST Server with OpenVPN" option when installing the VAST server. A remote connection from NVR via a 3G/4G/LTE network can be made through an OpenVPN tunnel. When the OpenVPN option is selected, an OpenVPN server will be installed with the VAST server.

HMAC authentication and TLS encryption over an encrypted UDP connection are made effortlessly using the traversal methodology.

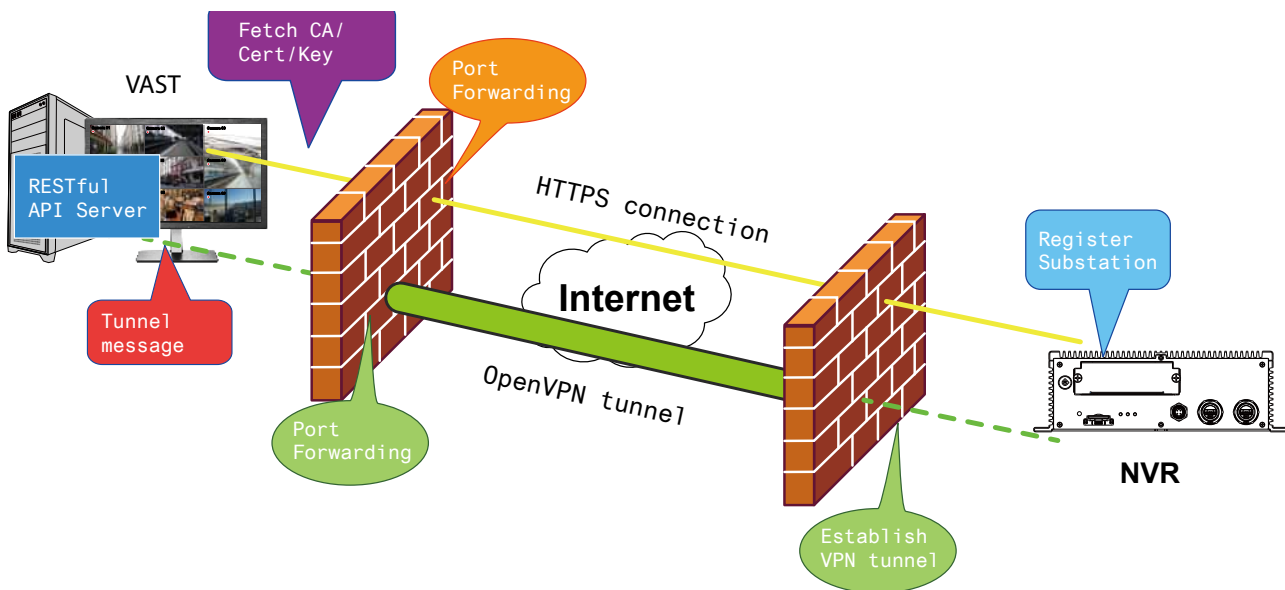

The sample installation screens are shown below:

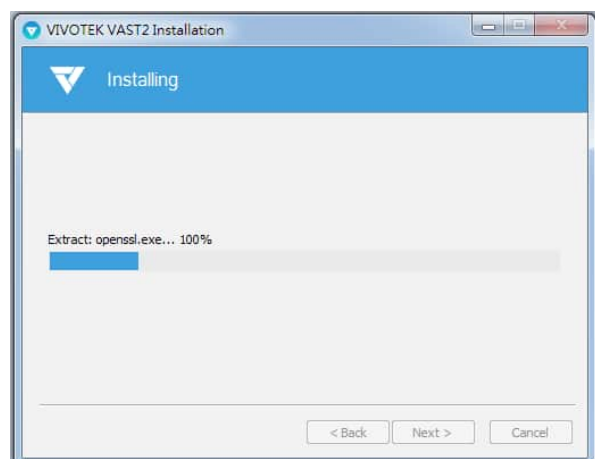
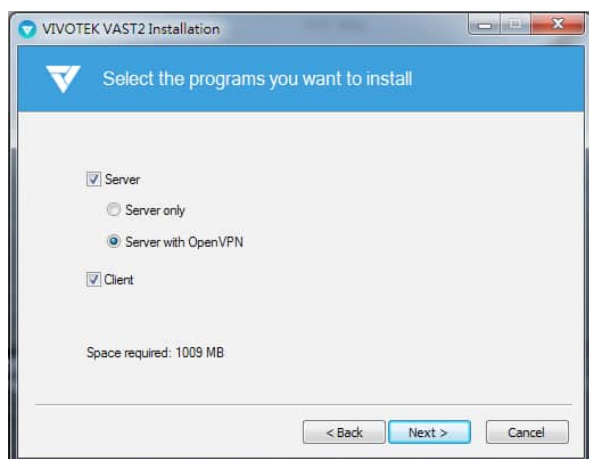

The NVR runs an OpenVPN client that makes remote connection via the RESTful (Representational State Transfer) API (Application Programming Interface) service to a VPN-enabled VAST server running on the remote site. The applicable service port number ranges from 1 to 65534. The default is port #3443. The NVR automatically registers with CA cert key and becomes a VAST sub-station over a VPN tunnel. Once set, the VAST2 can automatically connect the NVR.

Note that on the side of the VAST server making connection via the OpenVPN, the server/client configuration should be properly configured. On the mobile NVR, a proper gateway setting should be made for VPN connection.

For the server configuration, the configuration file is placed in:

[C:\Program Files \(x86\)\VIVOTEK Inc\VAST\Server\OpenVPN\config\server\server.ovpn](C:\Program Files (x86)\VIVOTEK Inc\VAST\Server\OpenVPN\config\server\server.ovpn)

You can edit your VPN IP subnet parameters according to your network configuration. The contents of the editable text file looks like this:

```
port 3939
proto udp
dev tun
ca ca.crt
cert server.crt
key server.key
dh dh.pem
server 10.6.0.0 255.255.0.0
topology subnet
client-to-client
client-config-dir "C:\Program Files (x86)\VIVOTEK Inc\VAST\Server\OpenVPN\ccd"
keepalive 10 30
cipher AES-256-CBC
max-clients 50000
persist-key
persist-tun
status openvpn-status.log
log-append openvpn.log
verb 3
mute 20
sndbuf 262144
rcvbuf 262144
tls-server
```

Note that the NVR and VAST server should have a similar time setting when exchanging certificate information. Otherwise, the mutual handshake authentication process may fail.

Enter the OpenVPN DNS domain name and the credentials on the NVR network service configuration page.

A public IP or domain name must be configured on the VAST server for the access through the Internet. The IP or domain name can contain alpha-numeric characters [0-9][a-z][A-Z][-]. [-] can not be the beginning or the ending character.

Service port

HTTP	<input type="text" value="80"/>
HTTPS	<input type="text" value="443"/>
RTSP	<input type="text" value="554"/>

CMS & iViewer

Allow access

Port	VAST & iViewer	<input type="text" value="3454"/>
	VAST2 (same as HTTPS)	<input type="text" value="443"/>

CMS Set up password for VAST & VAST2 [Reset password](#)

VAST2 remote connection

IP	<input type="text" value="nv9411p.dnset.com"/>
API service port	<input type="text" value="3443"/>
Username (administrator)	<input type="text" value="admin"/>
Account password	<input type="password" value="•"/>





[Apply](#)

Chapter 2-1 Basics: Control and Elements

The basic screen elements of VAST live view, playback, and search pane are shown below:

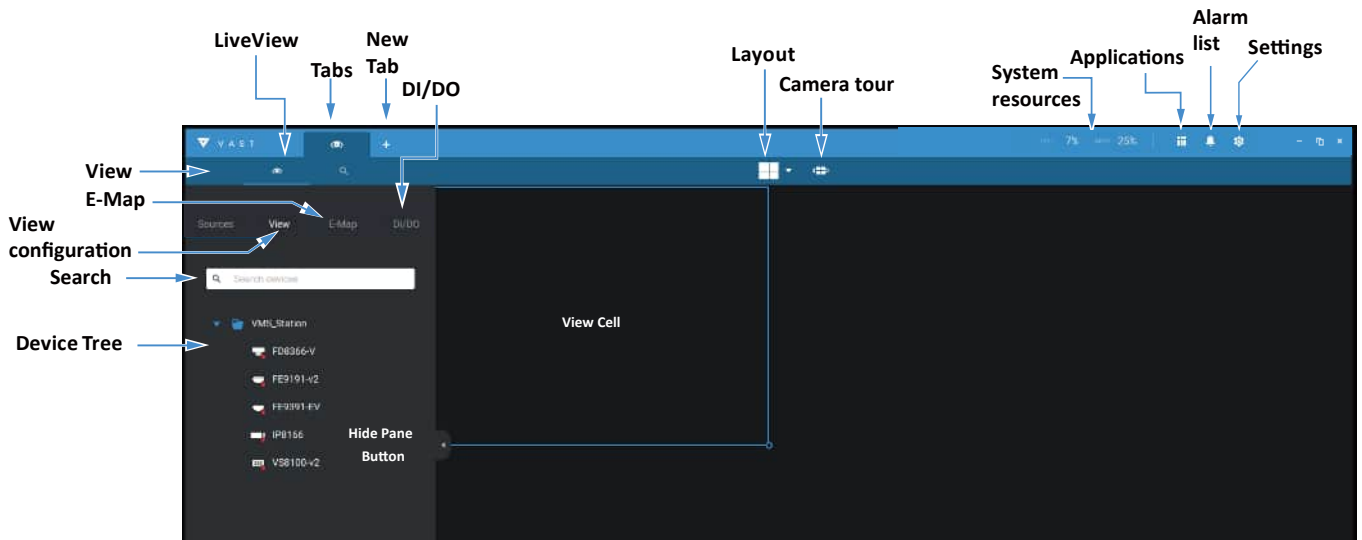
Live view



Playback is evoked when a view cell is selected, and you click the Playback button  on the upper right of the view cell.

Top Tool Bar

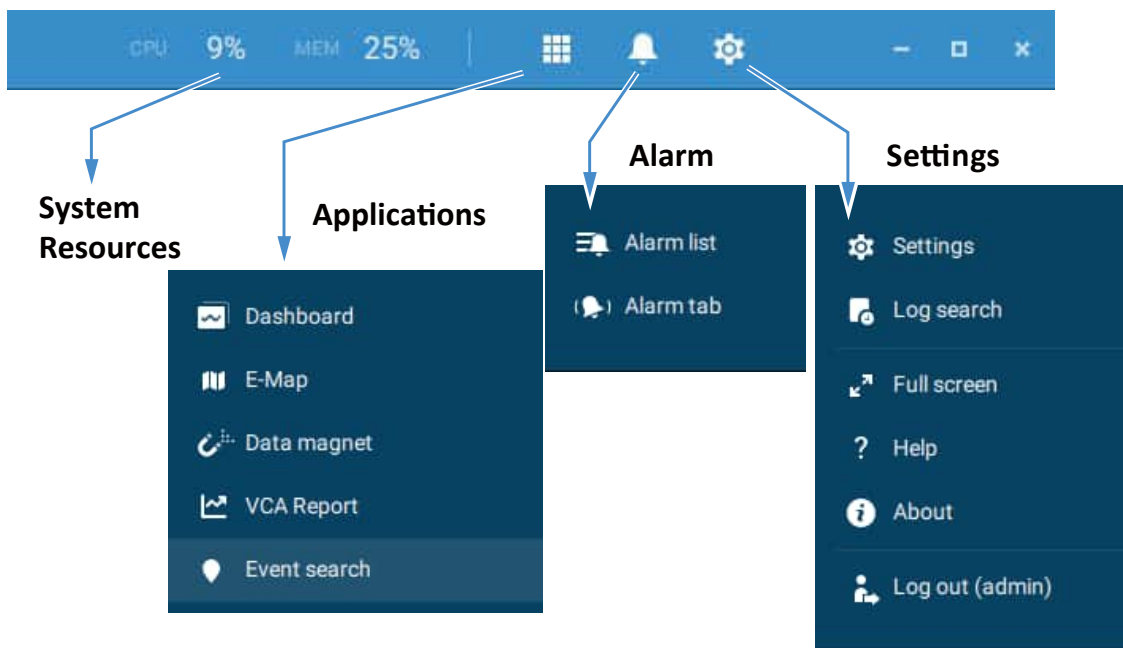

Search Pane

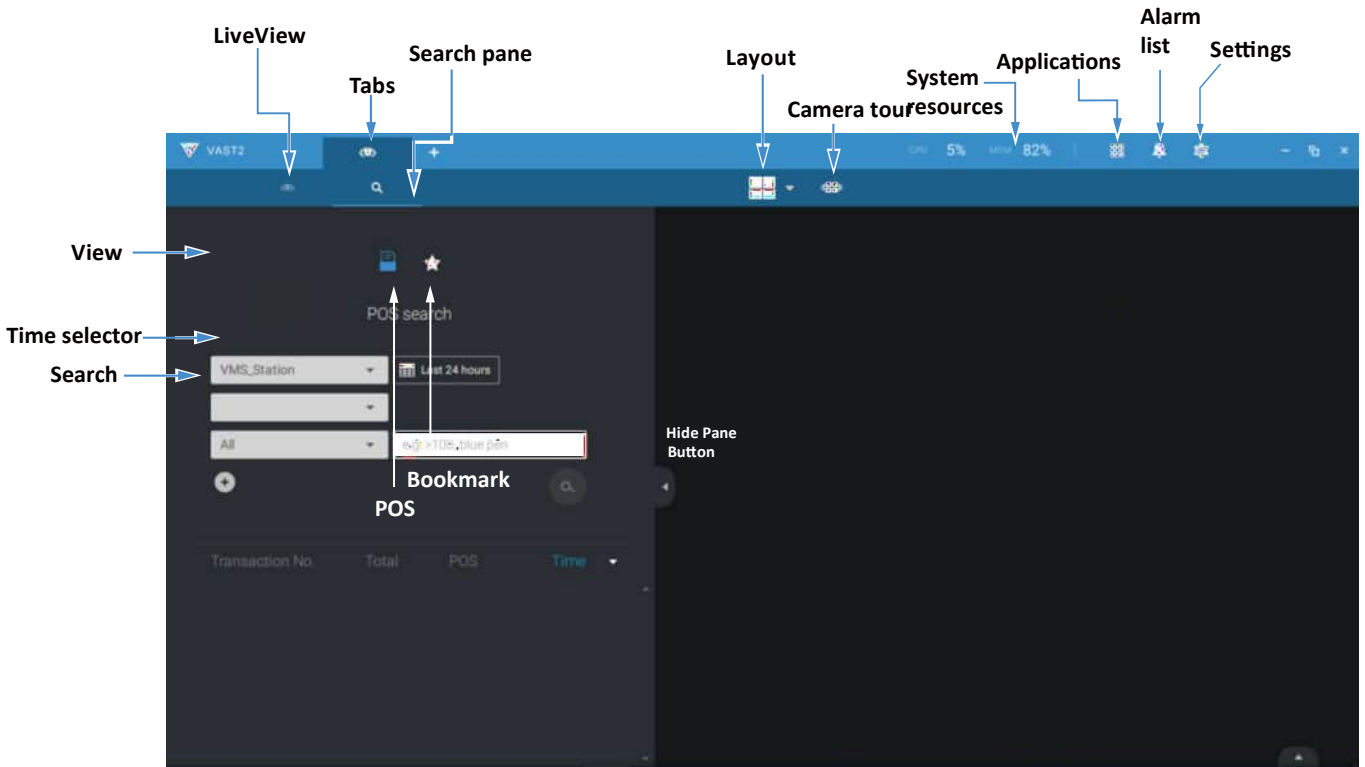

Playback Control

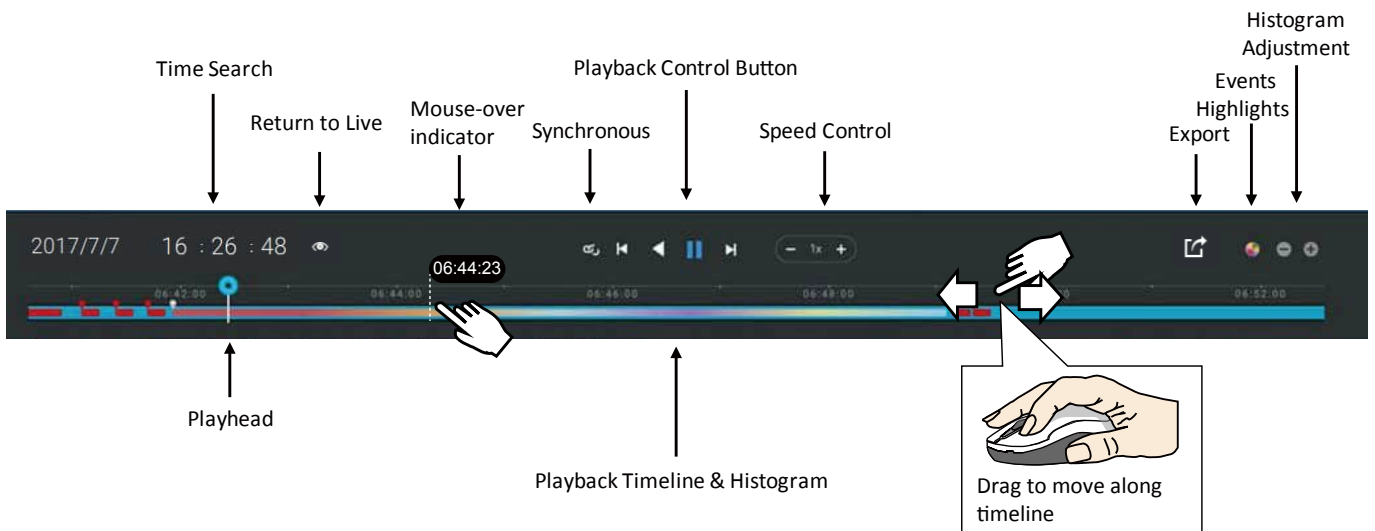

View cell control

Some controls and functions are available when a view cell is selected or via the right-click menus.

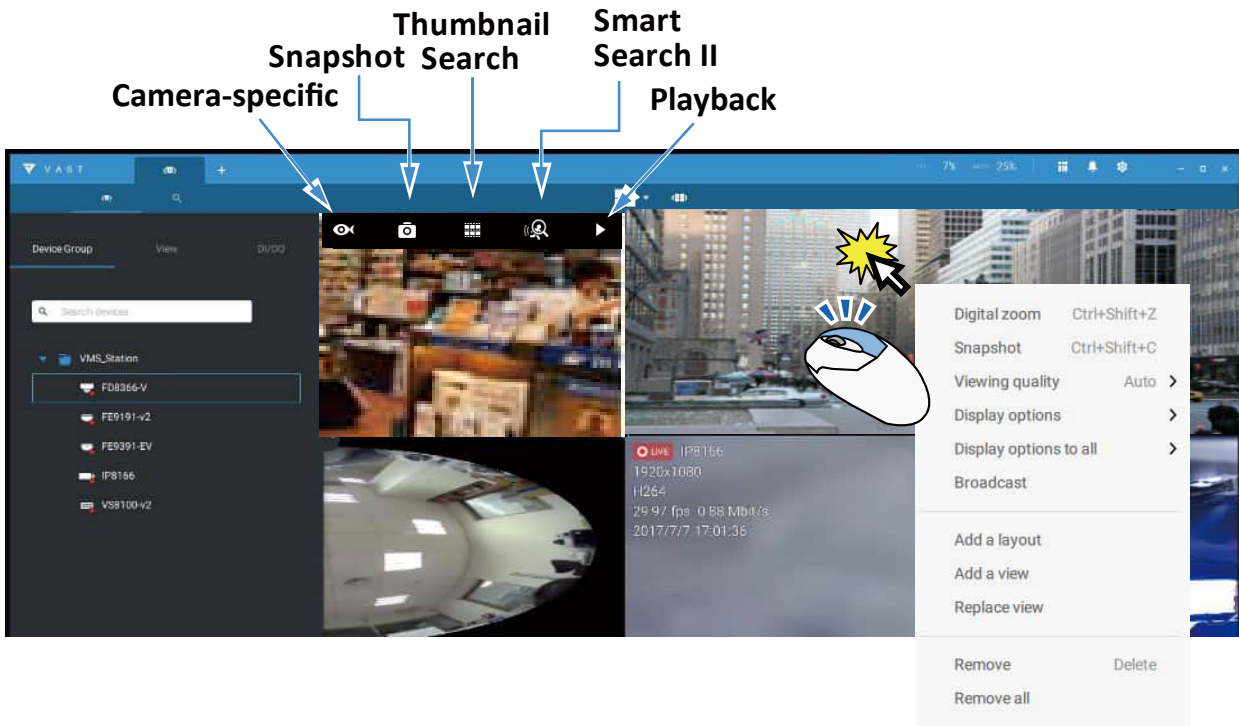

Text overlay

Single-click to select a view cell, right-click and select Display information. The Edit display information tab will appear.

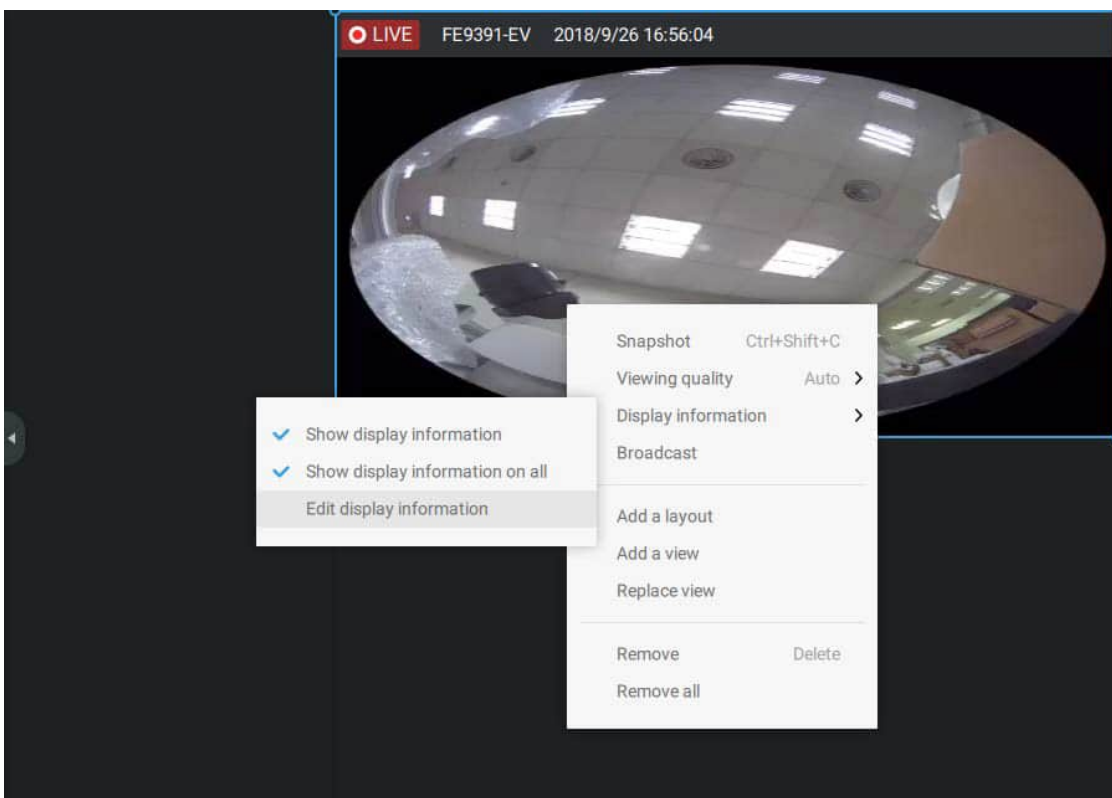

Select the checkboxes to determine what kind of text overlay will display on view cells. Note that you can place the overlay either on top or at the lower screen. Simply click and drag an overlay item to a preferred location. When done, click the Apply button.

You can apply your current configuration to all view cells by selecting the **Apply to all view cells** checkbox. Note that you can also display the VCA rules and areas on screen.

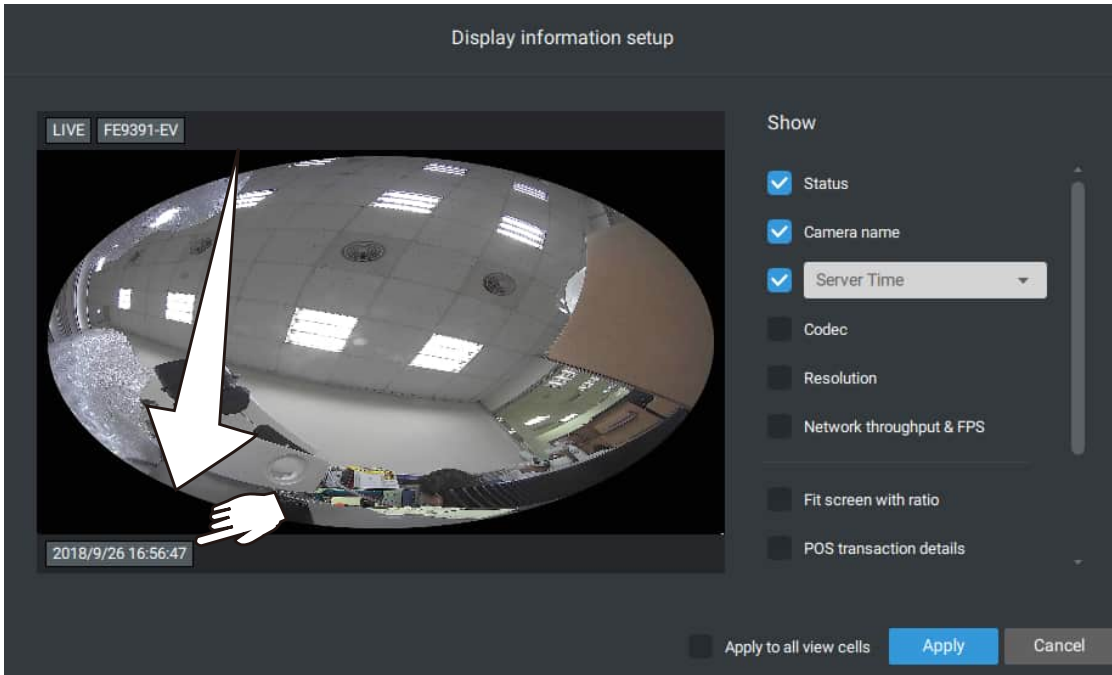

Two Way Audio

If your cameras support the Two Way Audio feature and the microphone and audio output to an amplified speakers have been connected, you can right-click on the camera to display the Broadcast function. Click on the Microphone icon in the middle to start speaking. Click again to stop the Two Way Audio.

Note that the Broadcast option only appears when you select a camera that supports the Two Way Audio feature. Currently the VAST2 software supports 1 to 1 broadcast.

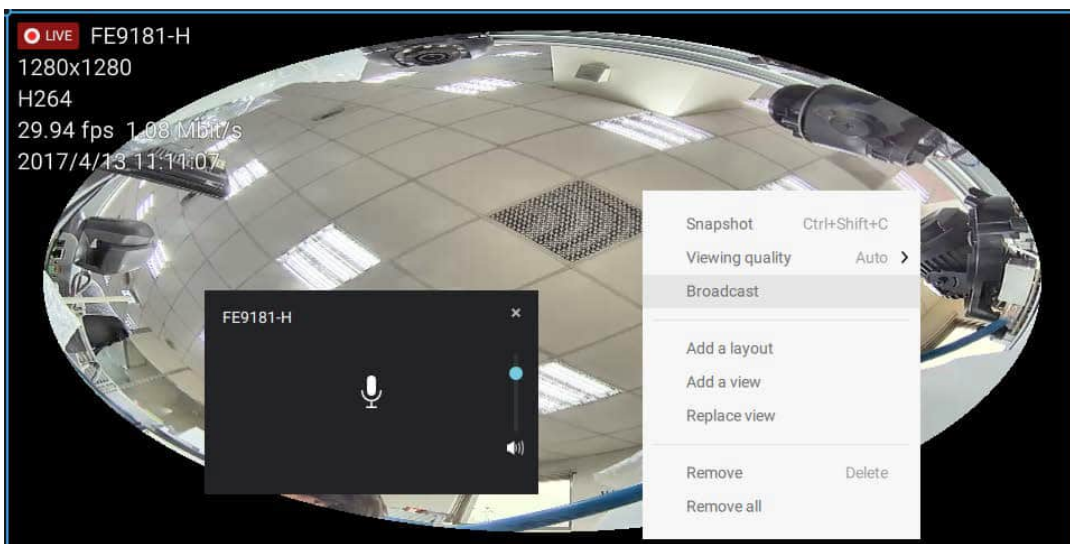

Full Screen

The full screen function maximizes the display of view cells, concealing all other tool bar or navigation panels. To return to the normal view, press the **ESC** key on keyboard.

Log Search

System logs can be found via the tool bar tab. All system events will be listed in the Log search panel. If you have multiple server, substations, select a server. You can search specific events by the event types (All triggers, camera, system/site, external devices), or by the time of occurrence using the calendar tool.

Use the Export button  to export the system log as an individual log file.

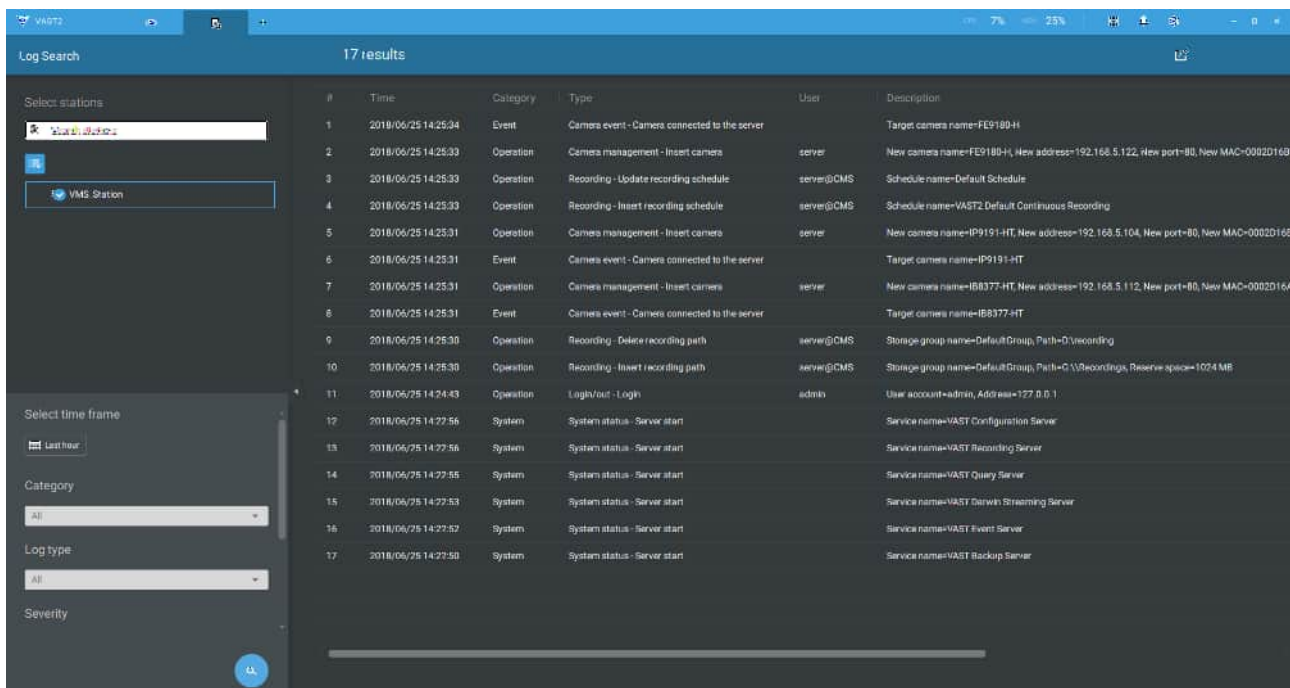

The screenshot displays the VAST2 Log Search interface. On the left, there are filters for 'Select stations' (showing 'VMS Station'), 'Select time frame' (set to 'Last hour'), 'Category' (set to 'All'), 'Log type' (set to 'All'), and 'Severity'. The main area shows a table with 17 results. The table columns are: #, Time, Category, Type, User, and Description.

#	Time	Category	Type	User	Description
1	2018/06/25 14:25:34	Event	Camera event - Camera connected to the server		Target camera name=FE9180-H
2	2018/06/25 14:25:33	Operation	Camera management - Insert camera	server	New camera name=FE9180-H, New address=192.168.5.122, New port=80, New MAC=0002016B...
3	2018/06/25 14:25:33	Operation	Recording - Update recording schedule	server@CMS	Schedule name=Default Schedule
4	2018/06/25 14:25:33	Operation	Recording - Insert recording schedule	server@CMS	Schedule name=VAST2 Default Continuous Recording
5	2018/06/25 14:25:31	Operation	Camera management - Insert camera	server	New camera name=IP9191-HT, New address=192.168.5.104, New port=80, New MAC=0002016B...
6	2018/06/25 14:25:31	Event	Camera event - Camera connected to the server		Target camera name=IP9191-HT
7	2018/06/25 14:25:31	Operation	Camera management - Insert camera	server	New camera name=IB8377-HT, New address=192.168.5.112, New port=80, New MAC=0002016A...
8	2018/06/25 14:25:31	Event	Camera event - Camera connected to the server		Target camera name=IB8377-HT
9	2018/06/25 14:25:30	Operation	Recording - Delete recording path	server@CMS	Storage group name=DefaultGroup, Path=D:\recording
10	2018/06/25 14:25:30	Operation	Recording - Insert recording path	server@CMS	Storage group name=DefaultGroup, Path=C:\Recording, Reserve space=1024 MB
11	2018/06/25 14:24:43	Operation	Login/out - Login	admin	User account=admin, Address=127.0.0.1
12	2018/06/25 14:22:56	System	System status - Server start		Service name=VAST Configuration Server
13	2018/06/25 14:22:56	System	System status - Server start		Service name=VAST Recording Server
14	2018/06/25 14:22:55	System	System status - Server start		Service name=VAST Query Server
15	2018/06/25 14:22:53	System	System status - Server start		Service name=VAST Dsrwh Streaming Server
16	2018/06/25 14:22:52	System	System status - Server start		Service name=VAST Event Server
17	2018/06/25 14:22:50	System	System status - Server start		Service name=VAST Backup Server

Log Level

Minor : Level 6~8

Normal : Level 3~5

Major : Level 1~2

Operation

VAST2 Type	Log Type	ID	Level	Sample	Extra Parameters																
Login/out	Login	1	3	User Account=admin, Address=127.0.0.1	User account	Address															
	Logout	2	3	User Account=admin, Address=127.0.0.1	User account	Address															
User	Insert user	101	4	New User Name=guest, New Role=PowerUser, New Permission=000F01013F0201070307FFF6F77EFD4E00	New User Name	New Role	New Permission														
	Update user password	104	5	Target User Name=guest	Target User Name																
	Update user privilege	105	5	Target User Name=guest, Target Role=PowerUser, Target Permission=000F01013F0201070307FFF6F77EFD4E00, New User Name=guest, New Role=PowerUser, New Permission=000F01013F0201070307FFF6F77EFD4E00	Target User Name	Target Role	Target Permission	New User Name	New Role	New Permission											
	Delete user	106	3	Target User Name=guest	Target User Name																
	Update user expiration	107	5	Target User Name=guest	Target User Name																
Site	Insert station	201	4	New Station Name=VMS_Station, New Address=172.18.60.31, New Port=3454, New UseSSL=0, New RTSP Port=3454, New Station ID=S_{6312FAC9-FCF4-4573-964D-5F03D083BE54}	New Station Name	New Address	New Port	New UseSSL	New RTSP Port	New Station ID											

	Update station information	202	5	Target Station Name={6312FAC9-FCF4-4573-964D-5F03D083BE54}, Target Address=172.18.60.31, Target Port=3454, Target UseSSL=0, Target RTSP Port=3454, New Station Name={6312FAC9-FCF4-4573-964D-5F03D083BE54}, New Address=172.18.60.31, New Port=3443, New UseSSL=1, New RTSP Port=3443	Target Station Name	Target Address	Target Port	Target UseSSL	Target RTSP Port	New Station Name	New Address	New Port	New UseSSL	New RTSP Port						
	Update station name	203	5	Target Station Name=VMS_Station, New Station Name=CMS	Target Station Name	New Station Name														
	Delete station	204	3	Target Station Name=VMS_Station, Target Station ID=S_{6312FAC9-FCF4-4573-964D-5F03D083BE54}	Target Station Name	Target Station ID														
	Set relay settings	1716	5	Enable=true	Enable															
	Station enable multicast	2416	5	Station name=VMS_Station	Station name															
	Station disable multicast	2417	5	Station name=VMS_Station	Station name															
Camera	Insert camera	205	4	New Camera Name=Door, New Address=172.18.1.129, New Port=80, New MAC=0002D11CC24E, New HTTPS Port=443, New Recording Stream=1	New Camera Name	New Address	New Port	New MAC	New HTTPS Port	New Recording Stream										
	Update camera information	206	5	Target Camera Name=Door, Target Address=172.18.1.129, Target Port=80, Target MAC=0002D11CC24E, Target HTTPS Port=443, Target Recording Stream=1, New Camera Name=IP8362, New Address=172.18.1.129, New Port=80,	Target Camera Name	Target Address	Target Port	Target MAC	Target HTTPS Port	Target Recording Stream	New Camera Name	New Address	New Port	New MAC	New HTTPS Port	New Recording Stream				

	path																			
	Insert camera to the storage group	417	4	Storage Group Name=Office, Camera Name=IP8362	Storage Group Name	Camera Name														
	Delete camera from the storage group	419	3	Storage Group Name=Office, Camera Name=IP8371E	Storage Group Name	Camera Name														
Network	Update server port	1701	5	Server Name=Web, Port=3455	Server Name	Port														
	Set proxy server	1702	5	Enable=True, Address=172.18.60.13, Port=80	Enable	Address	Port													
	Set UPnP	1703	5	UPnP Port Forwarding Enable=False, UPnP Presentation Enable=True	UPnP Port Forwarding Enable	UPnP Presentation Enable														
	Set DDNS server	1704	5	Enable=True, Provider= Dyndns.org (Dynamic)	Enable	Provider														
Alarm	Insert alarm management	408	4	Alarm name=alarm, Trigger list=Motion detection - Motion window 1 of Network Camera, Action list=Set DO status - DO-1 of Network Camera	Alarm name	Trigger list	Action list													
	Update alarm management	409	5	Alarm name=alarm, Trigger list=Motion detection - Motion window 1 of Network Camera, Action list=Set DO status - DO-1 of Network Camera	Alarm name	Trigger list	Action list													
	Delete alarm management	410	3	Alarm name=alarm	Alarm name															
	Stop alarm sound	2408	7	Alarm name=alarm	Alarm name															

	Close alarm notification panel	2409	7	Alarm name=alarm	Alarm name															
	Mute alarm	2411	7	Alarm name=alarm, Duration=10mins,	Alarm name															
PTZ	Camera PTZ, Iris, Focus, Pan, Patrol control	702	7	Target Camera Name=SD9361-EH	Target Camera Name															
	Click on image	703	7	Target Camera Name=SD9361-EH	Target Camera Name															
	Select preset location	704	7	Target Camera Name=SD9361-EH, Preset Name=Door	Target Camera Name	Preset Name														
Backup	Update scheduled backup	1503	5	Enable=true	Enable															
License	Update license information	1717	5	(Empty)																
System	Create directory	1705	4	Target Path=E:\test	Target Path															
	Rename directory	1706	5	Source Path=E:\test, Target Path=E:\recording	Source Path	Target Path														
	Delete directory	1707	3	Target Path=E:\recording	Target Path															
	Update server database path	3401	3	Old path=E:\clientlogs, Target Path=E:\test																
	Insert SMTP	1708	4	Target Address= mail.vivotek.tw , Target Port=25, Target	Target Address	Target Port	Target Order													

	server			Order=0														
	Update SMTP server	1709	5	Target Address= mail.vivotek.tw , Target Port=25, Target Order=0, New Address= mail.vivotek.com , New Port=25, New Order=0	Target Address	Target Port	Target Order	New Address	New Port	New Order								
	Delete SMTP server	1710	3	Target Address= mail.vivotek.tw , Target Port=25, Target Order=0	Target Address	Target Port	Target Order											
	Insert network storage	1711	4	Target Host=rd2fs, Target Domain=vivotek	Target Host	Target Domain												
	Update network storage	1712	5	New Host=rd2fs, New Domain=vivotek, Target Host=rd2fs, Target Domain=vivotek	New Host	New Domain	Target Host	Target Domain										
	Delete network storage	1713	3	Target Host=rd2fs, Target Domain=vivotek	Target Host	Target Domain												
	Watermark settings	2418	5	Status=Disable Status=Enable	Status													
	Import device pack	1721	4	Original version=xxxx, New version=ooo	Original version	New version												
	Import device pack failed	1722	4	Reason=Invalid device pack Reason=Failed to import device pack	Reason													
Live	Add camera	2402	7	New Camera(s) = C1, Total Camera(s) in View= C1,C2	New Camera(s)	Total Camera(s) in View												
	Remove camera	2403	7	Removed Camera(s) = C1, Total Camera(s) in View= C2	Removed Camera(s)	Total Camera(s)												

	Replace camera	2404	7	Removed Camera(s) = C1, New Camera(s) = C2,C3 Total Camera(s) in View= C2,C3	Removed Camera(s)	New Camera(s)	Total Camera(s) in View												
View	Add view	2401	5	View Name = View001, Add Camera(s) = C_1	View Name	Add Camera(s)													
	Delete view	2405	5	View Name = View001, Removed Camera(s) = C_1, C_3	View Name	Removed Camera(s)													
	Update view	2406	5	View Name = View001, Removed Camera(s) = C_3, Add Camera(s) = C_1, Total Camera(s) in View= C_1, C_2	View Name	Removed Camera(s)	Add Camera(s)	Total Camera(s) in View											
	Rename view	2407	5	Old View Name = View001, New View Name = View002, Total Camera(s) in View= C1, C_2	Old View Name	New View Name	Total Camera(s) in View												
Data magnet	Add data source	2601	4	Name=Lane, Port=1234, Camera name=FE8173	Name	Port	Camera name												
	Update data source	2602	5	Target name=Lane, Targe port=1234, Target camera name=FE8173, New name=Lane, New port=4321, New camera name=IP8362	Target name	Targer port	Target camera name	New name	New port	New camera name									
	Delete data source	2603	3	Name=Lane	Name														
	Show data	2604	7	Enable=True, Camera name=FE8173	Enable	Camera name													
EMap	Add EMap	3201	7	New EMap(s) = /Dessert, Total EMap(s) in View= /Dessert,Penguin	New EMap(s)	Total EMap(s) in View													
	Delete EMap	3202	7	Removed EMap(s) = /Dessert, Total EMap(s) in View=	Removed EMap(s)	Total													

			/Penguin		EMap(s) in View														
	Replace EMap	3203	7	Removed EMap(s) = /Desert, New EMap(s) = /Flower,/Lion Total EMap(s) in View= /Flower,/Lion	Removed EMap(s)	New EMap(s)	Total EMap(s) in View												
VCA Report	Auto update report	2801	5	VCA Chart Auto Update=true	VCA Chart Auto Update														
	Auto update frequency	2802	5	VCA Chart Update Frequency=999	VCA Chart Update Frequency														
Matrix	Assign component	3001	7	User=admin, assign component=Google map, to client=WIN-458HOD5571M, screen=1	User name	Component	Client name	Screen ID											
	Reset all	3002	7	User=admin, reset all screen to client=WIN-458HOD5571M	User name	Client name													
PPTZ Control	PPTZ Control	2410	7	Enable=True, Camera name=FE8173															

Event

VAST2 Type	Log Type	ID	Level	Sample	Extra Parameters															
Camera	Camera disconnected from server	1101	2	Target Camera Name=SC8131	Target Camera Name															
	Camera connected to the server	1102	2	Target Camera Name=SC8131	Target Camera Name															
System	Parent station disconnected	1201	2	Target Station Name=VMS_Station	Target Station Name															
	Parent station connected	1202	2	Target Station Name=VMS_Station	Target Station Name															
	Parent station connection lost	1203	2	Target Station Name=VMS_Station	Target Station Name															

	Parent station connection restored	1204	2	Target Station Name=VMS_Station	Target Station Name															
	Substation disconnected	1205	2	Target Station Name=NV9411P	Target Station Name															
	Substation connected	1206	2	Target Station Name=NV9411P	Target Station Name															
	Substation connection lost	1207	2	Target Station Name=NV9411P	Target Station Name															
	Substation connection restore	1208	2	Target Station Name=NV9411P	Target Station Name															
	Start scheduled backup	1501	2	Backup Path=E:\backup, Backup Interval=2018/02/05 00:00:01-2018/02/06 23:58:40	Backup Path	Backup Interval														
	Stop scheduled backup	1502	2	Backup Result Desc=Backup Finish, Backup Interval=2018/02/05 00:00:01-2018/02/06 23:58:40, Backup Latest End Time=2018-02-06 23:58:40.506	Backup Result Desc	Backup Interval	Backup Latest End Time													
	Schedule backup error	1504	2	Media File Source Path=D:\recording\2018-02-04\2-SC8131\1_2018-02-04_000001.3gp, Backup Destination Path=E:\backup, Reason=source is not exist	Media File Source Path	Backup Destination Path	Reason													
Alarm	Alarm trigger	1601	2	Alarm Name=Test, Trigger Type=DO, Action Type=Start to record on	Alarm Name	Trigger Type	Action Type													

System

VAST2 Type	Log Type	ID	Level	Sample	Extra Parameters																
System	Server start	1001	1	Service Name=VAST Configuration Server	Service Name																

Server stop	1002	1	Service Name=VAST Configuration Server	Service Name															
Trial expired	1003	1	(Empty)																
Key dongle lost	1004	1	(Empty)																
Virtual memory low	1005	1	(Empty)																
Network lost	1006	1	(Empty)																
Camera MAC invalid	1007	1	(Empty)																
License invalid	1008	1	Invalid Item=Number of VIVOTEK camera(s) exceeded	Invalid Item															
Storage lost	1602	2	Path=Volume1	Path															
Failover start	2301	1	Active Station Name=CMS, Active Station ID=S_{f2725102-d790-4bbb-9f27-ab10356b55bd}, Redundant Station Name=NVR, Redundant Station ID=S_{50ef2623-7143-50d2-9e09-7552798e0e2b}	Active Station Name	Active Station ID														
Failover stop	2302	1	Active Station Name=CMS, Active Station ID=S_{f2725102-d790-4bbb-9f27-ab10356b55bd}, Redundant Station Name=NVR, Redundant Station ID=S_{50ef2623-7143-50d2-9e09-7552798e0e2b}	Active Station Name	Active Station ID														
Start NVR backup	2412	2	Station name=NVR, Reason=Backup triggered	Station name	Reason														
Stop NVR backup	2413	2	Station name=NVR, Reason=Backup Finished	Station name	Reason														

Alarm list

The Alarm list is accessed from the top tool bar. The Alarm list provides easy access to all triggered alarms, such as tampering alarms, alarms reported by VCA analytics, external devices connected via a camera's DI pin, etc.

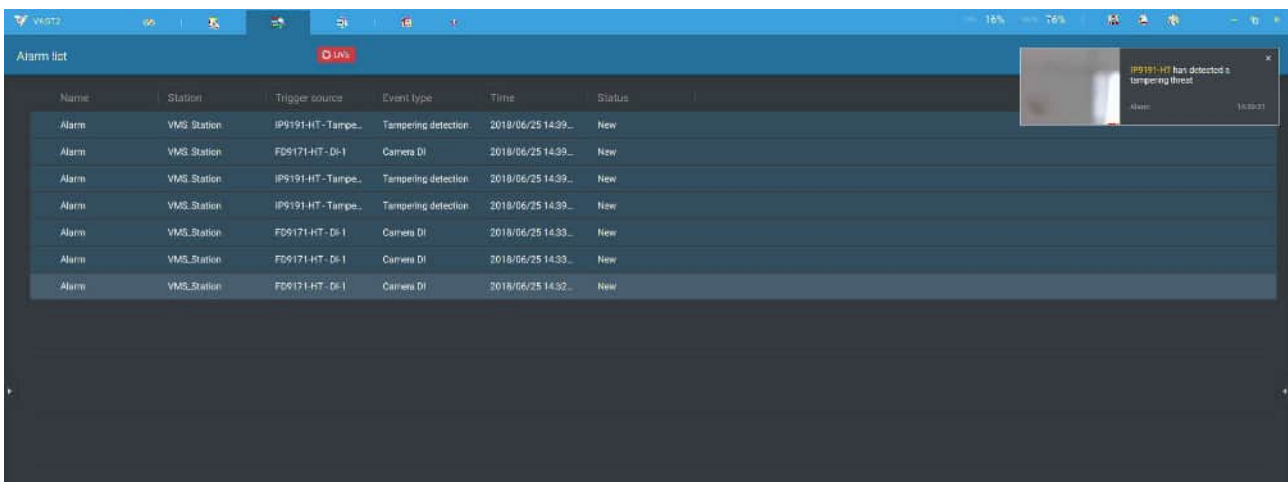
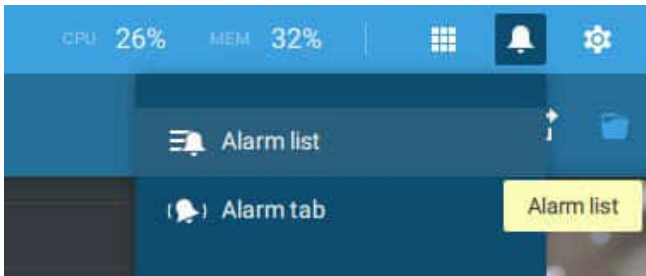

The Alarm list can be displayed in either the List view or Thumbnail view.

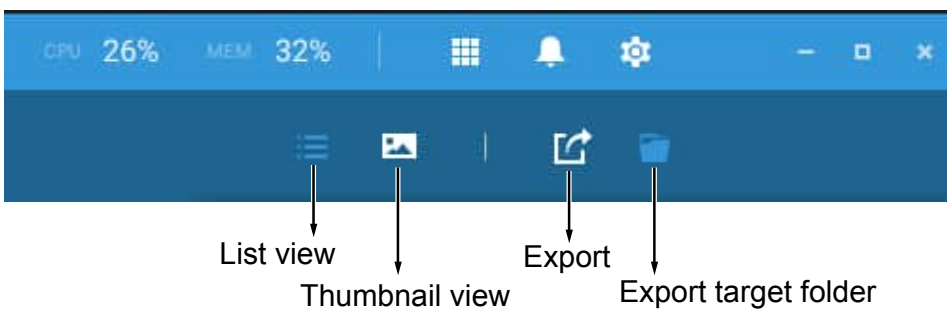

Below is an example of a Thumbnail view.

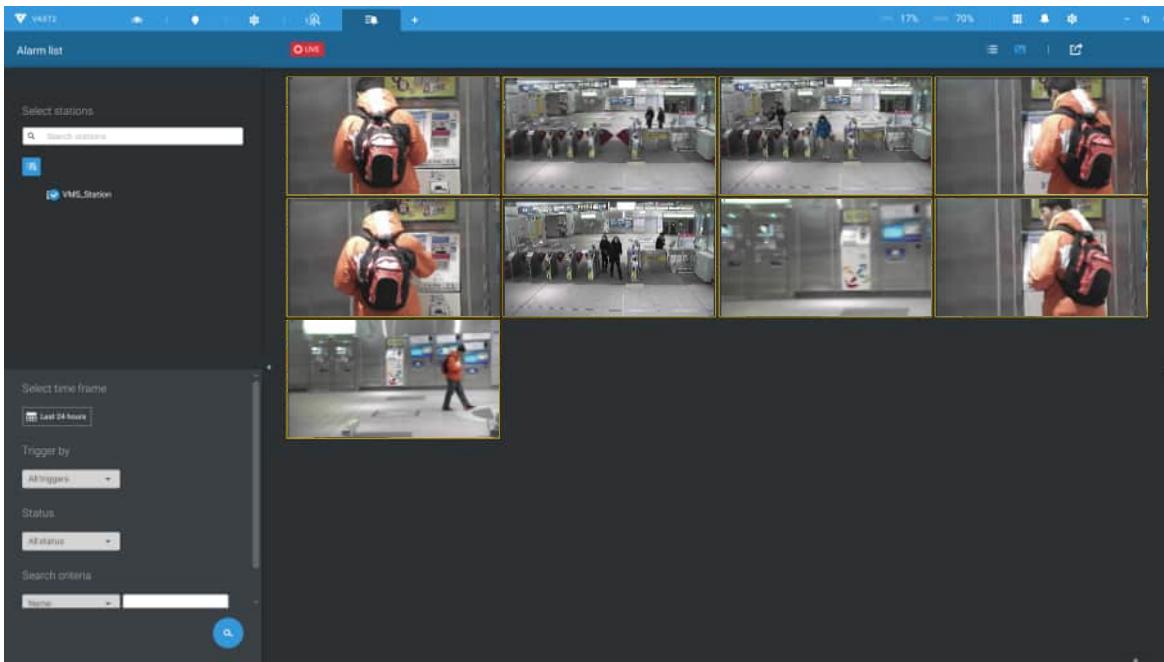

On the Alarm list, you can double-click to select a triggered alarm. A related snapshot and configuration panel will appear. An operator can select the Status menu to change the event management status. The configurable statuses can be:

1. **New**: An event that has not been handled.
2. **In progress**: Select to indicate that the event is being handled, e.g., a security personnel has been sent to verify the cause of the event.
3. **False alarm**: Used to indicate the event has been verified as a false alarm.
4. **Close**: A closed case event will be erased from the event list.

When done with designating event status, click the **Acknowledgment** button.

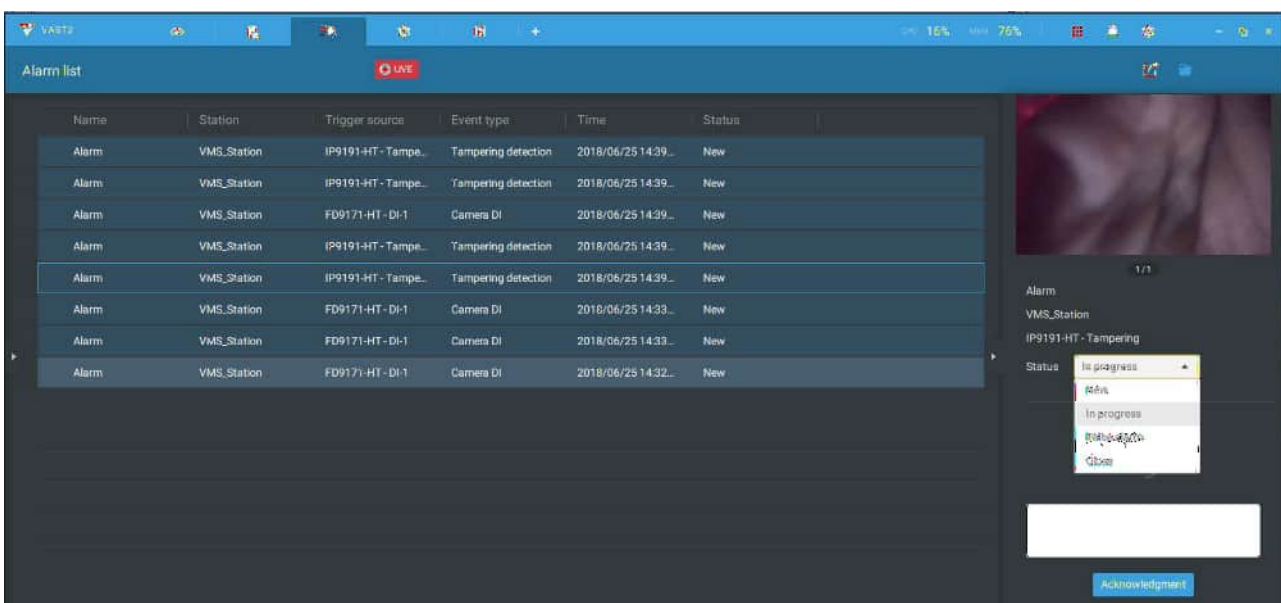

The Alarm list also supports Hot keys.

Alarm list window			
Mute the current alarm	Ctrl		m
Designate the selected alarms as false alarms	Ctrl		f
Select all alarms	Ctrl		a
Select one or multiple alarms	Ctrl		left mouse button
Select multiple alarms		Shift	left mouse button
Select different alarms			Up/Down/Left/Right

When an alarm is muted, a message will prompt asking for how long the alarm will be muted. Enter a number, and the alarm will disappear from the list temporarily.

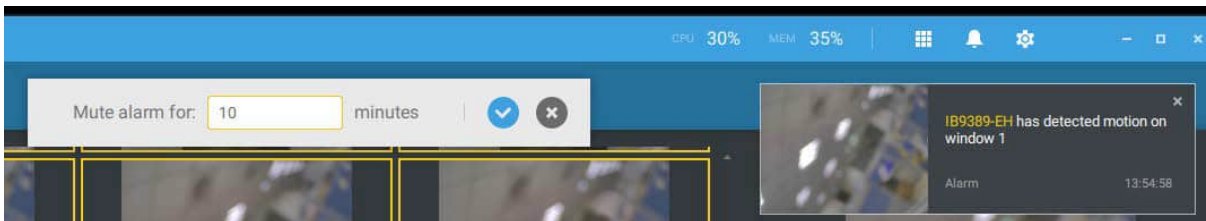

When an alarm is designated as a false alarm, it is immediately removed from the list.

When an alarm is designated as In progress, you can add a comment on the current condition, and click Acknowledge to change its status.

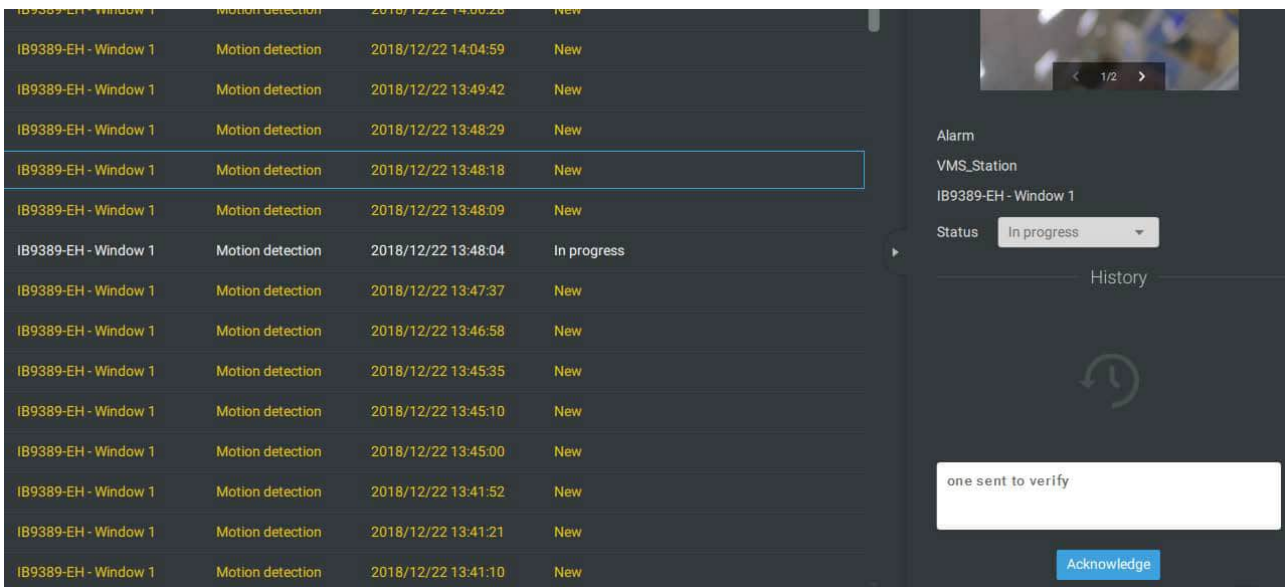

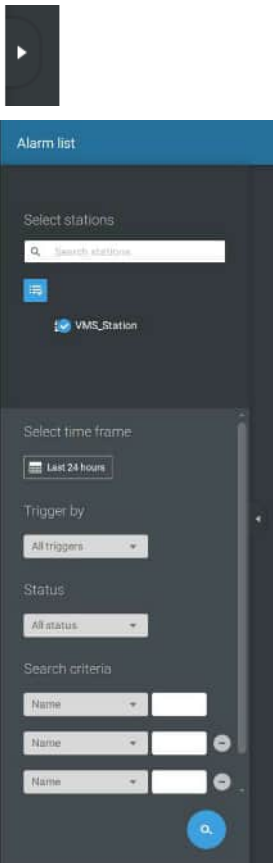

To find alarms of specific types, time of occurrences, and alarm status, click the side tab to reveal the search panel.

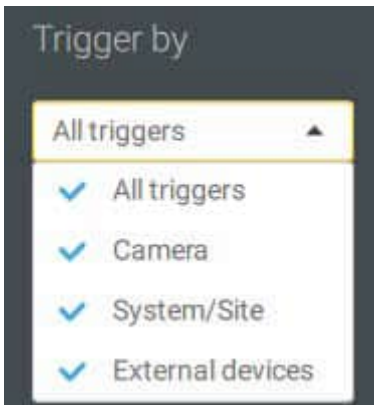

You can select the trigger source, e.g., when you need to see camera alarms only.

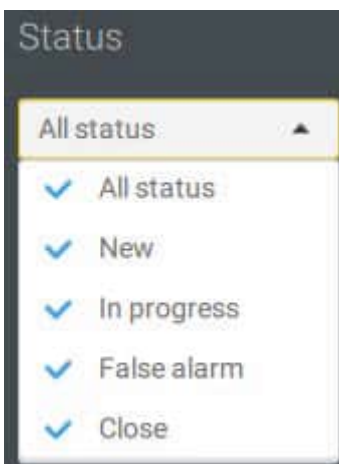

You can check to see alarms of a specific status. For example, you can select to search for the "In progress" alarms only.



You can enter one or multiple keywords as the search criteria. For example, if you have an alarm named as "Alarm3-sidewalk," use the name as the keyword to search for the related alarms.

You can use the Export button  to export a full list of all triggered events into a CSV file. The event type, receiving station, triggering device, time of occurrence, and event status will all be listed. You can also export alarm-triggered videos.

You can also add a comment for an event by entering the description in the comment entry field.

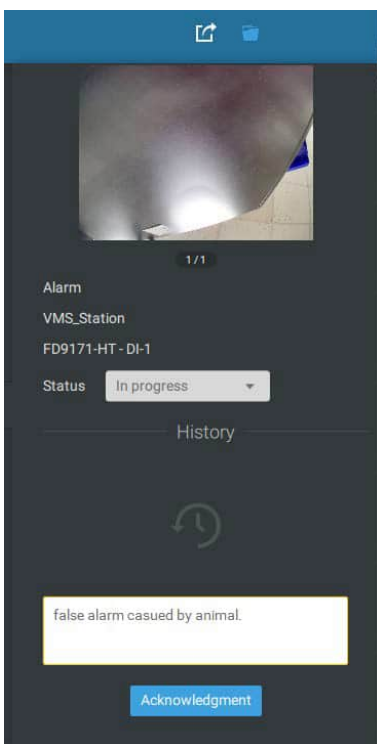

To review the alarm-related video, click to select an alarm, double-click to playback. The Playback window will appear on the upper right of the screen.

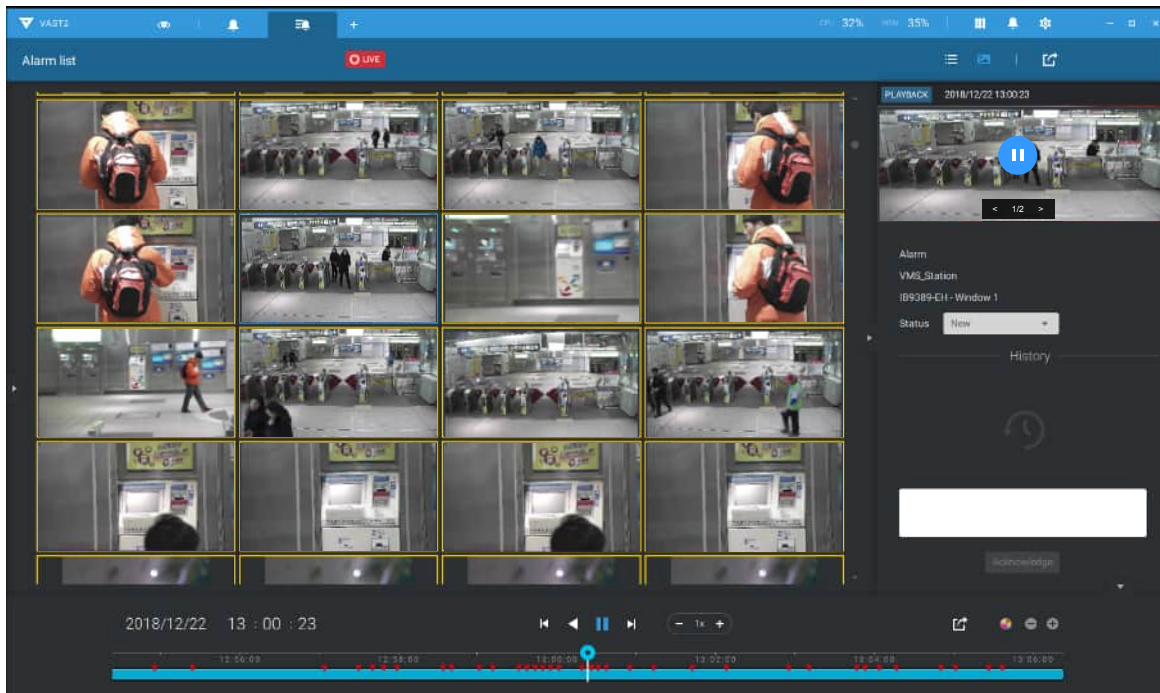

Double-click on the small playback screen again to bring it to the full view. The playback control, time line, export, and alarm tags will be available on screen.

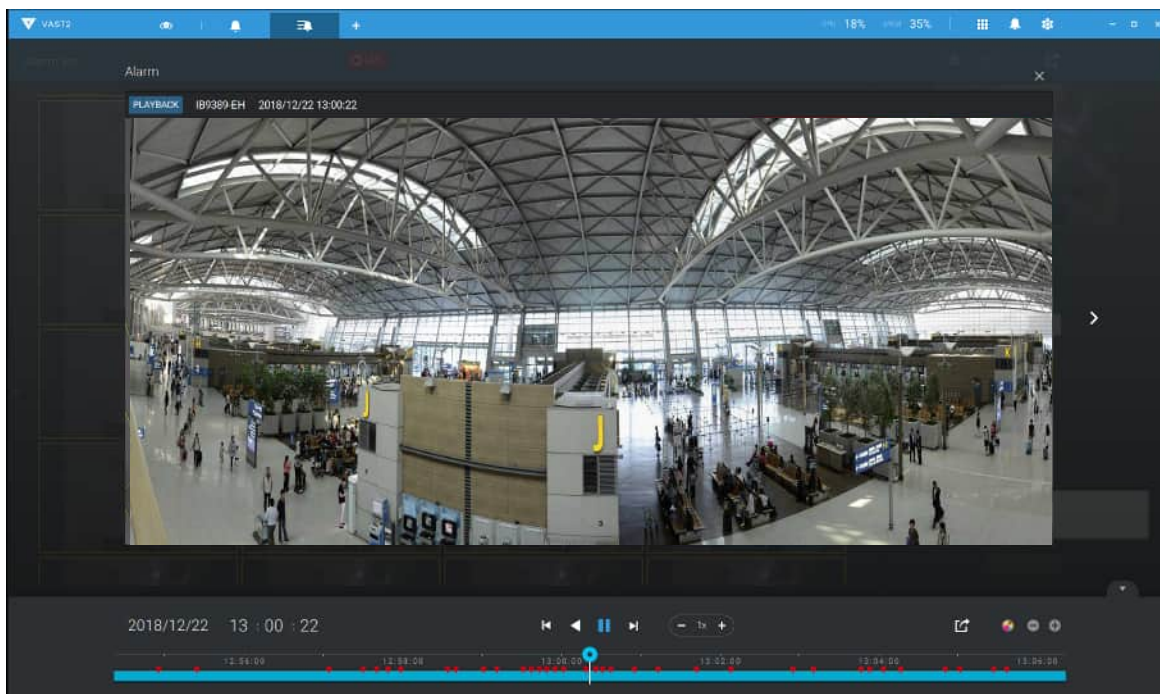

Alarm tab

The Alarm tab is an automated streaming window displaying live videos by the triggered alarms. If you configure an alarm action as "Send live streaming," the alarm streaming will be displayed in this window. Note that this window does not display other alarms.

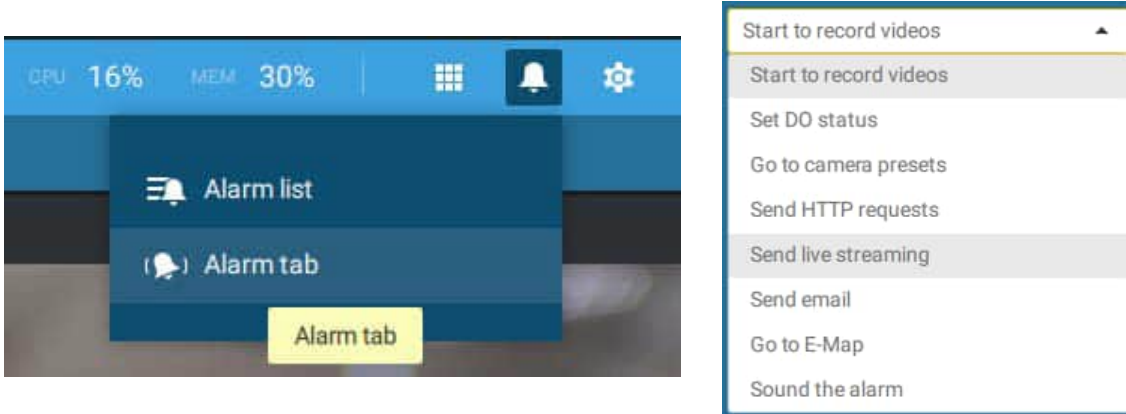

When a live streaming is sent with an alarm, an orange ringing bell icon will display.

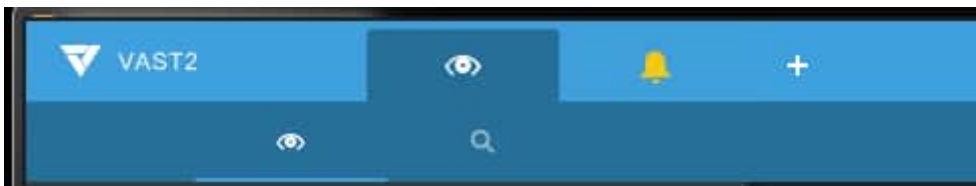

An alarm prompt will also display on the screen.



You can click on the ringing bell icon to open the Alarm tab window. The alarm-triggered streamings will be available on screen.

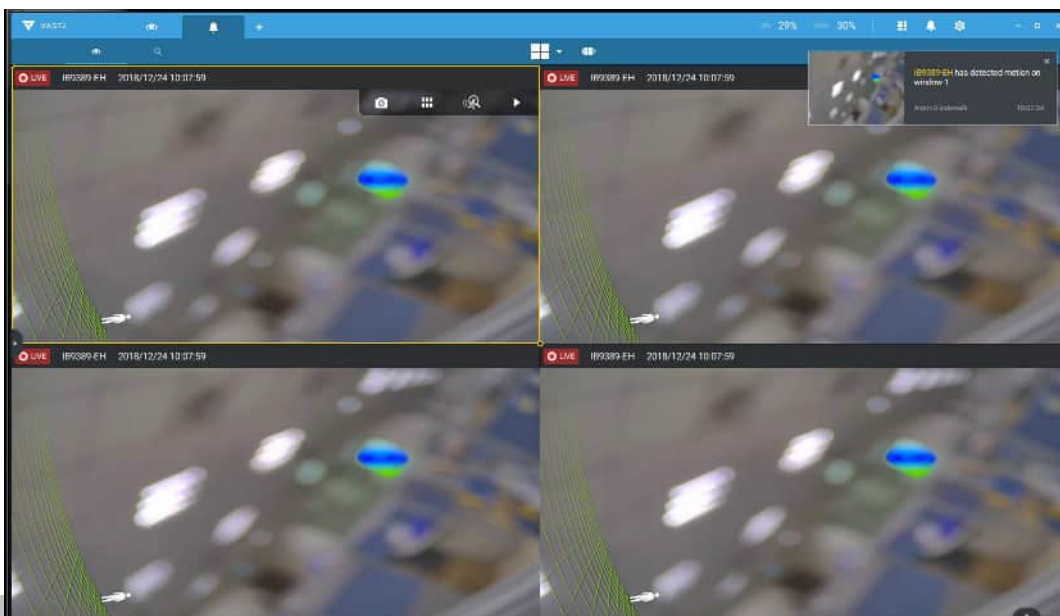

Hot Keys

Open online document			F1
Close current tab	Ctrl (Win) / Command (MacOS)		W
Open new Live / Playback tab	Ctrl (Win) / Command (MacOS)		T
Full screen	Ctrl (Win) / Command (MacOS)	Shift	F
Exit full screen	Ctrl (Win) / Command (MacOS)	Shift	F
Exit full screen			Esc
View cell			
Select view cell			Arrow keys
Digital zoom	Ctrl (Win) / Command (MacOS)	Shift	Z
Snapshot	Ctrl (Win) / Command (MacOS)	Shift	C
Instant bookmark	Ctrl (Win) / Command (MacOS)	Shift	B
Remove camera from cell			Del
Move to preset position	Ctrl (Win) / Command (MacOS)		Digits (1,2,3,...)
PTZ model up, down, left, right			Arrow keys
Save current layout as a customized layout	Ctrl (Win) / Command (MacOS)		S
Undo layout modification	Ctrl (Win) / Command (MacOS)		Z
Redo layout modification	Ctrl (Win) / Command (MacOS)		Y
Timeline			
Sync Playback mode	Ctrl (Win) / Command (MacOS)	Shift	S
Pause (Play/Rewind)			Space
Play	Ctrl (Win) / Command (MacOS)		Arrow right
Rewind	Ctrl (Win) / Command (MacOS)		Arrow left
Speed up	Ctrl (Win) / Command (MacOS)		Up
Speed down	Ctrl (Win) / Command (MacOS)		Down
Next frame		Shift	Arrow right
Previous frame		Shift	Arrow left
Reset speed to 1x	Ctrl (Win) / Command (MacOS)		1 (one)

Smart search II			
- Configuration page			
Delete detection range			Esc

Bookmark search			
Select more bookmarks	Ctrl (Win) / Command (MacOS)		Click
Select more bookmarks		Shift	Click
Back to bookmark page			Esc
Next bookmark			Arrow right
Previous bookmark			Arrow left
Thumbnail search			
Select thumbnail			Arrow keys
Play a selected thumbnail			Enter
Back to Thumbnail page			Esc
Next Thumbnail			Arrow right
Previous Thumbnail			Arrow left
Emap Setup			
- Google map			
Remove selected GPS			Del
DI/DO Device Settings			
Remove selected external I/O device			Del
SMTP Settings			
Remove selected SMTP server			Del
Camera Management			
Rename selected camera			F2
Rename selected folder			F2
Remove selected camera from system			Del
Sites Management			
Rename selected site			F2
Remove selected site from system			Del
Users Settings			
Remove selected user			Del
Schedule Settings			
Remove scheduled time frame			Del

Data Magnet			
Move selected row			Up / Down
Show detail of selected row			Enter
View management			
Rename selected view			F2
Delete selected view			Del
Alarm management			
Delete selected alarm			Del
Alarm list window			
Mute the current alarm	Ctrl (Win) / Command (MacOS)		m
Designate the selected alarms as false alarms	Ctrl (Win) / Command (MacOS)		f
Select all alarms	Ctrl (Win) / Command (MacOS)		a
Select one or multiple alarms	Ctrl (Win) / Command (MacOS)		left mouse button
Select multiple alarms		Shift	left mouse button
Select different alarms			Up/Down/Left/Right

View Cell Elements

On a view cell, the control elements are different with different types of network cameras. 3 major types are listed below with applicable screen elements:

1. **Fixed** cameras:  Snapshot - Thumbnail search - Smart search - Replay.

2. **Fisheye** cameras:  Fisheye display mode - Snapshot - Thumbnail search - Smart search - Replay.

The Auto pan function applies only to the Regional views. Select a regional view, and click the Auto pan button. The Regional view will pan from side to side to cover more viewable regions. If a fisheye is mounted on wall, a regional view with auto pan can cover a panoramic view region.

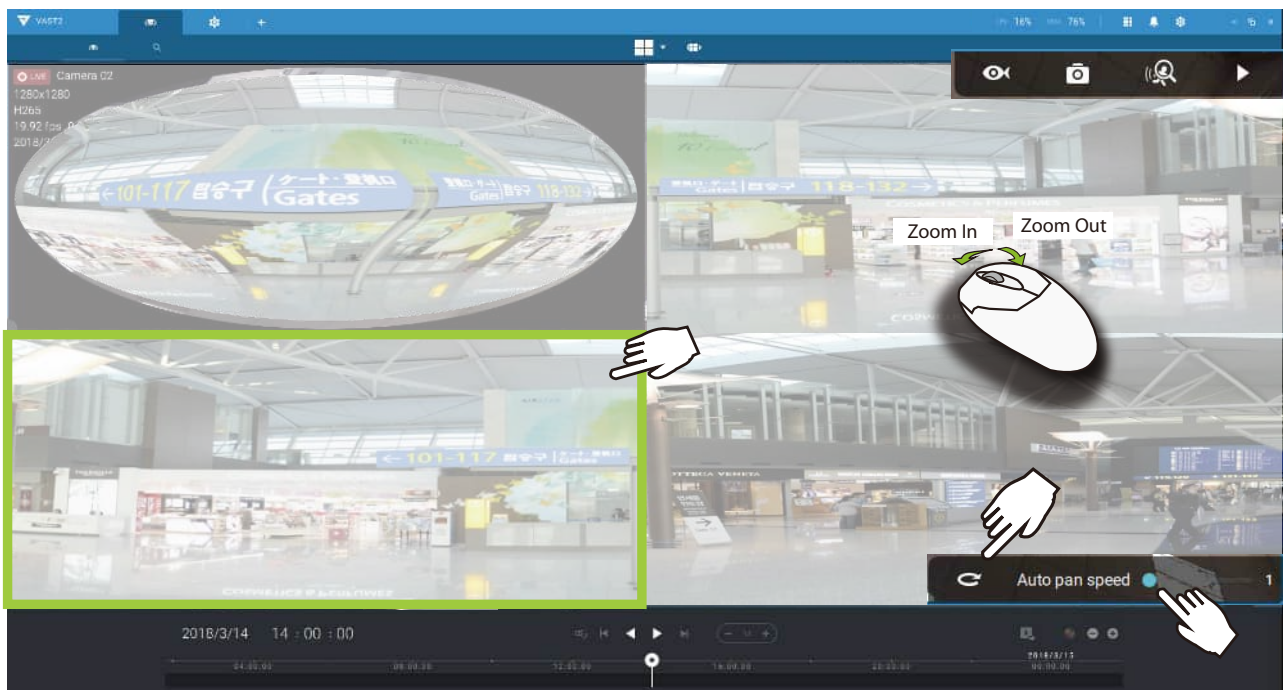

3. **PTZ** cameras:  PTZ - Snapshot - Thumbnail search - Smart search - Replay. For information about PTZ control, refer to the discussion on PTZ on page 136.

To exert PTZ control, first click on this button  to enable PTZ control.

When PTZ control is enabled, the following controls are available on screen:

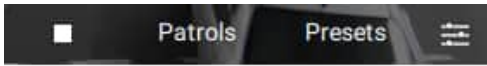

Click Patrols or Presets if these have been configured on the PTZ camera. You will need to open a web console with the camera to do so.

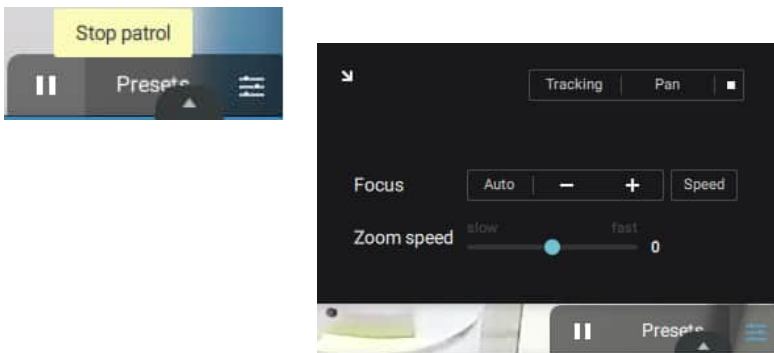

The PTZ settings tab allows you to enable PTZ Tracking and the Pan functions. You can also adjust the Zoom and Focus speed, or manually adjust the focus. Please refer to the camera User Manual for more information about these functions.



For speed dome cameras that comes with wiper blade, the wiper blade control button will be available on the tool bar.

You can use the mouse wheel to zoom in or zoom out on the screen. The zoom ratio is shown on screen for half a second.



When PTZ is enabled, the zoom buttons and a home button are displayed on the right hand side of the view cell.

For more information about Snapshot, Thumbnail search, and the Replay functions, please refer to their specific help pages.

3. **Motorized lens** cameras:



Enable Optical - Snapshot - Thumbnail search - Smart search - Replay.

For cameras that come with motorized zoom lens, click on the Enable Optical button. You can zoom in or zoom out on the scene.

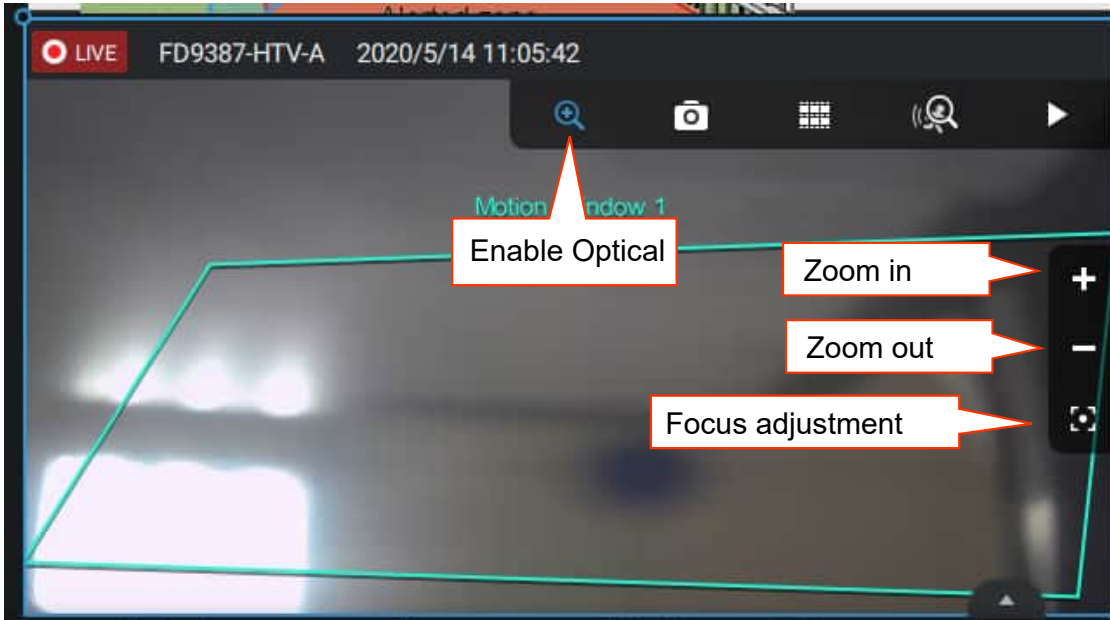

Click on the Focus adjustment button to bring out the focus panel. If you find the image is out of focus, you can use the +, -, or Auto buttons to regain the best image focus.

You can use the Auto scan function to let the camera automatically find the best focus. The process may take up to 20 seconds.

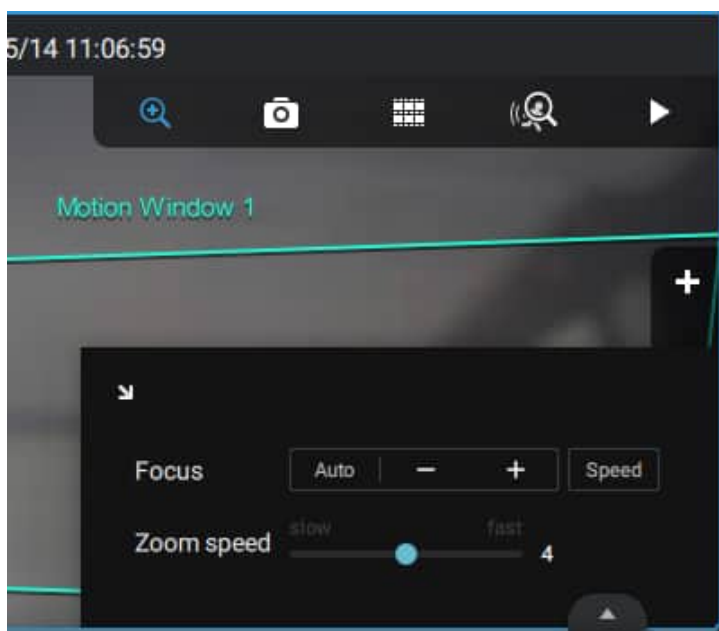

Audio

For a view cell housing a camera with an audio input, you can tune its volume using the slide bar on the tab panel.

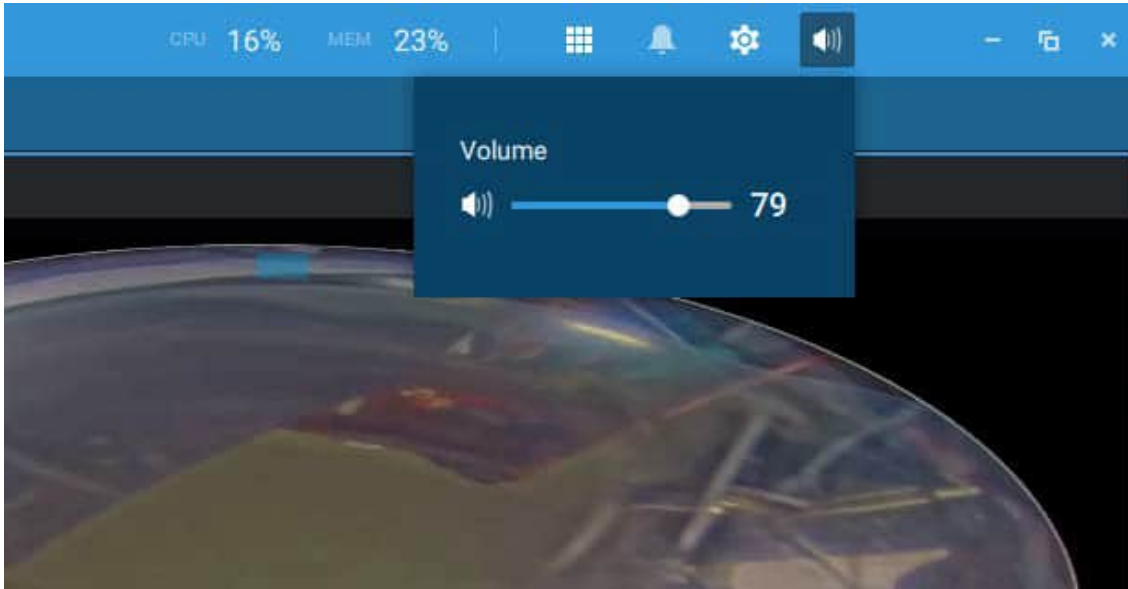

VAST Server and Client Components

VAST2 Server provides a centralized management site for video recording. Users can login and modify the server's configuration, edit the server's recording storage, configure schedules and many other functions. You can browse the recorded video database and video clips related to specific events on the server.

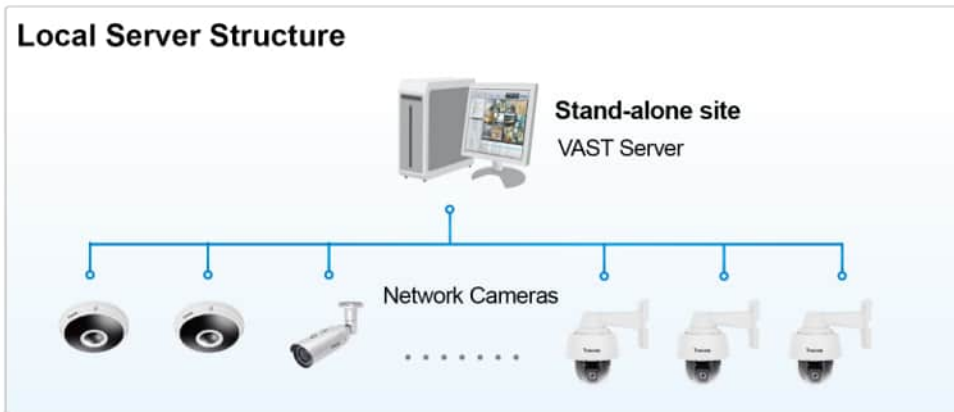

For users who manage large-scale surveillance deployments, please plan the hierarchical structure first. Then you can start to add cameras to each station and connect these sub-stations to the root station. The whole hierarchical management system is thus constructed. VIVOTEK's NVR stations can also be included as sub-stations. The Logical Tree view becomes the default.

Multiple Server Applications

A host with the VAST2 installed is recognized as a stand-alone site. All the functions can be simultaneously performed on one single site.

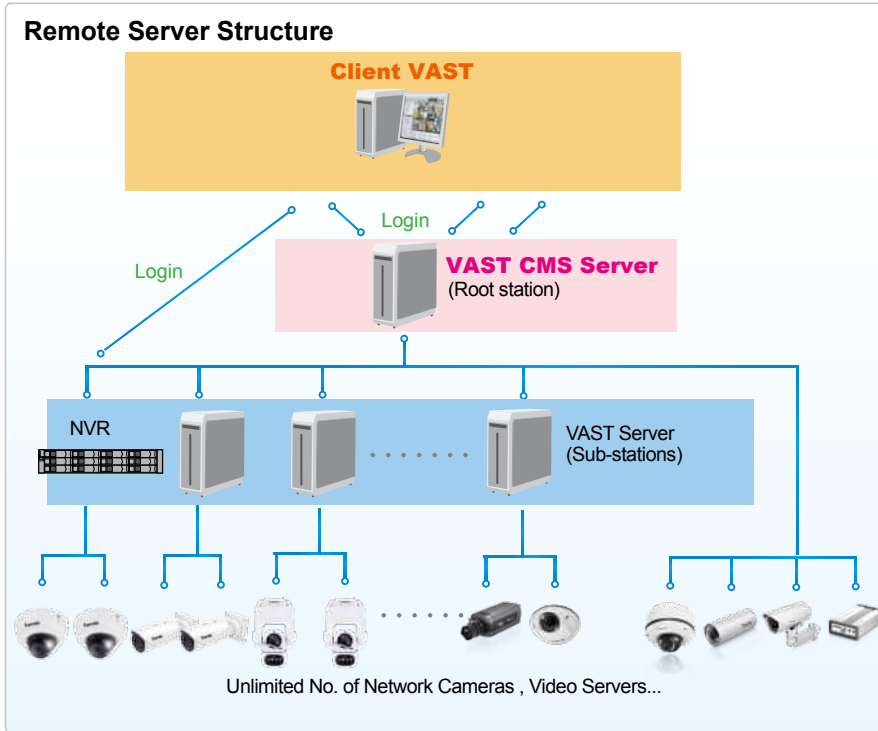

Please refer to the Sites page for how to enlist VAST sub-stations.

Minimum System Requirements

Before installing the VAST software, please make sure your system meets the following recommended minimum system requirements.

VAST2 Server			
Operating System	Windows 10, 7, Windows Server 2012, 2016 (Server core installation type is not supported.)		
Server (Recording Channels)	Up to 64 CH	Up to 128 CH	Up to 256 CH
CPU	6th Generation Intel® Core™ i3 Processors or above		6th Generation Intel® Core™ i5 Processors or above
RAM****	4 GB or above	8GB or above	8GB or above
Hard Drive (Enterprise model only), suggestion	1 Volume Group*	2 Volume Group*	4 Volume Group*
Recording throughput	1 Volume Group: Max. 200Mbps (Max.)**		
Network Interface Card	Ethernet, 1Gbit recommended***		

- * The size of volume group depends on the total recording server throughput.
- ** The maximum combined bit rate of cameras cannot exceed the total recording throughput.
- *** Please consider the combined throughput of viewing, recording, and server's network bandwidth when designing your surveillance deployments.
- **** Please use a dual-channel memory configuration.

VAST 2 Liveview & Playback				
Operating System	Windows Server 2012, 2016 / Windows 10, 7 / MacOS 10.15 Catalina (Server core installation type is not supported.)			
Clients (Display Channels)	720P,2Mbps, H.264,* each CH	8 CH	16 CH	32 CH
	1080P,4Mbps, H.264**, each CH	6 CH	10 CH	18 CH
	1080P,4Mbps, H.265, each CH	3 CH	5 CH	9 CH
CPU	6th Generation Intel® Core™ i3 Processors	6th Generation Intel® Core™ i5 Processors	6th Generation Intel® Core™ i7 Processors	
RAM***	8GB or above	8GB or above	16GB or above	
Network Interface Card	Ethernet, 1Gbit recommended			
Graphics Card****	Direct3D acceleration with 1GB RAM graphics card			

- * Each recording group can receive recordings for 60 channels.
- * Display requirements of the 3MP fisheye camera is equal to a 720P camera.
- ** Display requirements of the 5MP fisheye camera is equal to a 1080P camera.
- *** Please use a dual-channel memory configuration.
- **** Please update to the latest GPU driver.

If you plan to install both VAST2 server and client on the same computer, please remember to consider the combined load on computing, encode/decode effort, and bandwidth.

The 60-day trial includes 256 channel license and all advanced license features.

The required hard disk space will depend on the video settings, the number of network cameras and recording group settings. Please add more hard disks if you want to extend the system.

Below are the approximate numbers for a week-long recording. The actual storage space required also depends on imaging parameters, e.g., a complex retail environment that involves many moving objects requires more pixel data to be transmitted over network than a simple environment such as a parking lot. The following numbers are based on H.264 recording.

32-CH, VGA, about 1 week recording: 750 GB

64-CH, VGA, about 1 week recording: 1TB x 2

32-CH, 2-megapixel, about 1 week recording: 2TB x 2

64-CH, 2-megapixel, about 1 week recording: 2TB x 4

Chapter 2-2 Starting Up

Double-click the VAST2 icon  on the desktop to start the VAST2 main page.

When started the first time, the server automatically polls the local network for reachable network cameras. For cameras that come with pre-configured User Name and Passwords, the server prompts for entering credentials for the access to cameras. Check out the cameras' MAC addresses to identify the cameras.

The cameras found within the network will be listed. If the need should arise, you can use the Search panel on top to locate specific cameras using their IP, MAC, Port, Model name, or brand name (ONVIF/VIVOTEK).

Use the  Add device button to manually add a camera with its known IP or domain name.

Use the  Import Device List button to recruit cameras in a previously-saved device list (CSV files).

Use the Authorize button if the camera found in the Search panel needs credentials.

When search is done, delete the alpha-numeric characters in the search field to return to the device list.

Use the Refresh  button to search the local network again.

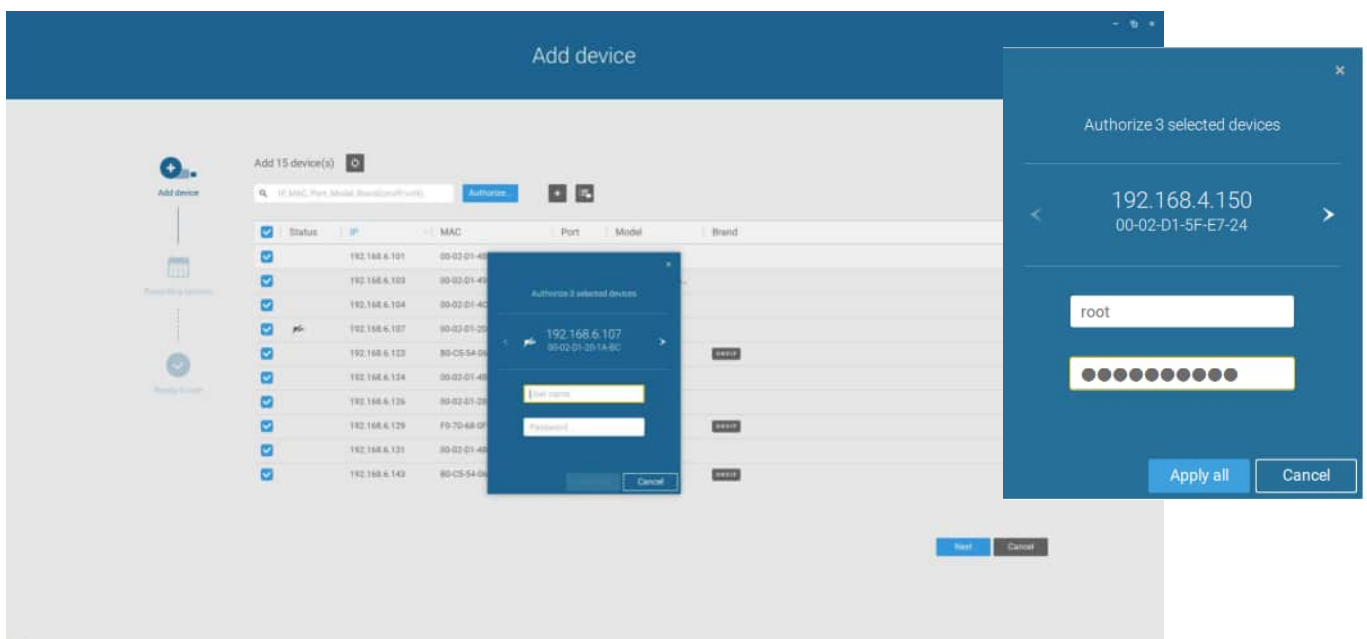

2-2-1. Selecting Devices

Use the checkboxes in front of the listed devices to determine which devices will be recruited to your configuration. By default, all cameras are selected. When the selection is done, click on the Next button at the lower right screen.

If any of the selected devices requires credentials, the authorization window will prompt.

NOTE:

For cameras that come without a password protection, you should open the Shepherd utility to locate and open a web console, and configure a password for protecting the access to the camera. If a brand new camera (with no password) is selected for your VAST configuration, it will join your configuration without the password protection.

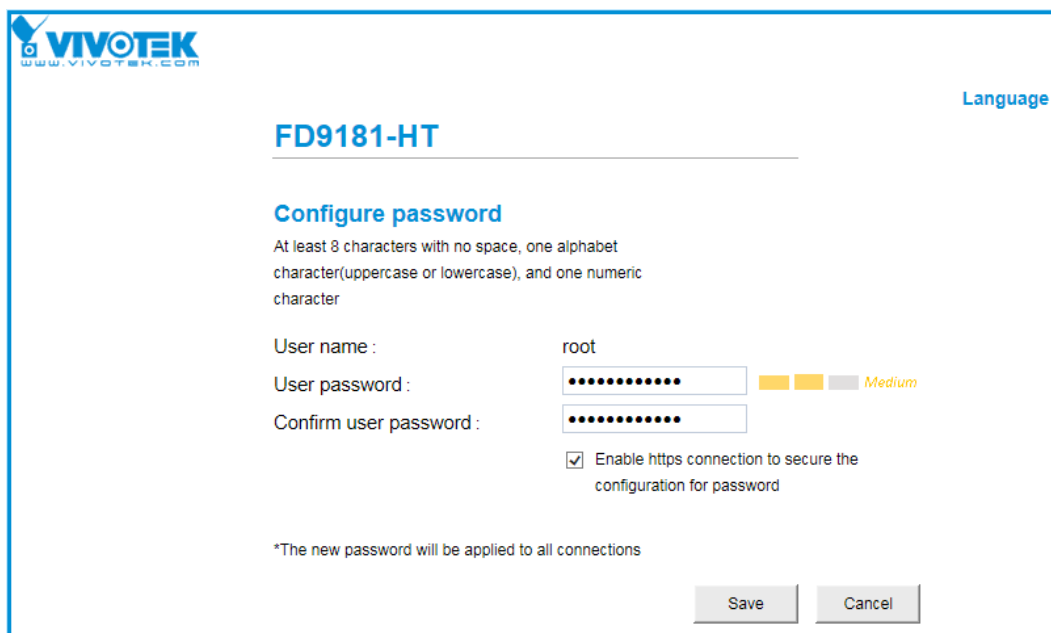

VIVOTEK
www.vivotek.com

Language

FD9181-HT

Configure password

At least 8 characters with no space, one alphabet character (uppercase or lowercase), and one numeric character

User name : root

User password : Medium

Confirm user password :

Enable https connection to secure the configuration for password

*The new password will be applied to all connections

Save Cancel

2-2-2. Recording Options

Click Settings > Recording > Recording options. The Recording options window will prompt.

You can configure recording schedules or select the storage options, including the configuration of an external NAS storage.

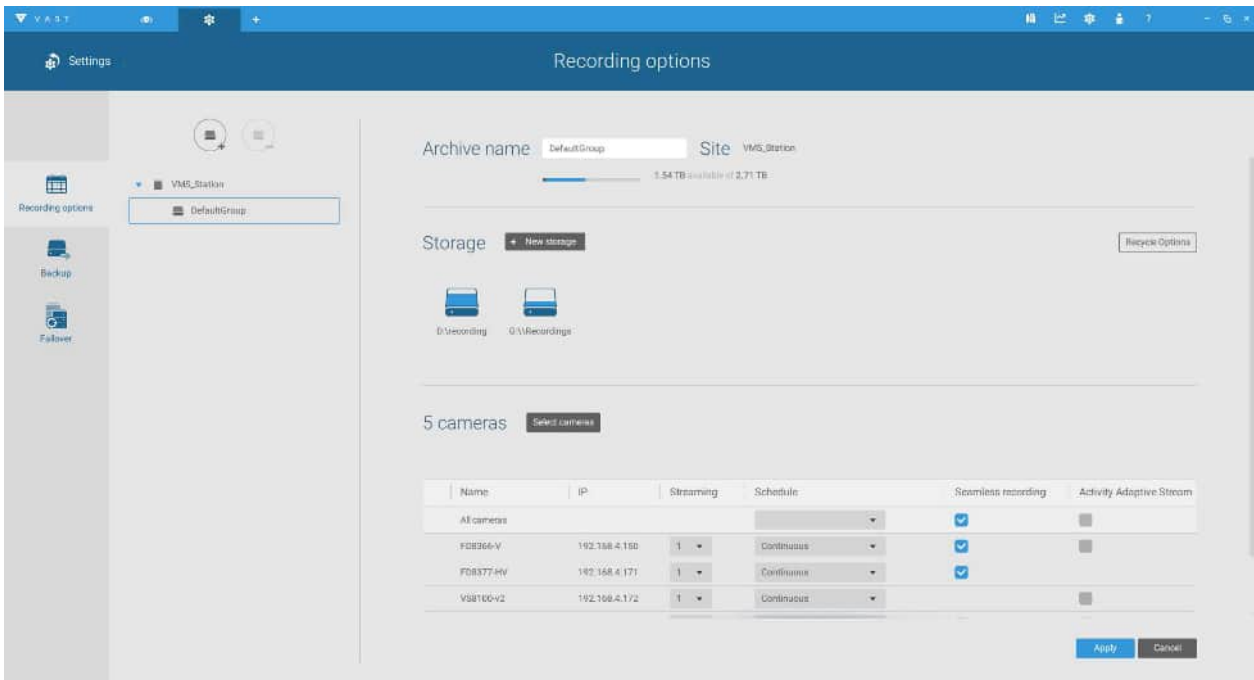

Click on the Schedule column on the Camera list for a recording option: Continuous recordings, Events only, None, or Default Schedule, or New template. You can apply a schedule template for all cameras or configure individual schedules for different cameras. When using the Event-triggered recording, a pre-event and post-event time can be configured. An Edit pane is available by clicking the Edit  button.

You can manually create a recording template using the **New template** option. When done, each configured template will be listed below.

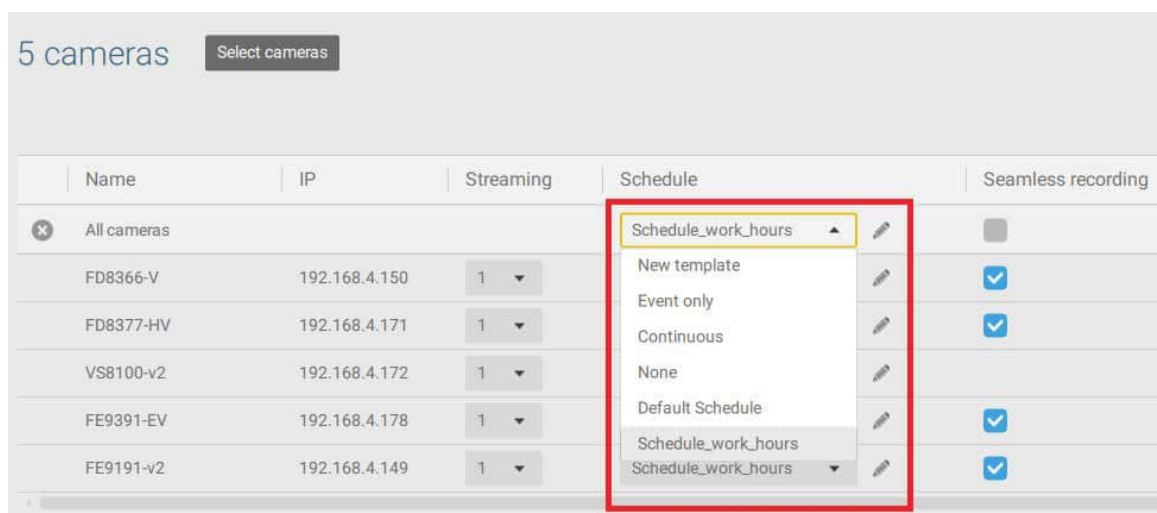

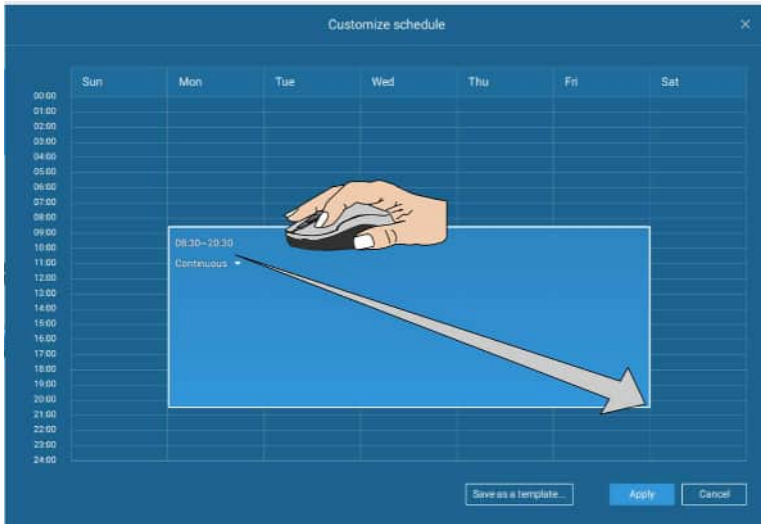



Click and hold down on the time cells, and drag the mouse to include the time span of your preference. The minimum selectable unit is half an hour. You can select separate and multiple time spans on the template.

Enter a name for the template, and click Add to save your template.

The same configuration window apply to both the Schedule template and the customize schedule windows.

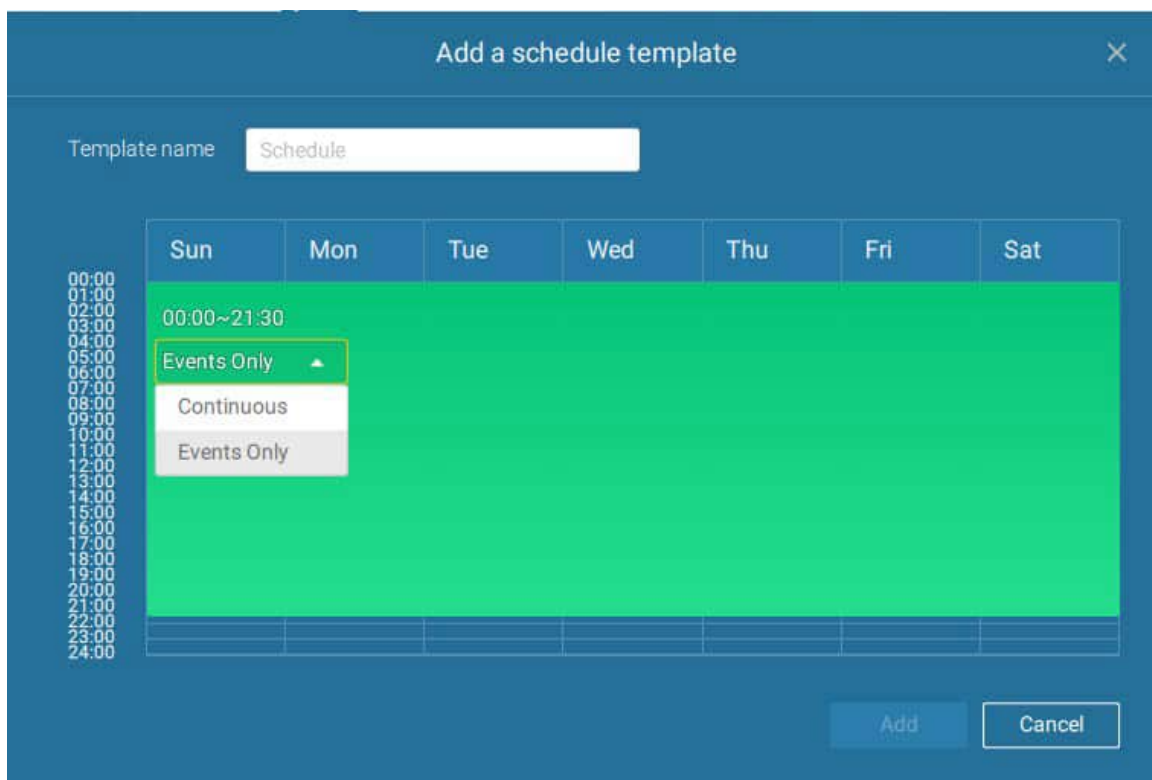
If the **Events only** option is selected for the new template, you can determine what kinds of events will trigger the recording. Use the pull-down menu to select Events only.



When Events only is select, click on the  Settings button to proceed.

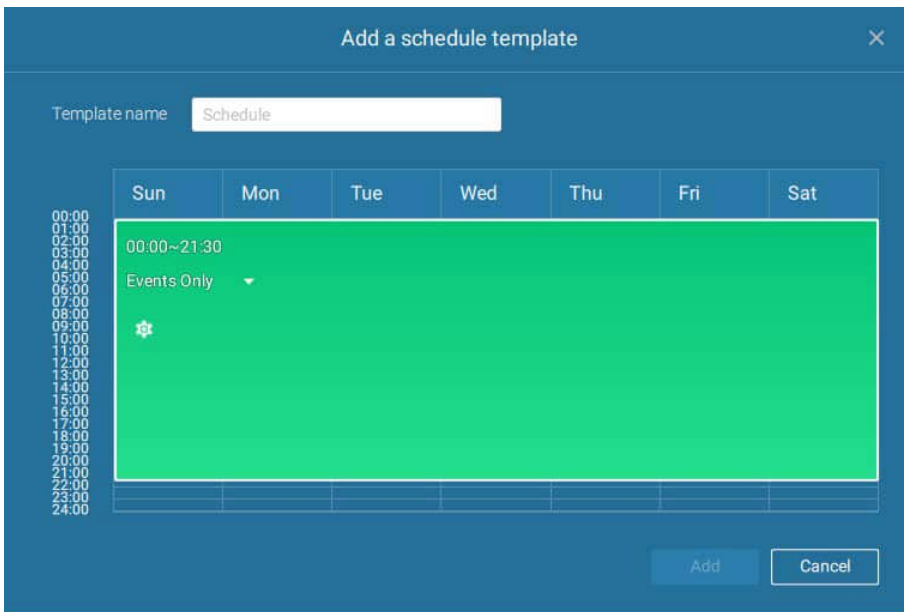

The applicable event types will be listed. Select the types of event triggers that you prefer. Click **Apply** to leave this page. By default, all applicable event triggers will be selected.

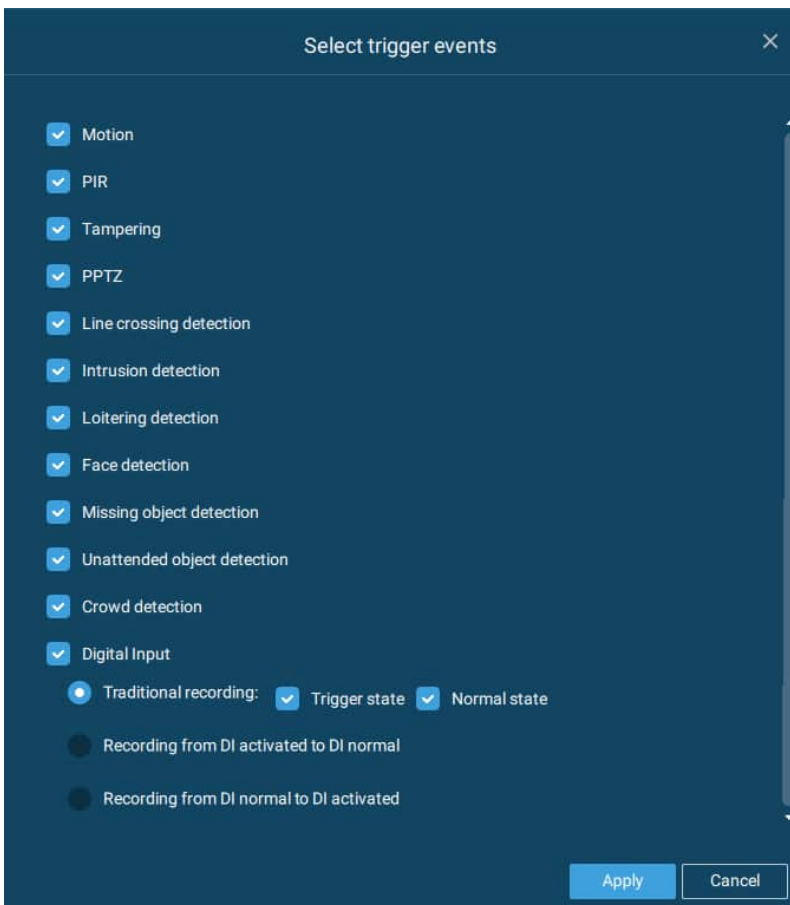

Back on the Recording options page, select the new template as a scheduling option. Use the menu on the top to select a scheduling template for all cameras.

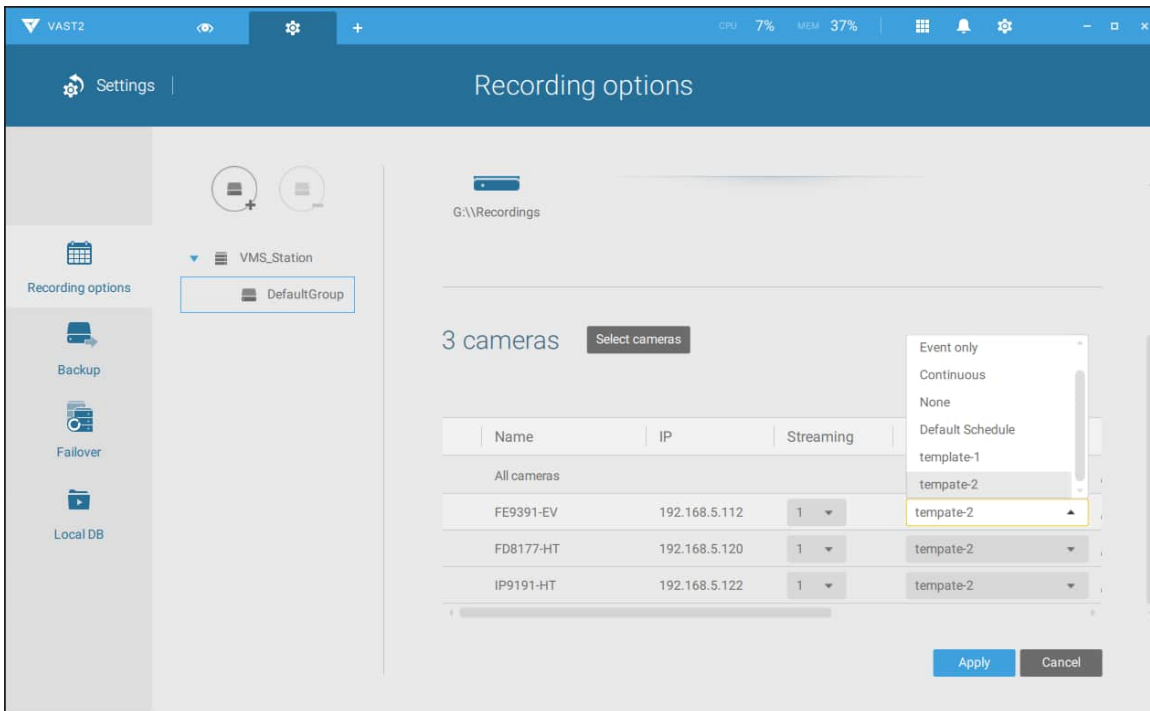

Make sure a Schedule mode is selected when you leave this configuration step.

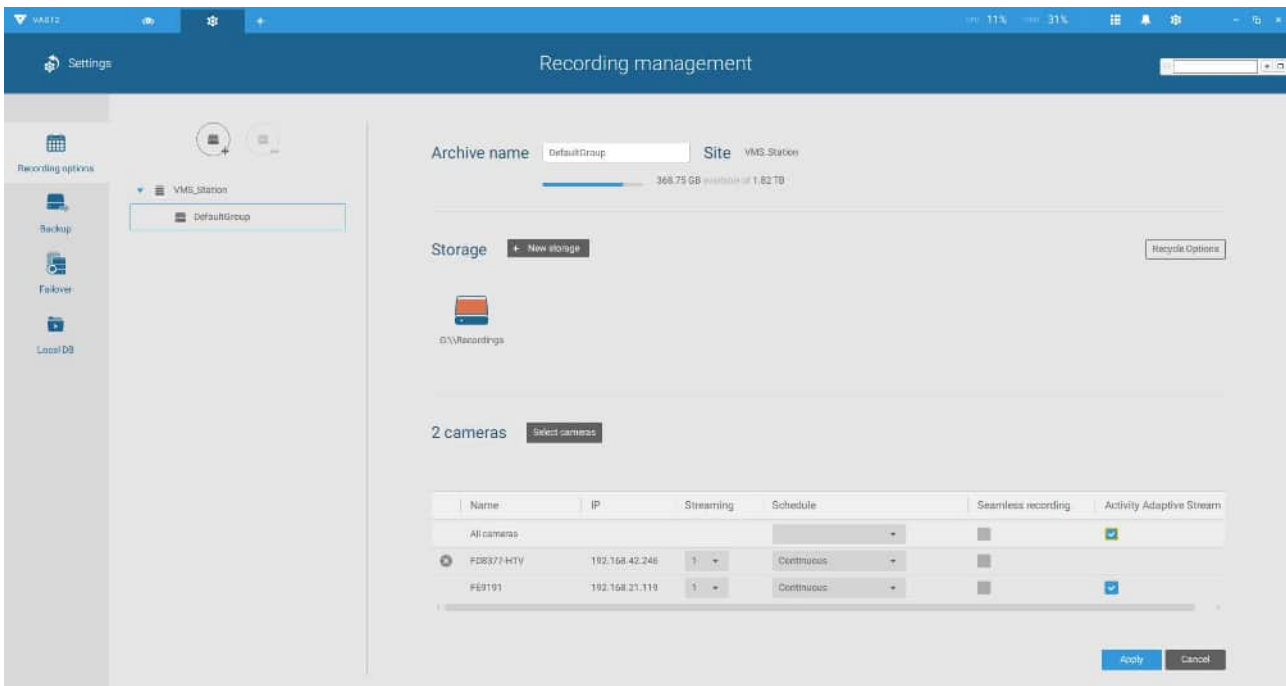

Seamless Recording

Seamless Recording safeguards critical videos in the occurrences of network disconnection.

In the event of temporary disconnection, video is stored in individual cameras' SD/SDHC/SDXC card; and once the connection is restored, a VAST server can automatically resume the recording. More remarkable is that, a VAST server can simultaneously retrieve the time-tagged videos that were temporarily stored on SD/SDHC/SDXC cards. For information about the latest firmware/software revisions that support this feature, please contact your sales representatives or technical support.

Seamless Recording

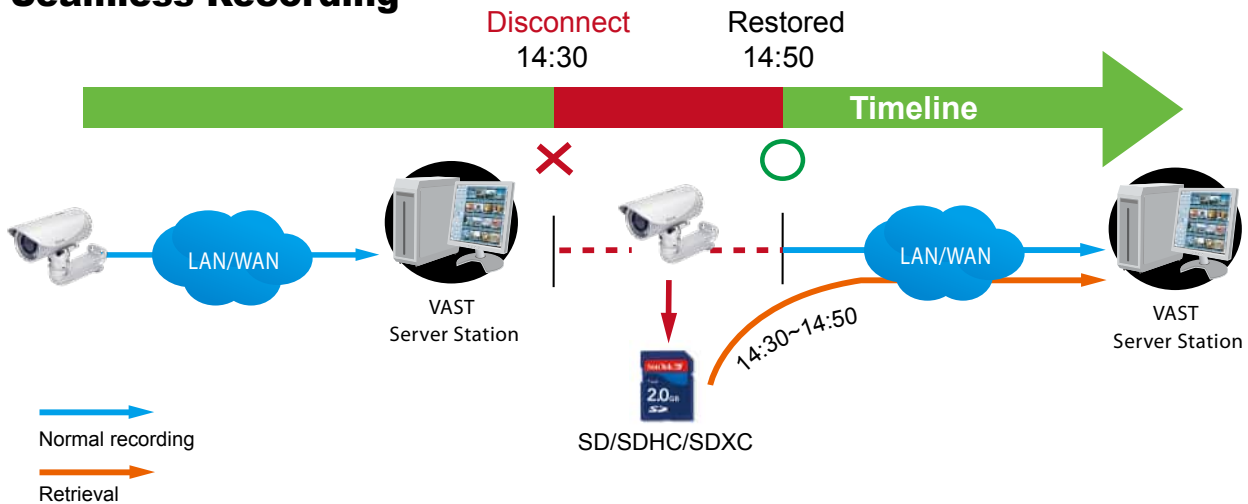

The video data retrieved from SD/SDHC/SDXC card also include event-triggered recordings such as pre- or post-event footages, if events were detected during the network outage.

The Seamless Recording feature is enabled when inserting, updating, or batch inserting cameras in the Camera Management window. The firmware/hardware compatibility of this feature is automatically detected, i.e., this feature is not available when a non-compliant camera is attached. If a compatible camera is attached, a checkbox will be available as shown below.

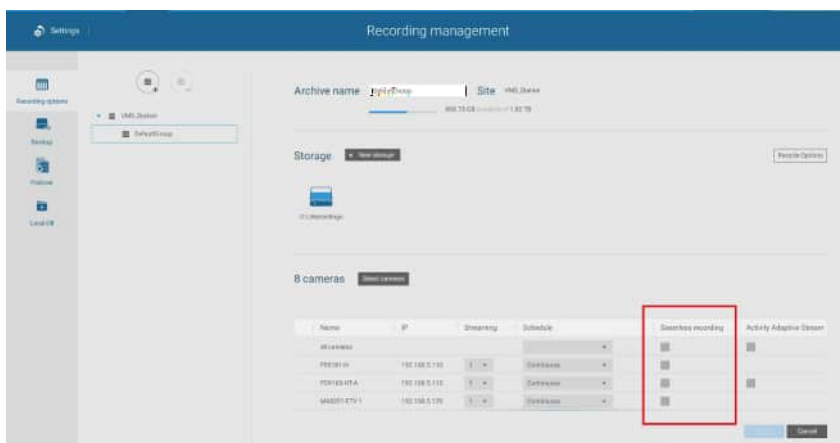

Activity Adaptive Stream

- Activity Adaptive Stream: (Note that this feature may not be available for some older models)

This option will activate the frame rate control according to alarm trigger.

The frame control means that when there is a triggered alarm, the frame rate will raise up to the value you've configured on the Video quality page.

If you enable adaptive recording on a camera, only when an event is triggered on a camera will the server record the full frame rate streaming data; otherwise, it will only request the I frame data during normal monitoring, thus effectively saves bandwidth and storage space.

The alarm trigger includes: motion detection and DI detection. Please refer to Alarm Settings on page 145.

On individual cameras, you can configure the following:

- Pre-event recording and post-event recording
The Network Camera has a buffer that temporarily holds data for a period of time. Therefore, when an event occurs, the camera can retrieve image frames taken several seconds ago. Enter a number to define the duration of recording before and after a trigger is activated.
- Priority: Select the relative importance of this recording (High, Normal, or Low). Recording with a higher priority setting will be executed first.
- Source: Select a video stream as the recording source.

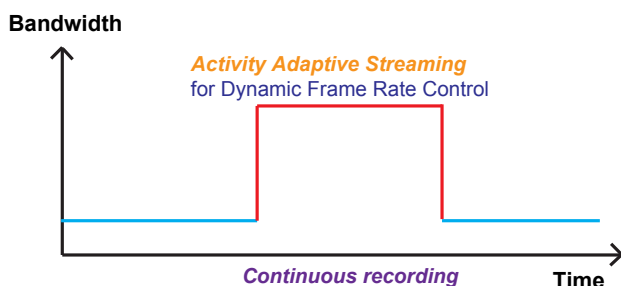
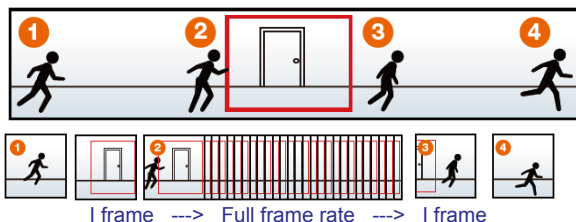

NOTE:

- * To enable adaptive recording, please make sure you have configured the trigger sources such as Motion Detection, DI input, or Manual trigger.
- * When there is no alarm trigger:
 - JPEG mode: record 1 frame per second.
 - H.264 mode: record the I frame only.
- * When the I frame period is > 1 second on the Video settings page, firmware will force decrease the I frame period to 1 second when the Activity Adaptive Recording feature is enabled.



Adding NAS (Network Attached Storage) as a Storage Option

You can also record videos to a networked storage.

1. Click the Add archive  button.
2. Enter a name for the configuration.
3. Click the Add storage  button.

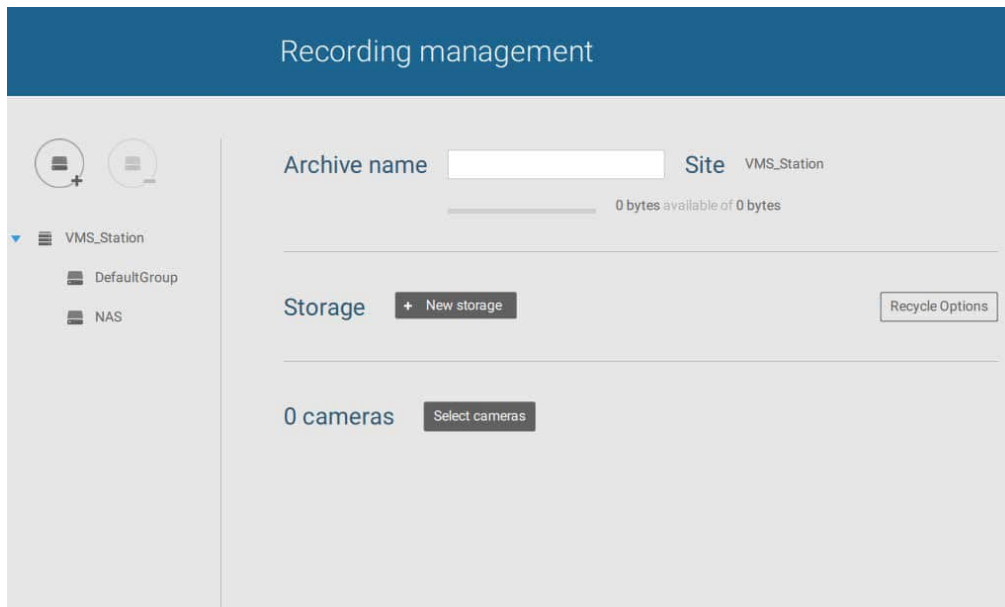

4. Click the + New NAS button.

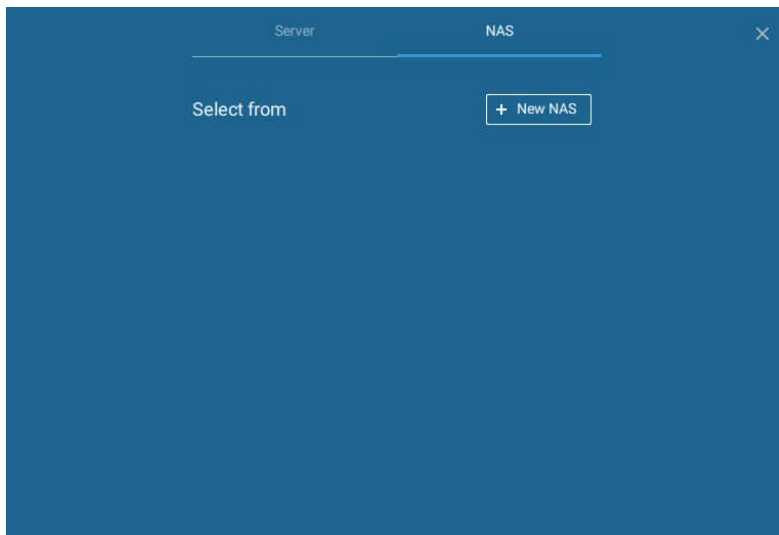

5. Enter the NAS storage's address and the credentials for access to the networked storage. When done, click the **Connect** button.

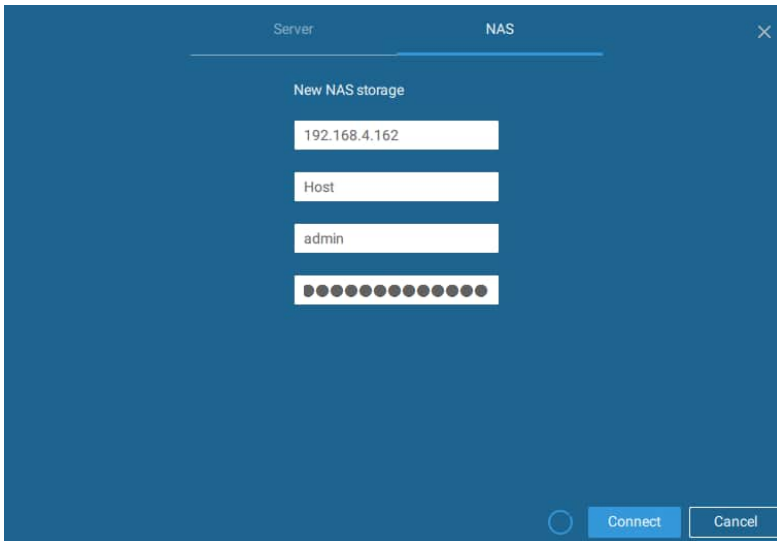

6. The NAS storage should appear on screen. The connection may take several seconds. Single-click on the NAS storage to select its network shares.

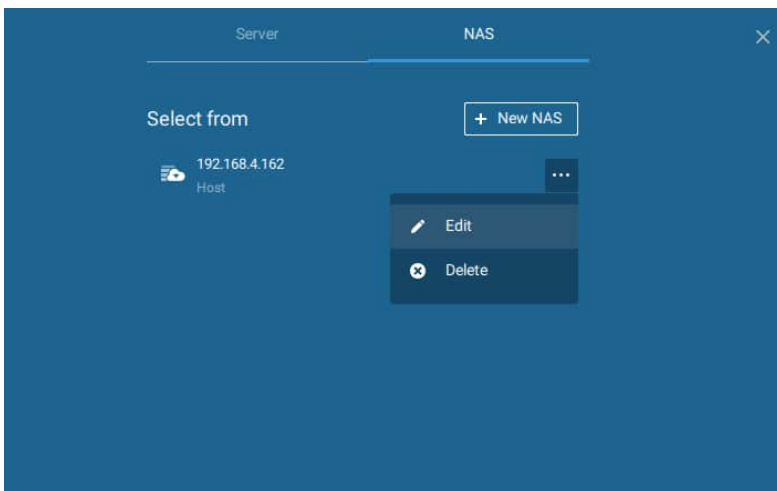

7. The NAS storage's network shares should be listed. Single-click to select a network share.

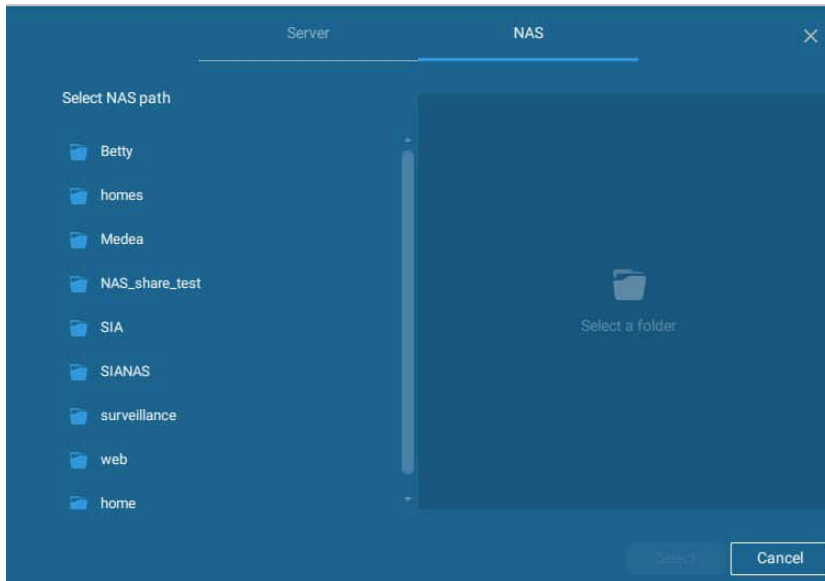

8. Click **Select** when done. Note that you can repeat the previous process to select multiple network shares from a single NAS storage.

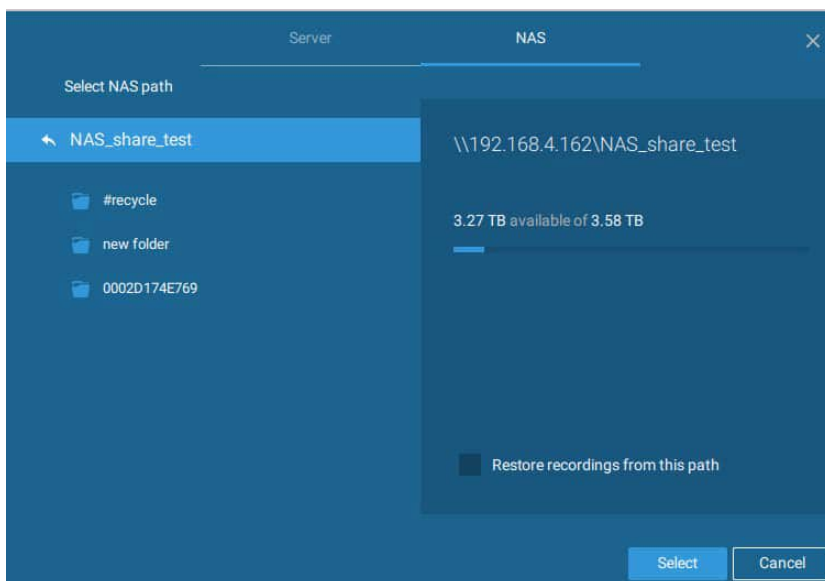

- The selected shares should be listed. Enter a name and select cameras. When done, click the Add button at the lower right to complete your configuration.

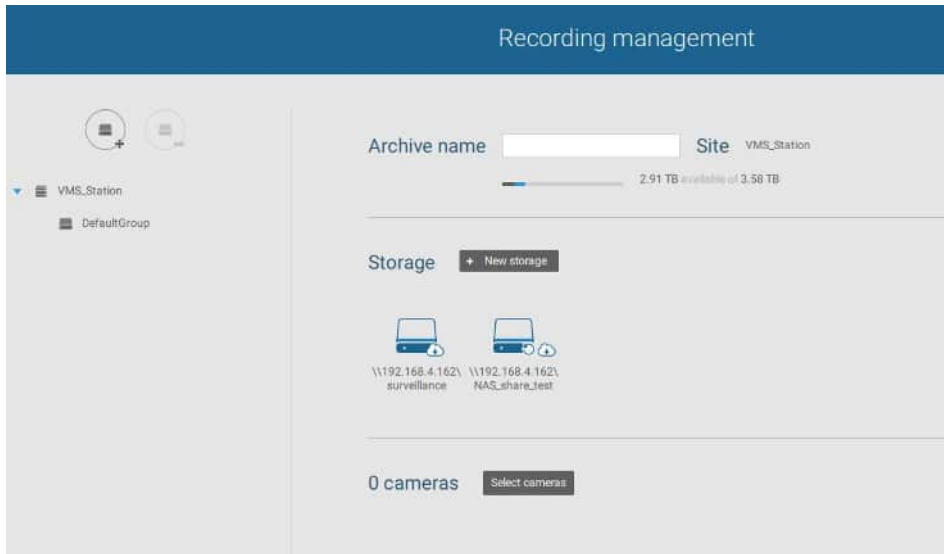

2-2-3. Storage

By default, VAST will check if the D: drive is available. If no other disk drives can be specified, the system drive C: will still be defined as a storage option. Other disk drives in the system, and the default storage volume (configured in the initial setup) will be listed.

You can add a NAS storage's share volume as the additional storage option. Enter the necessary information for access to a network share. Enter and select a NAS path. The share will then be available for video recording.

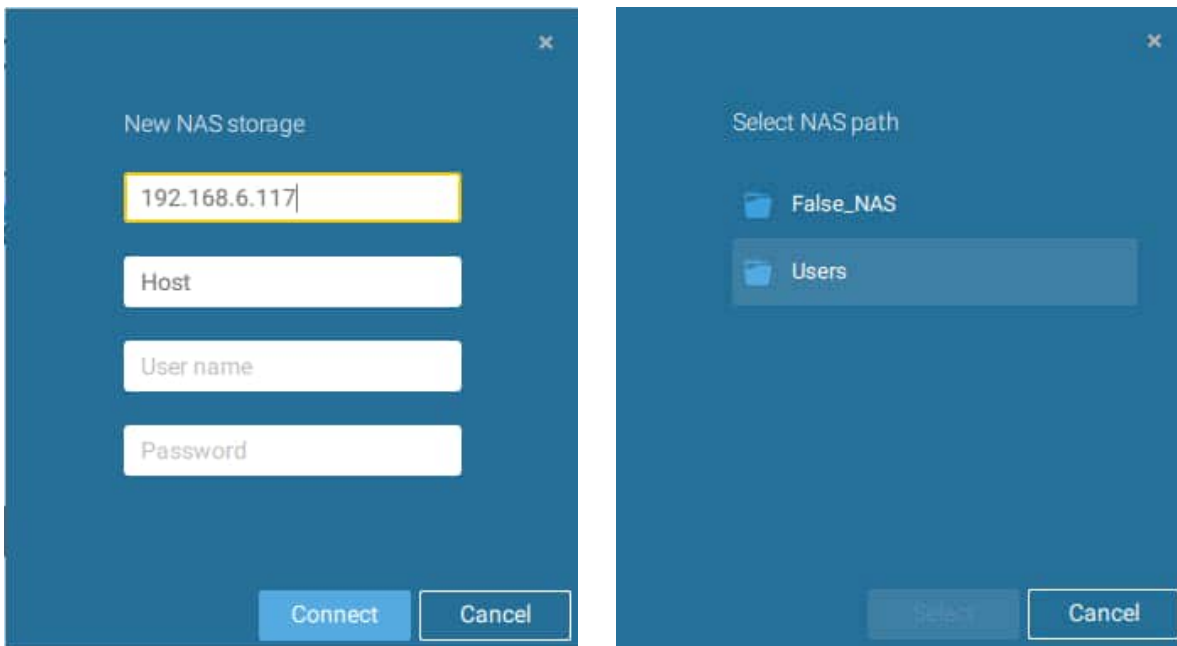

Select storage volumes each by a single click.

Click **Ready to use** to continue. The server will take several minutes synchronizing configuration between server and cameras, and time settings between them.

2-2-4. Starting Up - Main Page

You will be defaulted to the Live view once the main page displays. Another tab window is the Search panel where you can search recorded events and recorded videos.

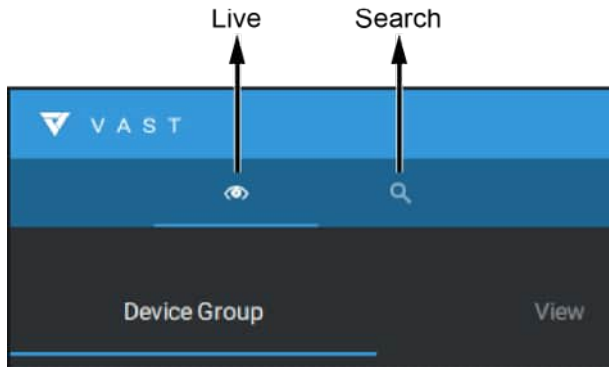

On the initial start up, the server should fill the live camera feed to the available 2x2 view cells (4). You should then select a preferred layout, e.g., 3x3 or others, using the Layout pull-down menu.

The available layouts are categorized into 4 types: Equal, Panorama, Focus, and Vertical.

Equal: 1x1, 2x2, 3x3, 4x4, 5x5, 6x6, 7x7, 8x8.

Panorama: 1P(Panoramic)+6, 2P, 2P+3, 3P. (applies to fisheye cameras)

Focus: 1+12, 1+16, 1+3, 1+5, 1+7, 1+9, 2+8.

Vertical: 1V+6, 2V+2, 2V+3, 3V, 3V+4, 4V, 4V+4, 5V. (applies to corridor view)

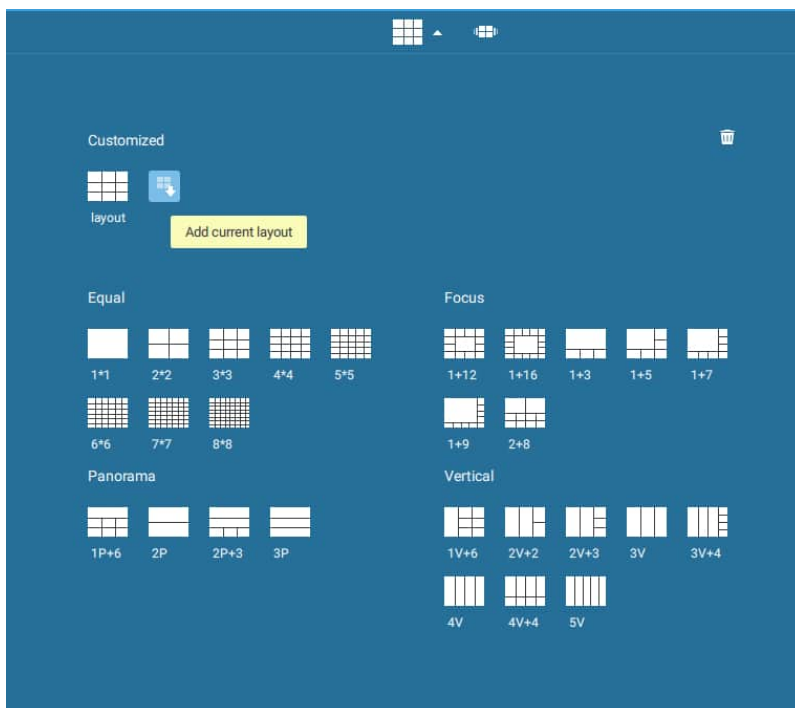

To design and customize a layout, please refer to the [Customizable Layout](#) page.

You can then fill in the view cells by dragging and dropping cameras into the view cells. While dragging, a name tag displays. All cameras should be listed under the VMS_Station Device Group.

You can swap two view cells by dragging one on top of another.

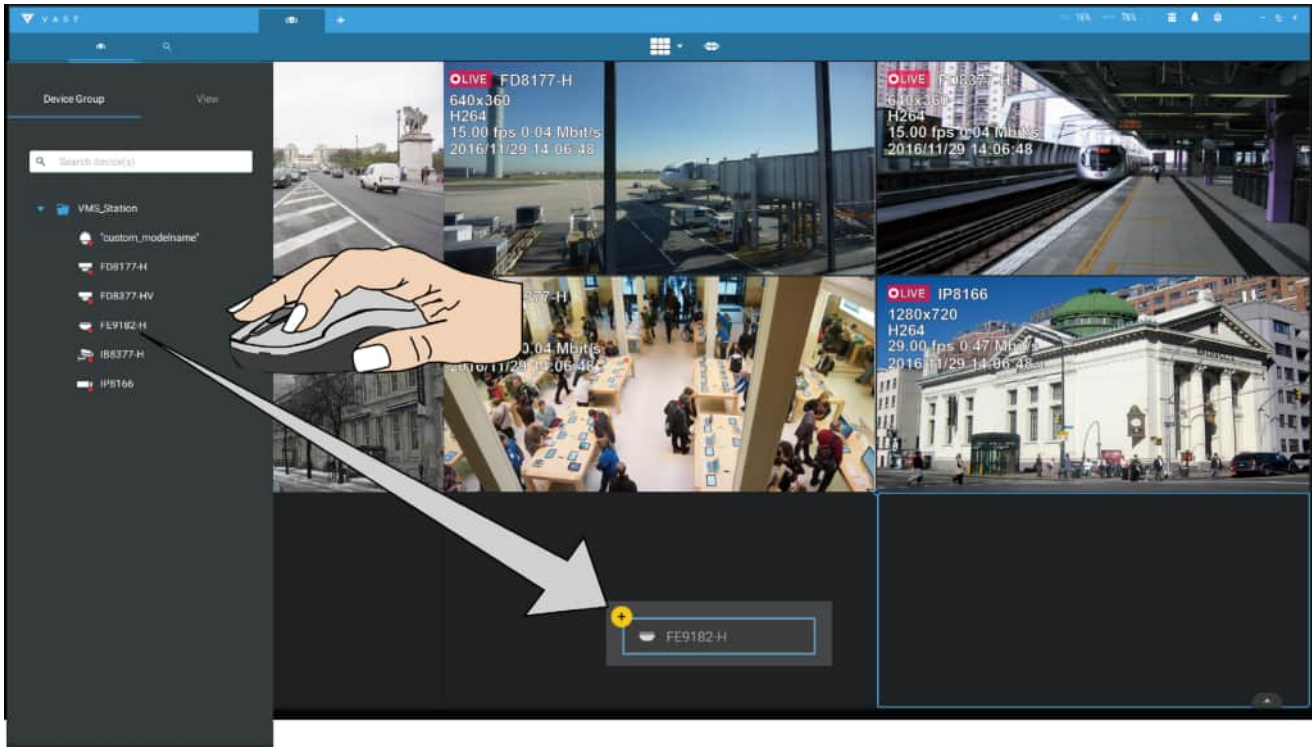

You can also fill in an Emap by dragging and dropping a pre-configured Emap into a specific view cell. Click on the E-Map tab to select a pre-configured E-Map. Note that an E-Map should be placed into a larger view cell.

Depending on the resolution of your monitor, a view cell can be too small for an E-Map. For example, for an HD monitor (1920x1080), a single view cell from a 3x3 layout will have a resolution of 640x360. View cells larger than 330 (width) x 300 (height) pixels can contain an E-Map.

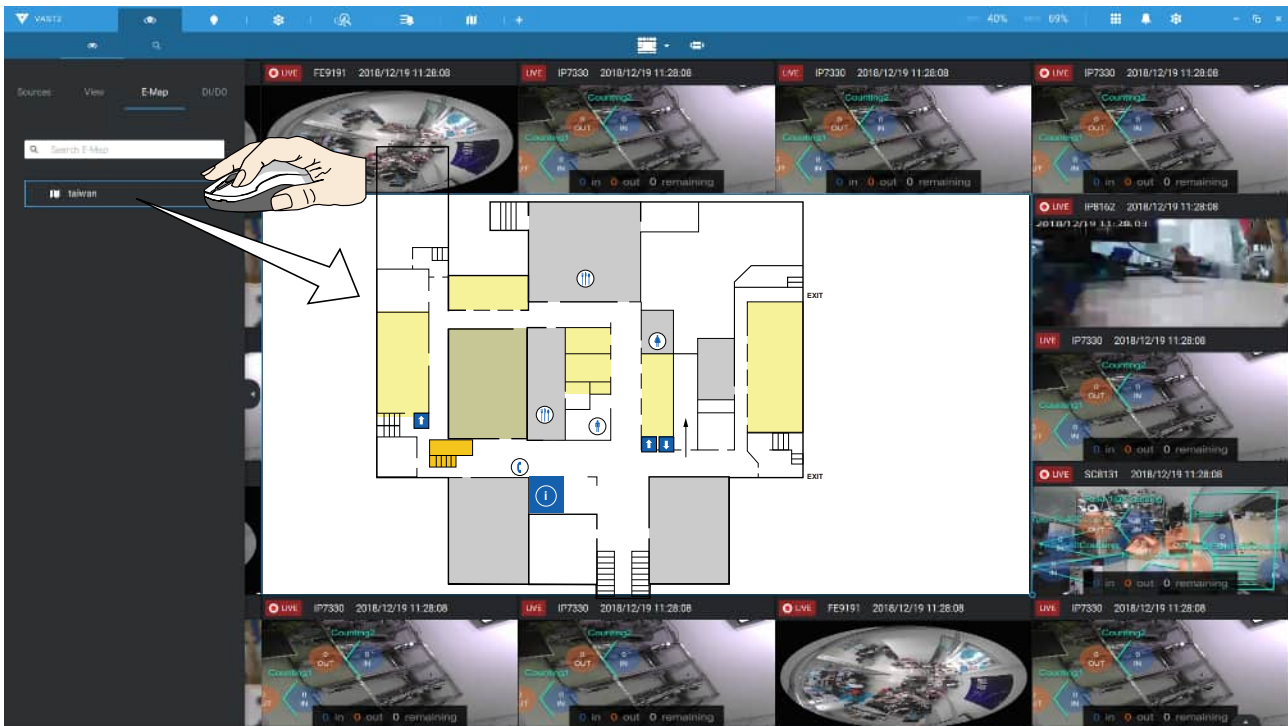

2-2-5. Saving a View

When done with arranging view cells, click the View tag.

Save your current layout and view cell arrangement as a new view.

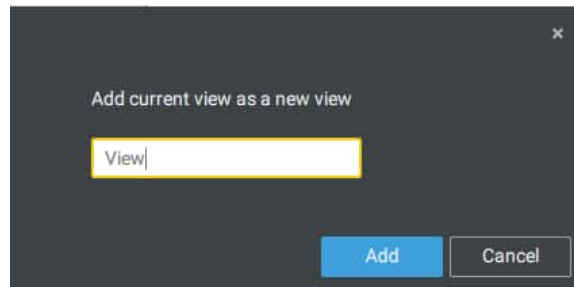
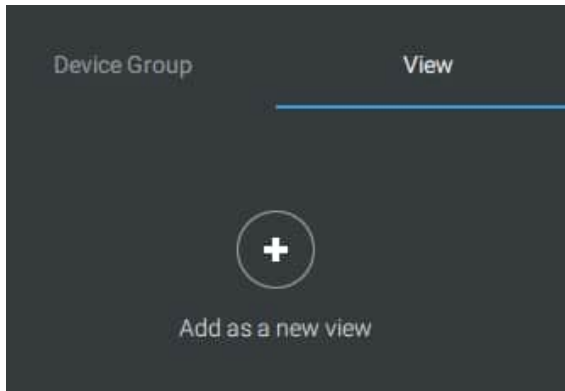

2-2-6. Add More Live Views

With many cameras in your deployments, you can click the New Tab "+" button to add more Live views.

An empty live view will display, and you should repeat the above process to select a layout, and fill in the view cells. When done, save the view.

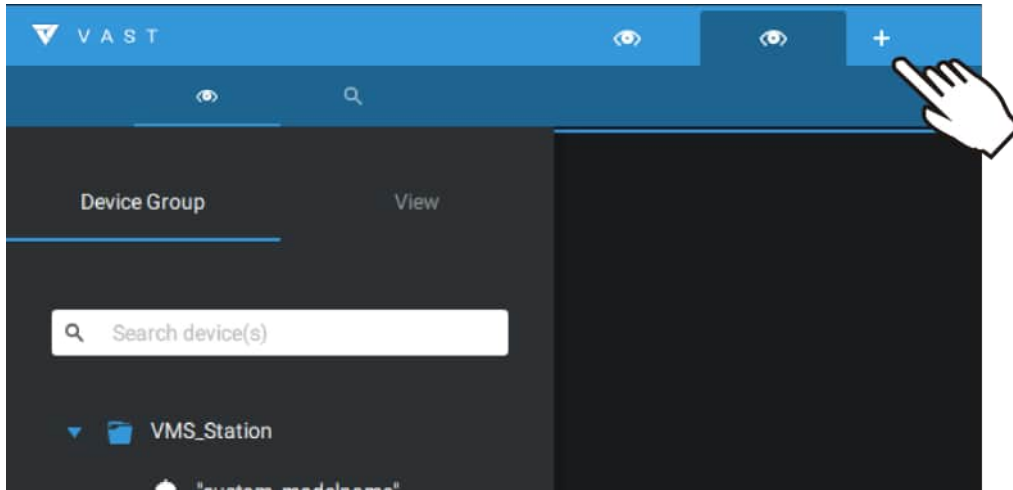

Right-click on the screen to display the right-click menu. Select **Add a view**.

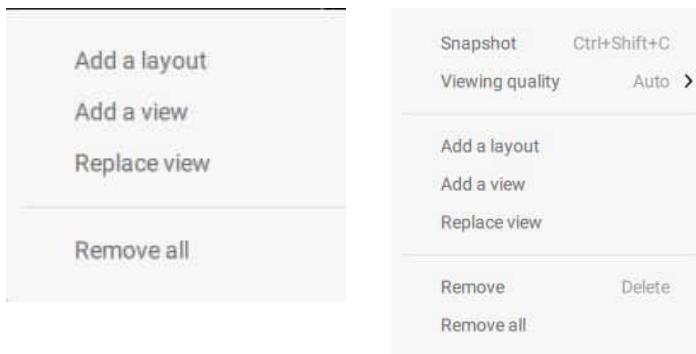

Enter a name for the new view and click **Add** to proceed. The new view will be listed in the View panel.

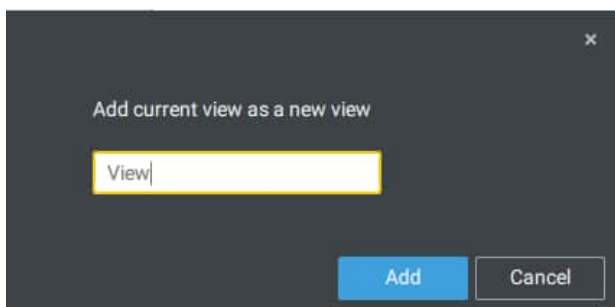

If you have multiple monitors attached to your server station, you can drag a live tab to a different screen. In this way, you can display live views simultaneously on multiple screens.

Live views can be placed on up to 8 monitors. Please note that this is determined by the capability of your graphics card chipset.

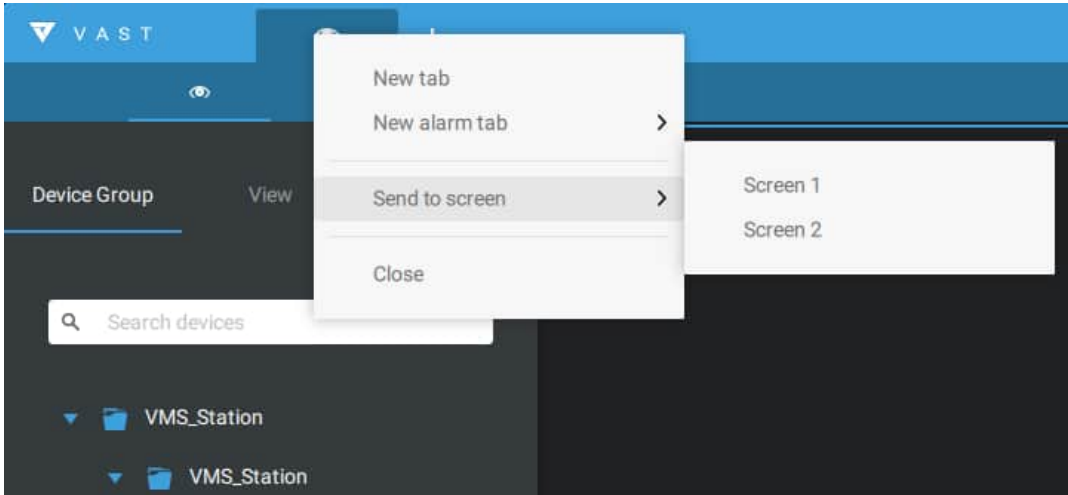

2-2-7. Save Your Preferences

Go to **Settings**  > **Preferences** to save your current layout and display configurations.

Select the options in the startup choices menu to decide what to display whenever your VAST2 client starts. You can display Live view, Tour, Dashboard, E-Map, or Alarm tab simultaneously on multiple screens.

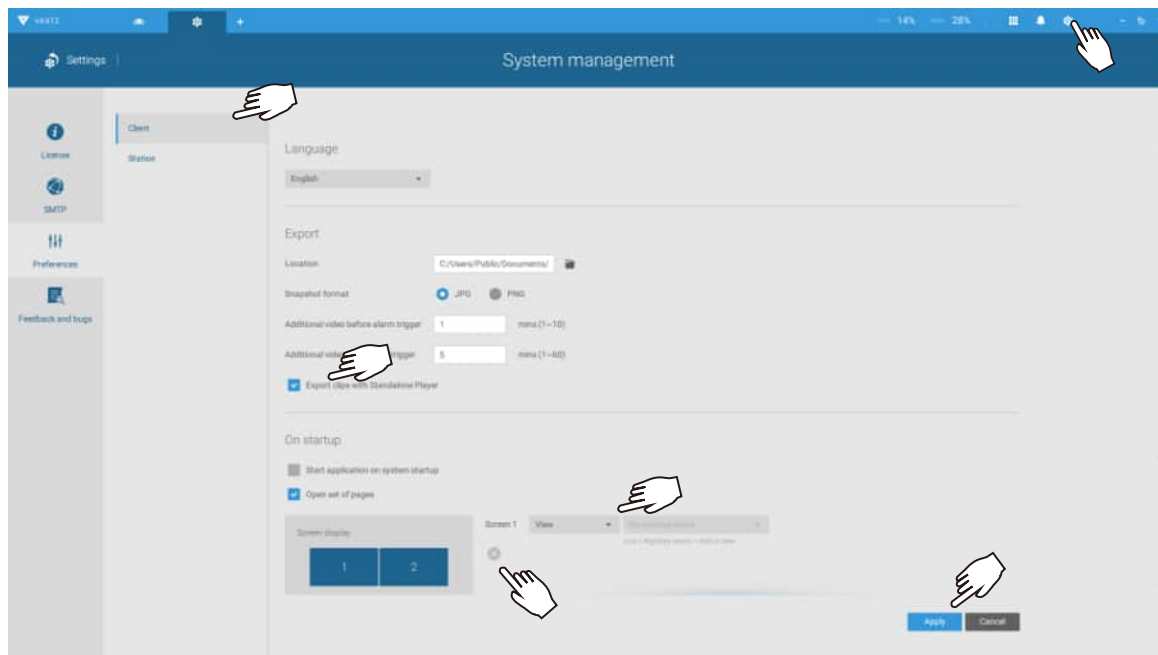



2-2-8. Customizable Layout

The standard layouts can be manually configured to form layouts of your choice. Depending on the complexity of your design, you should start with a multi-cell layout.

Click and drag the corner mark on a view cell. Drag across the screen and release the mouse button to enlarge the view cell. Choose a standard layout of many view cells, e.g., 7x7 or 8x8, if you want to design a complex customized layout. You can create a special layout, e.g., an especially wide view cell for a multi-sensor camera, such as the panoramic MS-8392.

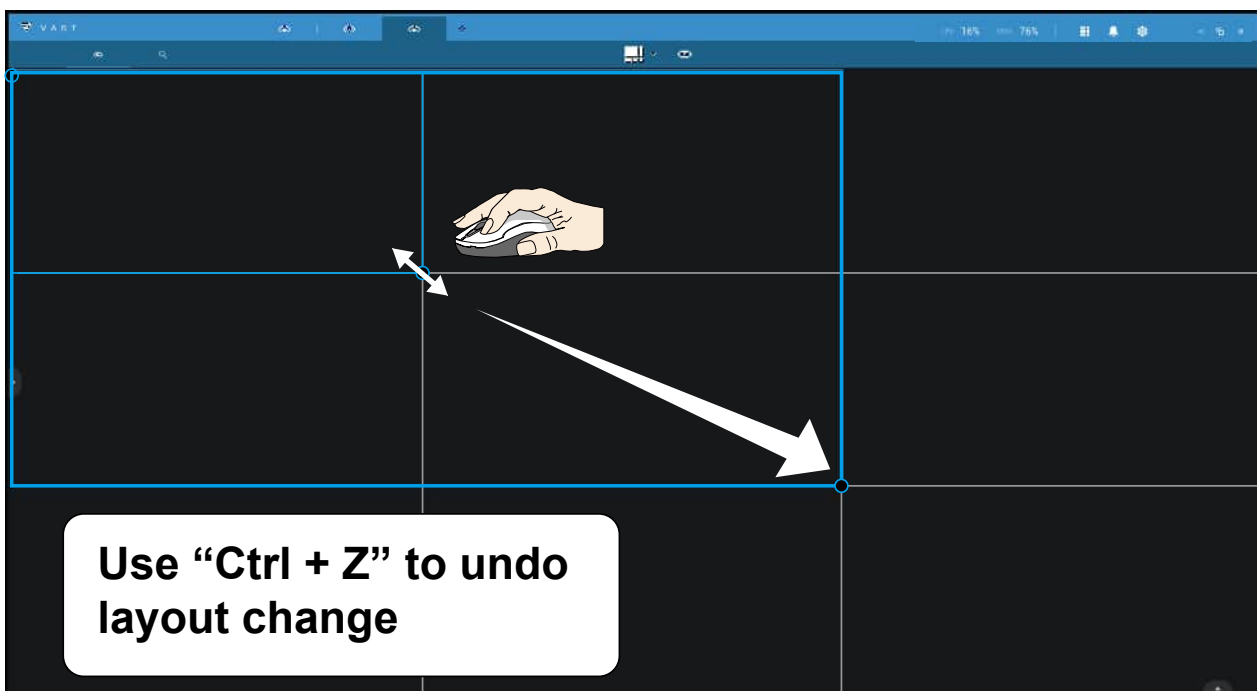
To abandon a customized layout, simply select a new layout from the layout window. You can also use the Ctrl + Z keys to undo your changes on the layout.



To preserve your customized layout, click to open the layout window. Click on the Add current layout  button. You may then change the name of your layout by a double-click on its name. To remove a configured layout, drag it to the garbage can icon on the upper right.

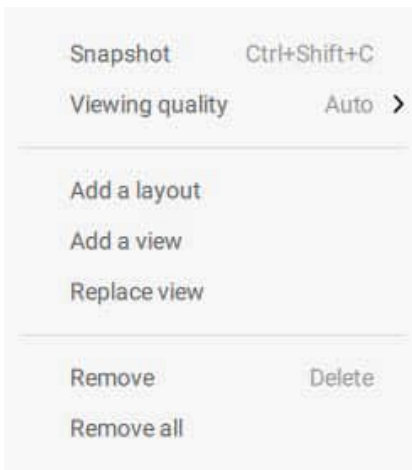
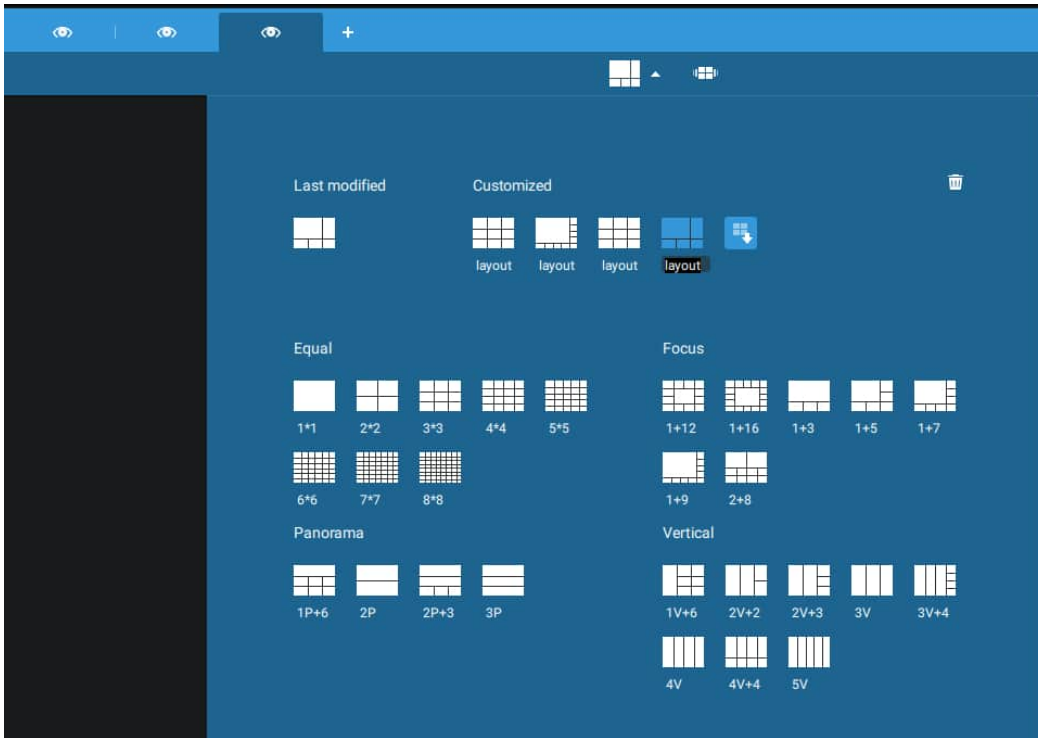

You can also right-click on the screen to display the **Add layout** option. You can then click Device Group, and start filling your customized layout with camera views. When done, click **Add a view**.

Also remember to save the current layout as a view, and save your configuration in **Settings > Preferences**.

2-2-9. Dashboard

Select to open the Dashboard utility from the tool bar. The Dashboard displays the system resources of a CMS server along with those of its sub-stations. This provides a glimpse of the load on machines when performing the recording and monitoring tasks.

Mouse over the edge of the bottom row to reveal the expansion mark. Pull the status row up to display the system resource statuses.

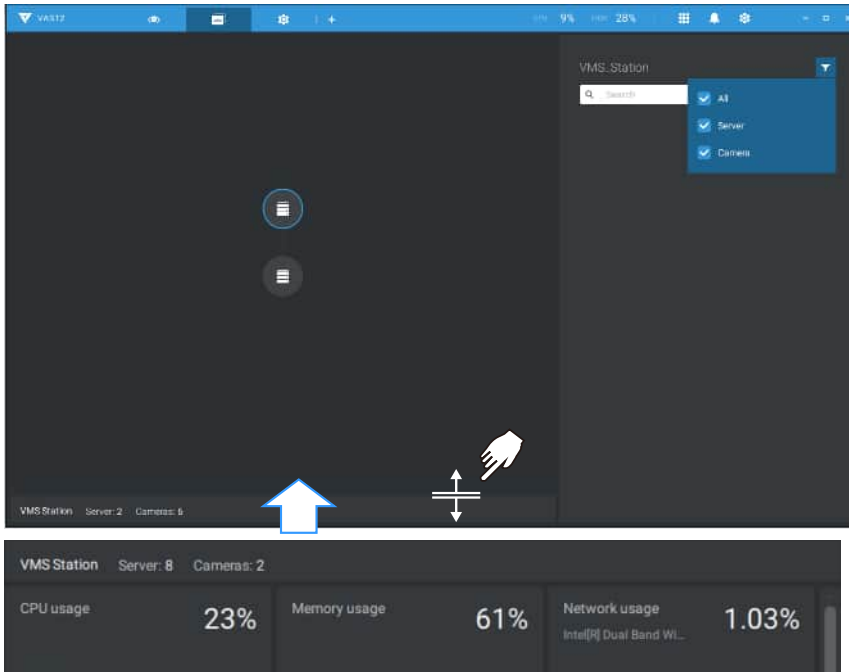

If you have multiple LAN cards or virtual HBAs, the status row can be pulled to reveal all of their statuses.

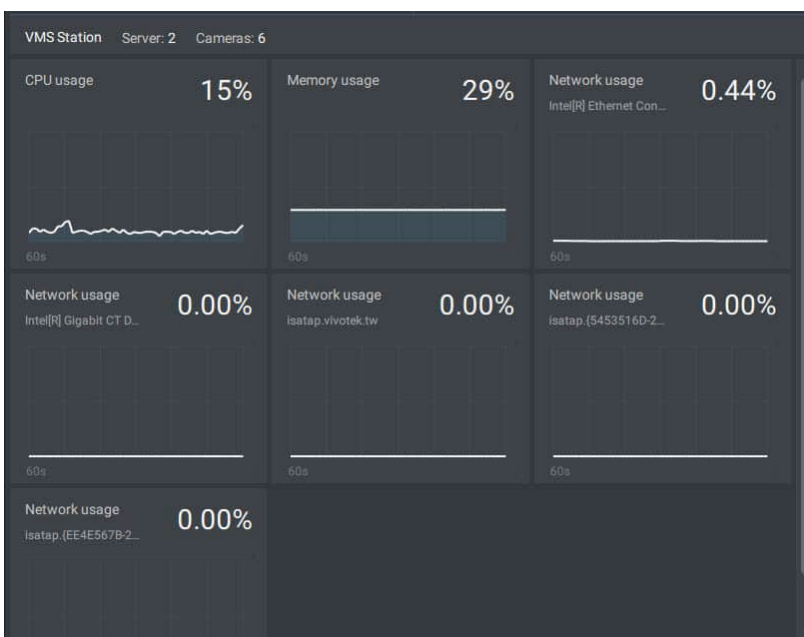

If you have multiple sub-stations, single-click to select and reveal their individual status, including CPU usage, memory usage, and network usage.

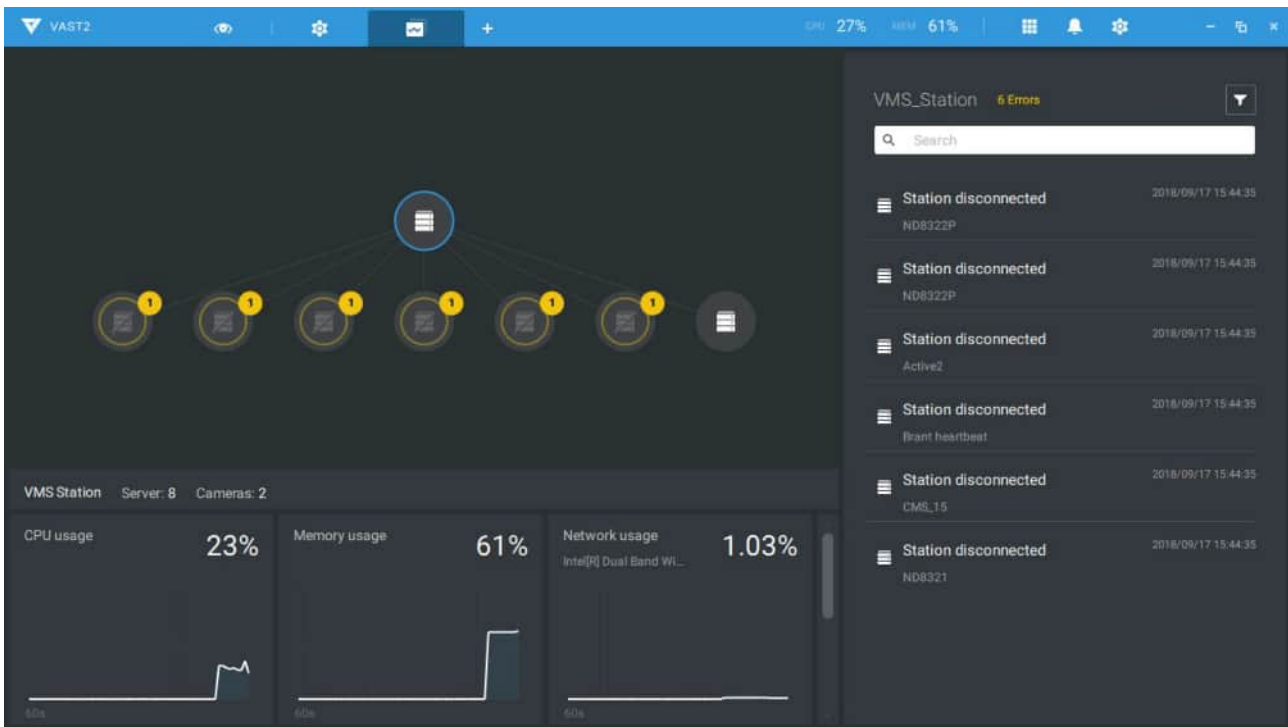

Note that VAST servers of the earlier revisions and NVRs running older firmware do not deliver their statuses to your Dashboard.

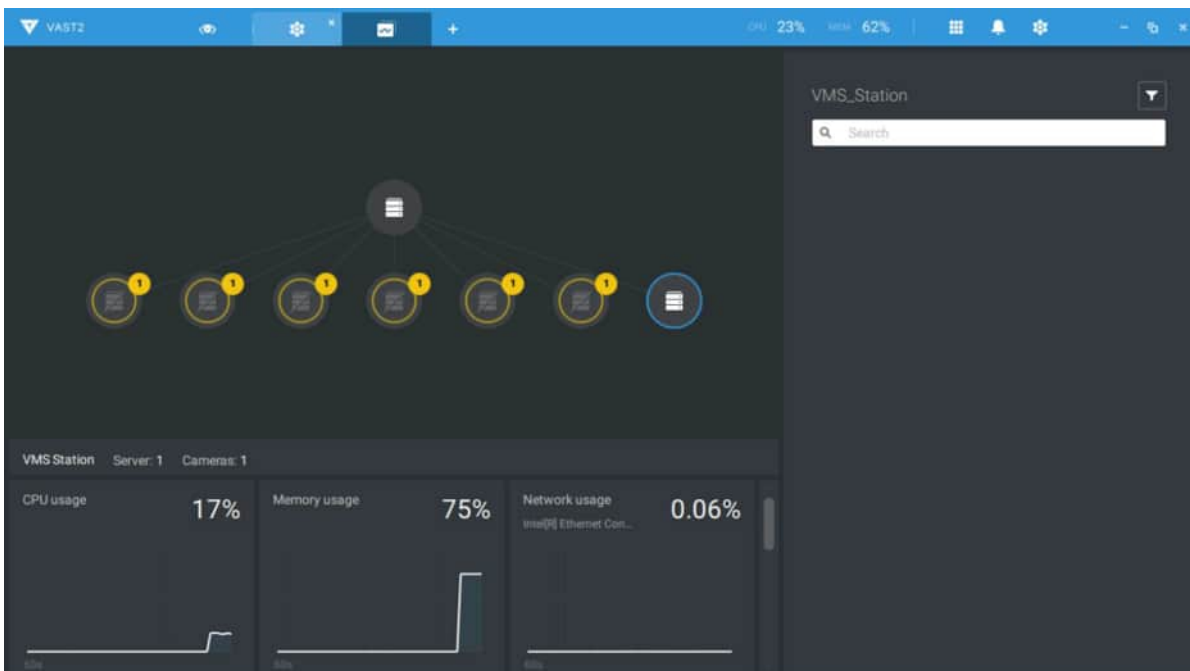

2-2-10. E-Map

To create your E-Map, click **Settings** . Click **Import & Setup**. Click E-Map.



Click Import file  or Import folder . An entire folder can be imported.

When done, double-click on the snapshot of E-Map image to configure the E-Map.

Your cameras will be listed on the left. Drag and drop the cameras to the corresponding locations on the map.

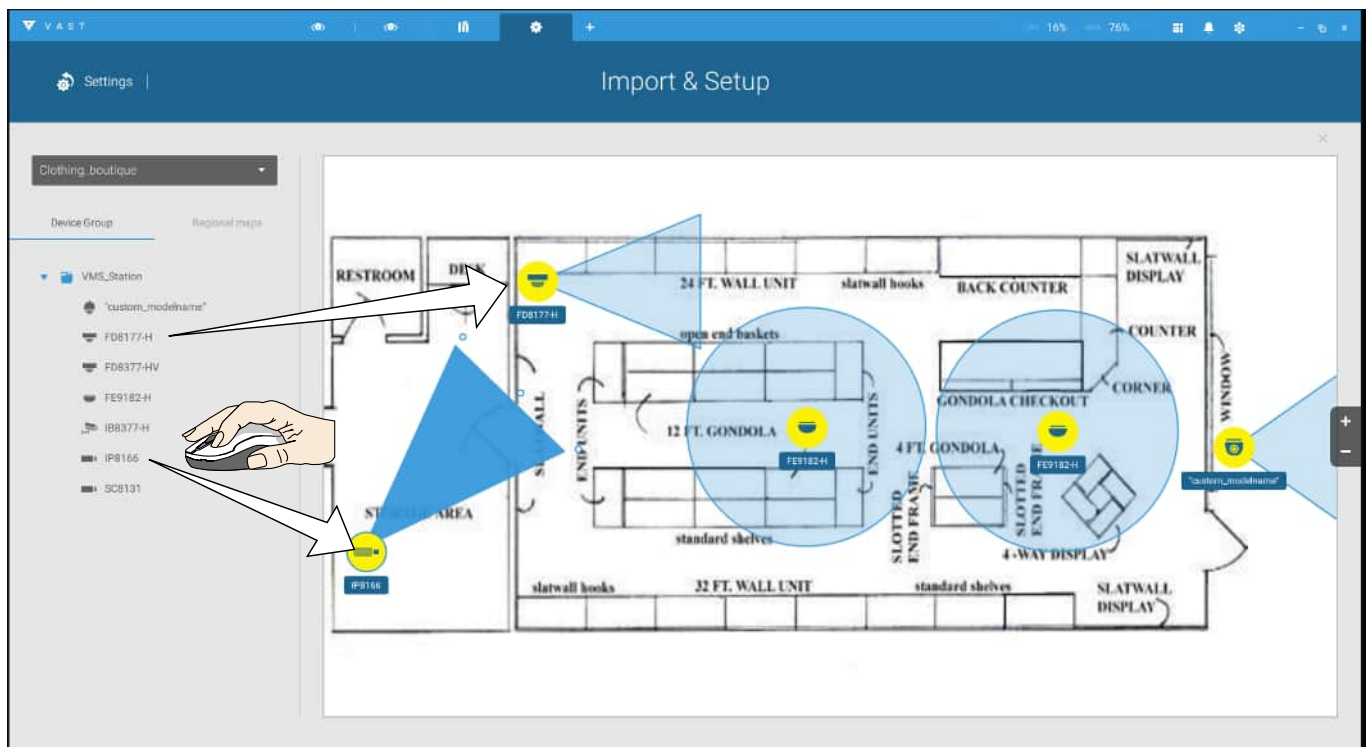

When the camera is in place, drag the FOV indicators on the edge to change the shooting angle and the coverage range.

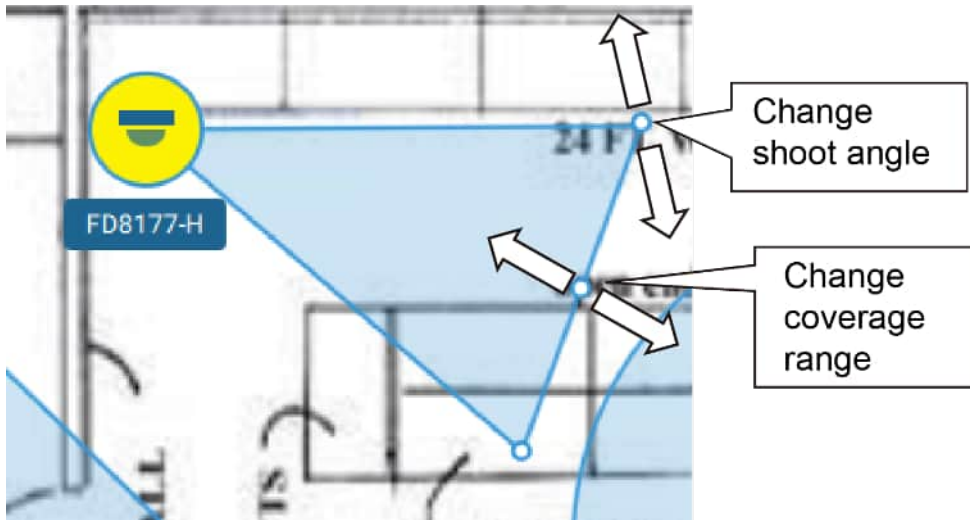

Drag the FOV to change the shooting direction to match the actual installation.

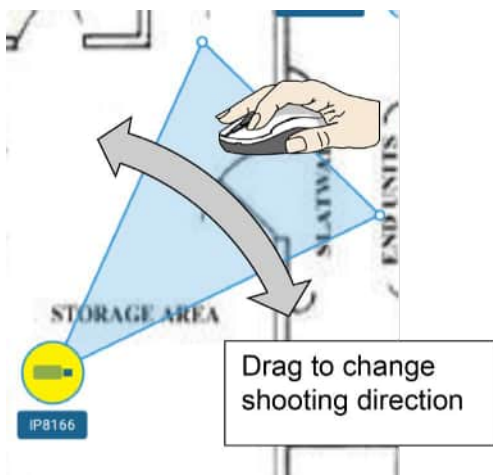

Click on the camera icon. You can also change the color of camera icon and the FOV type. Fisheye cameras, when ceiling mounted, have a round shape coverage.

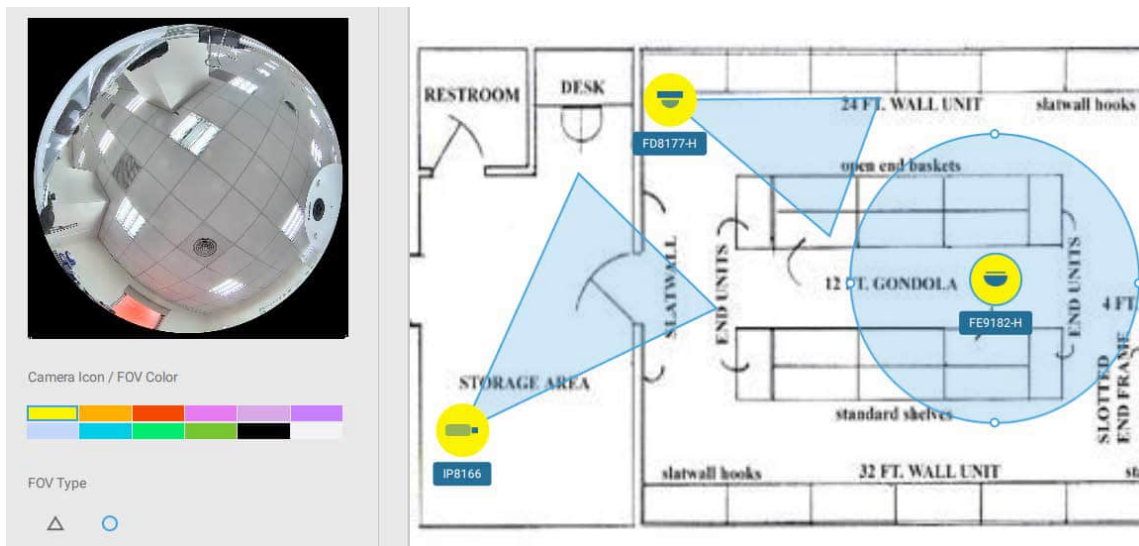

If you have a larger regional map that covers a geographical area, say, a street block, you can drag one or many E-Maps into it. For example, you can place another E-Map that is used to indicate the camera deployment inside a building that is located on the street.

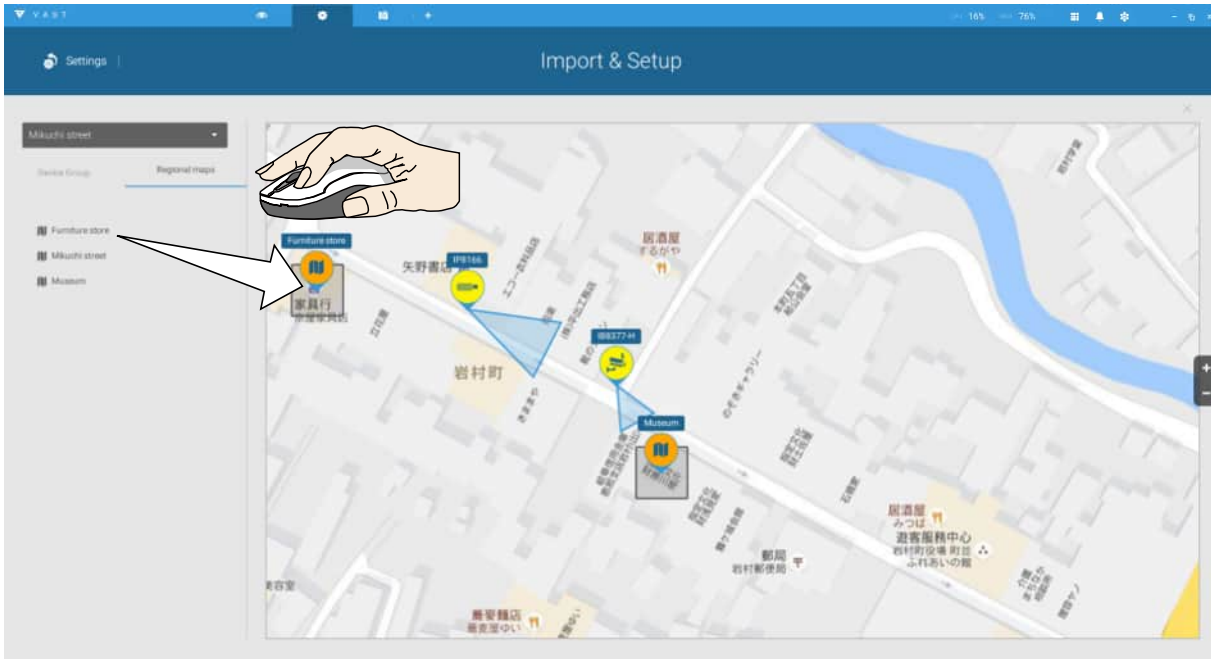

To see live streams from cameras, click on the camera icons in the E-Map.

When configuring an E-Map, you can use the tilt bar on the right to tilt the E-Map image. Doing so creates a sense of distance and depth of view.

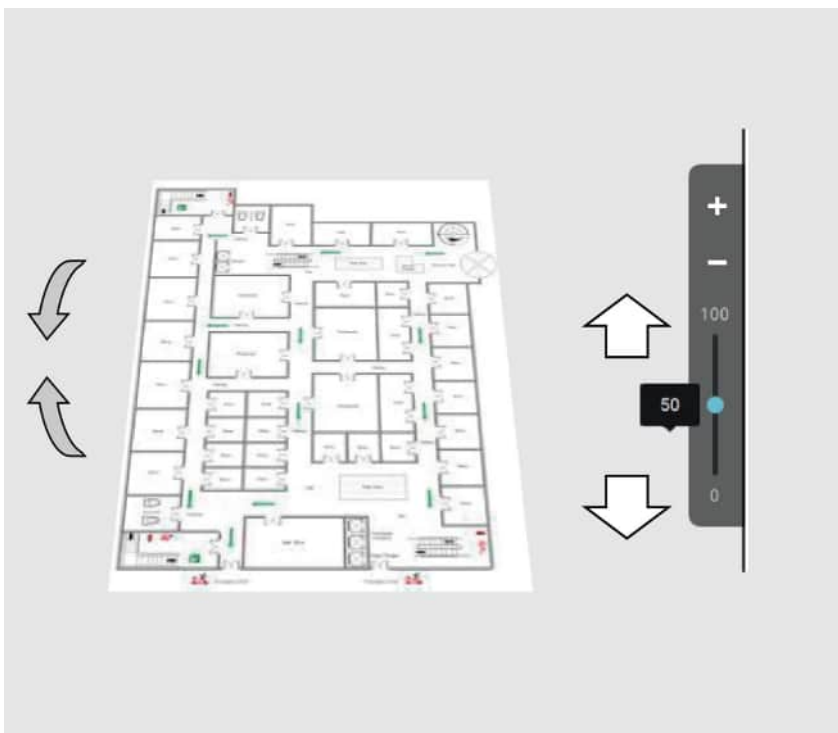

Placing DI/DO Devices

I/O devices can also be planted into an Emap, such as alarm or various kinds of detectors. The I/O boxes (such as Advantech's Adam series) or the DI/DO connections on an NVR also apply.

1. Select a floor map from the pull-down menu.
2. Unfold the sub-trees beneath the network camera, (taking camera DI/DO devices as an example).
3. Select a DI/DO device. Click and drag to a preferred location on map.

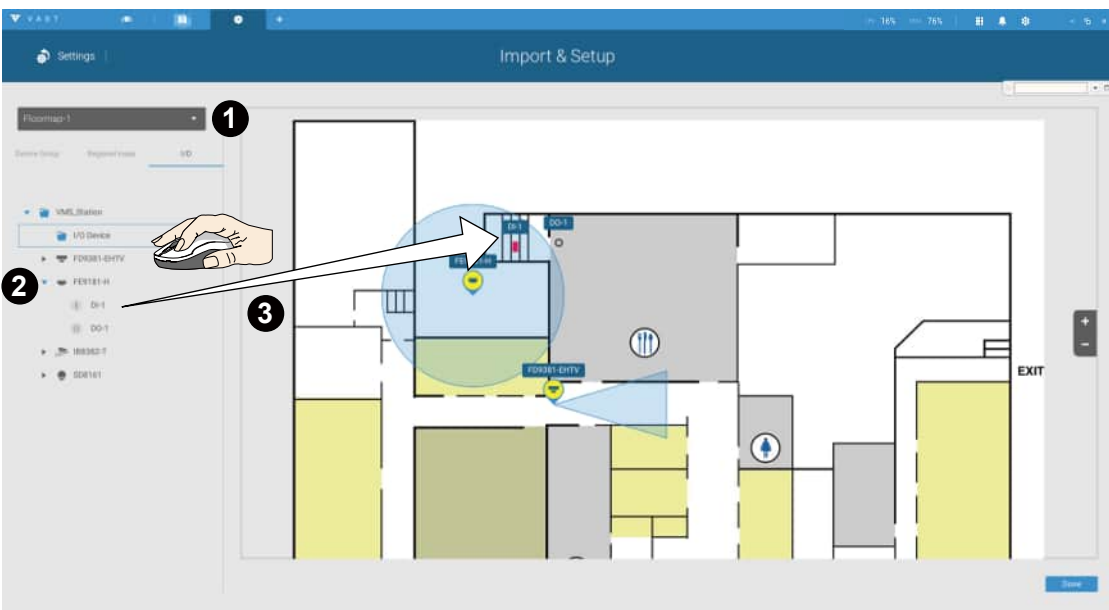

4. When a DI/DO device is selected, you can select the display colors of its icons. Configure different colors for the device status when it is normal or triggered.
5. When done with placing all DI/DO devices, click the Done button on the lower right of the configuration screen.

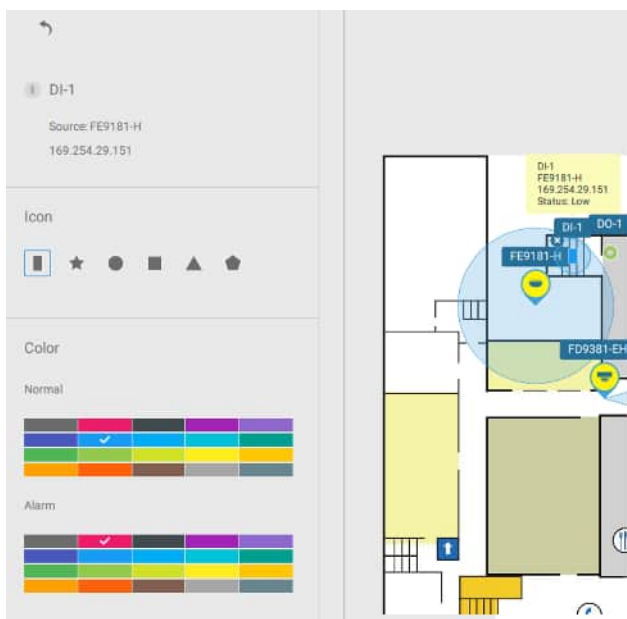

Configuring Google Map and GPS

Since Google Map changed its access policy, using the Google Maps feature requires user entering a billing API key. Using Maps, Routes, and Places APIs requires an API key.

For applying a Google API key, <https://cloud.google.com/maps-platform/maps/>

Visit **Settings > Emap > All Maps**.

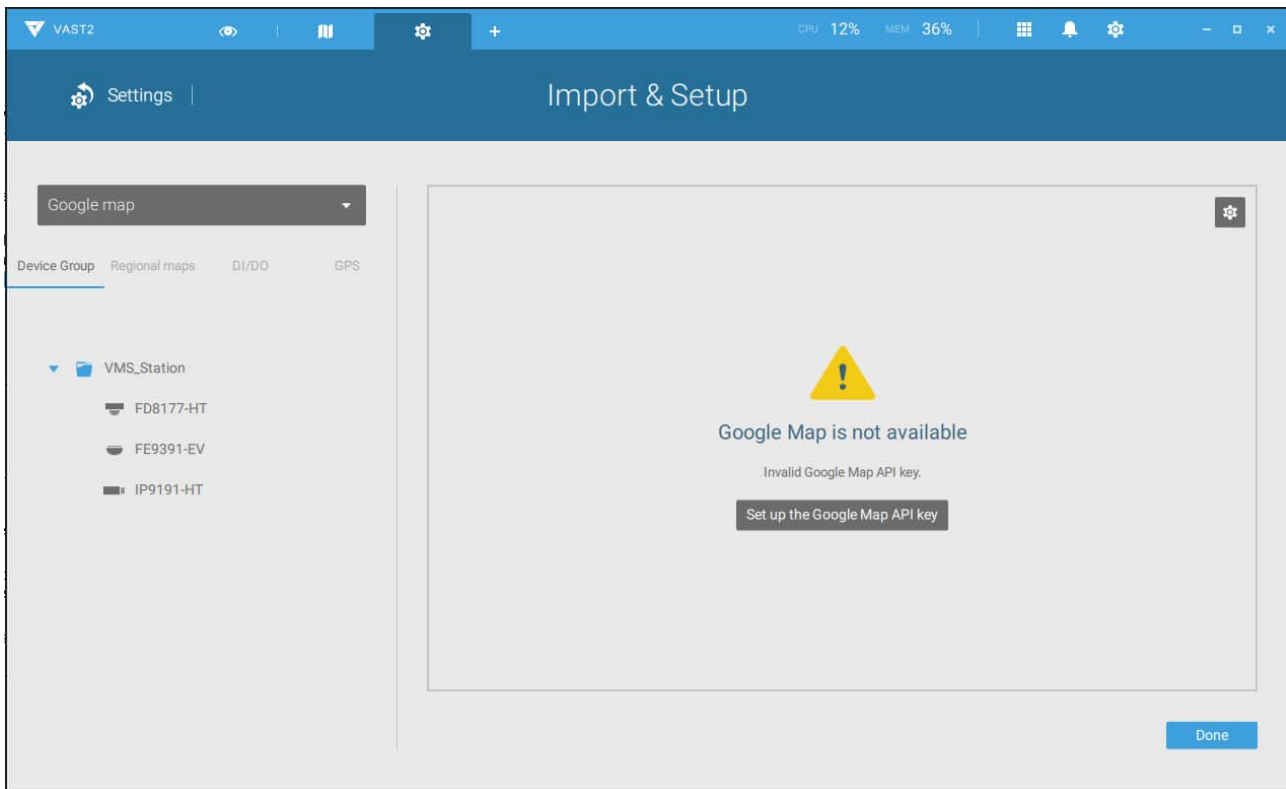

Enter the Google API key you previously registered (if using Google Map).

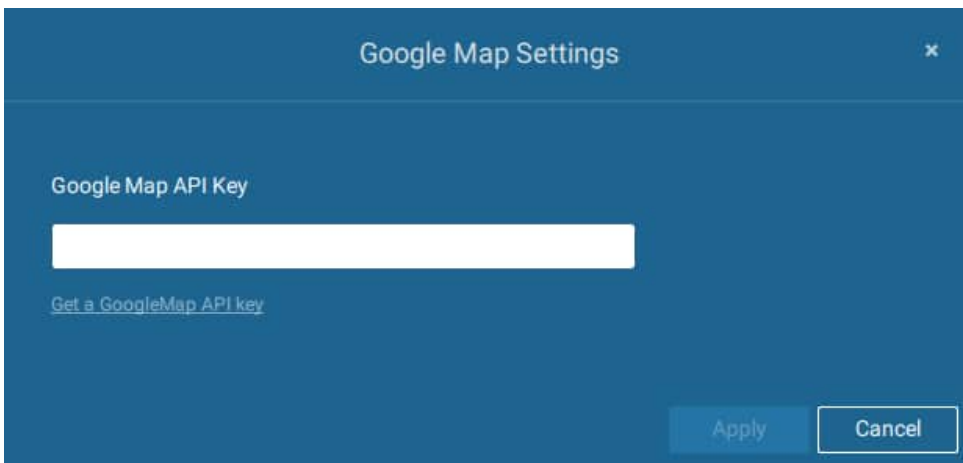

NOTE: In this revision, Google Map only supports installation on a GPS-enabled vehicles. Placing cameras on a static location on Google Map is currently not supported.

Before configuration on a Google Map, you should prepare an E-map drawing for special installations, such as that on a vehicle. The vehicle, e.g., a train, should come with a GPS-GSM/GPRS module to collect the position information and passes this information to a web-server. As new data is constantly inserted to the database, the VAST server will update the location information containing coordinates, speed, distance, time, etc.; and when video recording is required, the location information and time tags will be available.

This applies to a mobile NVR that comes with GPS.

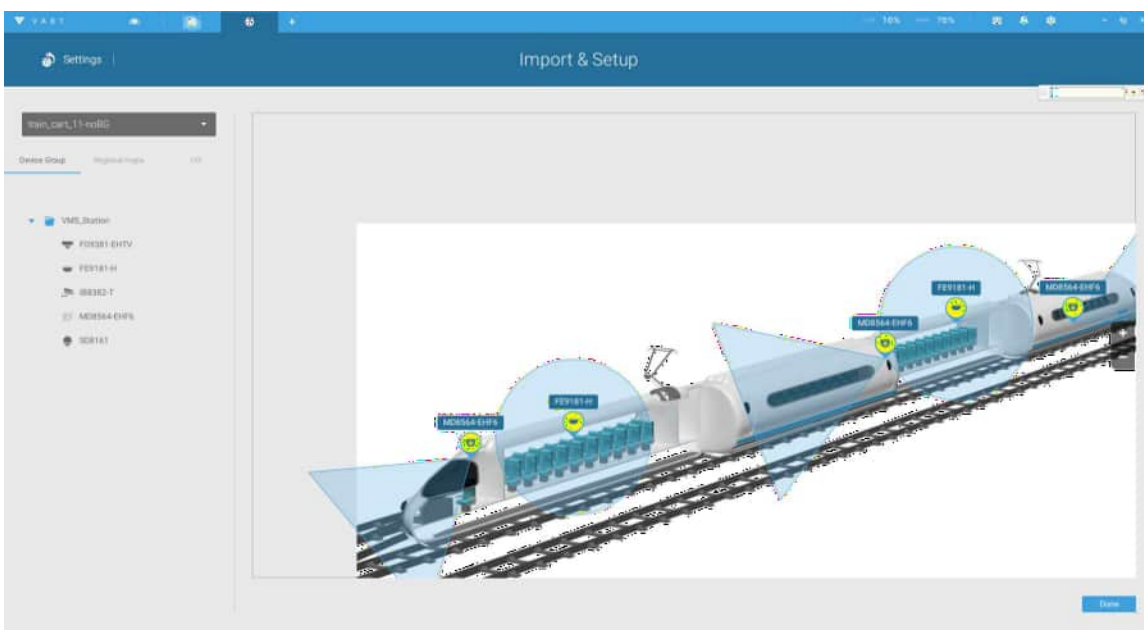

Open the E-Map Import & Setup window.

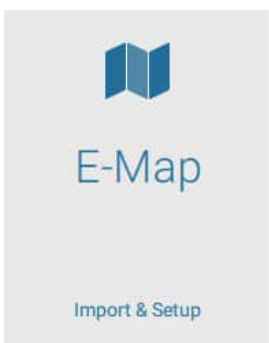

Click to enter the GIS (Geographic Information System) Map and then Google Map window.

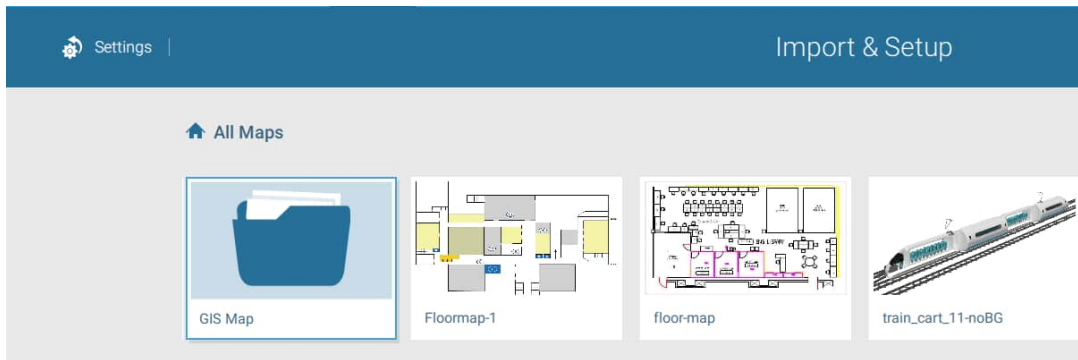

Click on either the Google map or the OpenStreetMap.

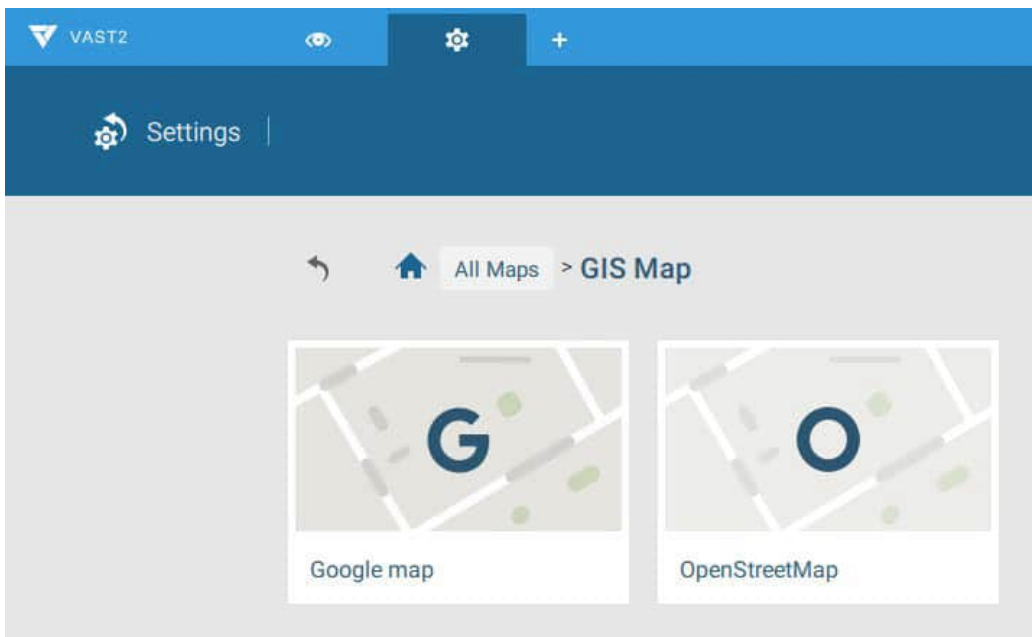

Click on the GPS tab. Select a VMS station or mobile NVR to apply the configuration, and then select the GPS Add button .

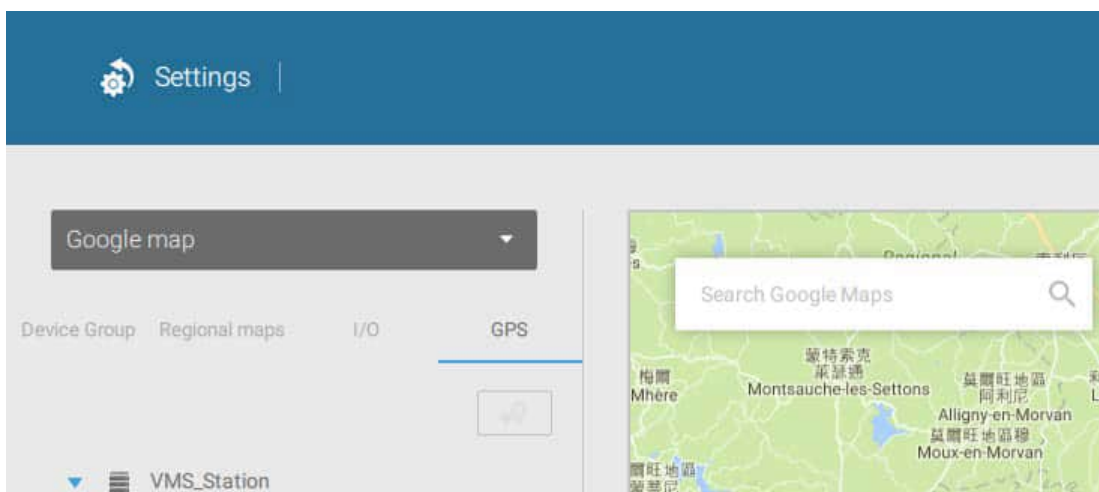

Enter a name for the GPS/GNSS server on the vehicle, its IP address, and server port number. You can select an E-map that will display when you click on the GPS location icon. Select the checkbox and an E-Map that corresponds to the deployment on the vehicle. When done, click the Apply button.

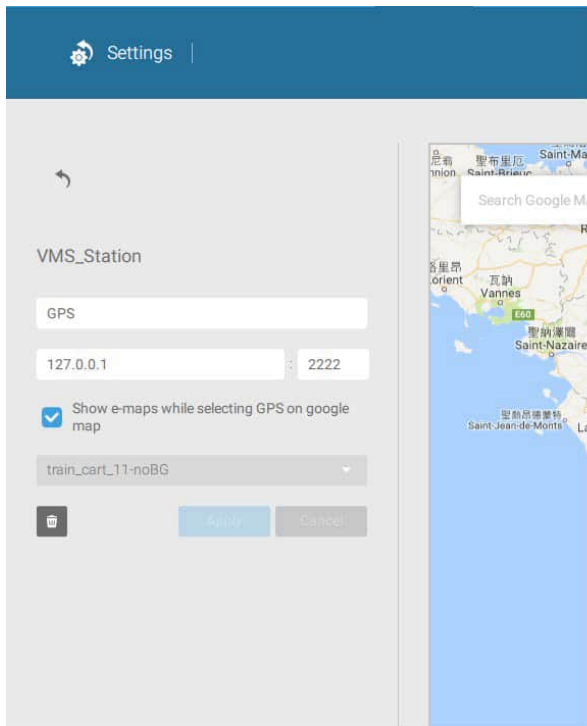

You can skip this setting for the mobile NVR that comes with a built-in GPS module.

You can click on the location icon  to bring up the E-Map. The coordinates, speed, and time information also display on the map.

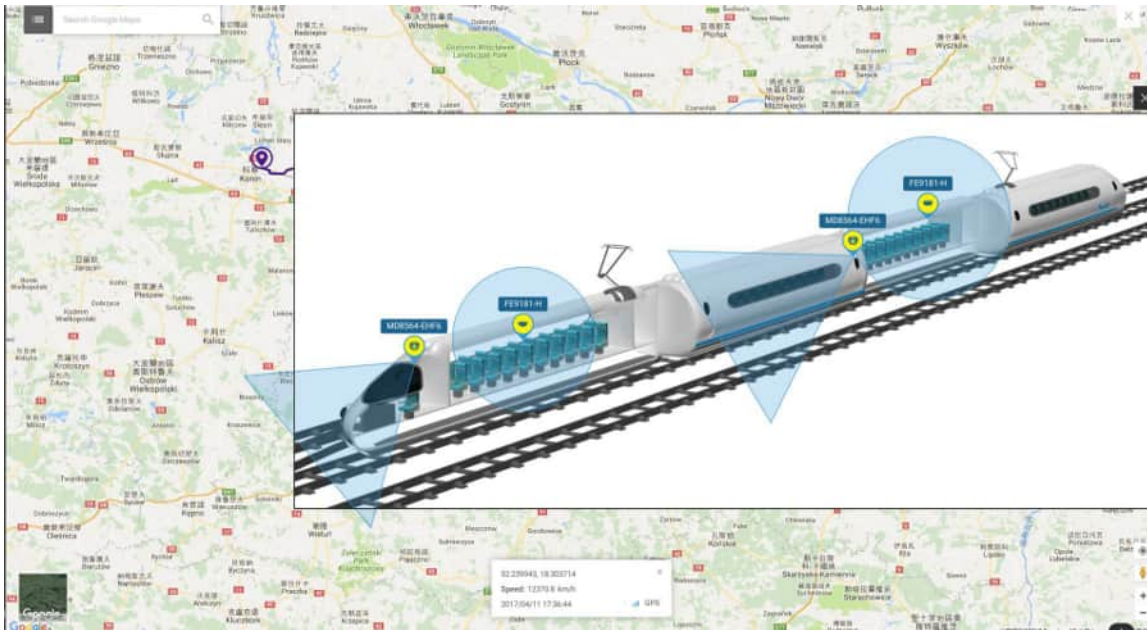

You can click on any cameras on the E-map to search through past recordings. One click displays the live view. A live stream window will display.

To search and review recordings when an event occurs,

1. Click on the Playback button.
2. Click the Pane button to display the Playback control panel.
3. To search for the video of past events, pull the Playhead to a point in time on the timeline.
4. The GPS coordinates and time will change to those corresponding to the time you selected. You can then acquire the corresponding location information while tracing the occurrence of an event.

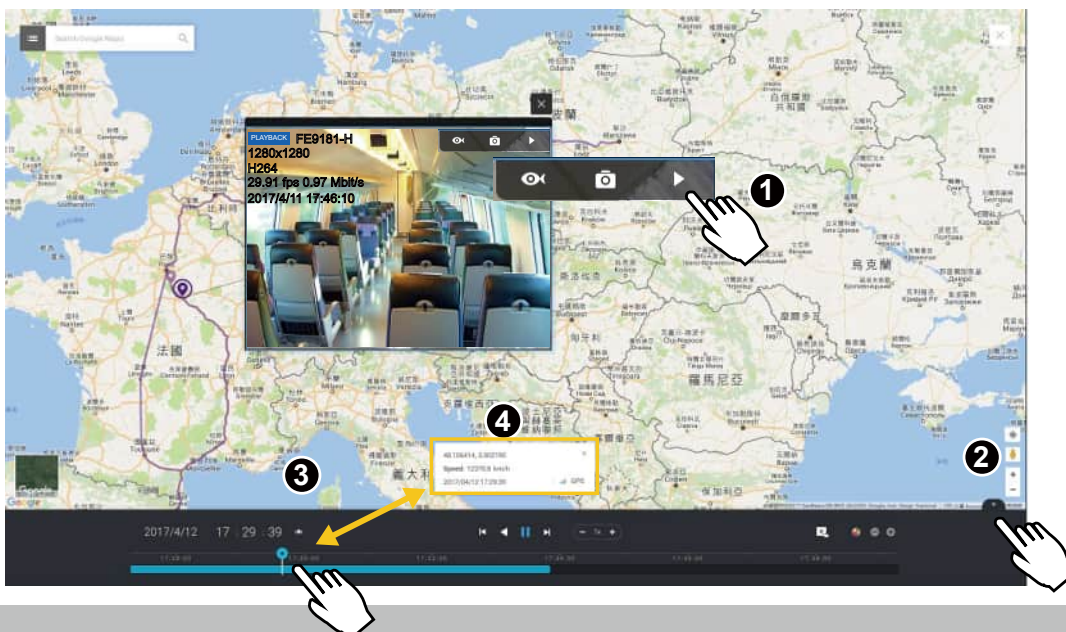

Click on the Setting button  on the map to bring up the Map update frequency option. Your GPS target may travel to the outside of the map through time without the map being updated. The map will update by the interval you configure here.

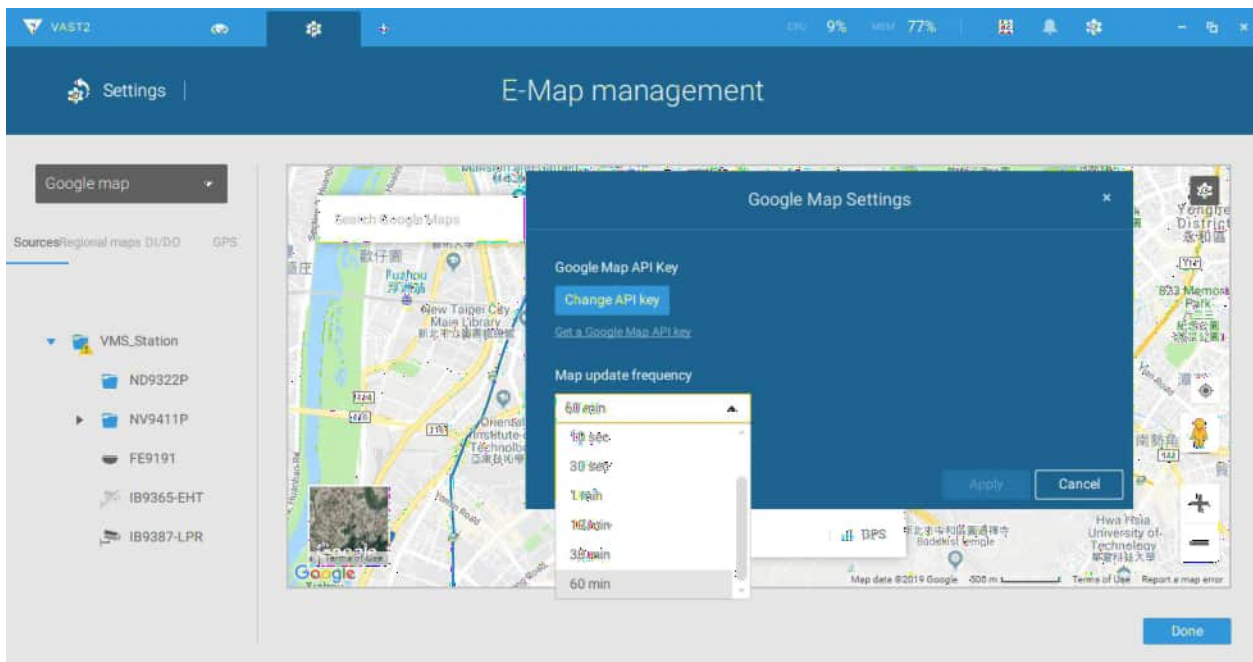

2-2-11. Event Search

The Event Search window is accessed from the top tool bar.

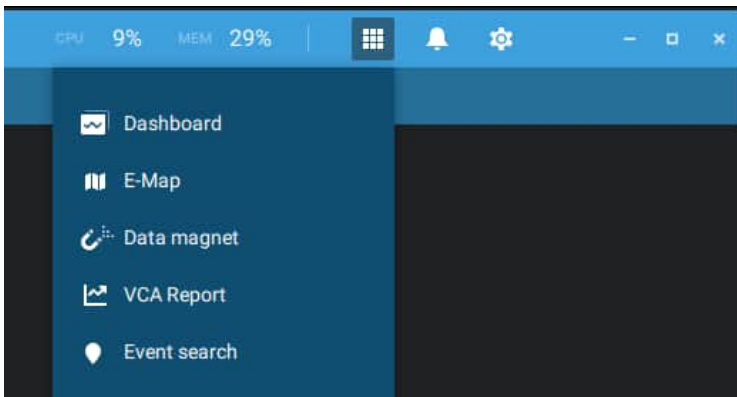

Below is the comparison between the Alarm list and the Event search windows:

Alarm List	Event Search
<p>Reports alarms triggered by user-configurable events, such as DI/DOs, Motion Detection, tampering, VCA analytics, cybersecurity, and so on.</p>	<p>The events on the Event Search window require no user configurations. The Event Search window displays system events and provides a glimpse of all general events.</p> <p>The event types include: General events, Smart VCA events, and Trend Micro IoT Security events.</p>

The sample screen for VCA-related events is shown below:

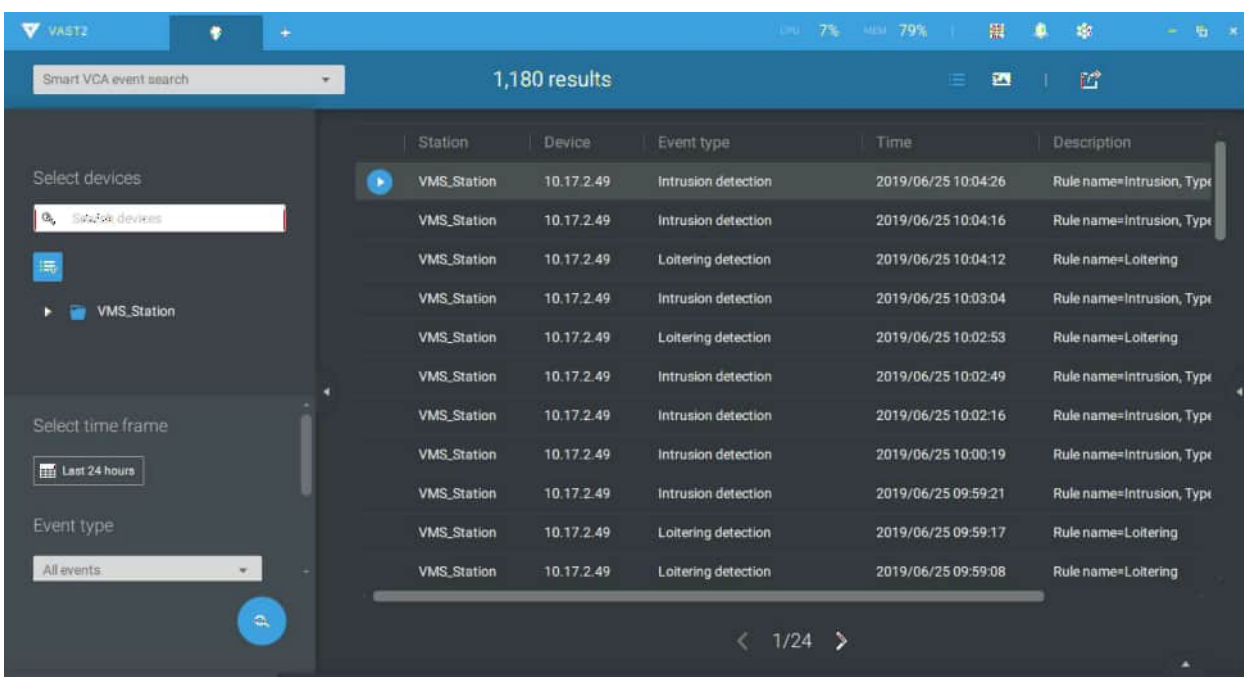

The sample screen for network security-related events is shown below:

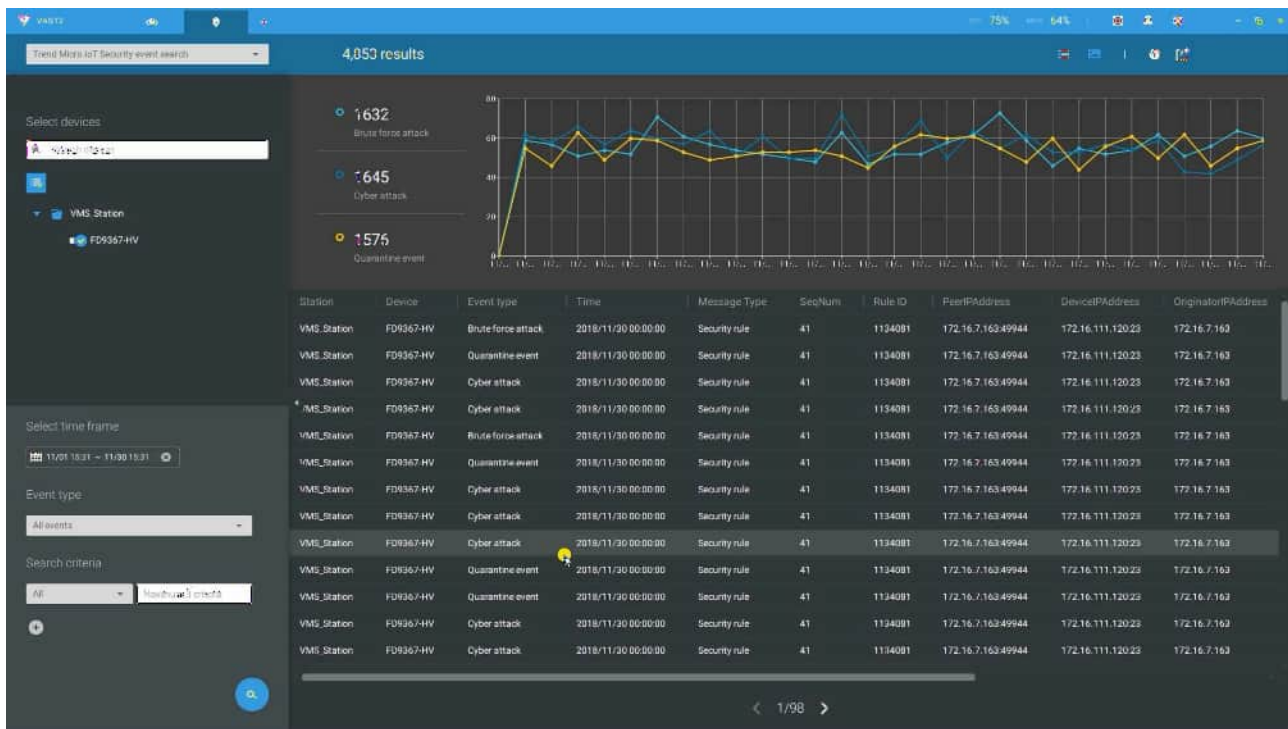

From the Search Event window, you can view and search events by its event types, and use the Export  button to save a record of these events (in the CSV format).

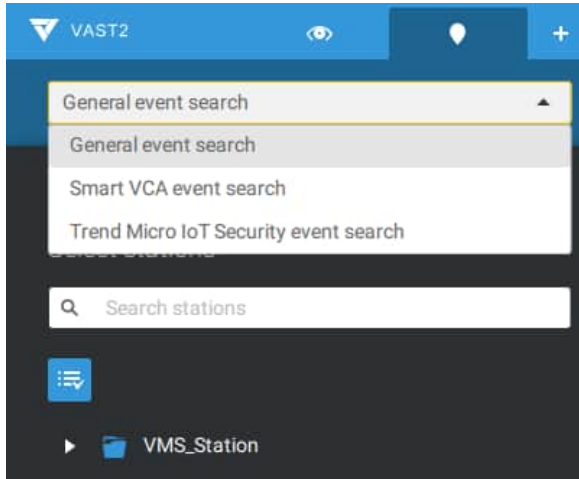

Use the calendar tool to specify the span of time as the search range.

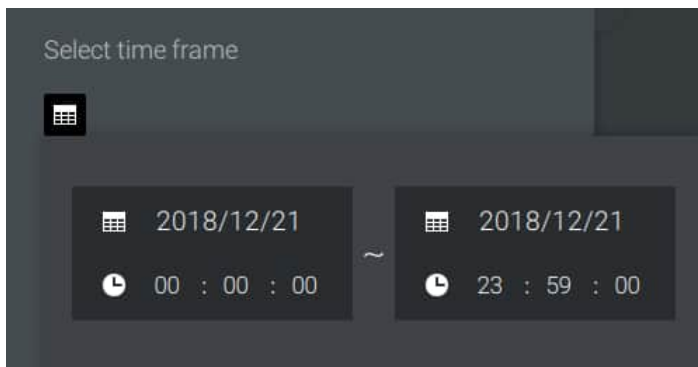

Use the Event type menu to narrow down the types of events. Select or deselect the event types for search. You may also enter one or several keywords as the search criteria in the following menus.

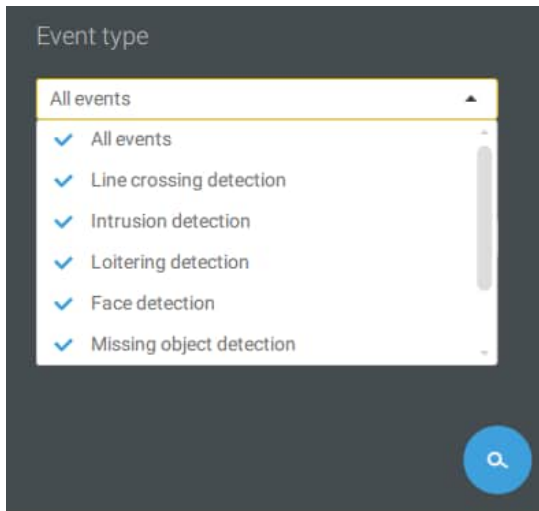

Click the search button to generate search results.

2-2-12. PTZ Control

PTZ on this page refers to the mechanical PTZ. The discussion on this page applies to cameras that come with PTZ mechanisms that are capable of directional and zoom control.

To begin the PTZ control, click on the PTZ  button.

Click and drag your left mouse button across the screen, towards the direction you wish to move. A light blue trace will appear. The longer the trace, the faster the move.

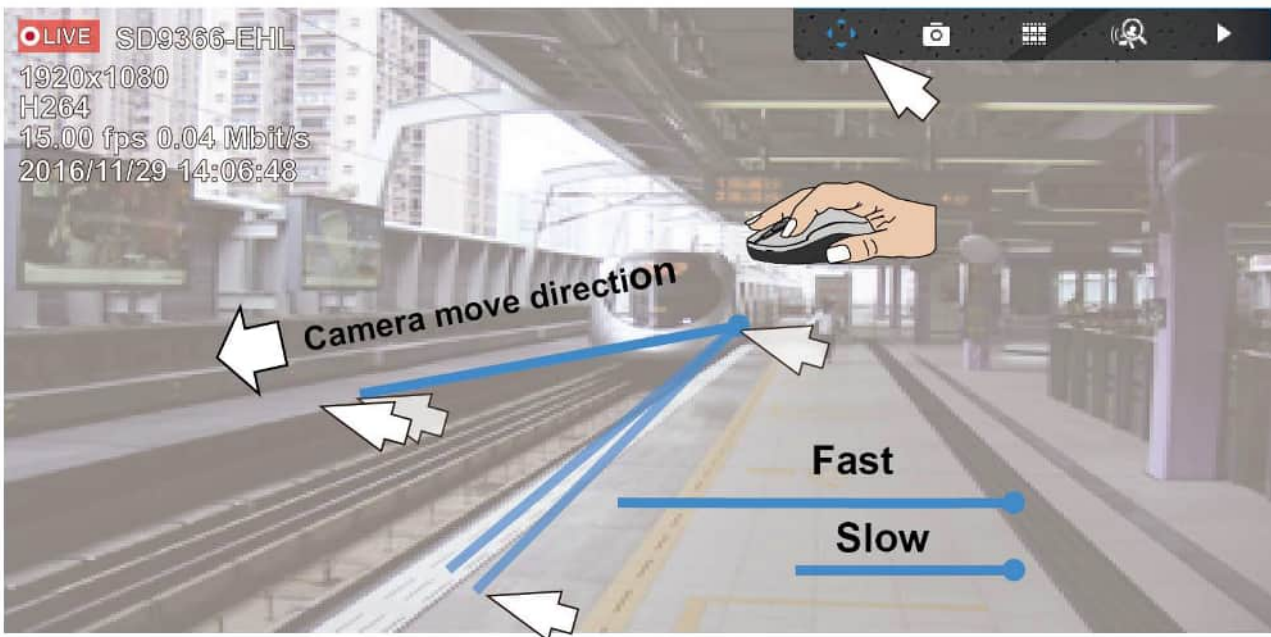

Note that while the camera is moving, you can change the move direction keeping the mouse button hold down. Release the button to stop moving.

See Appendix C Joystick support if you use VIVOTEK's joystick.

You can also use the mouse wheel to zoom in or zoom out. You can also mouse over the right side of the screen to display the zoom button. A home button is also provided.

The **Patrol**, **Presets**, and PTZ control panel is located at the lower right of the screen. You can click to begin a pre-configured patrol, preset points, or enable a **Tracking** or **Pan** action.

You can also adjust the **Zoom speed**, and/or manually adjust the **Focus** and the **Focus speed**.

[See Appendix F Smart Tracking for how to enable the Smart Tracking feature.](#)

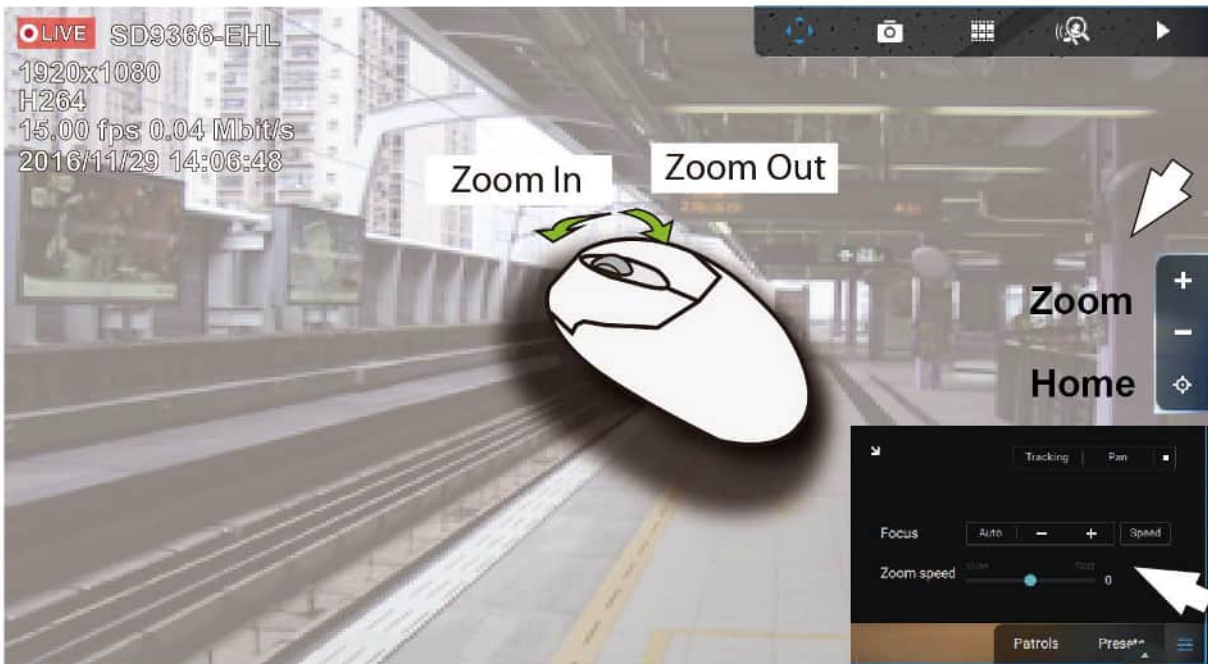

2-2-13. Playback

To start the playback function, select a camera's view cell (whether in full view or ordinary cell size), then click the playback initiative button (⏮ or ▶). The button can be found on the upper right of the view cell or at the lower right corner of the view cell in the full view.

Default Time: When started, system normally rolls back to the start of the hour, e.g., your current time is 10:30:00, and the default playback position on the timeline is 10:00:00.

Playback control can be found in 3 places:

1. **Float Panel:** When Playback is started, swipe your mouse to the upper-right of the view cell to display the Playback float panel.

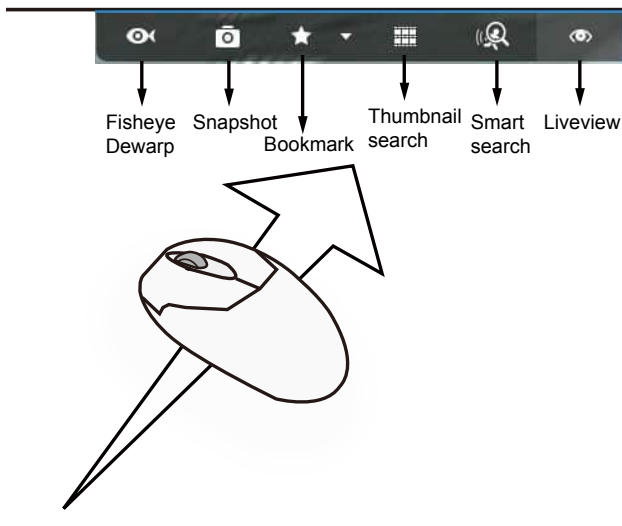

Fisheye Dewarp: For a fisheye camera, you can select different dewarped views during a playback. Click to select an option.

Snapshot: Click to take a snapshot. A small floating window will stay for 2 seconds. You can click the folder icon to access the snapshot files.

Note that a dewarped, regional view allows producing a snapshot of the regional view.

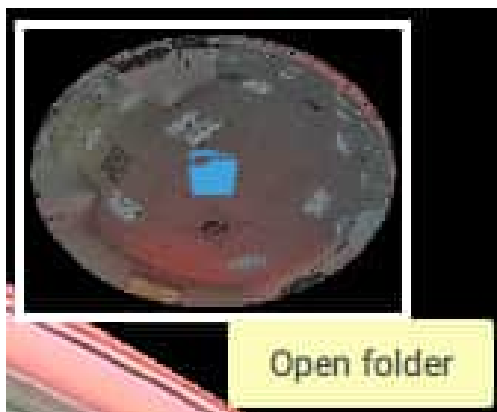

Bookmark: If you find anything of your interest when viewing the playback, click this button to create a bookmark. It helps when you need to return to the point in time after you review all through the recorded videos. Note that the bookmarked video clips are free from storage recycles. They will not be erased when storage space runs short and needs to be recycled.

Smart search II: Smart search II is an independent function. See page 168 for details.

Liveview: Click to return to Live view.

2. Right-click Menu: Right-click on the Playback screen to display this menu.

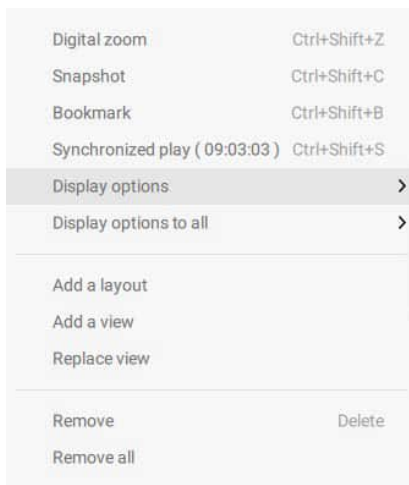

Digital zoom: If you find anything of your interest when viewing the playback, click this button to create a bookmark. It helps when you need to return to the point in time after you review all through the recorded videos.

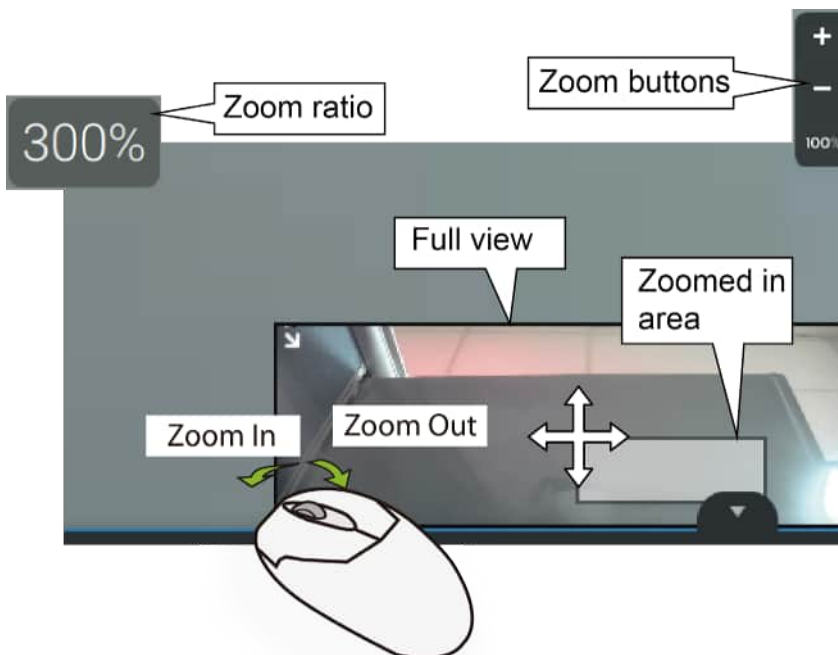

Snapshot: Click to take a snapshot. A small floating window will stay for 2 seconds. You can click the folder icon to access the snapshot files.

Bookmark: If you find anything of your interest when viewing the playback, click this button to create a bookmark. It helps when you need to return to the point in time after you review all through the recorded videos.

Synchronized play: When enabled, all cameras in the same view will be playing the video of the same point in time.

The following commands are general purpose commands.

Display information: By default, all display elements will appear on screen for all playback windows. You can use the Edit display information to select more display elements.

They include:

Status, Camera name, Server time, Codec, Resolution, Network throughput & FPS, Fit screen with ratio, POS transaction details (for POS), Data magnet data (Data overlay on screen / Hide data after idle), Motion detection, Rules (VCA), Rule name, Motion cells, Tracking block, Tracking dot, Exclusive area, People detection area.

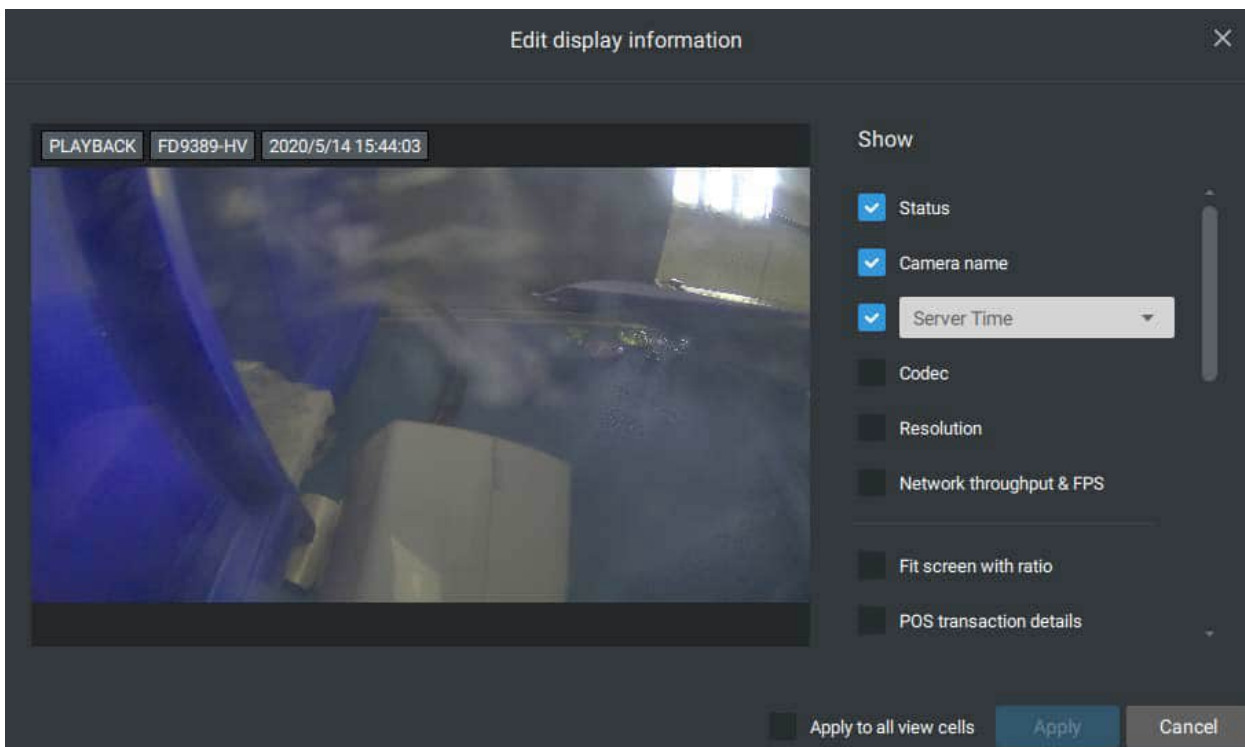

Data magnet: For 3rd-party applications, such as VIVOTEK's license plate recognition software, you can select to display different types of information. You can use the Edit display data to select or deselect the display elements.

Please note that the display elements can vary for different applications.

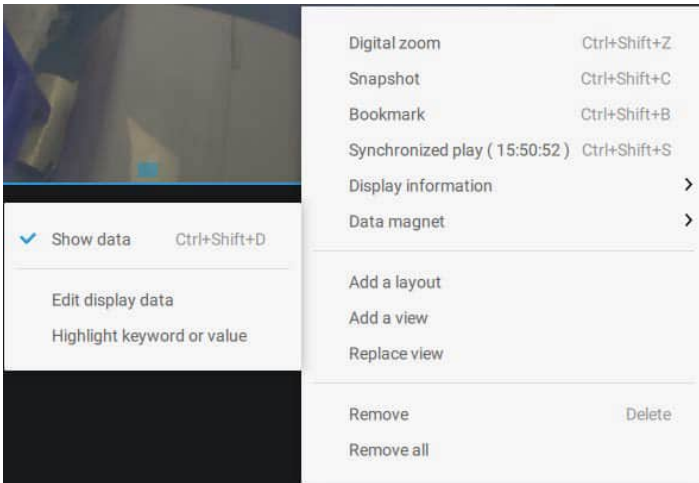

Below are the sample screens for applications implemented via the Data magnet.

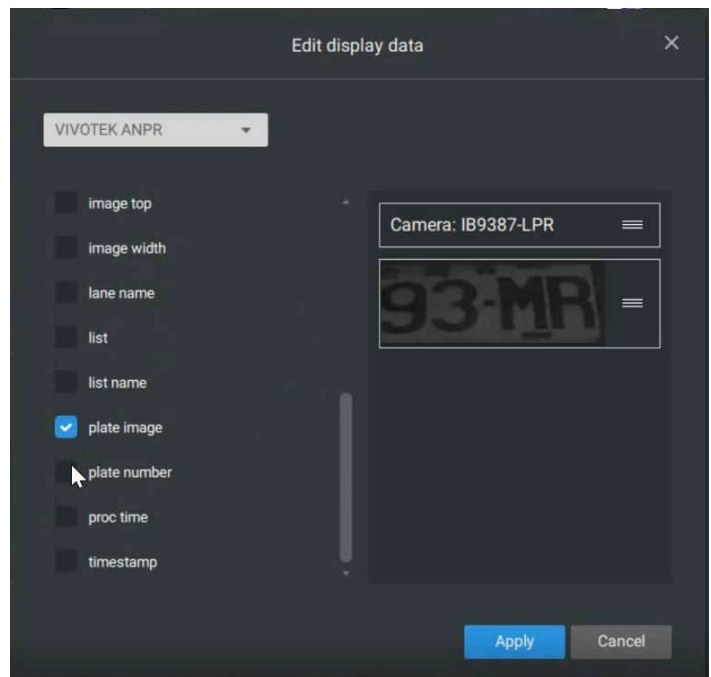
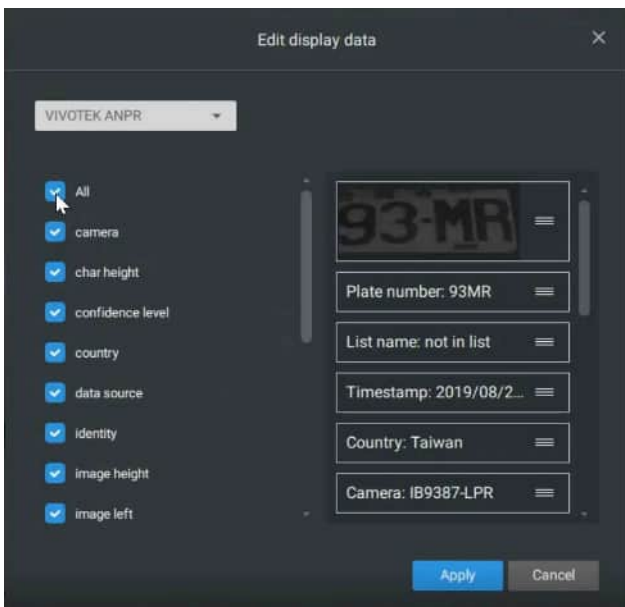

3. Timeline Panel: This panel appears when Playback is initiated.

Timescale is adjustable (minutes, hours, days, to a max. of 3 days) so you can easily find the required time period and begin playback from that point.

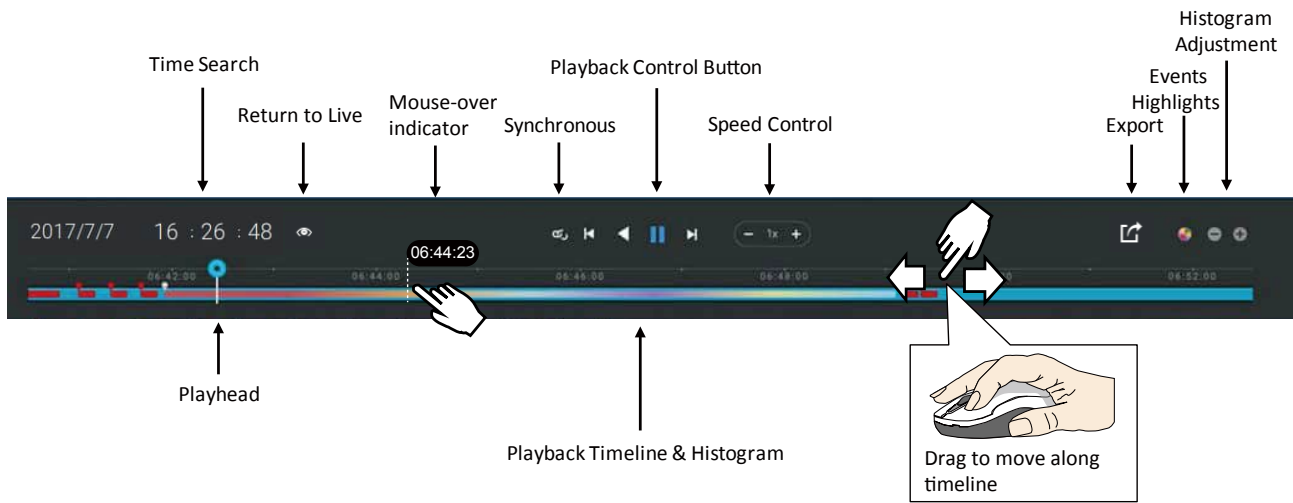

Starting from left to right, timeline control functions will be described as follows:

- 1. Time Search:** Click on the current date to open a calendar. If you want to review videos recorded in another day, select it from the calendar.

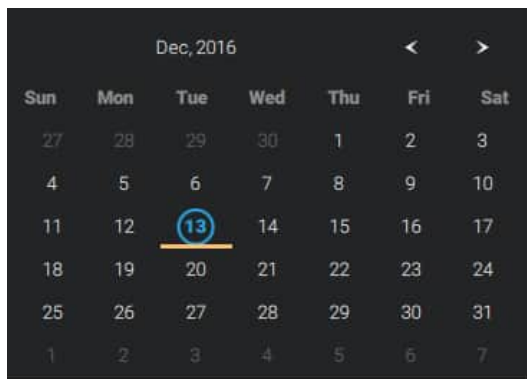

- Blue: days with recordings.
- Orange bottom line: Today.
- White: days with no recordings.

Click on the current time. You can use the arrow buttons to change the time you wish to playback, or simply enter a preferred number. You can also pull the playhead along the timeline.



Timeline magnification levels: The default time span is 6 hours. You can change the magnification level for easier browsing. Click the Zoom in and Zoom out buttons to change the timeline time span. The configurable time spans are shown below:

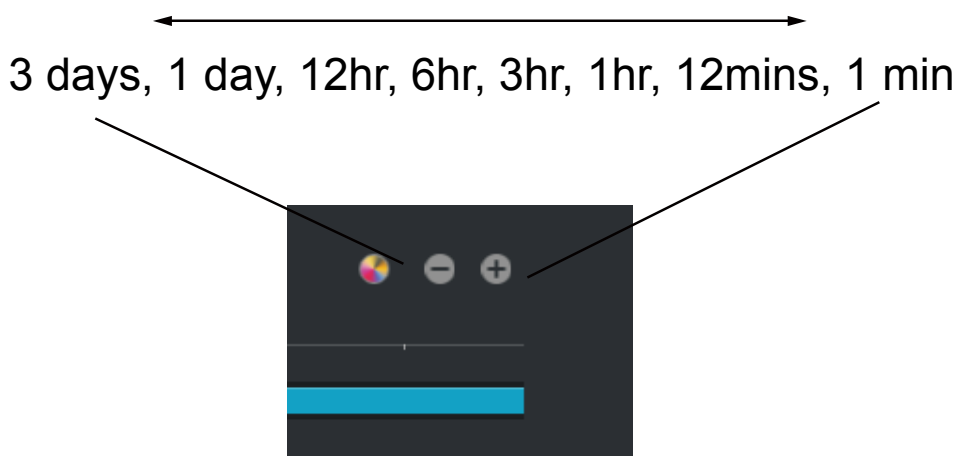

2. Playback control:

From left to right,

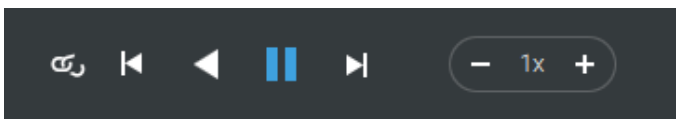

2-1. **Synchronous play:** This lets all cameras in the same view to playback video of the same point in time. If you perform synchronous playback on a multi-cell view, your computer can be stressed. It is recommended you create a new view with a 2x2 layout, select and insert camera views into it, and begin the Synchronous playback.

2-2. **Frame by frame buttons:** Click to move forward or backward to flick through the video frames. This may only display the I-frames.



2-3. **Forward playback and reverse playback:** Click to view the video in the forward or reverse playback manner.

2-4. Speed selector: The selectable speed ranges from 1/64x to 64x.

3. Export Clips: Click the Export Clips button . A range selector will appear. Pull the ends to include the time span you want to export. Note that each end of the selector, when clicked and selected, will turn white, and its location on the timescale is shown on the time line. When done, click the Start to export  button.



Depending on the length of video clips to export, it may take minutes to export. When the export is completed, a shortcut to the exported clips is shown. You may then open the folder where the clips are located.

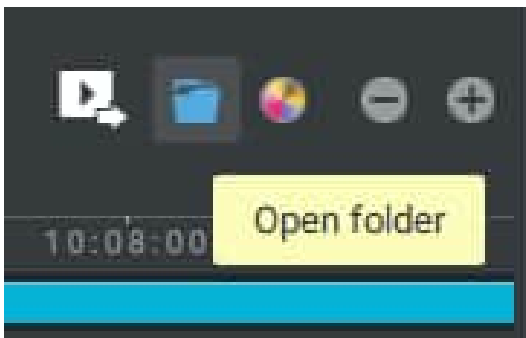

2-2-14. Alarm

The Alarms can be configured to perform a series of actions when different events occur. Alarms can be used to automatically react to possible threats. For example, the VAST server can start a recording or send an Email notification when Motion detection is triggered.

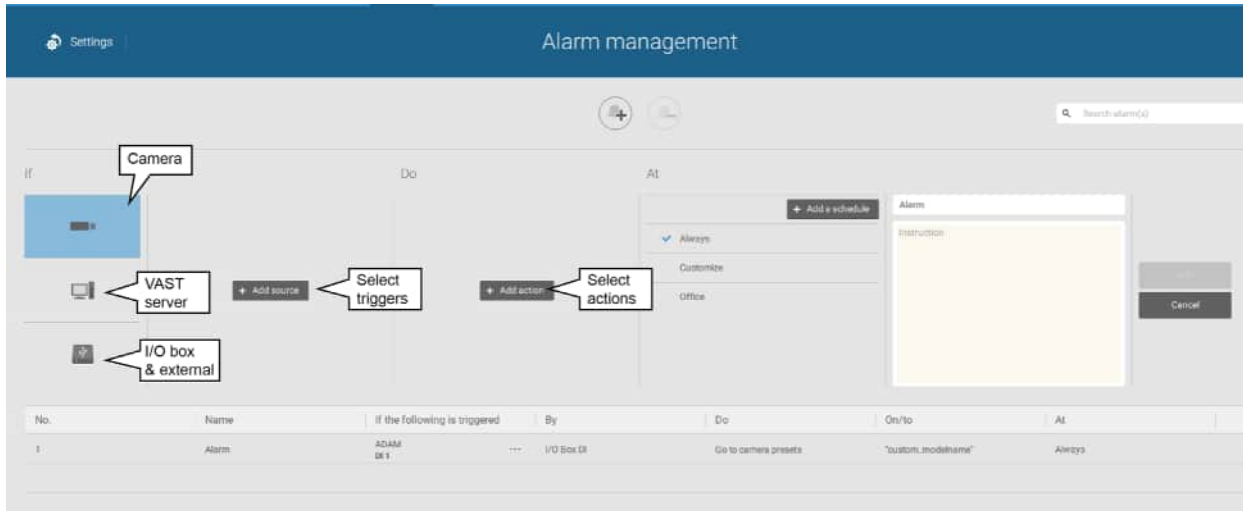

A wide variety of triggering conditions can be applied, including:

1. Camera triggers

General	
<input type="checkbox"/> Motion detection	<input type="checkbox"/> IR (Infrared)
<input type="checkbox"/> Camera DI	<input type="checkbox"/> PIR (Passive Infrared)
<input type="checkbox"/> Camera DO	<input type="checkbox"/> Tampering detection
<input type="checkbox"/> Temperature	<input type="checkbox"/> Stop recording
<input type="checkbox"/> Recording error	<input type="checkbox"/> Audio detection
<input type="checkbox"/> Video loss (Video server only)	<input type="checkbox"/> Shock detection
<input type="checkbox"/> SD card life expectancy detection	
Video Content Analysis	
<input type="checkbox"/> Line crossing (VCA)	<input type="checkbox"/> Intrusion detection
<input type="checkbox"/> Loitering detection	<input type="checkbox"/> Face detection
<input type="checkbox"/> Missing object detection	<input type="checkbox"/> Unattended object detection
<input type="checkbox"/> Crowd detection	<input type="checkbox"/> Smart tracking
<input type="checkbox"/> Zone detection	
Trend Micro IoT Security	
<input type="checkbox"/> Brute force attack	<input type="checkbox"/> Cyber attack
<input type="checkbox"/> Quarantine event	

Note that some of the triggers require that you open a web console to individual cameras. For example, VCA and Motion detection windows have to be manually configured on each camera before they can be configured in the Alarm settings.

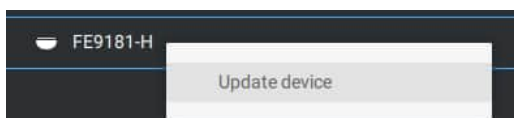

If you select a trigger and you cannot find a corresponding device, you need to open a web console to that device. Make sure the corresponding VADP is running. Open the VAST2 device tree, right-click on the device to perform a manual refresh "Update device" to acquire the latest configuration update.

If a triggering condition is associated with event recording, an event prompt will pop up on the screen when a triggering condition is met. For example, the number of people exceeds a preset threshold in a Crowd Detection configuration. The sample prompt is shown below. The related footage can be played back by clicking on the event entry.

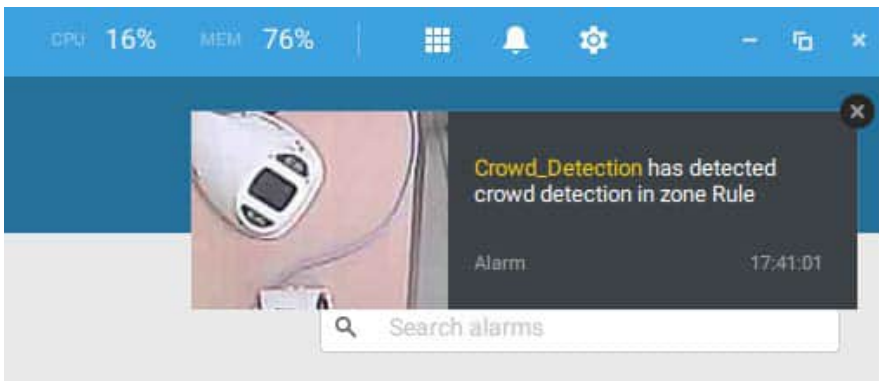

On the Alarm tab, you can select to mute all alarms for a configurable period of time. Enter the number of minutes or select to mute until you manually turn it back on.

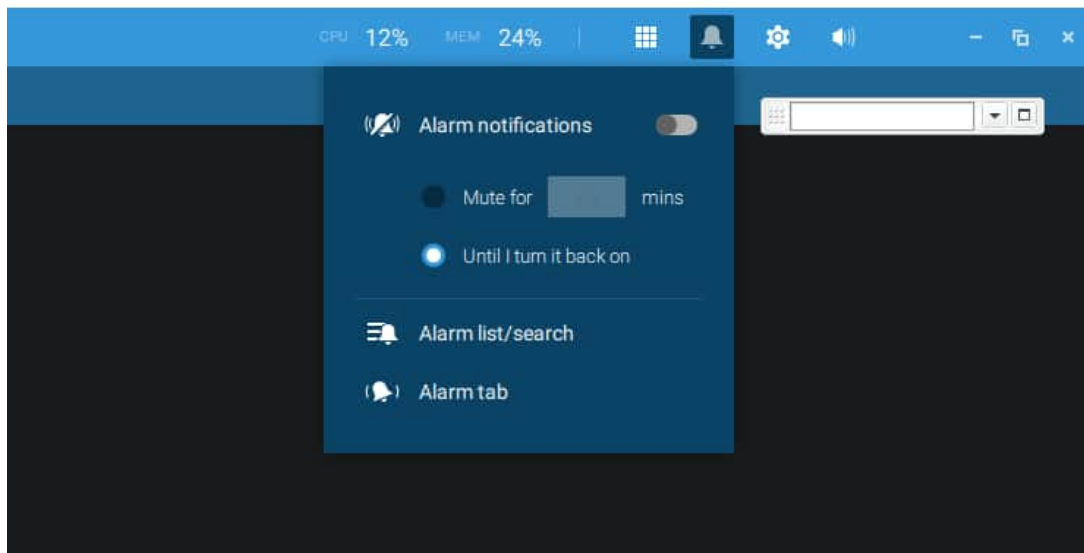

2. VAST server and NVR triggers



<ul style="list-style-type: none"> ● Network disconnected 	These can be used to send maintenance notifications.
<ul style="list-style-type: none"> ● Storage failure 	
<ul style="list-style-type: none"> ● Storage full 	
<ul style="list-style-type: none"> ● Fan status 	
<ul style="list-style-type: none"> ● GPS disconnected (Mobile NVR) 	The GPS and G-sensor related options apply to the Mobile NVR that comes with the GPS and G-sensor. GPS can be used to track the speed and location of a vehicle, while the G-sensor can be used to detect abnormal impact.
<ul style="list-style-type: none"> ● Abnormal G-sensor motion (Mobile NVR) 	
<ul style="list-style-type: none"> ● Speeding (Mobile NVR) 	
<ul style="list-style-type: none"> ● Number of remaining people 	<p>For VCA-capable cameras, the alarm can be triggered when the number of people staying within a specific area has exceeded the preset threshold. For example, when too many people are waiting in line in front of a cashier.</p> <p>This function requires appropriate configuration on the counting camera(s).</p>
<ul style="list-style-type: none"> ● Brute force attack (Trend Micro IoT) 	These can be configured as alarm triggers to notify the administrator that malicious attacks have occurred. Note that these triggers are available with NVRs that come with the protection of Trend Micro IoT packages.
<ul style="list-style-type: none"> ● Cyber attack (Trend Micro IoT) 	
<ul style="list-style-type: none"> ● Quarantine event (Trend Micro IoT) 	

* Note that you should use the pull-down menu to select a triggering condition, and then click to select a mobile NVR.

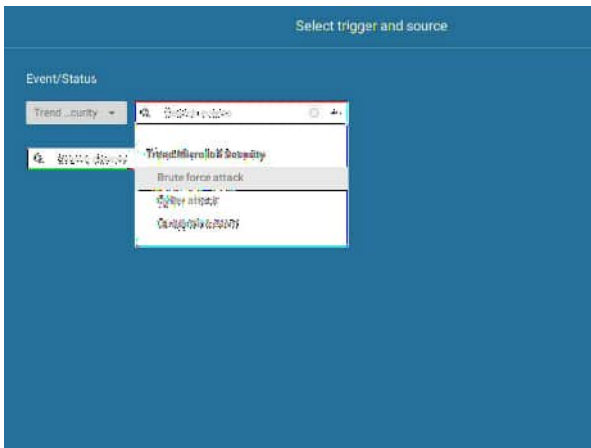
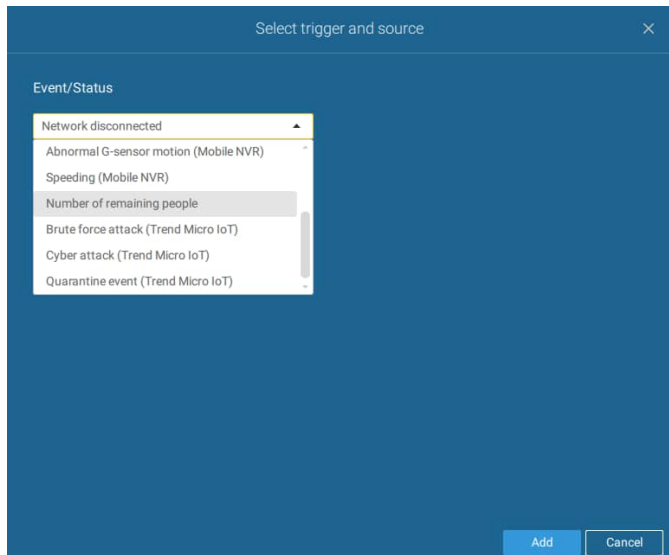
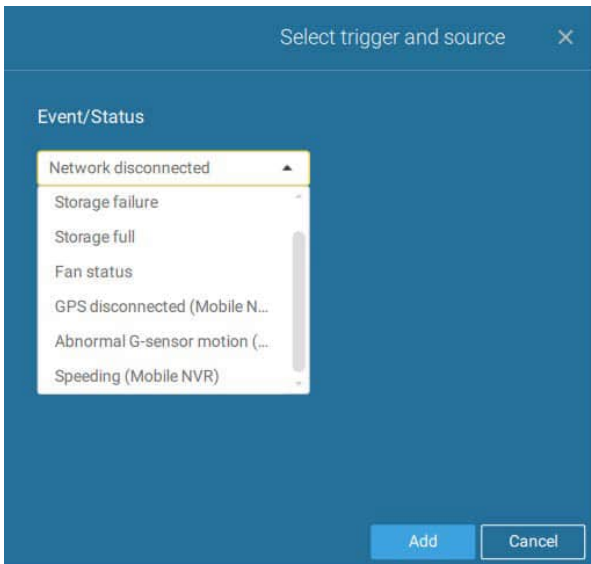

Note that the alarms will be received into the Alarm list window. The previous Alarm Search window is replaced by the Alarm list function.

The Alarm tab window is used to display the live video stream when an alarm is triggered, and its responding action is configured as "Send live streaming."

For I/O box configuration, please refer to the I/O Box page.

3. I/O box and TCP triggers



●	DI/DO Device DI	This applies when an external I/O box is applied, e.g., Advantech's ADAM I/O box.
●	DI/DO Device DO	
●	TCP Message	TCP message comes from the peer VAST servers or external sources (such as an access control system) via the analysis of received TCP message over the 3444 port. This is a paid feature.
●	Data Magnet	Triggering conditions can be acquiring data from 3rd-party software, such as the character height, image width, list, list name, country, from an LPR software, etc.

To configure a TCP message trigger,

Select TCP message as a trigger type, and enter a description, such as a short term, for VAST to listen and analyze data packages.

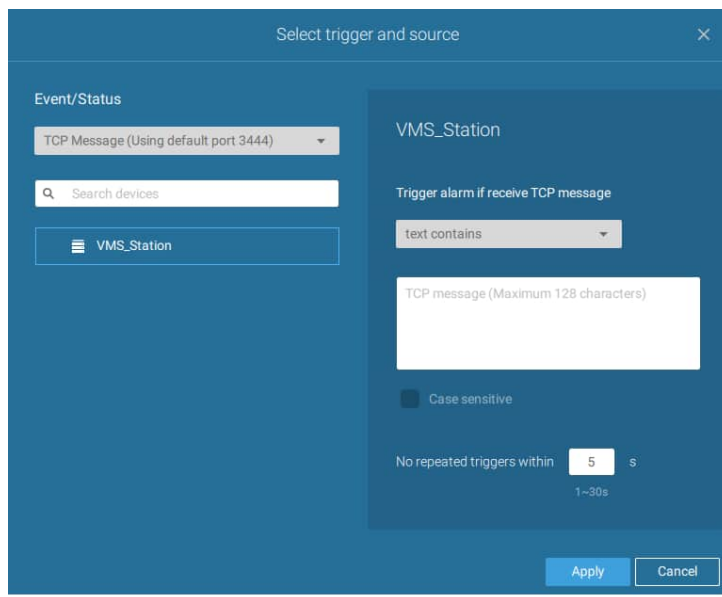

Below are the messaging parameters:

1. **text contains**: Messages will be received if some of the textual messages match the keywords.
2. **text matches**: Textual messages must be exactly identical.
3. **Case sensitive**: The upper or lower cases letters used in the messages must match within the messages.

You can use Telnet to send a small amount of data matching the term you entered in the TCP message configuration window. A TCP message event will be triggered, and you should see the event prompt as follows.

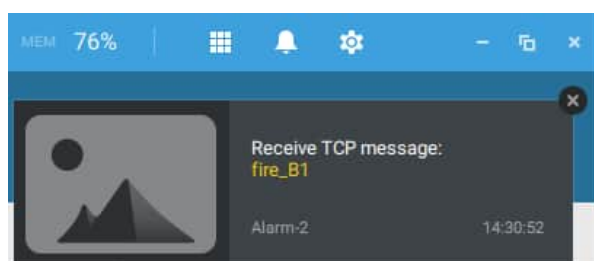

The available actions include:

<input type="checkbox"/>	Start to record video	<input type="checkbox"/>	Send HTTP requests
<input type="checkbox"/>	Set DO status	<input type="checkbox"/>	Send live streaming
<input type="checkbox"/>	Go to camera presets	<input type="checkbox"/>	Send email
<input type="checkbox"/>	Go to E-map	<input type="checkbox"/>	Sound the alarm
<input type="checkbox"/>	Add bookmark		

The [Start to record video](#) will record a video clip of the length of 10 seconds (default) on the occurrence of an event. The event recording pre / post event time is configurable. Except for Stop recording, all the other triggering conditions can be associated with this action.

The [Set DO status](#) will activate a DO connection. For example, to light an illuminator or sound an alarm.

You can select a camera, and its DO pins will appear on the right. You can configure the duration of the DO trigger, e.g., 15 seconds.

If no Trigger period is configured and when there are multiple instances of DO trigger, administration troubles may occur. Use the arrow marks to configure a trigger period. You may also manually enter a number.

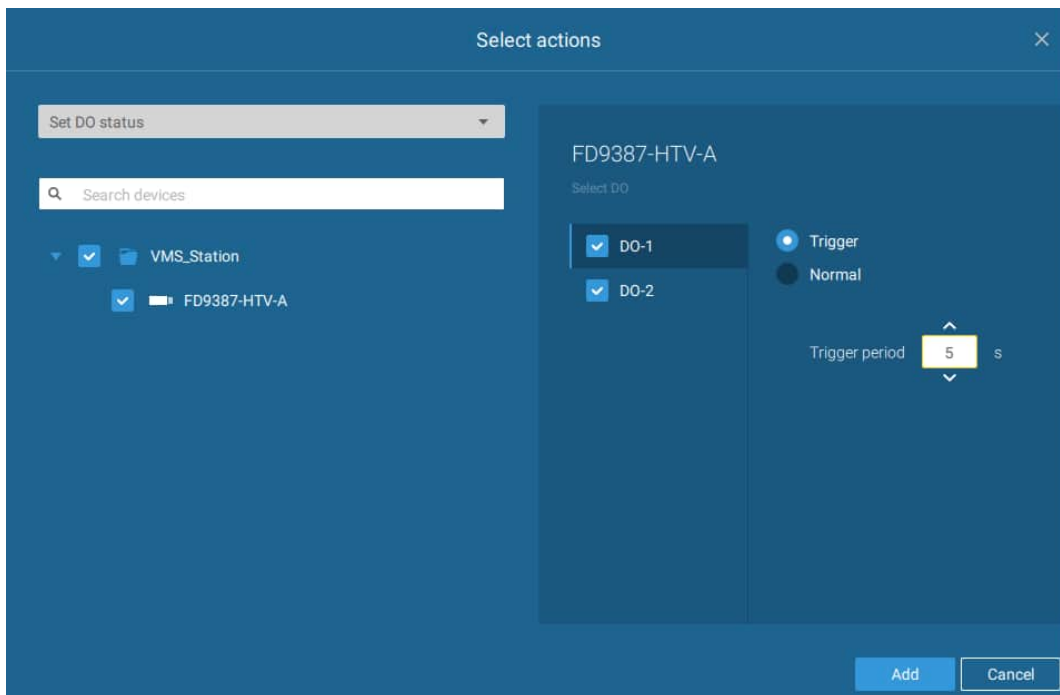

The [Send live streaming](#) action will bring up a video prompt to the Alarm tab window, showing the realtime video feed from a specific camera.

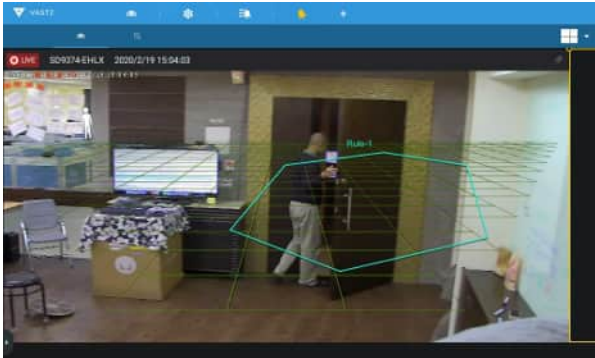

The [Go to camera presets](#) requires you to configure preset points on a PTZ camera before the Alarm configuration, such as a speed dome. Once triggered, the PTZ camera lens will move to a preset position.

The VAST server automatically disables unavailable options. For example, when the DO option is selected, the cameras that do not support DO connections will be hidden.

The [Send email](#) opens a configuration page where you should enter valid email addresses as sender and recipients. It is required that you configure an SMTP server for mail delivery in Settings > SMTP. Enter Subject and contents. Select the checkbox for including a snapshot of the event. When done, click Add to enable the action.

The [Go to E-map](#) opens a pre-configured E-map of where the triggering condition occurs. The user can then click on the camera icon on the E-map for an instant viewing.

The [Add bookmark](#) function saves a video clip of a 10-seconds length. Once triggered, you can open a new view tab > Search > Bookmark search to find the existing bookmarks. The bookmarked video clips will not be recycled during the storage cleaning cycles.

The **Sound the alarm** action provides 5 alarm sounds that will be sounded on the VAST client or server. Your VAST client or server should have speakers for playing the audible alarm.

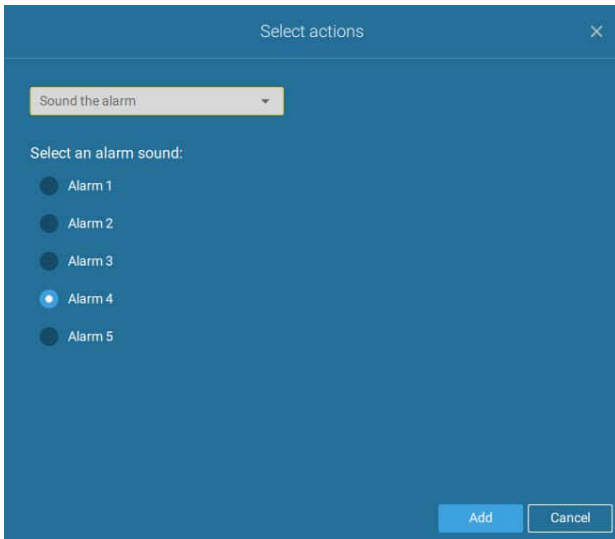

A reachable Mail server and Email accounts must be provided before you can apply the settings.

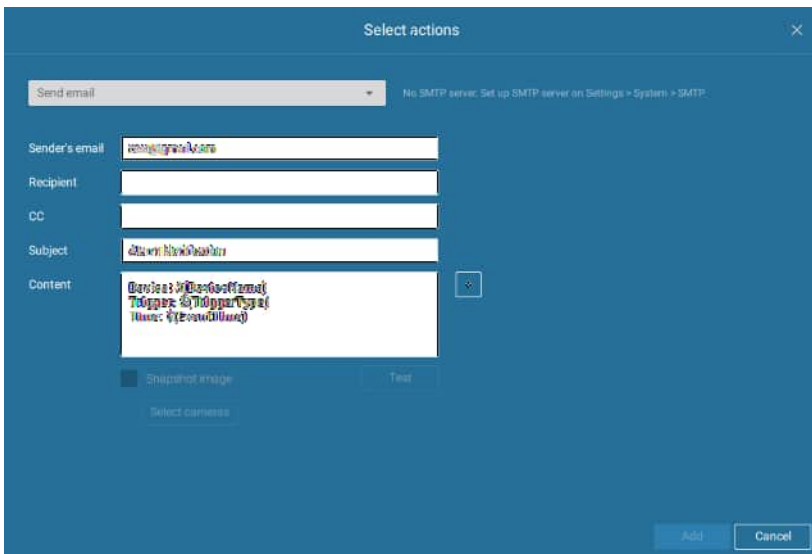

On the **Schedule** page, you can select to activate or de-activate alarm triggers throughout a specific timeline. For example, in some situations you can disable the alarm triggers during the office hours, and choose to enable the triggers only during the off-office hours.

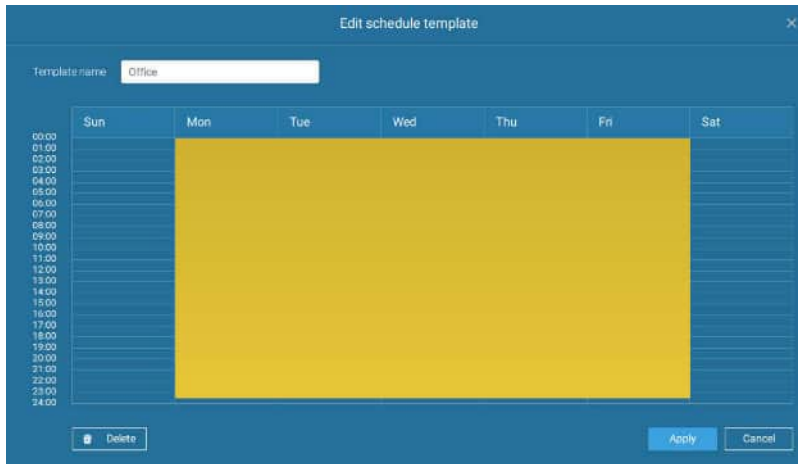

Click on any of the options on the Schedule panel for the alarm to take effect: Customize, Always, or Add a schedule.

You can manually create a effective time template using the New template button.

Save as a template...

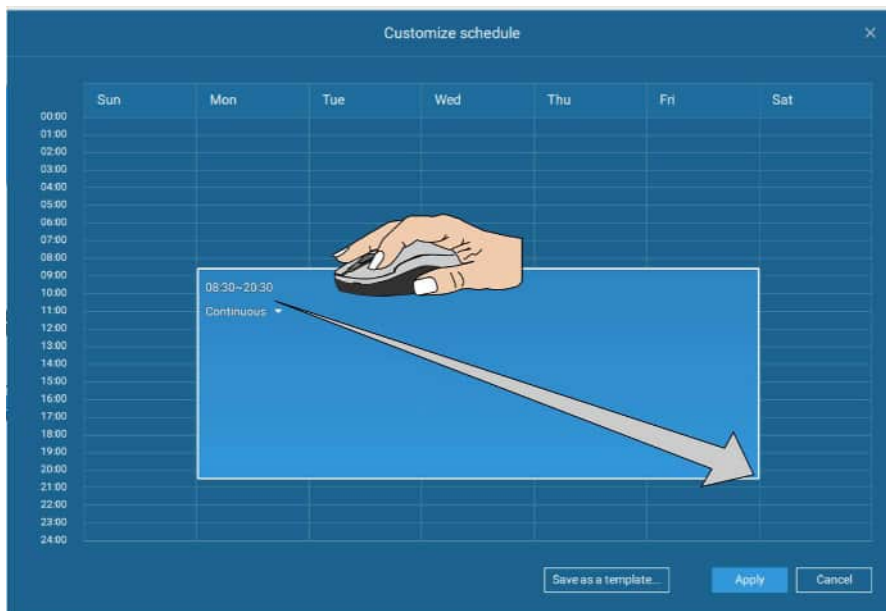

Click and hold down on the time cells, and drag the mouse to include the time span of your preference. The minimum selectable unit is half an hour. You can select multiple time spans on the template. Enter a name for the template, and click Add to save your template.

The same configuraion window apply to both the Schedule template and the customize schedule windows.

Make sure a Schedule mode is selected when you leave this configuration step.

Enter a name and instructions for users to follow, and then click Add to complete the Alarm setting.

All configured alarms will be listed on the Alarm settings page.

Group Alarm

Multiple triggered alarms can be presented as group alarms. Alarms triggered by the same event type, and by the same camera can be grouped together. In this way, multiple similar alarms can be listed under one entry.

On the alarm list, click the **Group alarm** button to display the alarm group.

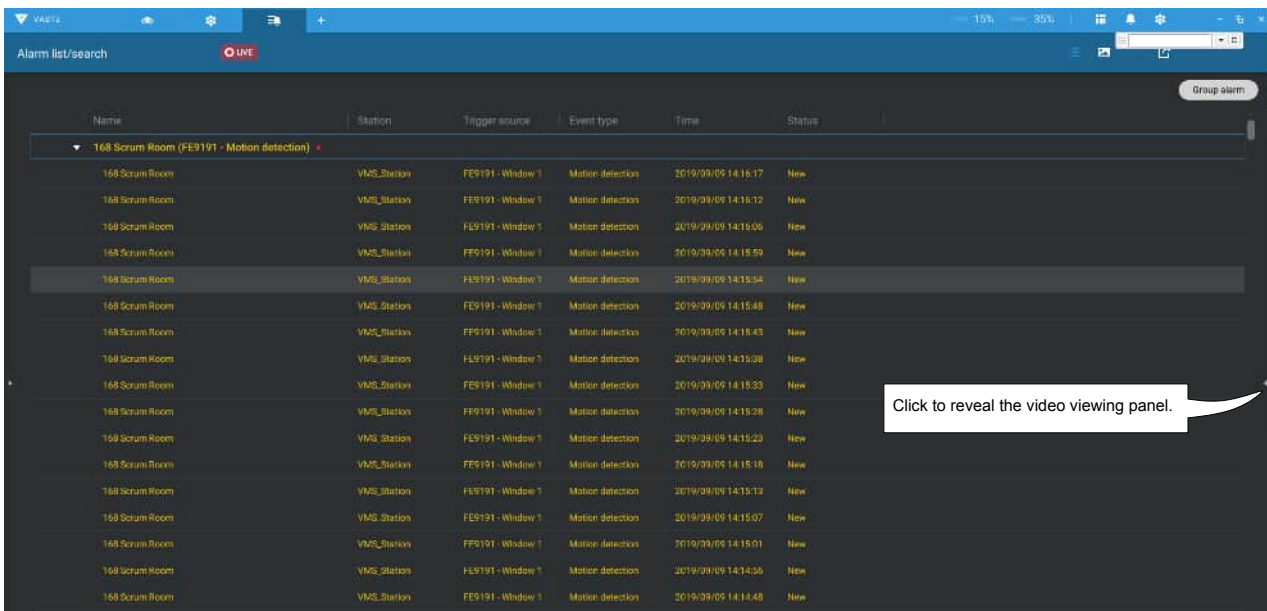

In the list mode, you can expand the right-hand-side panel. The video of the latest alarm will display.

When the alarm-triggered action is configured as sounded alarm, you can mute all alarms in the group by clicking the alarm sound icon.

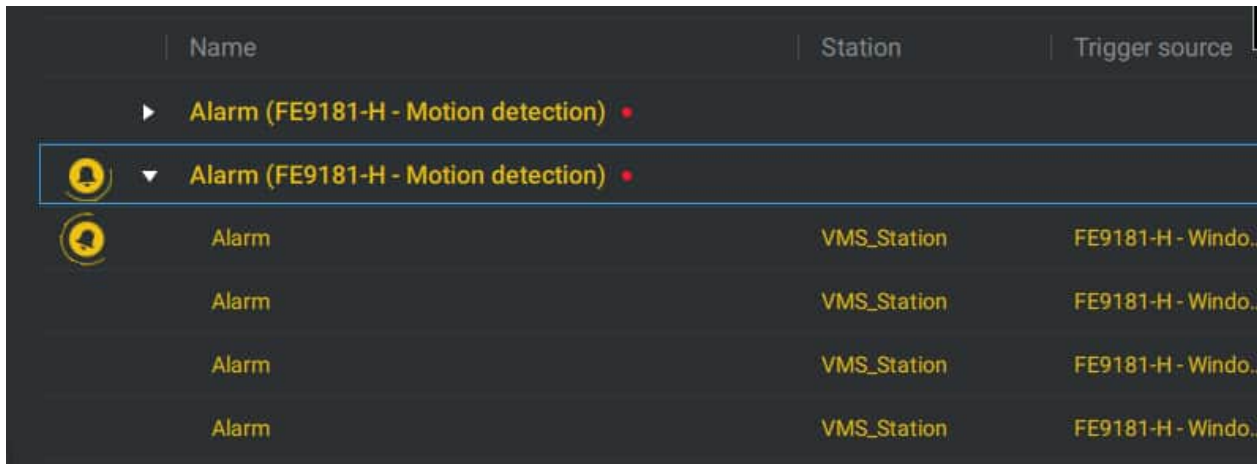

The same applies to the thumbnail view. To leave the group alarm view, click the Group alarm button again.

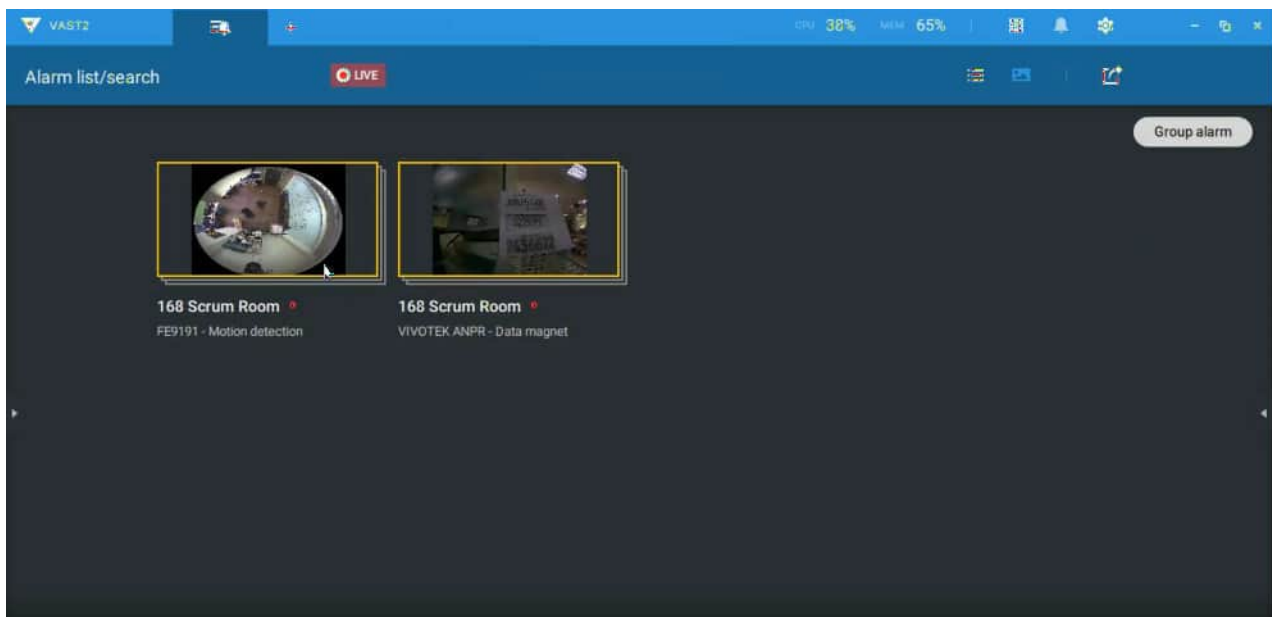

When the alarm action is set to "Send live streaming," the videos coming from the same camera will occupy only one view cell.

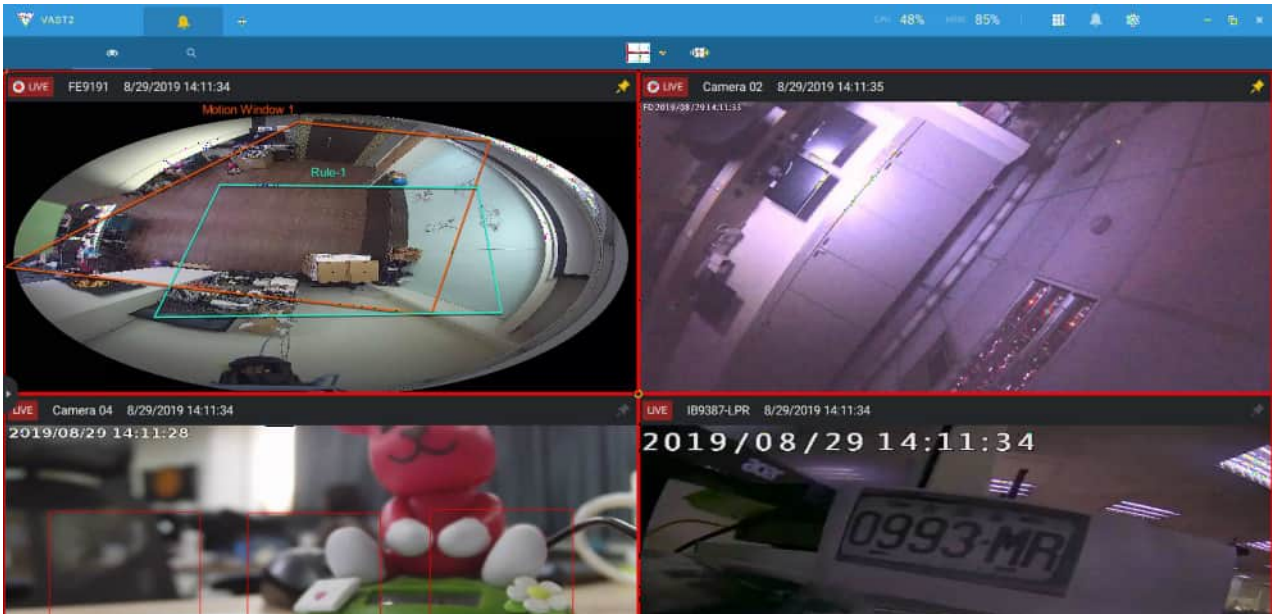

In the Alarm tab window, use the thumbtack  button to freeze the current screen. If thumbtacked, the other incoming alarms will not affect the current screen.

On arrival, the latest alarm will display with a blinking red frame. A selected view cell will display with a yellow frame.

The alarm notification can be turned off by clicking on the Alarm tab. Use the slide toggle to do so. You can also select to let the notification automatically turn on after a configurable span of time. Enter the number in the mins field. The max. time span is 9,999 minutes.

The notification configuration is kept on the client computer.

When the Alarm notification is turned off, the Alarm tab icon is greyed out .

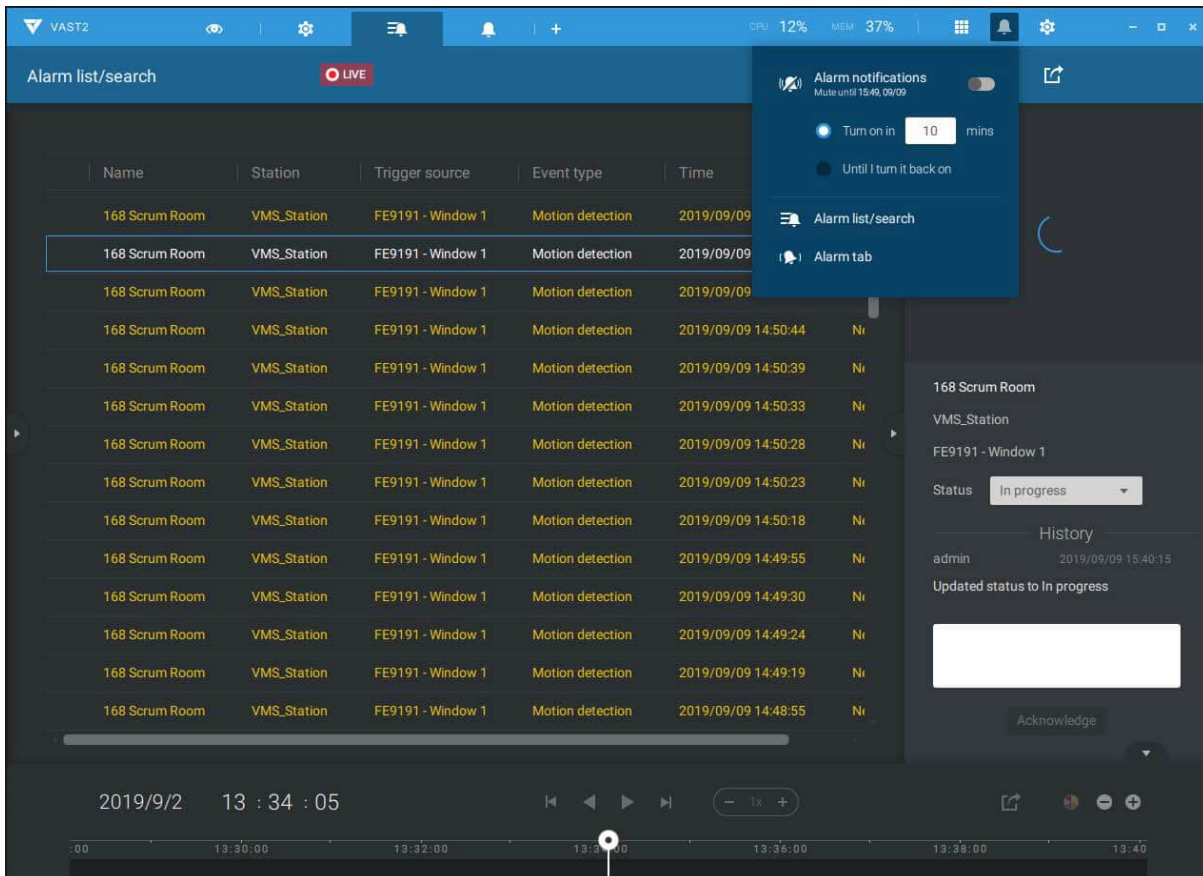

Note that the default for the alarm notification is "Until I turn it back on." If you turn off the alarm notification, you need to re-activate it after you turn off the notification the first time.

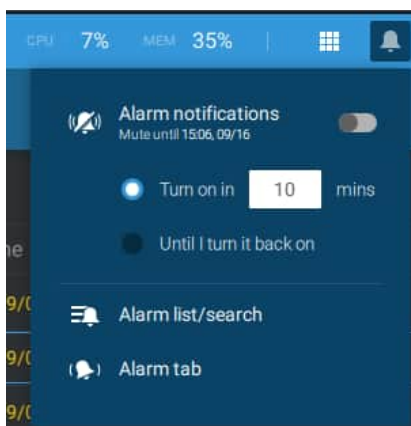

2-2-15. Search Panel

The Search panel is accessed via the Search  button. 2 key functions are provided: Search by **POS** transaction, and Search by **Bookmark**.

1. Search by POS transaction: The VAST station can collect coordinated database information from a POS machine. This function provides access to the video clips associated with the sales record on the POS machine. Details of transaction can be listed on screen so that a manager can see the live view when controversial events occur.

To search the POS-related recordings,

- 2-1. Select the VAST station which the POS machine is connected to (via the Settings > POS configuration).
- 2-2. If you know the approximate time of occurrence (bill void, content adjusted, shortage of products, and other frauds), use the calendar to select a time span.
- 2-3. Select a POS machine, if there are many.
- 2-4. Select a search condition, such as item name, subtotal, or the transaction number.
You can use the >, <, or = signs to specify the amount you are searching for. For example, key in >100 for amounts larger than \$100.
- 2-5. You can click the add button below to append more search conditions.
- 2-6. When done, click the search button.

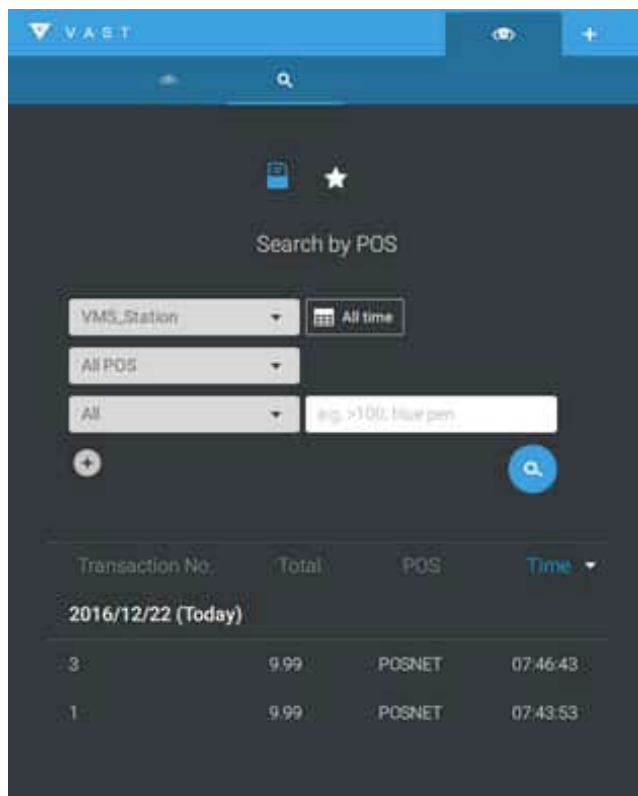

NOTE: The Alarm search panel is replaced by the Alarm list function. The Alarm list is accessed from the top tool bar.

2-7. Click on any of the search results. Details of the transaction will display along with the recording of the time of occurrence.

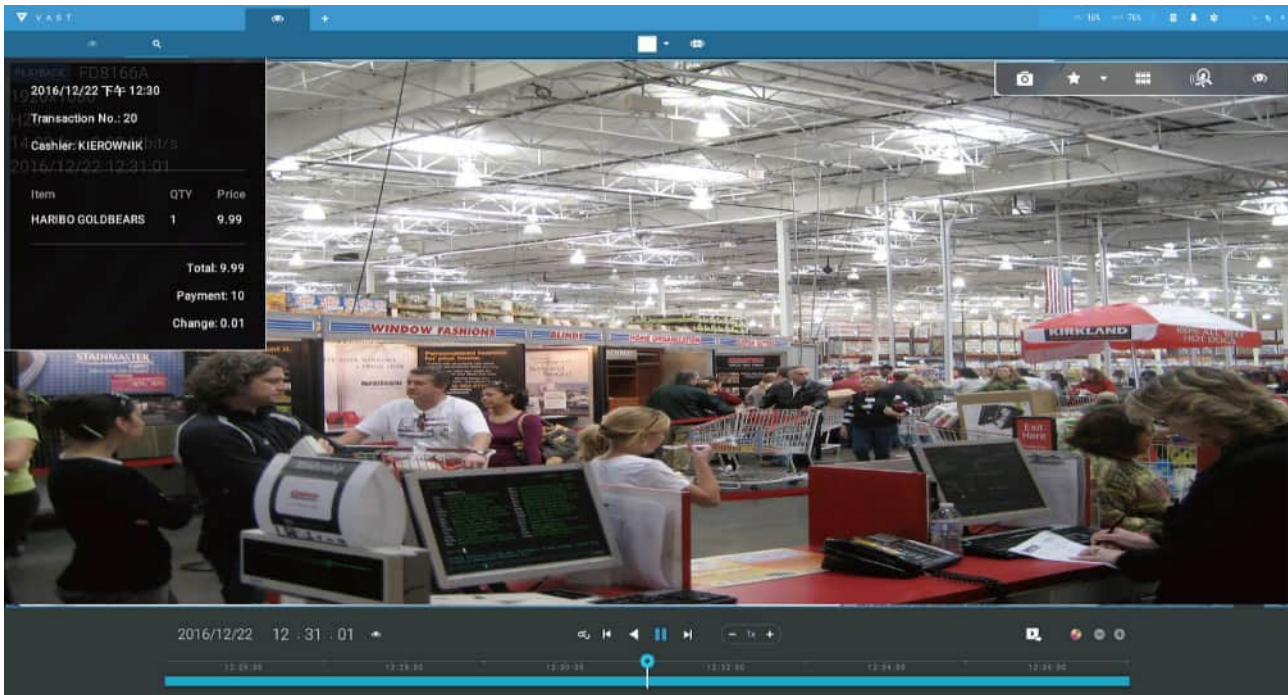

2. Search by Bookmark: Bookmarks are manually created when users review recorded videos in the Playback mode. Each bookmark comes as a 10-second video clip.

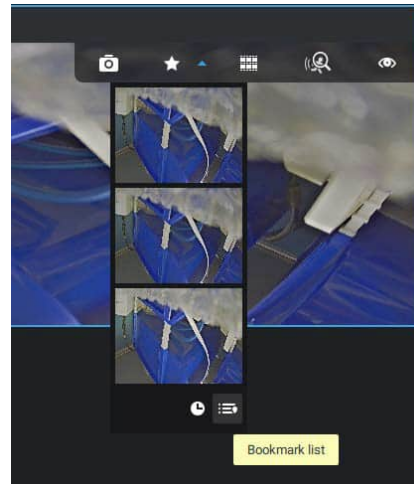

In the Bookmark search panel,

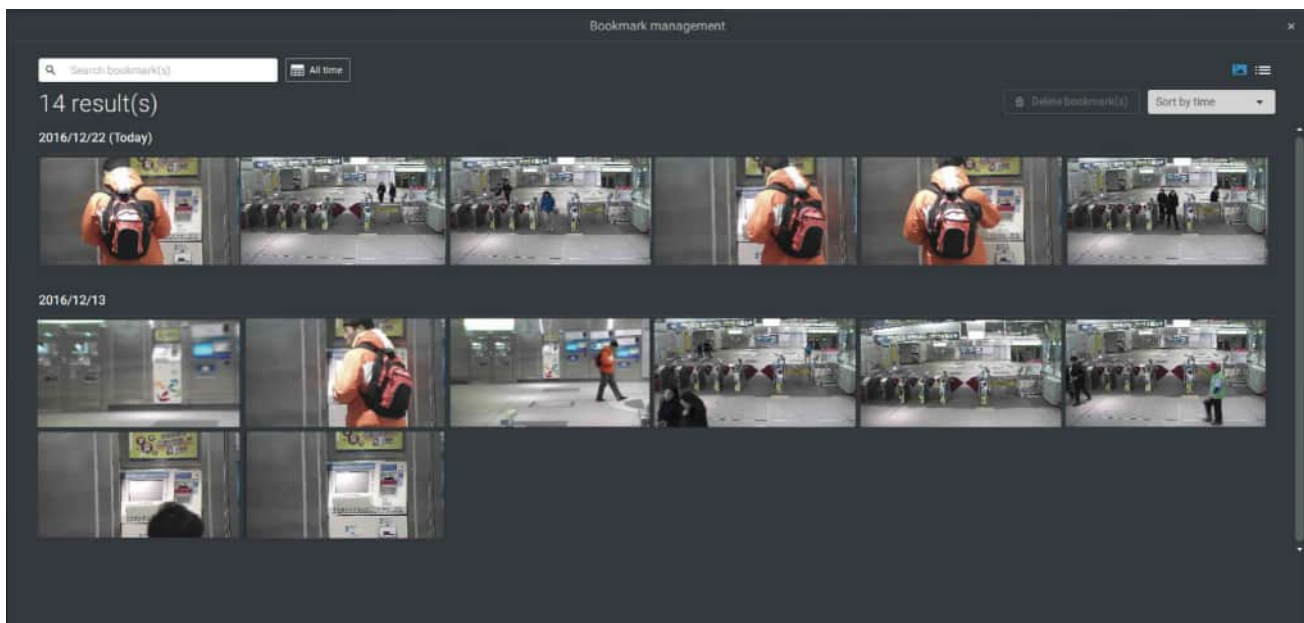

Click the Bookmark search  button. The Bookmark Management window will prompt. All existing bookmarks will be listed with thumbnails.

- a. On this window, you can specify a range of time during which the video streams were recorded and its points in time were bookmarked.
- b. You can then click on a bookmark to display the short video clip extracted from within the recorded video. The default is 10 seconds.
- c. To remove an existing bookmark, left-click to select an entry, and then click the Delete bookmark(s) button. Bookmarks will be indicated as "Invalid" if the videos where the bookmarks were appended were erased, e.g., when the original recording was erased by cyclic recording.
- d. Currently you can search for bookmarks using the name of the camera.
- e. You can also select the display types for the bookmark search in either the thumbnails or list mode.

2-2-16. Smart search

The Smart search function enables a quick glimpse of activities occurred within a user-configurable detection area from the recorded videos. **Smart search** is available in both the **Liveview** and **Playback** mode.

Click to select a camera view cell. Click on the [Smart search](#) button  to enter the Smart search window.

There are two Smart Search modes: Smart search II and Smart search I. The Smart search II applies to the recordings of the cameras that come with the [Smart Motion, and other VCA](#) capabilities. There are two kinds of metadata polled from camera VCA packages:

1. [Motion cell](#): Pixel-based information. The search results will include all moving objects in the scene.
2. [Object information](#): Human-based information. If People detection is selected, only objects detected as human will be displayed as the search results.

Please refer to VIVOTEK's website pages that are related to the Smart motion and Smart VCA features for the supported cameras.

Below are short description for the Line Crossing, Loitering, and Intrusion detection functionality:

Line Crossing Detection

The Line Crossing detection detects one or multiple persons crossing a virtual trip-wire. The traffic direction can be assigned on screen for persons passing the line in one specific direction or in both directions.

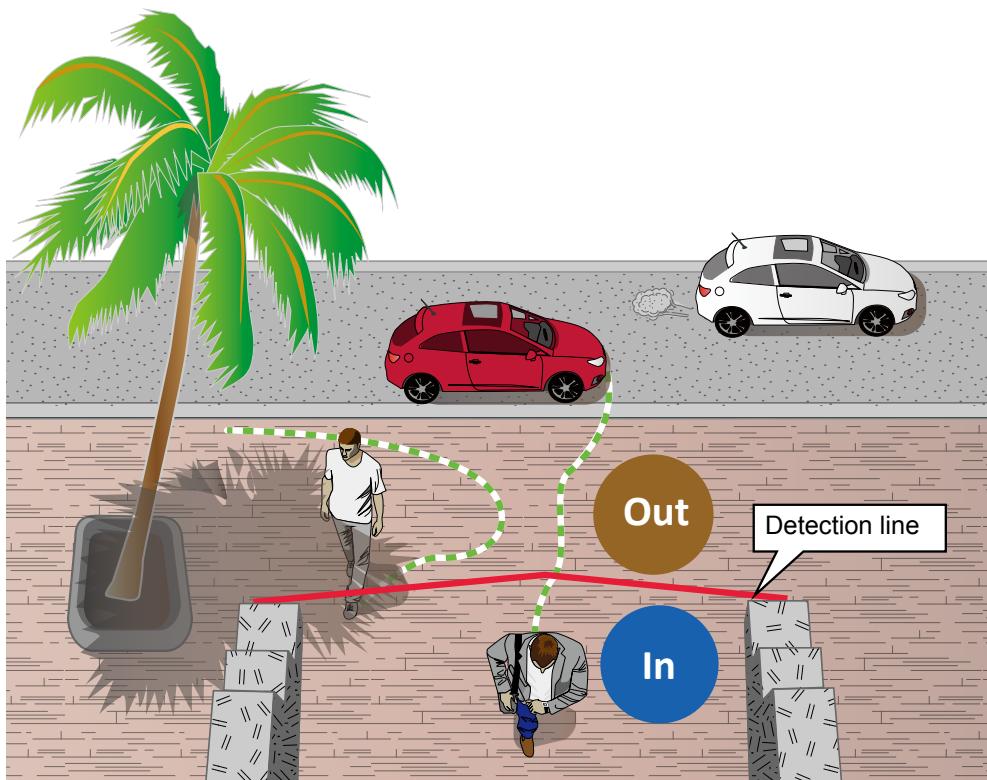

The applicable scenarios of this feature can be:

- * Detects someone who enters a drive way, entrance, or exit through the virtual line.
- * Detects and triggers an alarm in a predetermined direction.
- * The detection line can be used as a fence boundary to know if someone has crossed the articulated line around a perimeter.

Loitering Detection

The Loitering detection can be used to detect a person or a group of people lingering in an area for longer than a preset time threshold.

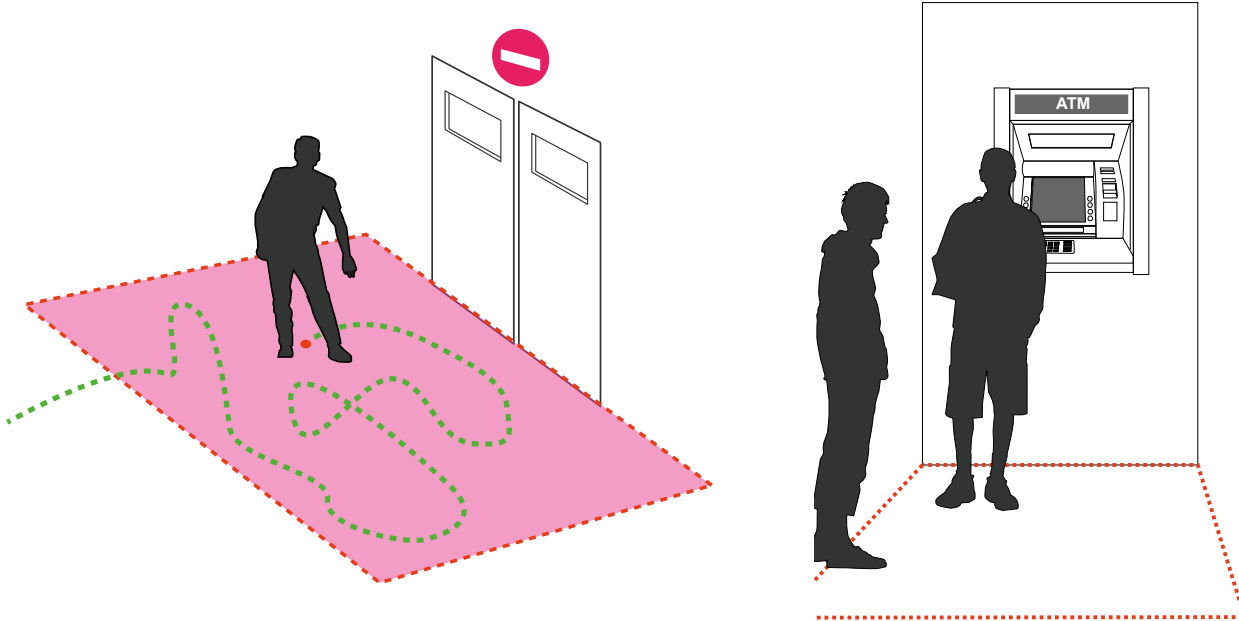

Intrusion Detection

VIVOTEK Intrusion Detection can be used to detect people entering or leaving a virtual area in the camera field of view.

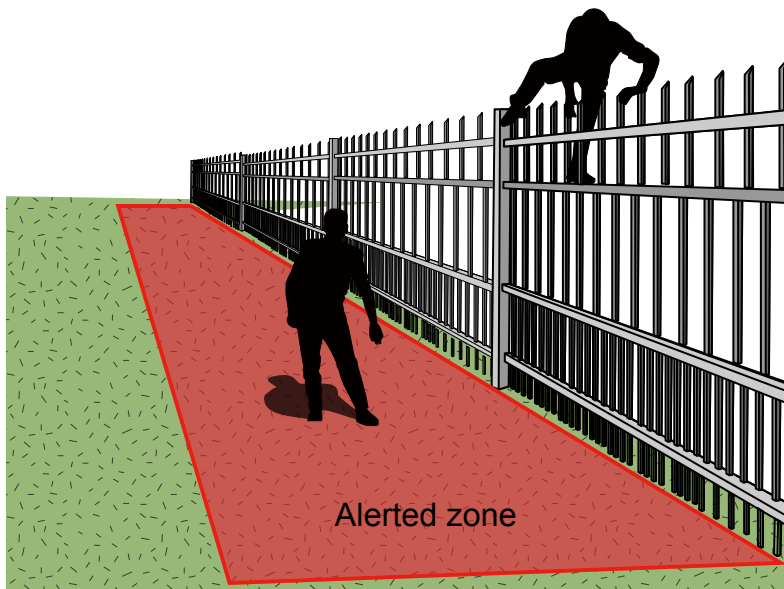

The applicable scenarios of this feature can be:

- * Detects when a person enters a bank vault or school after the office hours.
- * Detects when a person leaves an emergency exit or fire escape, or any place that is normally forbidden from access.

To use Smart search,

1. Use the date and time selectors to specify a time span on which to perform the Smart search.
2. Select a Type (Smart motion, Line crossing, Loitering, or Intrusion). Selecting Line crossing detection may require you to adjust the position of the detection line.
3. There are different parameters for each detection Type. Refer to each VCA feature's documentation for details. You can tune the parameters for each VCA feature. See next page for the configurable parameters.

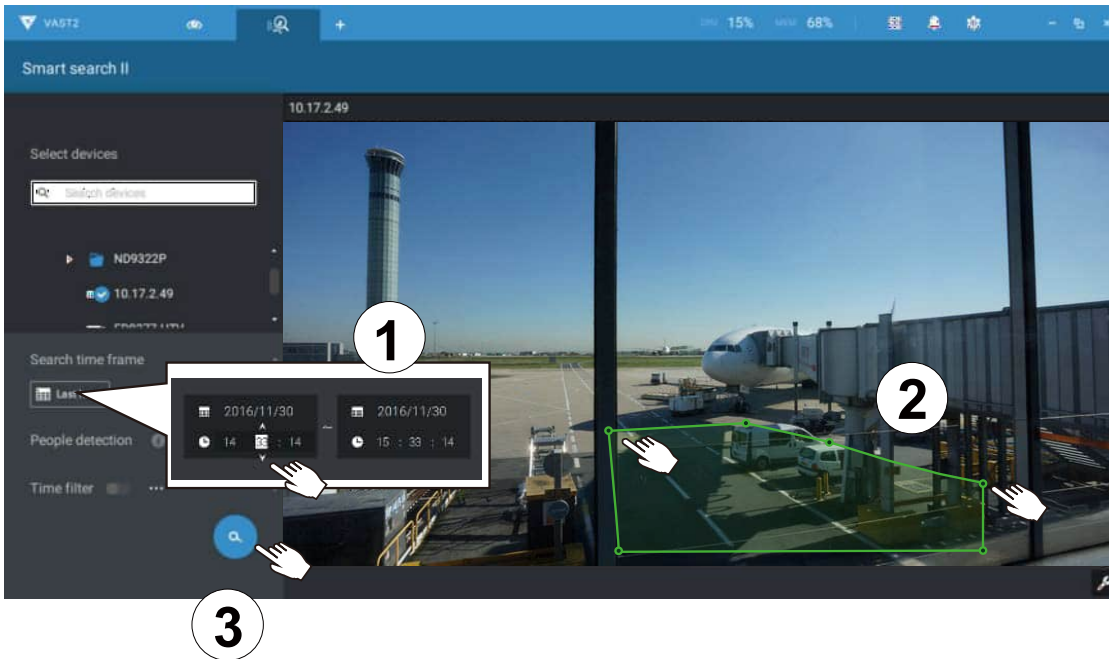

4. You can draw one polygon with multiple mouse clicks to include areas where activities of your interest have occurred. You can draw one or more cross lines for Cross line detection. Double-click to close a polygon.
5. Click the Search button.

Search parameters:

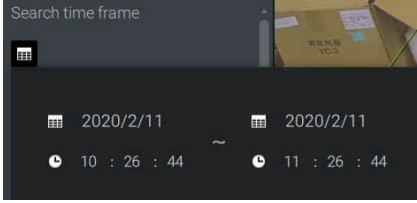
Search time frame	Use the calendar tool pane to specify the time span within which the activities in scene will be searched. 			
Type	If the selected camera supports multiple Smart VCA detection features, the supported types will be listed: Smart motion, Line crossing, Loitering, or Intrusion.			
Parameters (determined by Type)	Smart motion	Line crossing	Loitering	Intrusion
	People detection*	People walking direction	Stay time	Direction: Into the zone / Leaving the zone
	Sensitivity**			
	Time filter			
* People detection	People detection enables the display of the alarms detected via the human silhouettes algorithm. This can be used to filter out video analytics alarms that are not related to human activities, such as swaying vegetation, or small animals.			
** Sensitivity	Configure the sensitivity for the detection of the activities in scene. Low for near scene, high sensitivity for long distance scenes.			

Note that different cameras support different VCA functions. Please refer to the documentation for Smart VCA or Smart tracking features, such as the [Smart VCA User Guide](#).

IMPORTANT:

Running Smart Search II requires cameras that support the following:

1. Smart motion.
2. Firmware version above 0113d, 0117b or 0100i (Authwebsocket support is needed)
3. VCA package version above 6.1.3a.

NOTE:

- * Smart search II supports people detection whether the camera comes with a Smart motion license or not. However, the Line crossing, Loitering, Intrusion features will not be available.
- * With a valid VCA package and license, the abovementioned features will be available in the Smart search II.

In most cases, it is presumed that you have configured VCA detection zones and detection rules such as lines to detect people crossing. You can also configure a detection zone or lines on the VAST server and then search for the detection results from the recorded videos.

If your camera supports Smart VCA features, you can manually create detection rules on the configuration screen. Note that you may not need to do this if you have already configured detection rules on the camera.

1. Select a VCA camera.
2. Select a VCA type from the pull-down list: Smart Motion, Line crossing, Loitering, or Intrusion. For a camera that supports only one VCA feature, such as Smart tracking on a speed dome, there is no "type" option.
3. You can then draw a detection zone, or detection line on the screen.
4. Select a time frame using the calendar tool.
5. Select to enable or disable the People detection feature and configure the Time filter, or other parameters.
6. Click the **Search**  button.



4. The search results display as the snapshots of the associated video clips. Click to playback the video clips with activities in the detection zones.

Hover the screen with your mouse, and the length of each video clip is displayed.

Note that unless interrupted, the playback continues with all detection zone clips, by continuing to the successive clips.



Smart search II is available only for newer line of cameras that come with **Smart Motion detection** and other **Smart VCA** features. Smart search II has the following benefits:

1. **Faster search:** Metadata is saved with videos coming from the cameras running Smart VCA detection. With the help of the metadata, the search focuses on the effective alerted vectors and the adverse effects, e.g., headlights causing dramatic contrast or small animals passing through, have already been eliminated by the camera. The search can be more rapidly completed.
2. **People detection:** The search can be conducted for human activities only. Activities matching the silhouettes of human will be considered as effective results.
3. **Multiple-point polygon:** Users can select a region of interest by drawing a easily-configured polygon. In addition to the pre-configured detection rules on VCA cameras, users can create their own Smart VCA Detection rules on the VAST search panel screen.

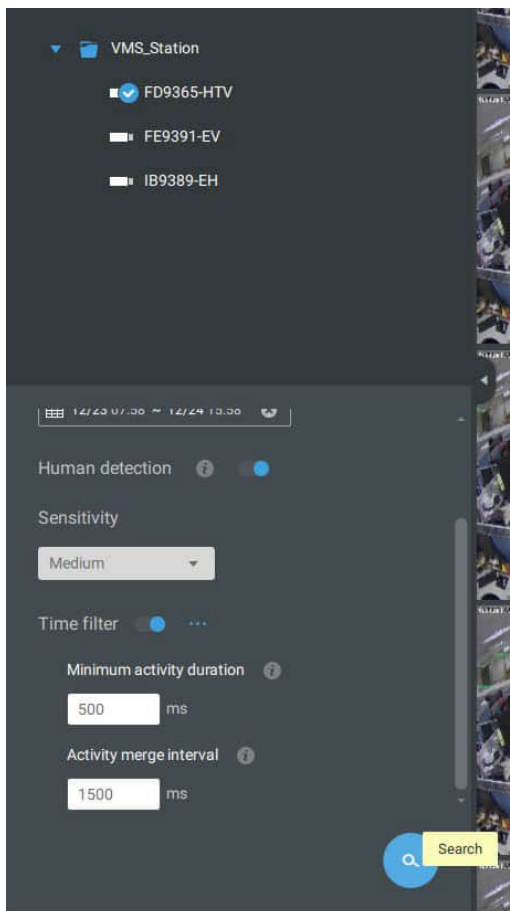

You can specify the time span, People detection, Sensitivity level, and time filter parameters in a Smart Search II panel.

5. You can then click to open any clip of your interest. Each marked event clip will be indicated by a lighter color on the time line. Select and double-click on a video clip, and then right-click or select the bookmark or snapshot functions from the upper-right.



Move your cursor to the upper right corner of the playback window to display the Snapshot and Bookmark buttons. Use them to configure the current play time as a bookmark or take a snapshot.

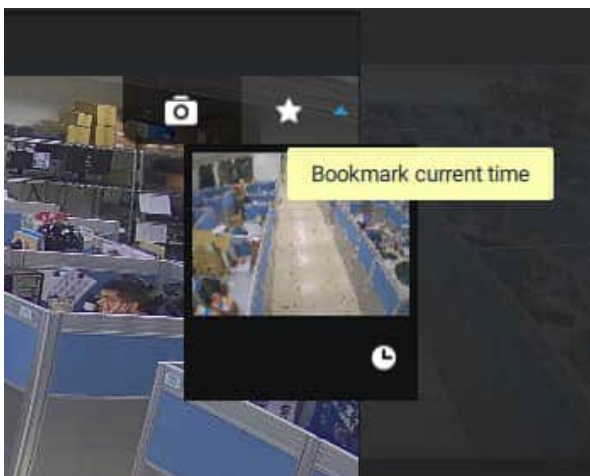

While in the full-screen Playback window, you can right-click to select or deselect the display elements including motion cells, tracking block, and tracking dot.

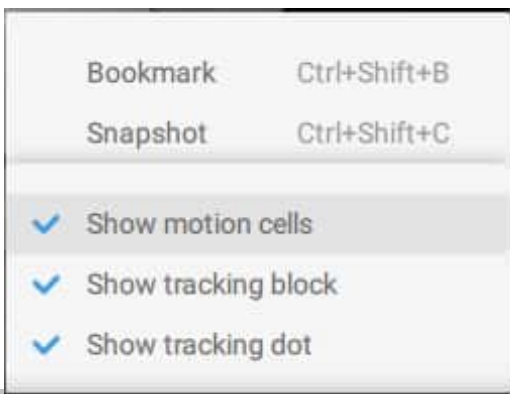

6. If you find important events, use the Export function to mark the start and end points on the timeline to export a video clip. Use the pull tabs on time line to determine the export length. By default, the export length is 2 minutes long.

The playback control in the Smart search window is identical to that on the Playback window.



Different events on the timeline are indicated by tags of different colors. Click on the event highlights button to verify their colors.

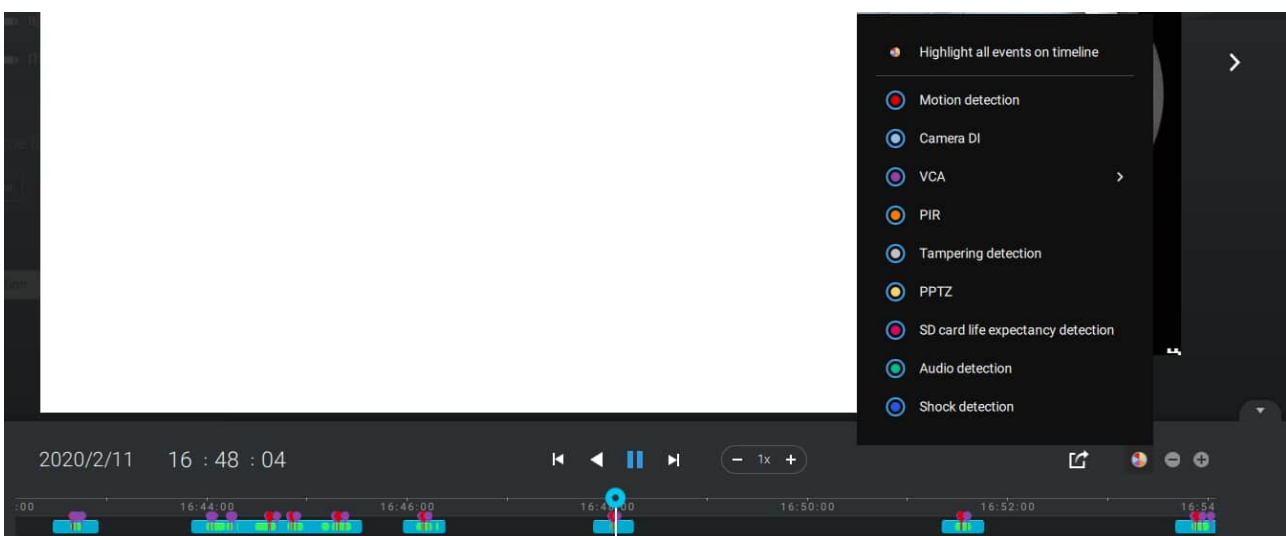

2-2-17. Tour

A tour can be configured to consecutively display multiple views. A tour allows users to quickly glimpse through many view cells in a timed pattern. As a tour can contain multiple views, you should design and configure camera views before configuring a tour.

To configure a tour,

1. Click on the Add a camera tour  button.
2. Click the Add button.

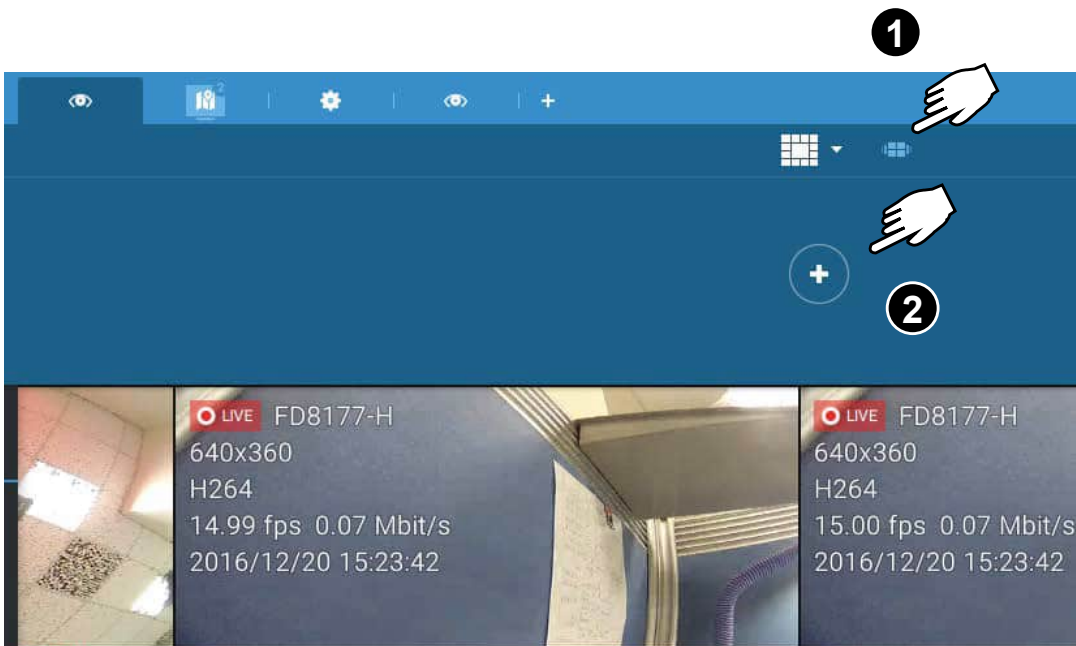

3. Enter a name for the tour.
4. Single-click to select a view. Select multiple views each by a single click.
5. Click the Add Tour button.

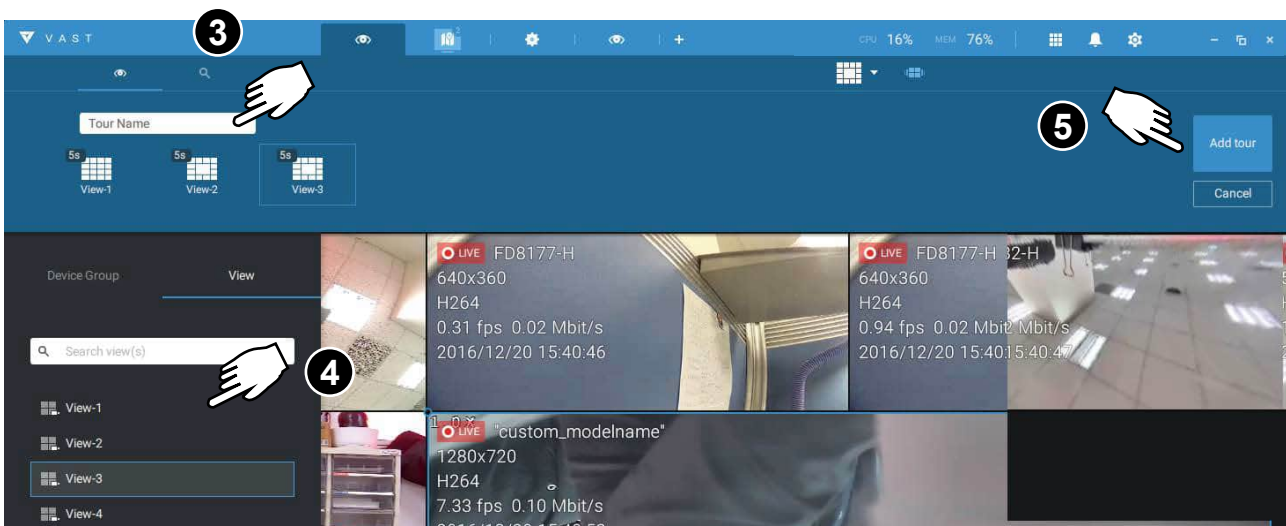

The default for the duration of the display of each view is 5 seconds. You can right-click on each view to display the Duration of each view. You can apply the same duration of all views, or allow each view to display on screen for a different span of time.

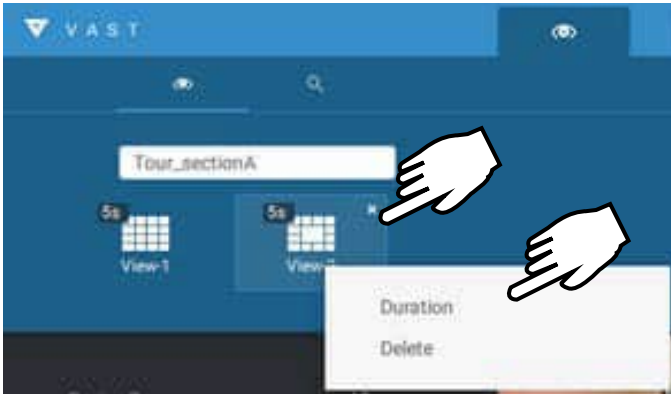

You can enable the **Audio tour** option which plays the audio inputs from each view cell for a specific period of time.

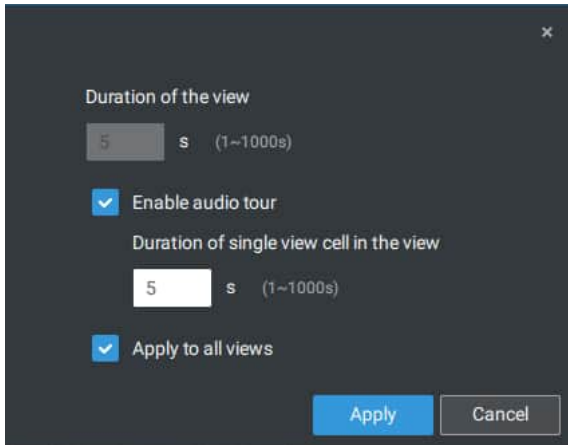

Mouse over a configured tour, and then click to start a tour.

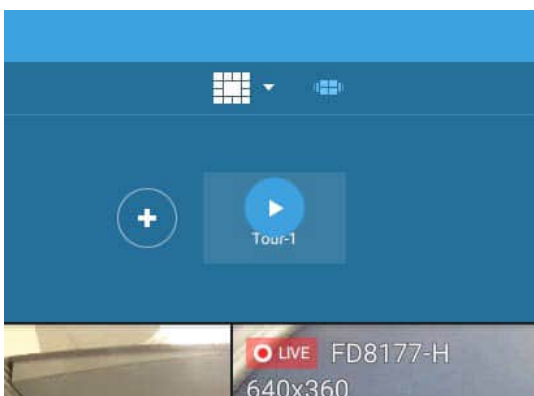

When playing a tour, and you want to stop the tour, you can left-click or right-click on the screen. Click the Tour icon  again to return to the singular live view.

2-2-18. Thumbnail search

The Thumbnail search function is like doing a post-production editing in film making. Screens from across different time spans are shown to facilitate the search for evidence.

Click on the Thumbnail search button  to enter the Thumbnail search window.

The default time span is 100 minutes, starting an hour earlier of the current system time.

To use Thumbnail search,

1. Use the date and time selectors to specify a time span during which you suspect the event of your interest has occurred.
2. If preferred, tune the interval and clip size. The default length for each clip is 10 seconds.
3. If you find a clip might contain an event of your interest, you can click to select, and then slide left and right to watch the activities within.

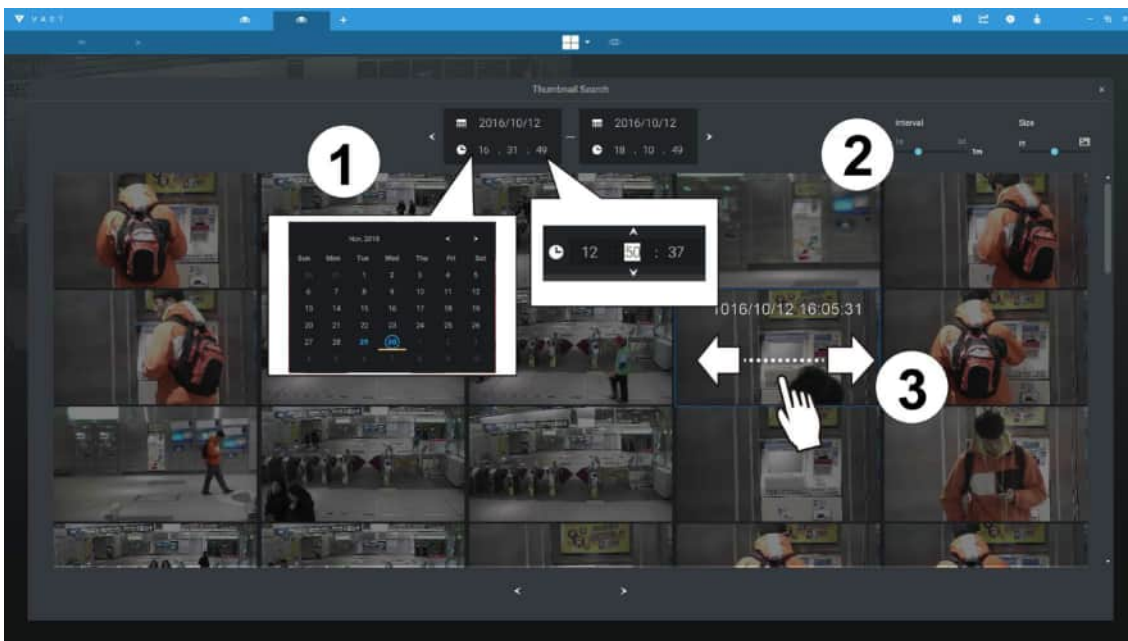

4. Hover your cursor to the lower center of a clip to display the Play and the More snapshots options. If you click More snapshots, another window will prompt to display all frames within the clip.

When you select to display the clip details (specific time span), the time span and the interval information will change accordingly.

When you find an event of your interest, you can play that video clip and use the export function on screen to output the evidence. You may also place a bookmark on the timeline.

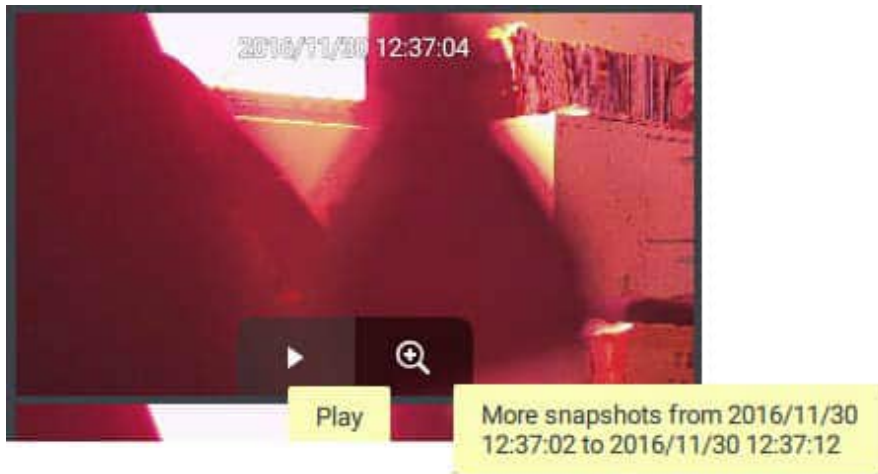

Chapter 3 Applications:

3-1. I/O DI/DO Devices: IO Box and Related Configuration

Use the software utility that comes with the IO box, e.g., Advantech's Adam/Apax.NET utility, to configure IP address, and test the DI/DO connectivity. The connections to external devices should be completed before configuration on the software.

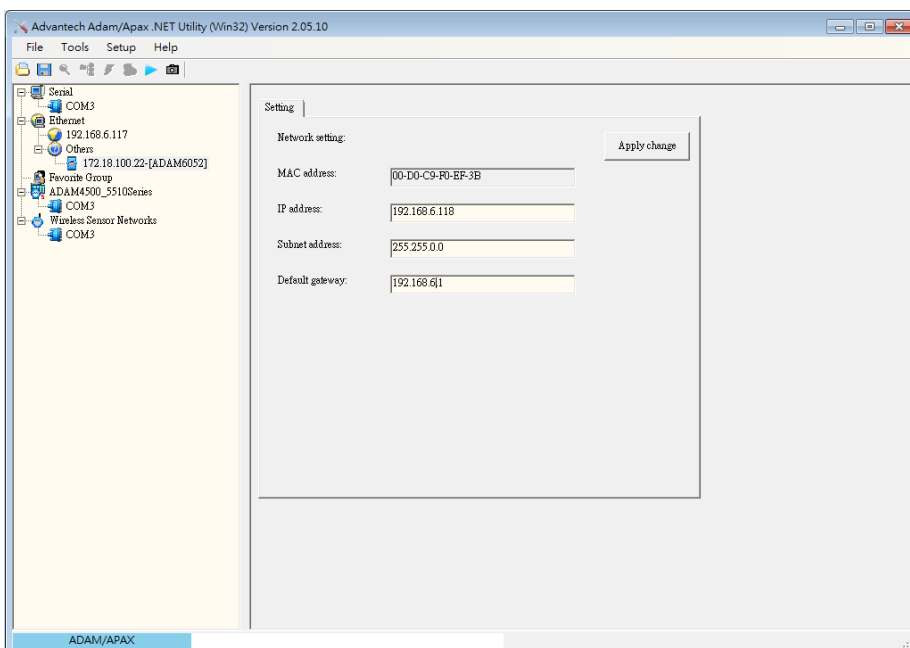

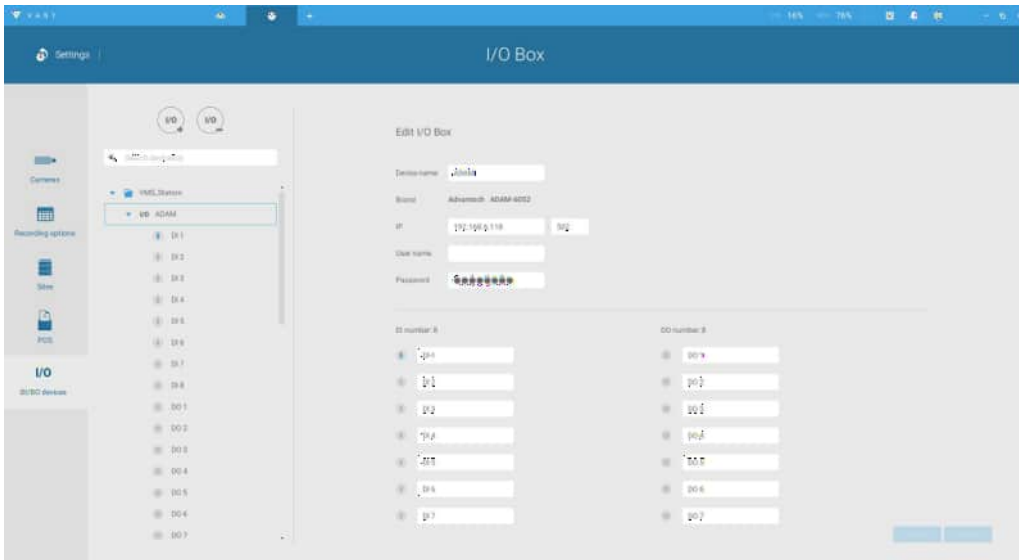

Enter Settings  > Device > DI/DO Device. Click the add I/O button on top.



Enter the I/O box's IP address and credentials, and select the correct model name from the pull-down list on the right. Click the **Apply** button to proceed. The current I/O connections are also displayed on screen, such that the status is displayed when DI pins are connected to detection devices.

Configuring I/O Box DI/DO as a Trigger or Action in Alarm

Enter the Settings  > Alarm window. Click the Add alarm  button on top.

Select the External Device event , and then click the Add trigger  Add trigger button.

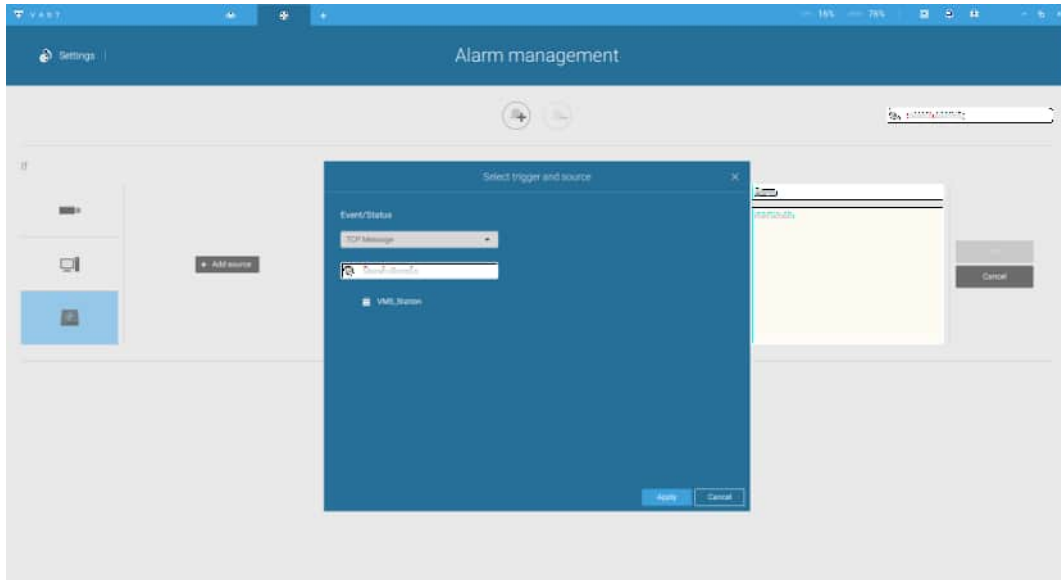

The **Select trigger and source** window will prompt.

Select either the I/O Box DI or DO as the triggering source.

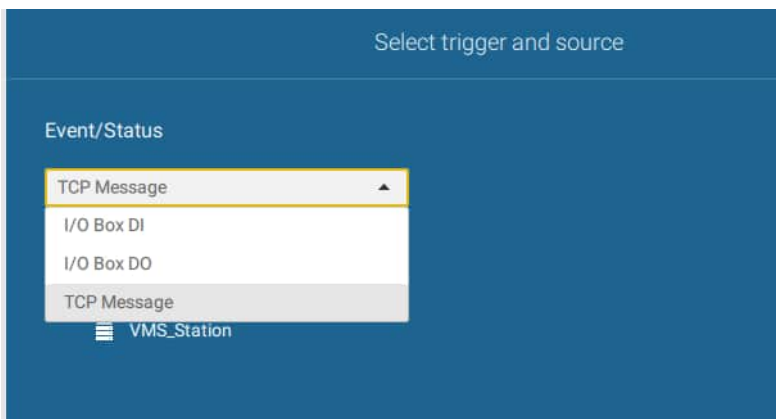

Select one or multiple DIs as the triggering source and click the **Apply** button.

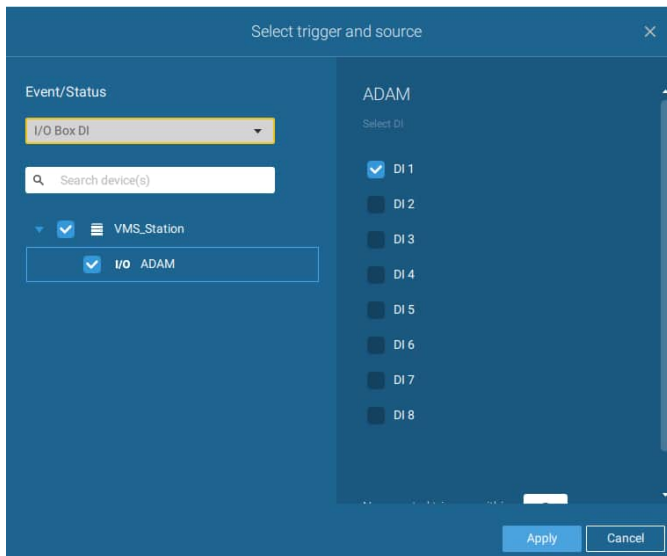

Click Add action **+ Add action**, and select a corresponding action, such as sending live streaming, record videos, trigger a DO, sending an HTTP request, or sending an Email. When done, click the Add button.

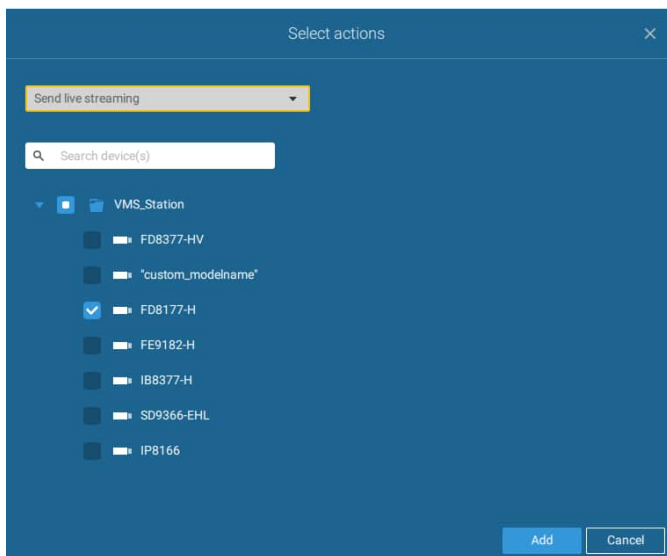

Configure a schedule during which the Alarm configuration will take effect. If no special time span is needed, you can simply select Always.

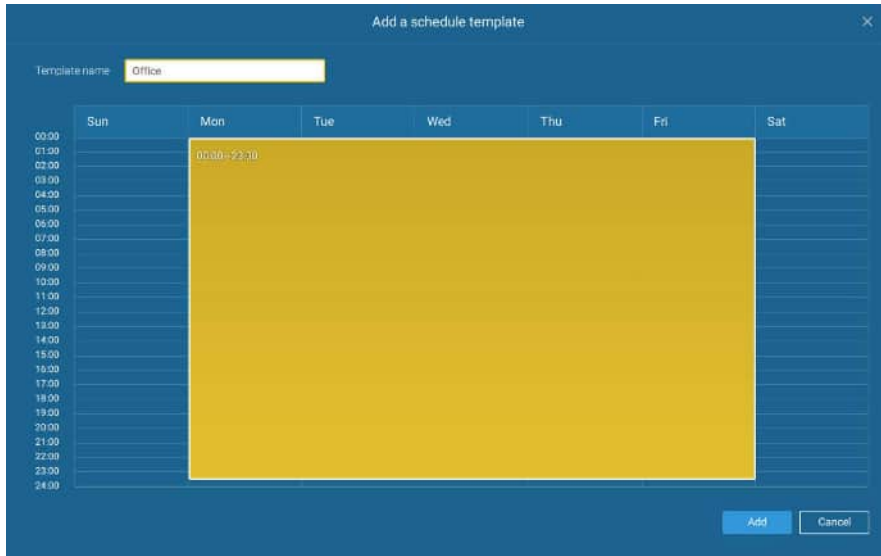

Enter a name for your Alarm, and add description for your configuration, e.g., "intrusion detected on the front door." When done, click the Add button. The Alarm configuration takes effect immediately.

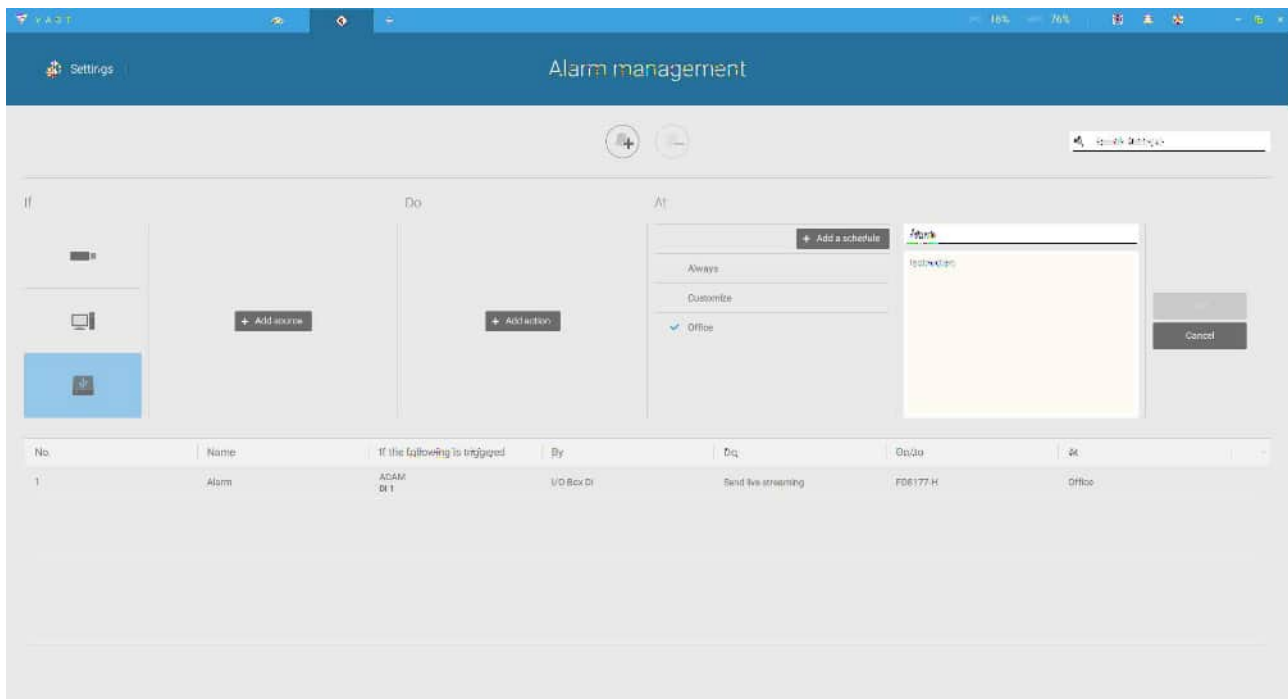

NOTE:

If an I/O module is started later than the VAST server, you may not be able to access the I/O module. You should then re-start the VAST service.

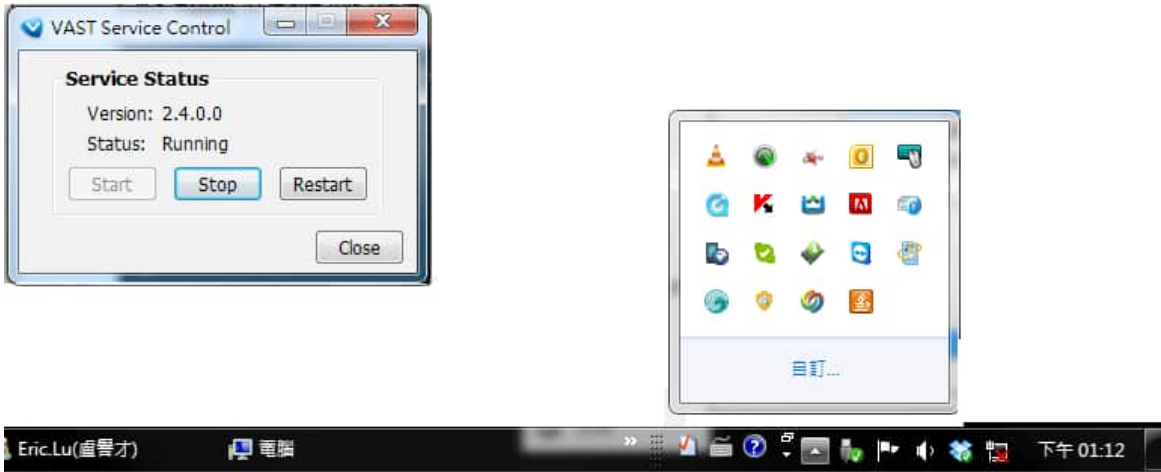

3-2. Configuring Redundant Servers - Failover

VAST2 servers can be configured into two groups: Active and Redundant. The Active group performs daily recording and monitoring tasks, while the Redundant group acts as the standby servers. In the event of server failures, the Redundant group becomes active, and takes over the recording task.

The Redundant server group configuration consists of the following:

1. One VAST2 server designated as the **CMS** (Central Management server) VAST central management server. Another VAST server can serve as a CMS failover server.
2. At least one VAST2 server in the **Active** group.
3. At least one VAST2 server in the **Redundant** group.
4. Gb/s network or higher-speed connections among the servers. All Active and Redundant groups can reside in different subnets, provided that static IPs are configured for these servers.

IMPORTANT:

For a Redundant server configuration, you must first enlist VAST servers in the **Sites** configuration page before configuring the Redundant server groups. See the **Sites** configuration page.

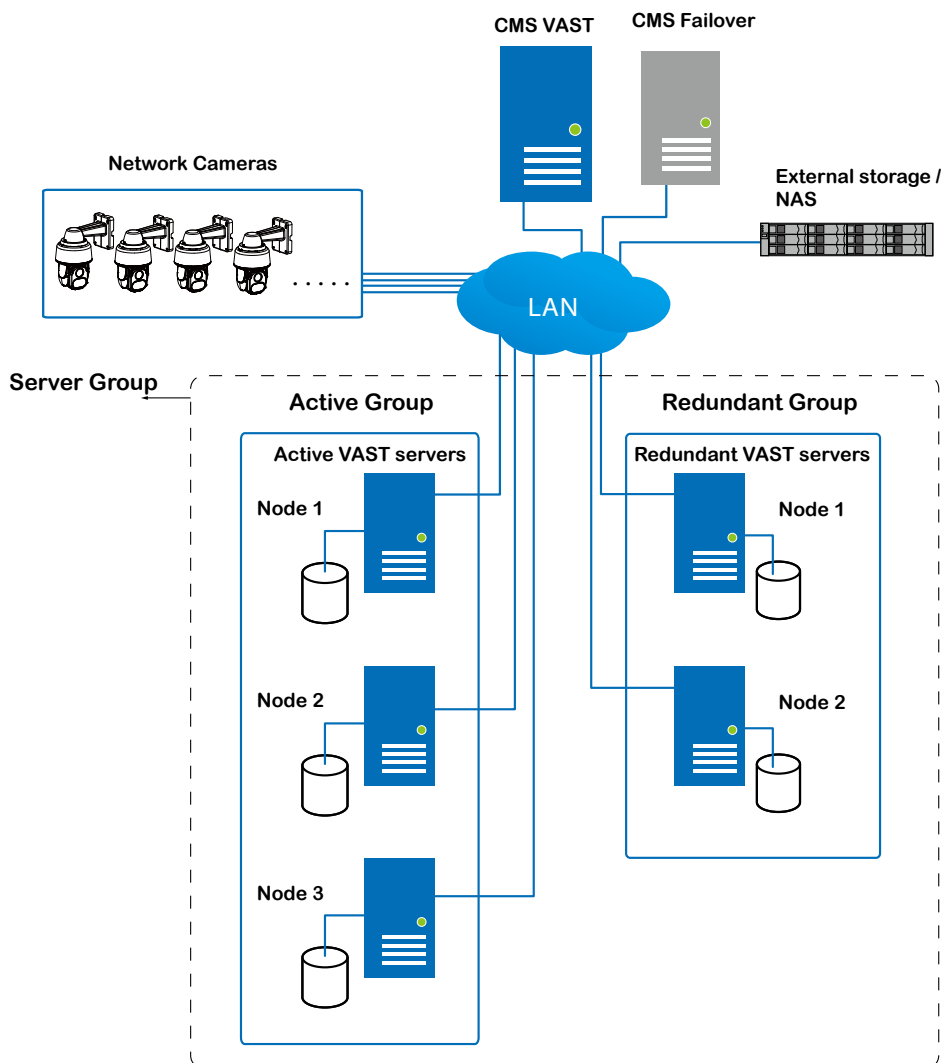

Below are the definitions of server roles:

1. **CMS VAST server:** The main access portal for the configuration.

1-1.	CMS server is where the Failover configuration takes place.
1-2.	CMS continuously polls to check the hearbeats to monitor the statuses of all Active and Redundant servers.
1-3.	CMS regularly backs up the configurations on Active servers.
1-4.	CMS assigns redundant server(s) to the takeover of a failed Active server.
1-5.	In a Redundant server configuration, the CMS is supposed to be up and running at all time. If the CMS server fails, the server failover and failback operation will not take place. It is therefore preferable to configure a CMS redundant server, and install the CMS server at a high up-time environment, such as on a VMWare configuration.

2. **CMS Redundant server:** This is a failover server that serves as the backup for the CMS server.

Note that this redundant server is configured in **Settings > Devices > Sites**. Click **Add Sites**, and select "**Add as a redundant server for**" "**CMS**." See next section for the configuration procedure.

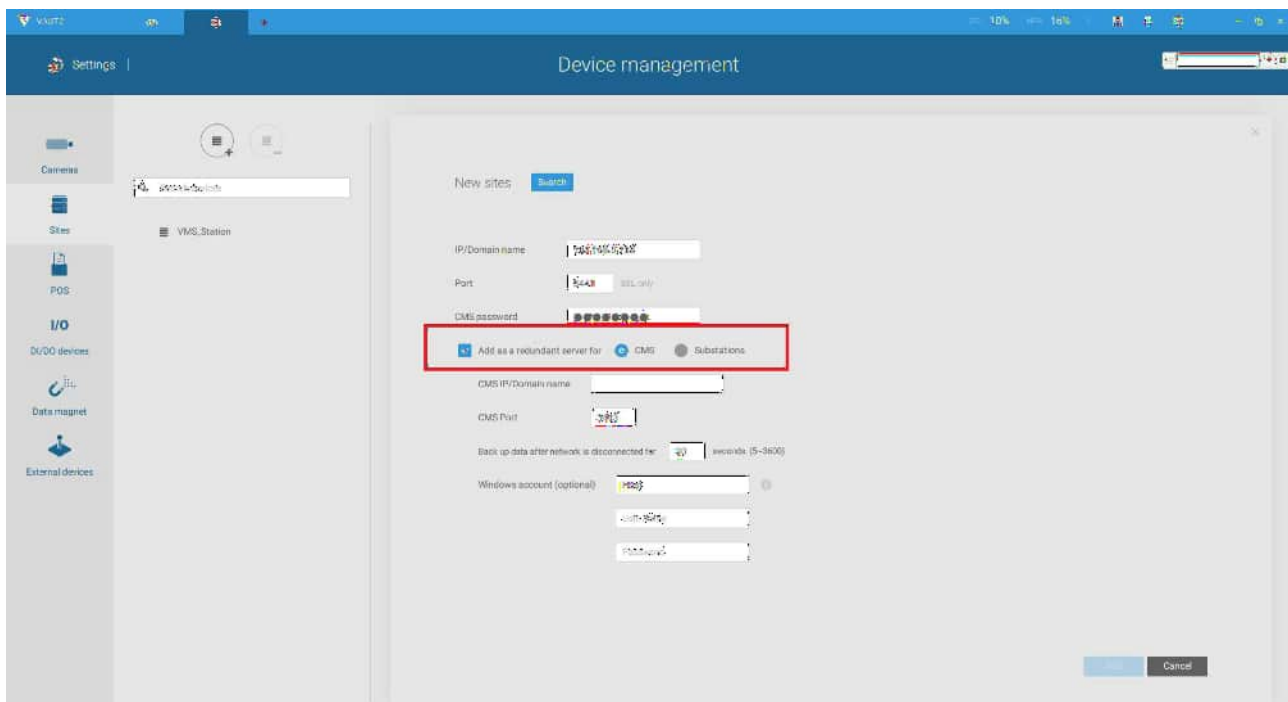

3. **Active servers:** Active VAST servers are the work horses that perform recording and monitoring tasks.

4. **Redundant servers:** The Redundant servers are actually active-standbys. They participate to continue video recording in the event of active server failures. It is recommended for the Redundant servers to have an equivalent or higher processing power than the Active servers. The same applies to the size of storage volumes and the disk drives' write performance.

Note that you cannot configure a Redundant server by opening a local console.

The conditions during the failover process are illustrated below:

Multiple Active and Redundant groups can be created.

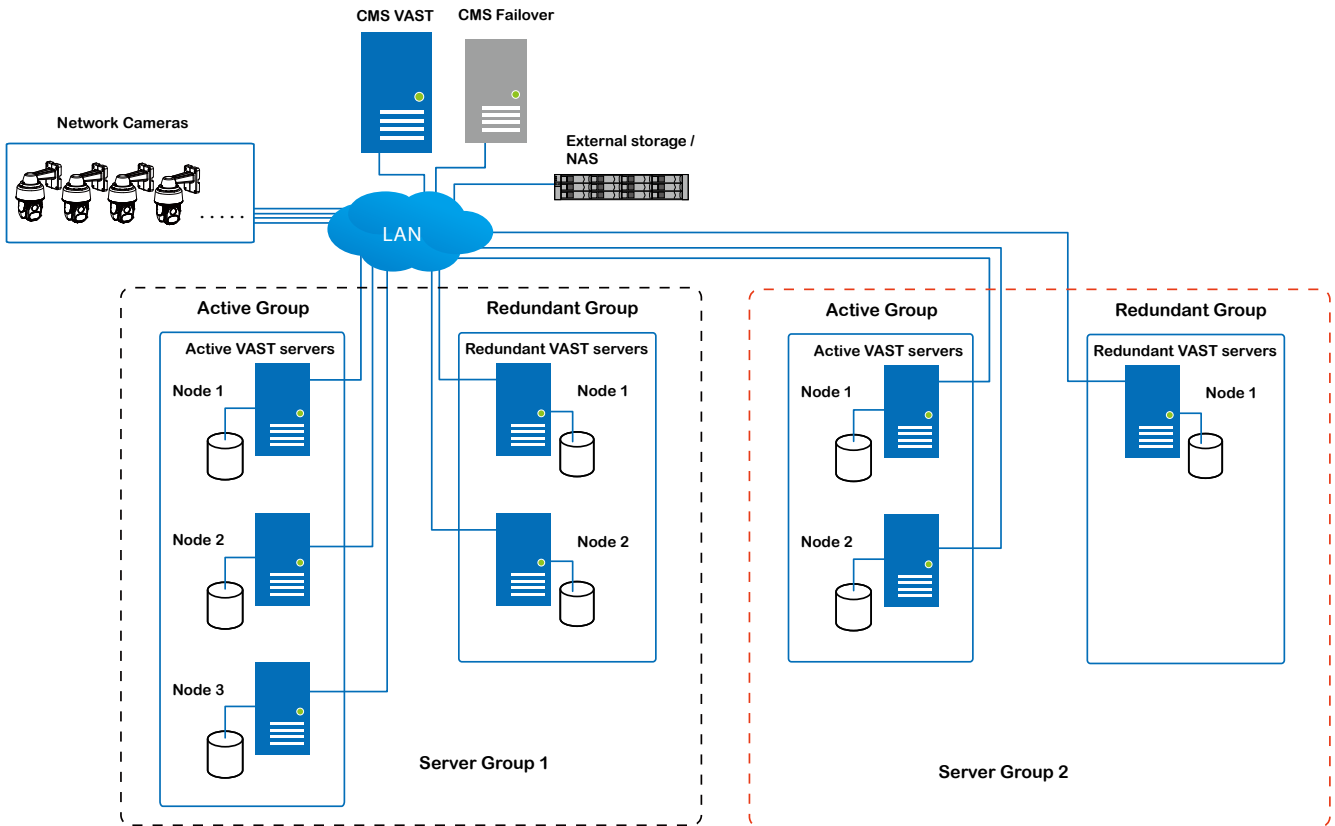

Each Redundant server can serve as the backup for ONE Active server. Depending on the number of the Active and Redundant servers, if the number of failed servers exceeds the number of Redundant servers, the failover will be abandoned. For example, if 2 Active servers failed, and there is only 1 Redundant server available, the second Active server that failed will be abandoned.

In the event of a server failover, a VAST2 server in the Redundant group takes over the recording task. Note that depending on the network environment, the takeover can take up to 5 minutes.

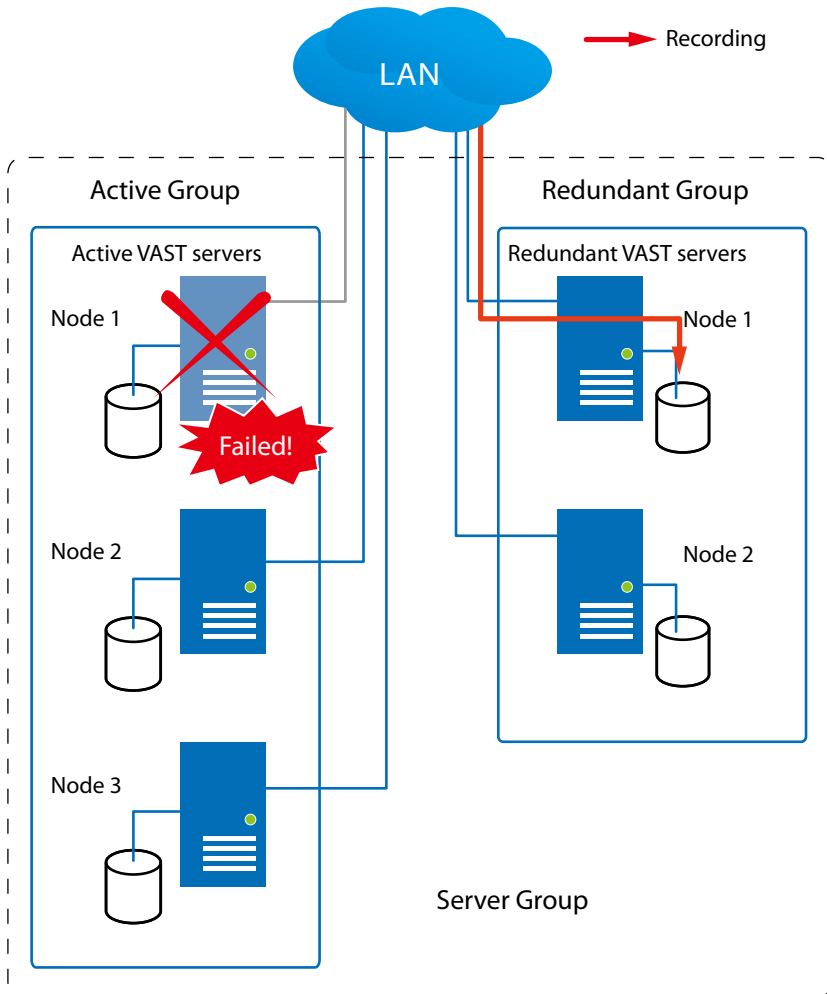

Once the server in the Active group is restored to normal operation, and a CMS server requests for the recordings and data occurred during the time the active server failed, the requests will be fulfilled by a shared volume on the redundant server. Due to the concerns with network bandwidth and processing power, the restored active server does not synchronize its recording pool with that on the redundant server after the failover and failback process.

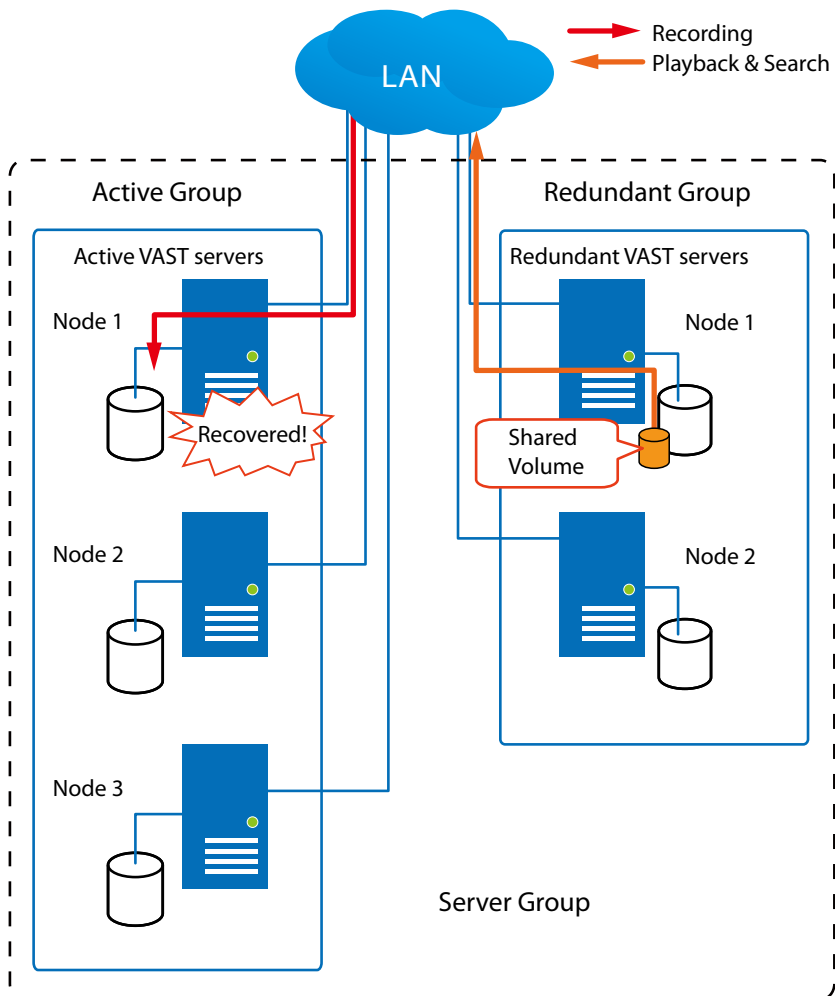

In terms of network failure, the VAST2 configuration supports Seamless Recording. For cameras equipped with an SD card, video is recorded to the SD cards in the event of network failure. Of course, the cameras must have a backup power source, such as a DC 12V input. In cases such as the only PoE switch or PoE mid-span fails, power is lost.

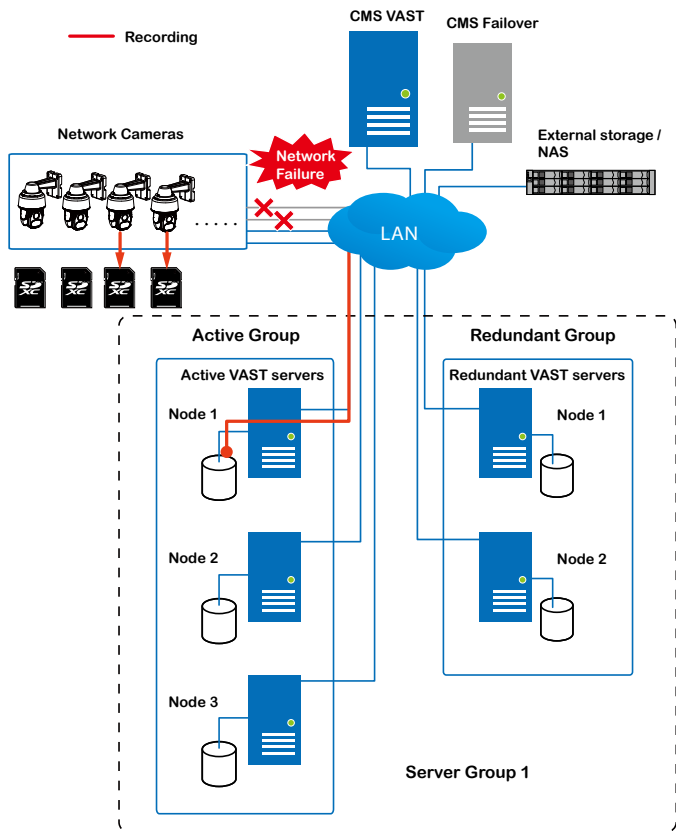

Once the network connection is restored, the VAST2 servers resume the recording task and also retrieve video segments from the SD cards. The video segments recorded during the network failure will be stitched up with those occurred before and after the network failure. The retrieval speed varies depending on the available network bandwidth and CPU resources.

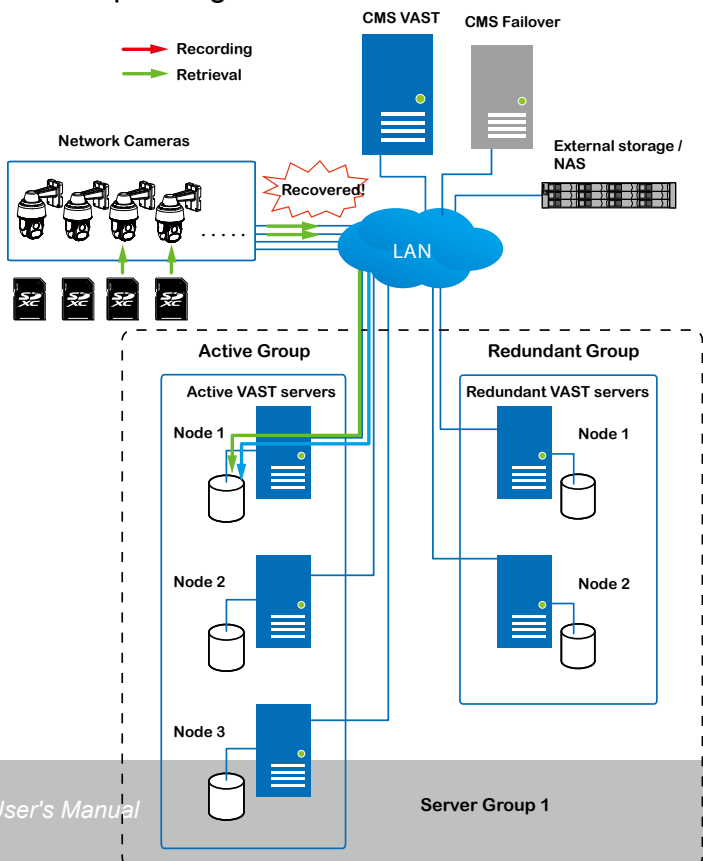

To enable Seamless recording, find the associated option in **Settings > Recording options**, and select the Seamless recording checkboxes. Camera models that support the Seamless recording option will have it listed.

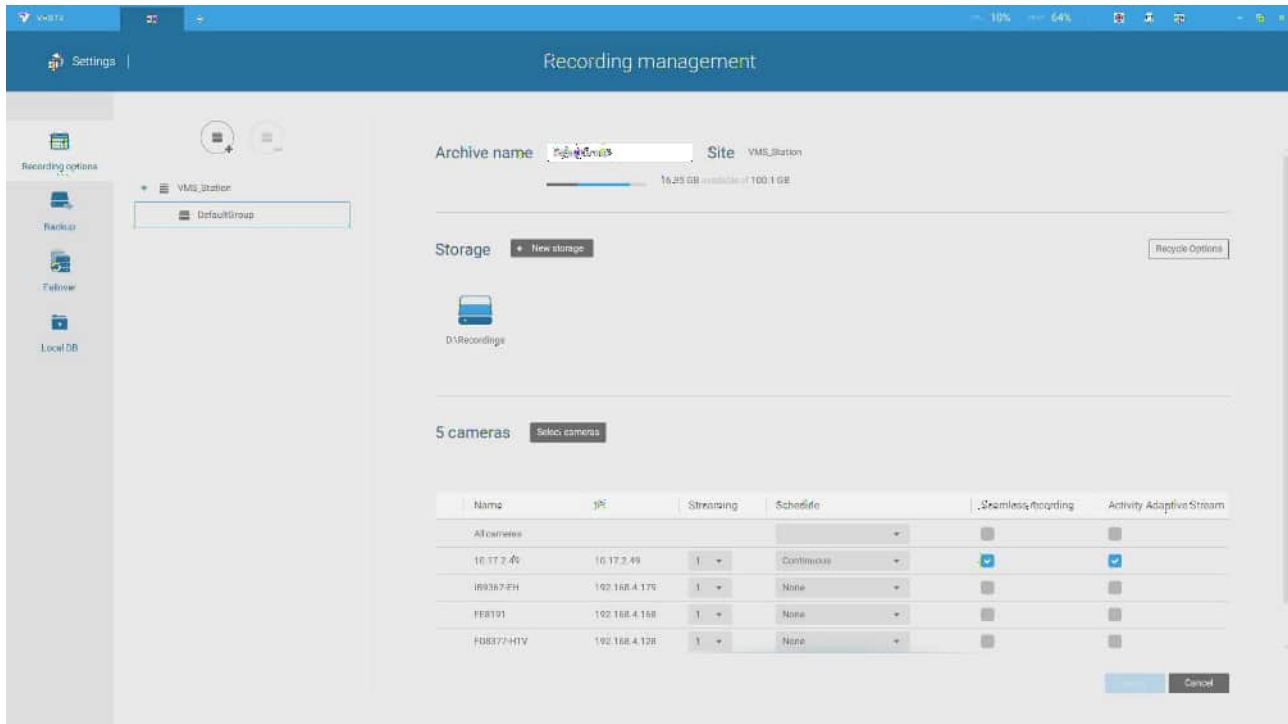

Failover Configuration Process

Before Failover configuration, you need to add other servers to your Failover configuration. Below is a screen from the Sites management window.

- If you are adding a Redundant server, select the "**Add as a redundant server**" checkbox, for either a **CMS** server or VAST **Substations**.
- If you are adding a server without selecting this checkbox, it will be considered as an **Active** server.
- When adding a Redundant server, you can provide a Windows account 802.1x domain user name and password. A Redundant server requires this because a full access to the recorded data is required during the failover and failback process.

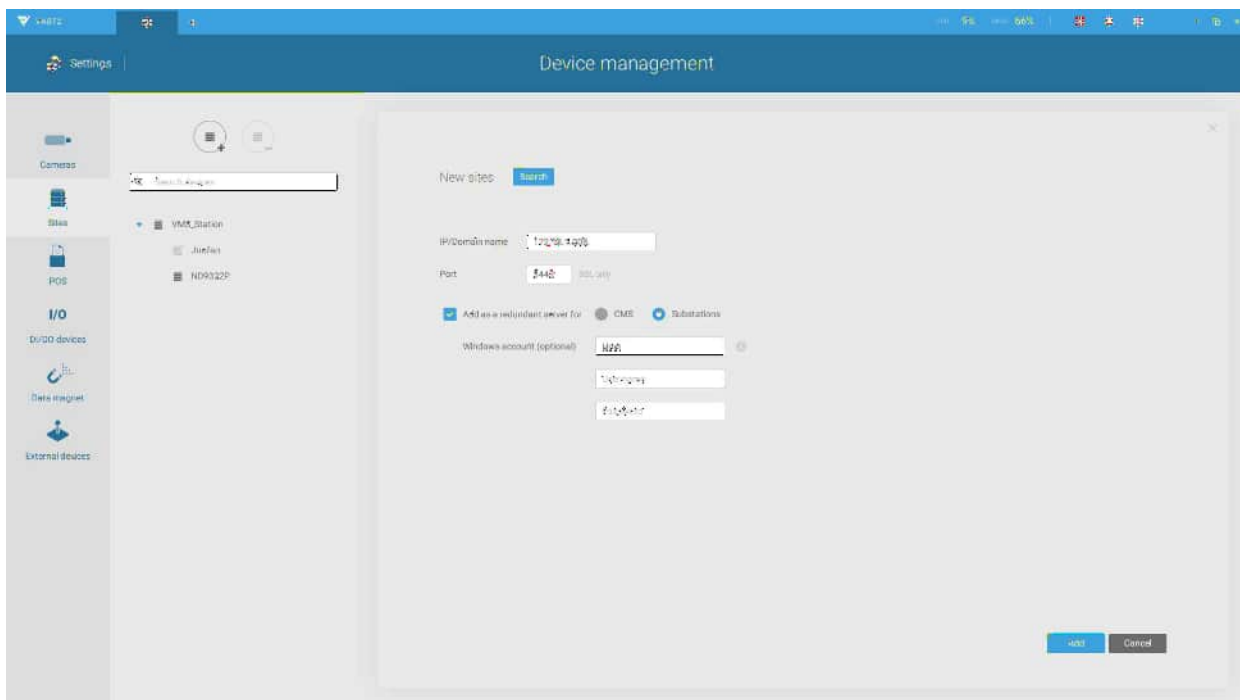

When the **"Add as a redundant server"** checkbox is selected, enter the name of your Windows domain and the user credentials for a full access to the Redundant server.

The screenshot shows the 'Site management' interface. Under the 'New sites' section, there is a 'Search' button. Below it are input fields for 'IP/Domain name', 'Port' (set to 3443), and 'CMS password'. There are three radio buttons: 'Add as a redundant server for' (checked), 'CMS', and 'Substations'. Below these are three input fields for 'Windows account (optional)': 'Host', 'User name', and 'Password'. At the bottom right are 'Add' and 'Cancel' buttons.

Note that it is a must for the Redundant server to be installed differently by selecting a **"Redundant server"** checkbox during the installation process.

The screenshot shows the 'VIVOTEK VAST2 Installation' window. The title bar says 'VIVOTEK VAST2 Installation'. The main content area is titled 'Select a server'. There are four radio button options: 'Standard server', 'Free version: 32 channels of VIVOTEK cameras only', 'Trial version: 256 channels of camera licenses and advanced licenses for 60 days', and 'Redundant server'. The 'Redundant server' option is circled in red. At the bottom are three buttons: '< Back', 'Next >', and 'Cancel'.

When a Redundant server is successfully added, the server will be listed under your VMS station.

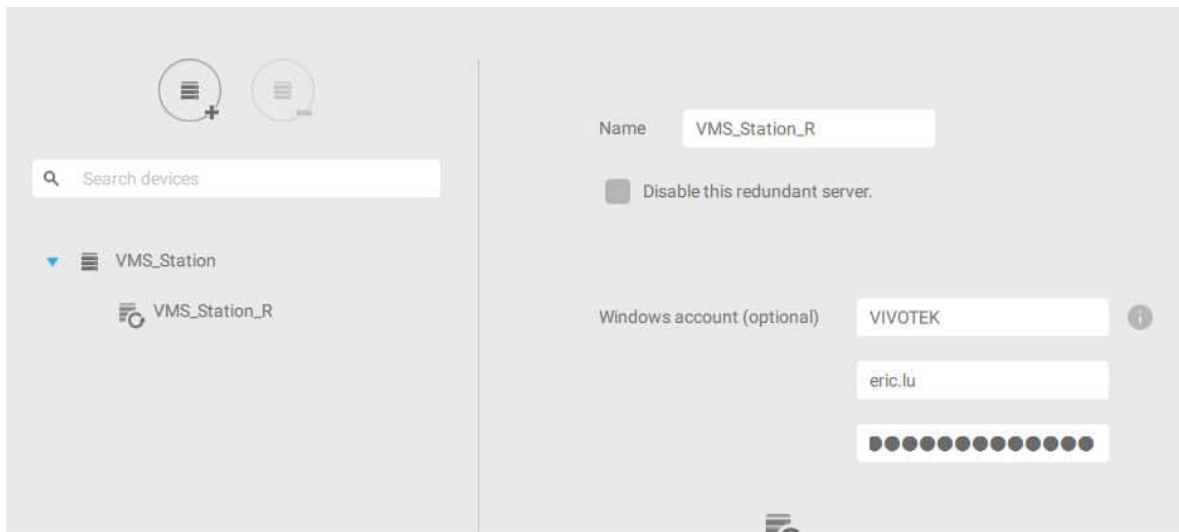

A Redundant server comes with an associated icon, .

An Active server must have a CMS password configured for the hierarchical configuration.

Note that on the **Active servers**, you should configure them as the subordinates to your CMS VAST server. On a web console to these servers, open the Site management page, and select "**Allow CMS to access this site.**" Create a common password for the CMS hierarchy.

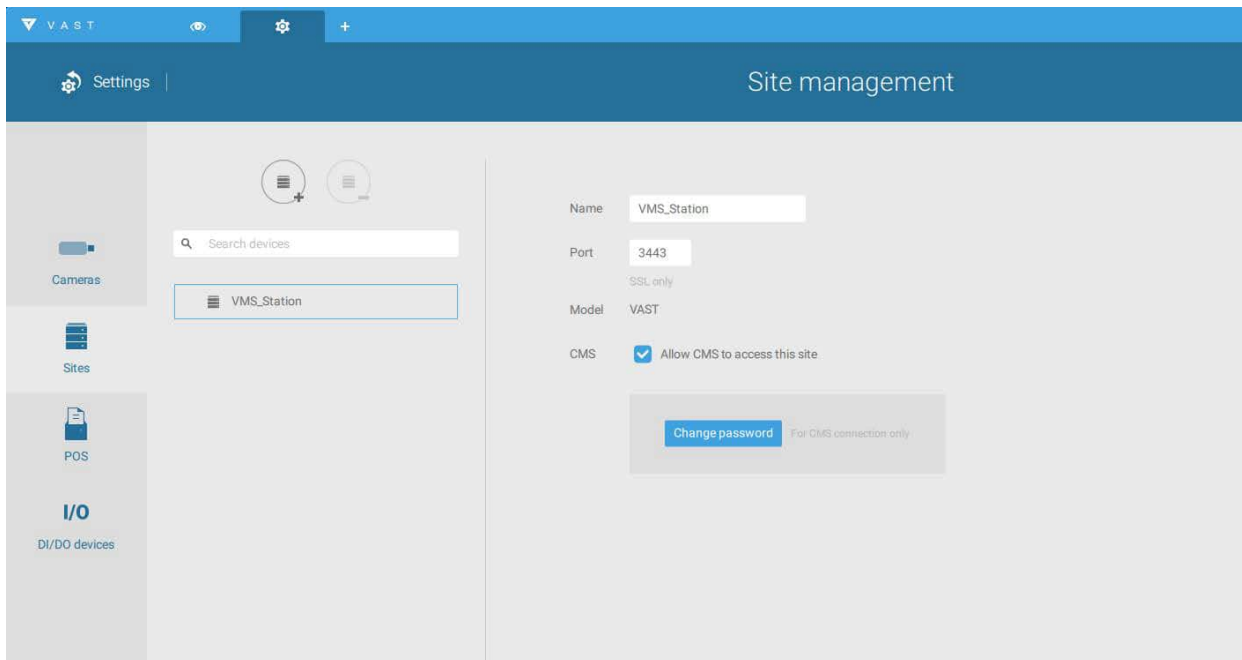

Two agents will be running on the Active and Redundant servers, "stunnel" and "VMSWebServer." Make sure they are not blocked out by your firewall. These agents can be found in the default folders below:

C:\Program Files (x86)\VIVOTEK Inc\sTunnel\stunnel.exe

C:\Program Files (x86)\VIVOTEK Inc\FAST\Server\VMSWebServer.exe

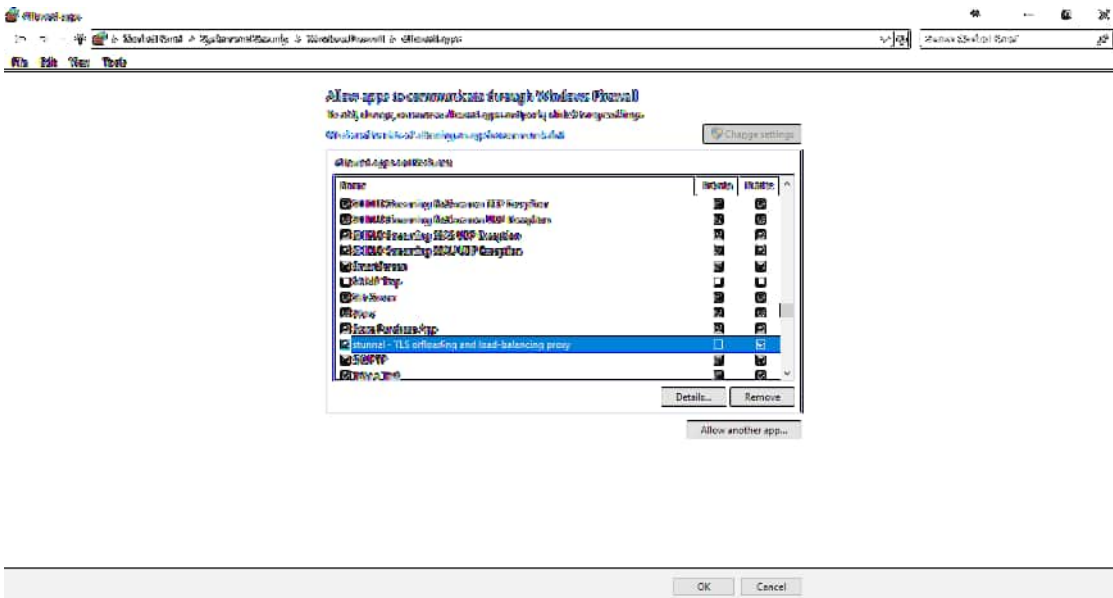

Click on the Add  button to create a Redundant server group. The Active and Redundant servers you enlisted on the Sites page should all be listed below. Select the members of the Redundant group, and click Add to complete.

The default for the network disconnection timeout is 30 seconds. It is not recommended to configure a very short timeout, e.g., 5 seconds, because if doing so, a temporary network disorder can make servers consider the Active server(s) have failed.

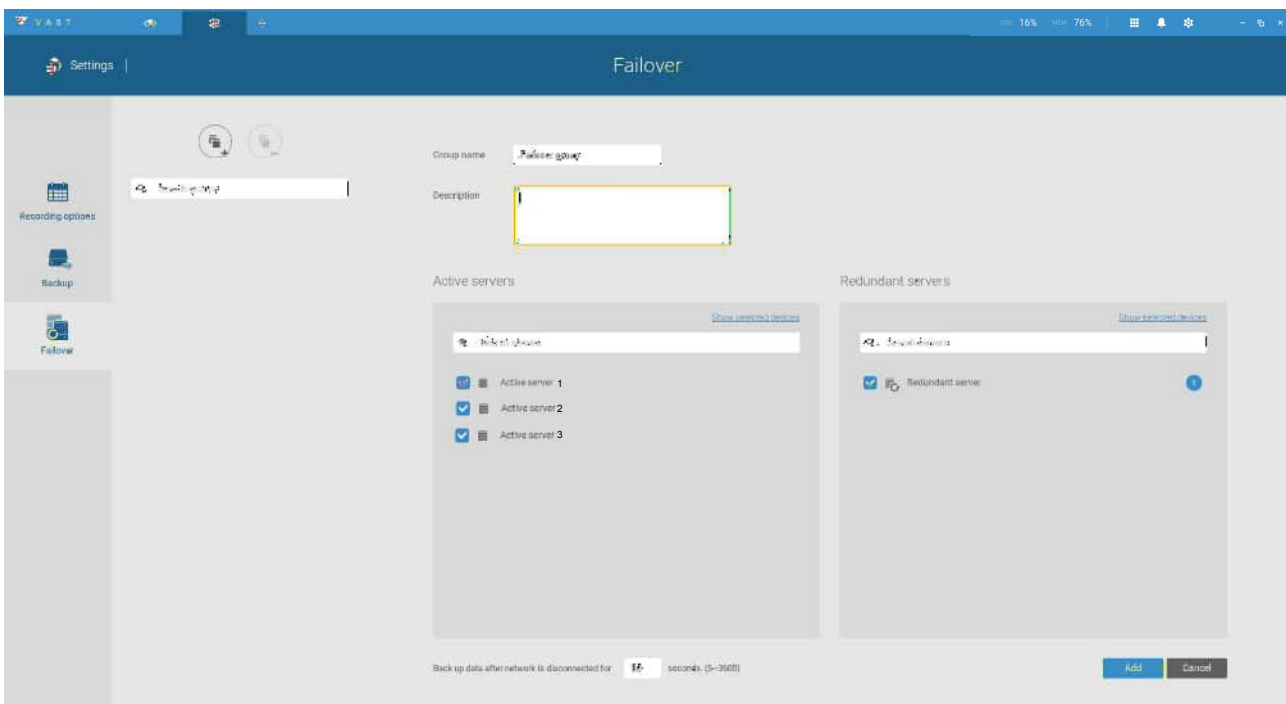

3-3. VCA (Video Content Analysis)

The VCA Report utility is started from the tool bar on top, . The VCA Report utility provides comprehensive graphs and line charts for quick access to the data collected through VIVOTEK's People Counting modules, such as the SC8131 stereo camera. Statistical results is refreshed by hour or minutes, and you can compare the results acquired through different time periods or among different surveillance areas. These data help figuring the customer flow in retails so that shop owners can optimize the arrangement of store layout, or mange queues more efficiently.

Note that the configuration of detection methods in People Counting still occur on a web console to individual cameras. It is not configurable through the VAST LiveClient.

Prerequisites:

The prerequisites for using the VCA Report are:

1. The monitoring server running the VCA Report utility must be up and running during the time the counting VCA is taking place. If you power off the server, the counting metadata generated during the server down time will not be available for analysis.

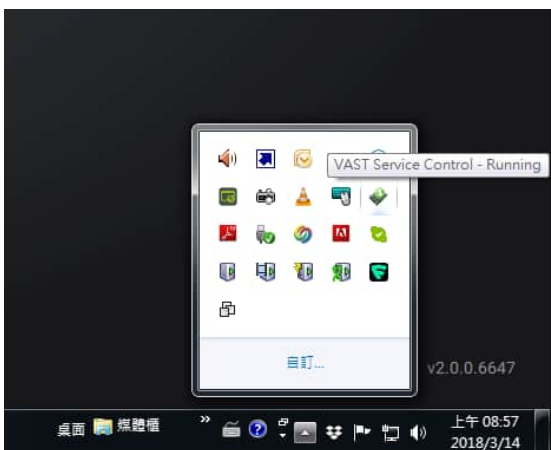

The VAST2 server instance runs in the background. The VAST2 management console needs not be started during the VCA Report data collection process.



2. Cameras running the VCA utilities have been configured and added into the VAST deployment. The instances of available VCA rules will be listed in the **Area** panel.

3. The life expectancy of VCA records is 5 years.
4. Currently the utility supports Windows XP, 7, 8, and 10.
5. The latest revision VAST supports Seamless Recording, in order to retrieve collected data and recording during Ethernet disconnection. Provided that an SD card is installed on the VCA-enabled cameras, the VAST station gradually retrieves data from the SD card after the connection is restored.

To start VCA report:

1. Click on VCA report  button on the tool bar.
2. Select People Counting.
3. Click on the Add area  button.

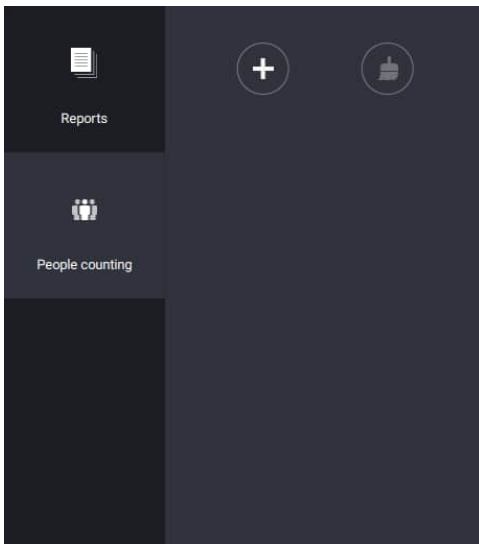

4. Select a camera that is VCA-enabled, and then click the Create button.

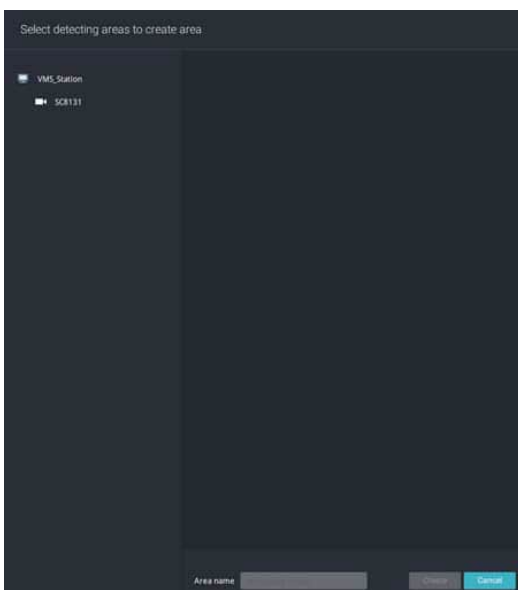

- The pre-configured counting rules (areas) will automatically display. Select a counting rule and enter a name for the area. When done, click the Create button.

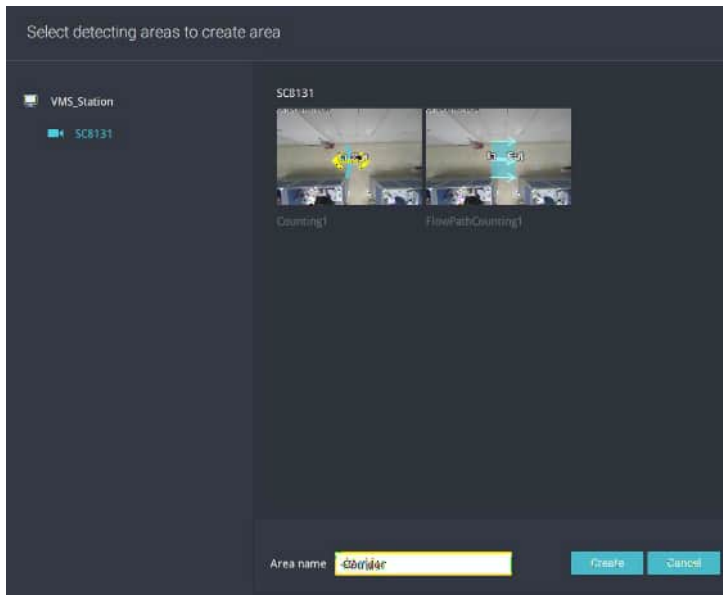

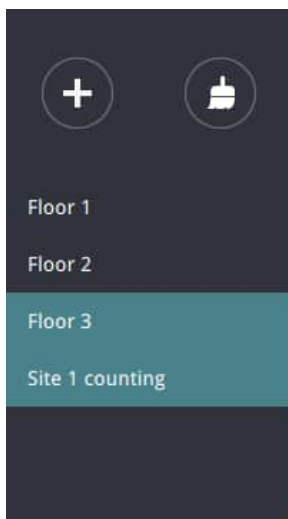

If only one camera is selected, its name will apply as the Area name. If not, enter a name for the area.

- Click to select one or multiple areas. Those selected will be highlighted in a different color.



7. Select Date & Time

7-1. By default, the time displayed on the calendar is the current system time on the client computer running the utility. Select from the **Date** selector  on top.

7-2. Select a date or span of time from the calendar or use the **Time**  selector to select a span of time.

- > Single-click to select a date or click and drag to select multiple dates.
- > You can select a month or a year using a single click. If you select a month, the timeline unit will be days within the month. If you select a year, the timeline units will be the months in a year.
- > In the **Month** or **Year** panel, single click to select the entire month or an entire year. Double-click to select sub-units, e.g., days within a month. If you double-click on a Month panel, you will enter the Day panel.

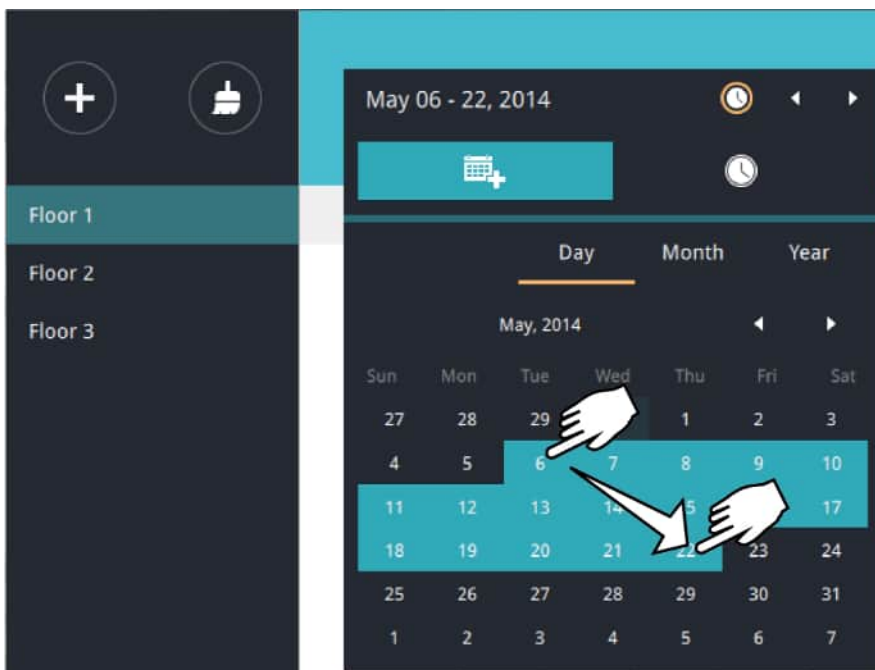

You can select a different month in the **Month** or **Year** panels. The **Calendar** panel disappears if left unattended for 2 seconds.

On a **Month** panel, double-click to select a month, and the **Day** panel for that particular month will display.

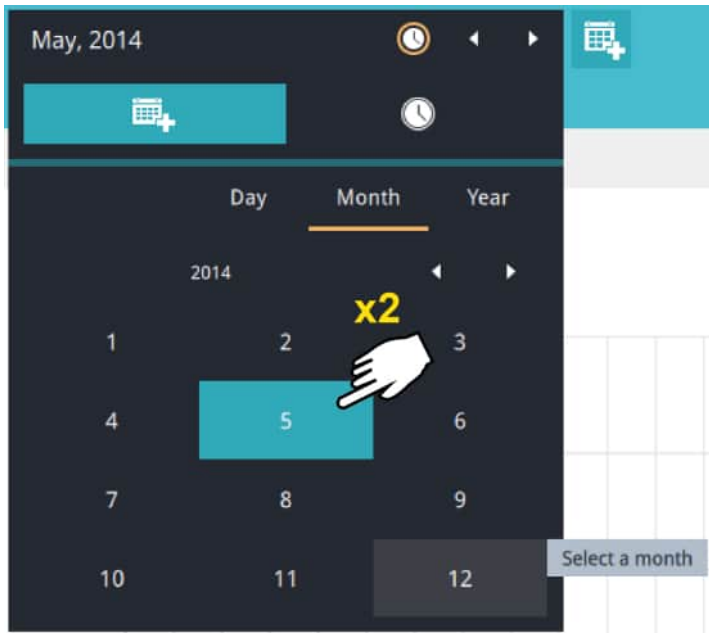

Note the following when making the configuration:

- When a date is selected, the Date and Time panel will not automatically close, and the configuration changes will not take effect until it is closed. You can click on the outside of the panel to leave the panel.
- You can select multiple days to form a span of time. Select one date with a single click and select multiple dates by dragging your cursor across the screen to a preferred end date.
- To select a year, click to open the **Year** panel. Single click to select a year. Multiple years can be selected using the click and drag method.

7-3. Select the hours to be included in the statistical poll using multiple clicks on the chart.

Single-click to select an hour or click and drag to select multiple hours.



Note that you can only compare the counting results from two spans of time if you select only one Area. If you selected multiple Areas, you can not compare the results from multiple time spans.

7-4. Click outside the Calendar panel. The statistical results will display. The default display is the bar chart. Below is a sample screen showing the results polled from 3 areas. Up to 8 areas can be selected in one view.

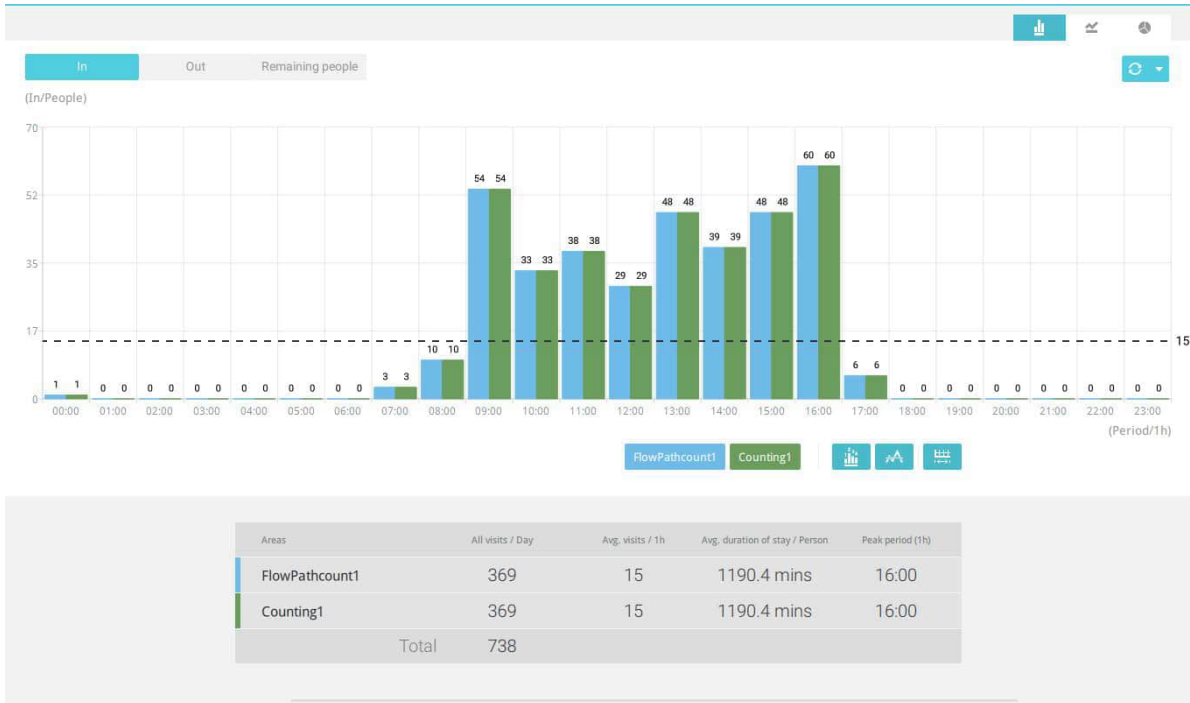



Select different display modes using the **Bar** , **Line** , or **Pie**  chart buttons.



Note that the timeline units can vary depending on the span of time you selected on the Calendar panel. If a date was selected, hourly data will display in chart. If a year was selected, monthly data will display in chart.

Use the following functional buttons to change the display parameters

Show data on chart  : Displays the collected numbers on chart.

Average  : Displays the average number per time span unit (e.g., per hour). If the interval is changed to 30 mins, the average number will be halved comparing to the number acquired by every hour.

Report Interval  : Configure the intervals for polling data from the camera. The default for displaying results is by every hour. If you enter 30 minutes as the display interval, all data will be listed on the basis of the 30 minutes time span. The configurable range is 1 to 1440 mins.

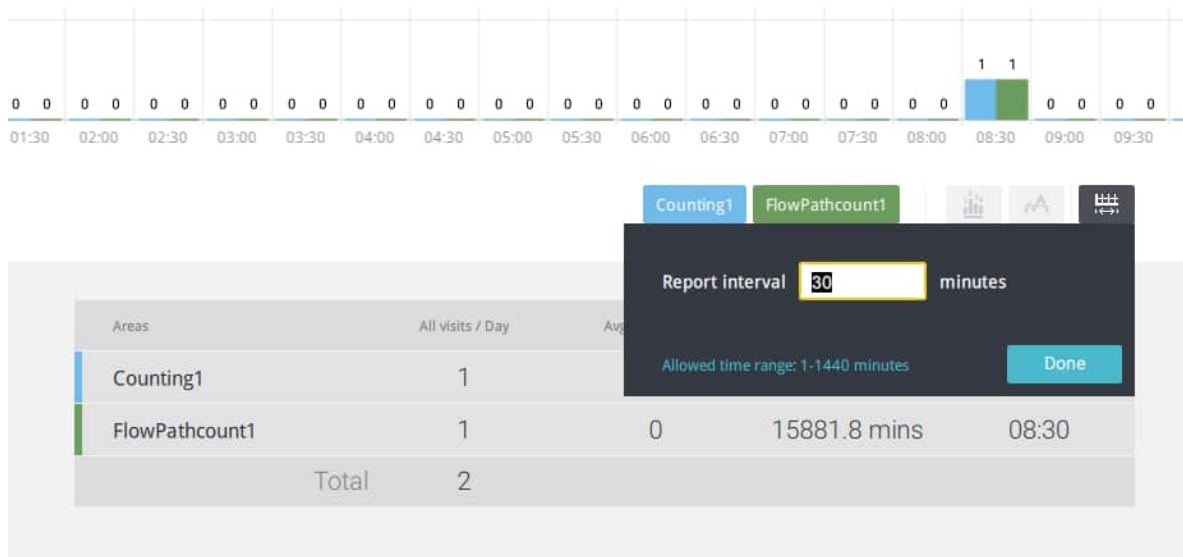

You can use the update menu on the side of the Refresh button to determine an automatic update schedule. You can let the statistic chart update itself by a regular interval.

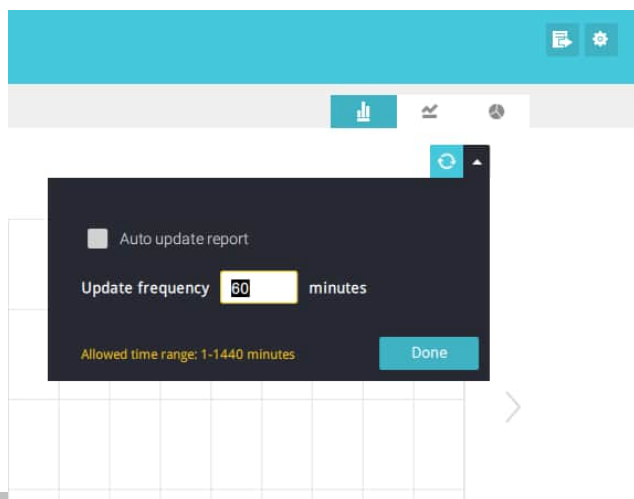

If you selected only one area, you can use the Shift key to select multiple areas (or two spans of time). You can select multiple dates in the Calendar panel.

Use the **Refresh** button  to poll the latest data from camera.



Use the time selector on the **View Report from** pane to select the start time of your statistics view window. Data collected before that time will not be displayed.

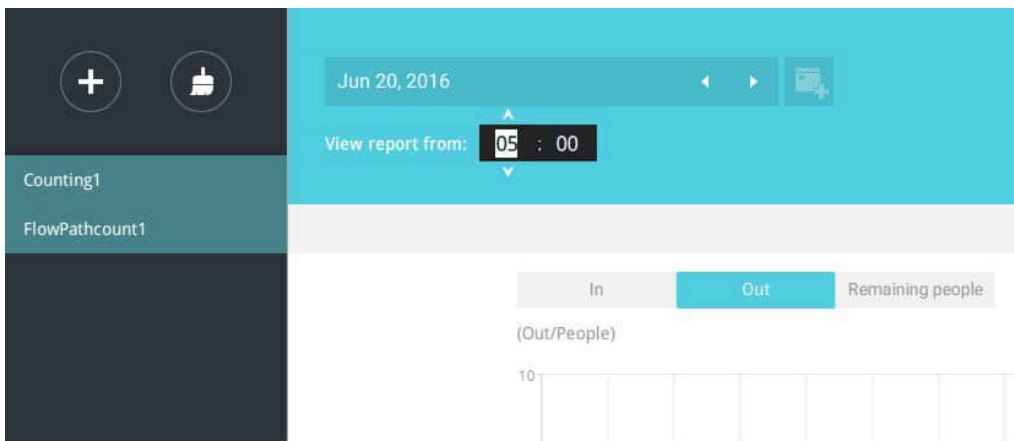

A number is displayed when you mouse over an area on the chart. Move your cursor to an area on chart, and the number is displayed.

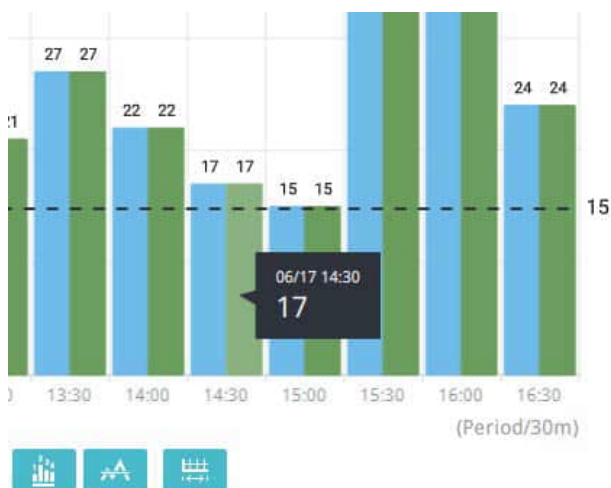

Data on a time line will be generated. To close the window, use the close button on the second date information. Equivalent spans of time can also be used for comparison. For example, you can compare the data in a span of 4 days against another span of 4 days.

Note that the Compare function only applies when you select to display only one area on screen.

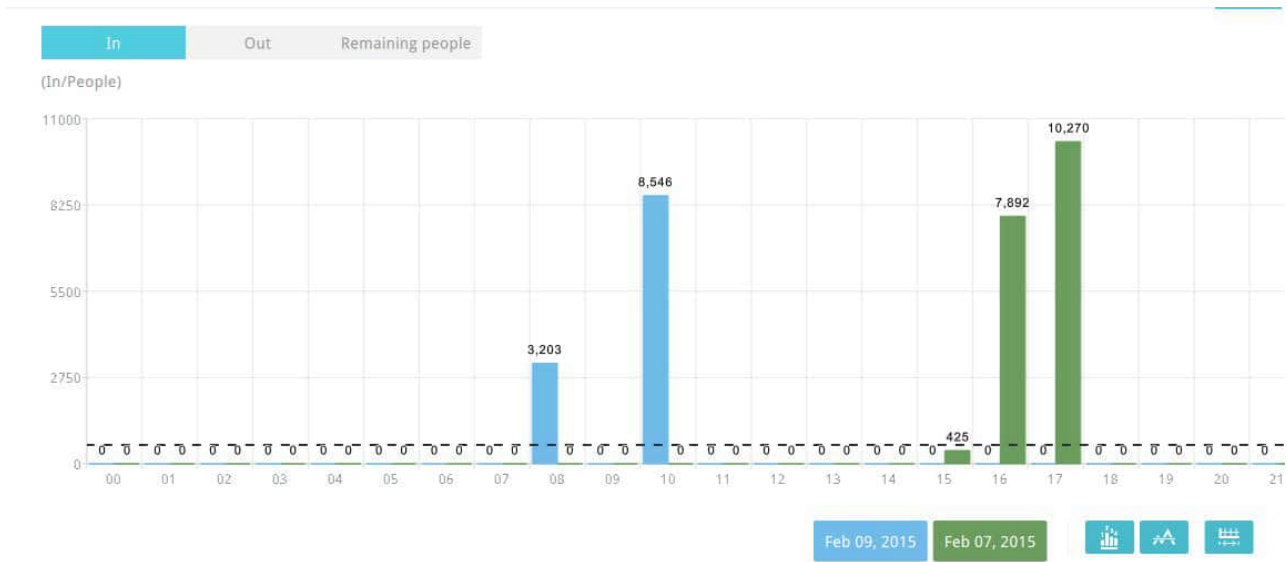

In a comparison result displayed in a line chart, mouse over to the peak value to display the percentage of an increase or decrease rate.



See below for the functions of buttons on screen.

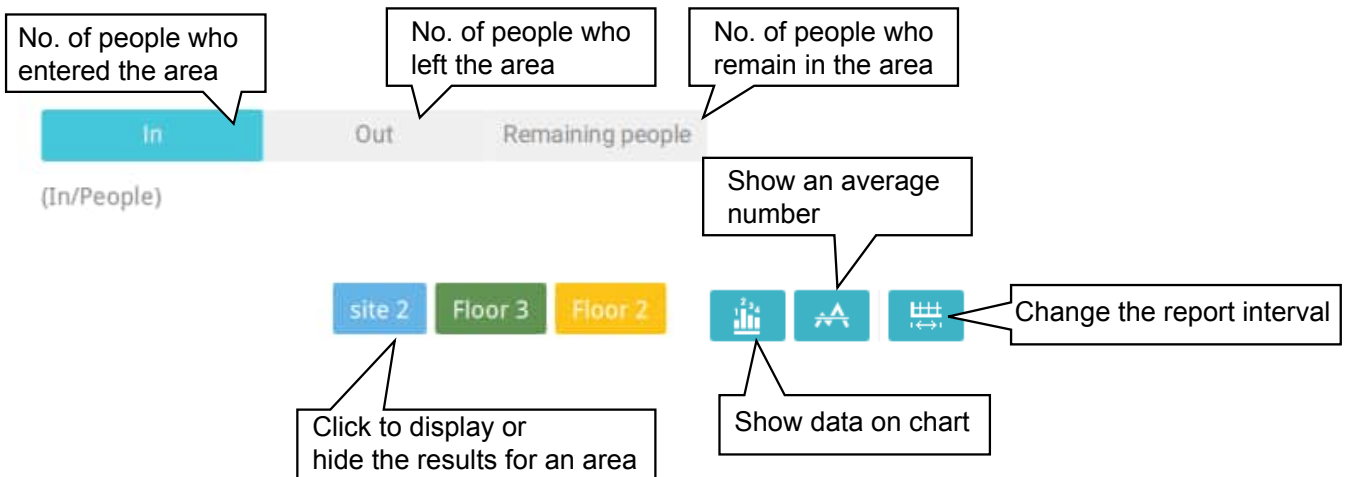

In addition to the charts, a summary of displayed data will be listed below showing the areas involved, visits/Day or Month, Average visits / Hours / Days, Average duration of stay / person, and the Peak hour.

Areas	All visits / 4 days	Avg. visits / Day	Avg. duration of stay / Person	Peak day
Floor 3	490,870	122,718	106.3 mins	12/04
Floor 2	959,482	239,870	105.9 mins	12/02
site 2	3,873,510	968,378	108.0 mins	12/01
Total	5,323,862			

8. When done with displaying the results, you can use the **Export**  button to produce an image file to preserve the current results. Both a spreadsheet and a graphic chart will be produced.

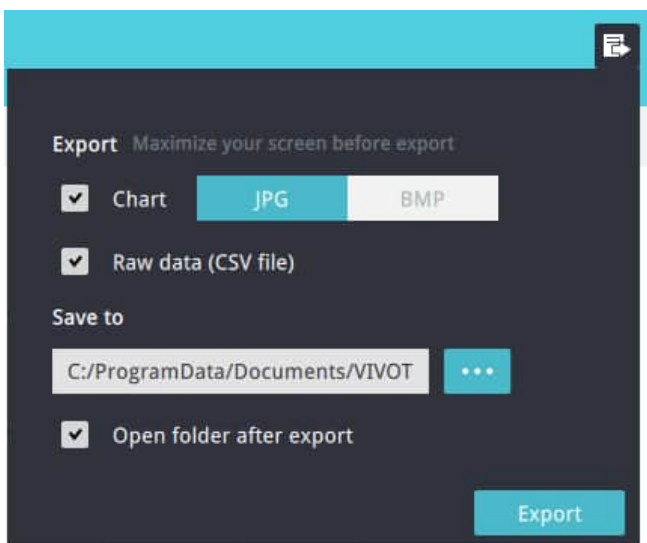

By default, the exported report is placed in:
 C:\ProgramData\Documents\VIVOTEK Inc\
 VAST\Client\VCARreport

9. Click the Reports Subscription button to configure the regular report sent to your Email account or a specific location on the server itself.

Select the following:

1.	Report type: People counting results, or Heatmap (Heatmap does not produce CSV file)
2.	Area: All areas or a preconfigured area.
3.	Subscribe: Enter the sender and recipient Email addresses. You can also configure to send the report to a specific location on the server.
4.	Attachment: Select to attach graph Charts in JPG or PNG, and the CSV data files.
5.	Time frame: Select the time coverage of the report, during which data is collected.
6.	Frequency: Specifies when and how frequently to deliver the reports.

Select the time to deliver your mail notification. Enter valid Email addresses as the sender and receiver addresses and make sure the SMTP mail server configuration has been properly configured on your VAST server. This VCA mail notification utilizes the mail service on VAST for regular notification. You can then receive Email notification every day on your Email account. You can enter up to 5 recipient addresses.

Select the report interval to determine how often you receive an aggregated report.

Add report

Report name

Report type People counting

Area All areas

Subscribe Email

Sender Sender's email

Recipient

Send to server

Attachment Chart

CSV

Time frame Specify time frame for reports

Start time : : ~ : :

Frequency Everyday at : : Next delivery 2018/03/14 00:00:00

Report interval minutes (10-1440)

Weekly at

Monthly at

Note that the notification contents is your current field of view, including a Bar, Line, and Pie chart combined into one image file. The In/Out/Remaining results will be generated into 3 charts. Each Area will generate one CSV file, and each CSV data file will contain In/Out/Remaining/Summary information.

The generated file names will look like this: 20160226_test02_Remain.jpg for charts and 20160226_Summary.csv for CSV files. The Email subject will be "VCA Daily Report - 2016/02/26."

Note that if you manually export a report, the default is sending the data collected until one hour before the manual export. For example, if you generate the report at 14:07, the report will only cover the data collected until 13:59. You may use the Refresh button to manually generate immediate data inputs (those occurred between 14:00 and 14:07).

You may configure to receive regular VCA report as Weekly or Monthly using the associated menus.

Below are the messages with the Email test function.

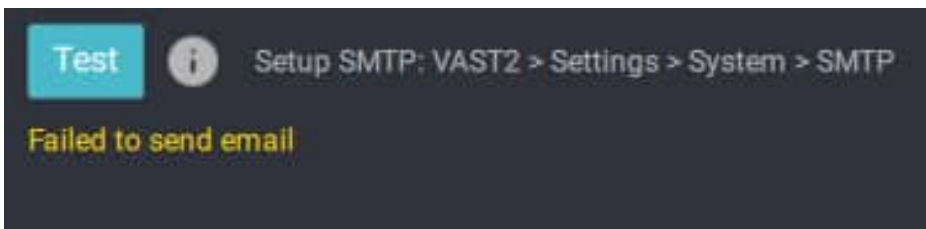

3-4. VAST Software License

To activate the software, refer to the flow chart below:

Scenario	Need	Action
Dongle license users	Need more CHs	<ol style="list-style-type: none"> 1. Help > License > export license. 2. Send license file to VIVOTEK to purchase more dongle license.
New users preferring more than 32 CHs	Need more than 32 CHs.	<ol style="list-style-type: none"> 1. Install the 256 CH trial VAST. 2. Help > License > Generate license update request. 3. Send request file to VIVOTEK to purchase software license.
New users fine with 32 CHs	Fine with less than 32 CHs.	<ol style="list-style-type: none"> 1. Install the 32 CH free VAST.

The VAST software provides 32 free channels. Since revision 1.11, the VAST software is activated using a software license instead of the original hardware dongle.

For users running the previous dongle version, there is no need to upgrade their original license. If they need the license for more channels, They can export their license file, and purchase more dongle licenses.

For users who require more than 32 channels, they can install the 256 channel trial version first, and go to **Settings > System > License** page, and click on the **Export License** button. Send the request back to VIVOTEK to purchase more channel licenses.

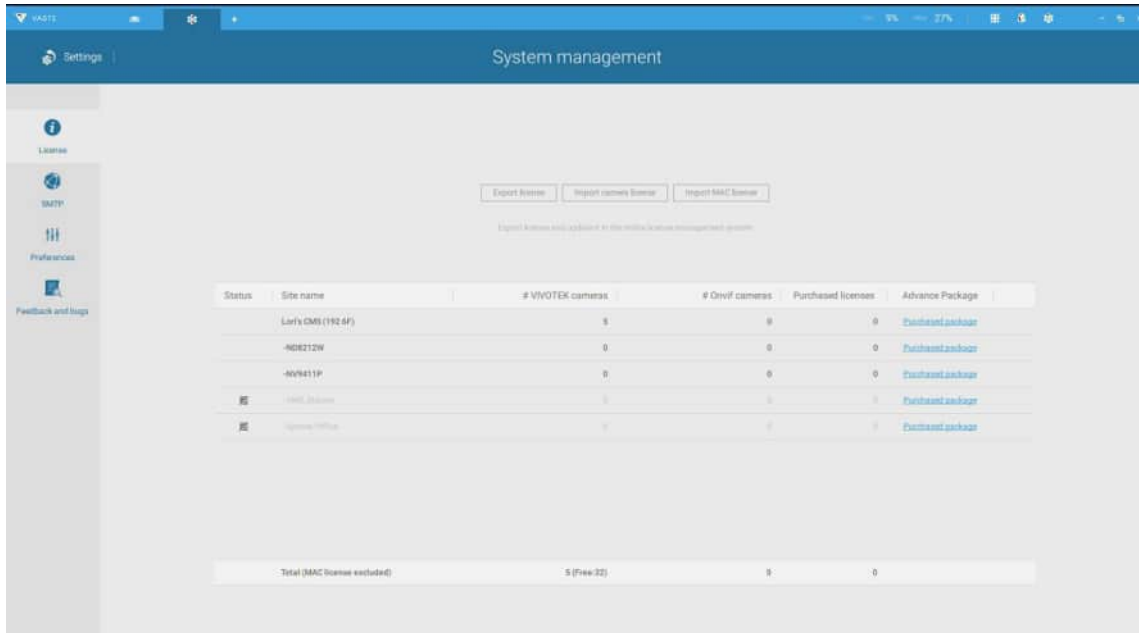

When you purchased and received the official software license, use the **Import License** function to activate the official license.

When importing purchased licenses,

1. System will dispatch licenses to VAST stations according to hardware information,
2. If licenses do not match the VAST stations, you can manually select which license will be dispatched to which station.

Since VAST rev. 2.6, there is an Import MAC license option. You can select a MAC license file and manually deliver the file to one or multiple substations.

Below is a sample procedure for importing the camera licenses:

1. Continue to import the camera licenses.

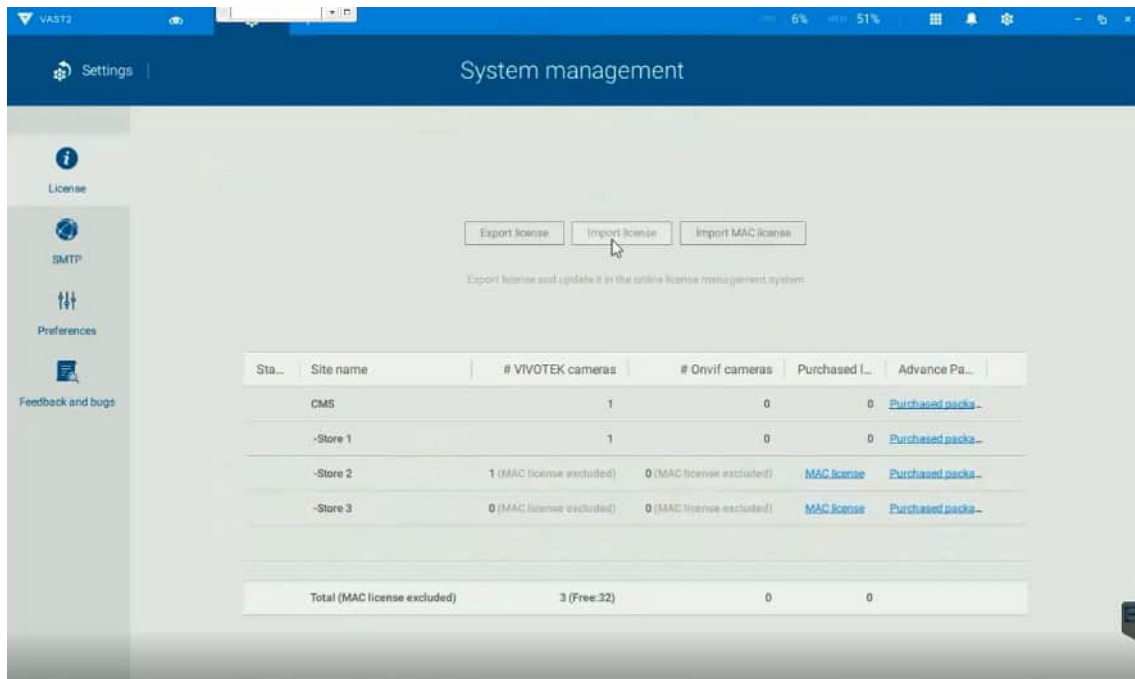

2. When in the Import page, click the Add button to select camera licenses.

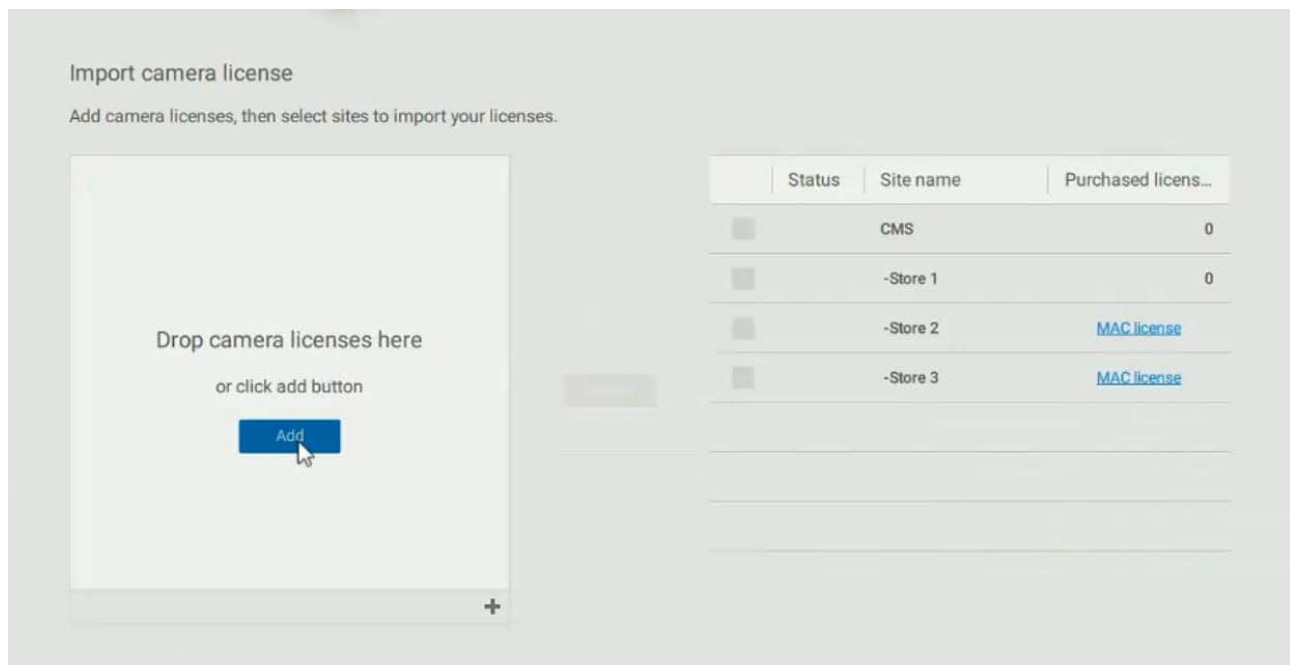

3. Select the target servers, click Import.

Camera licenses are bundled with hardware information. When import camera licenses, the software will automatically match the licenses with corresponding servers.

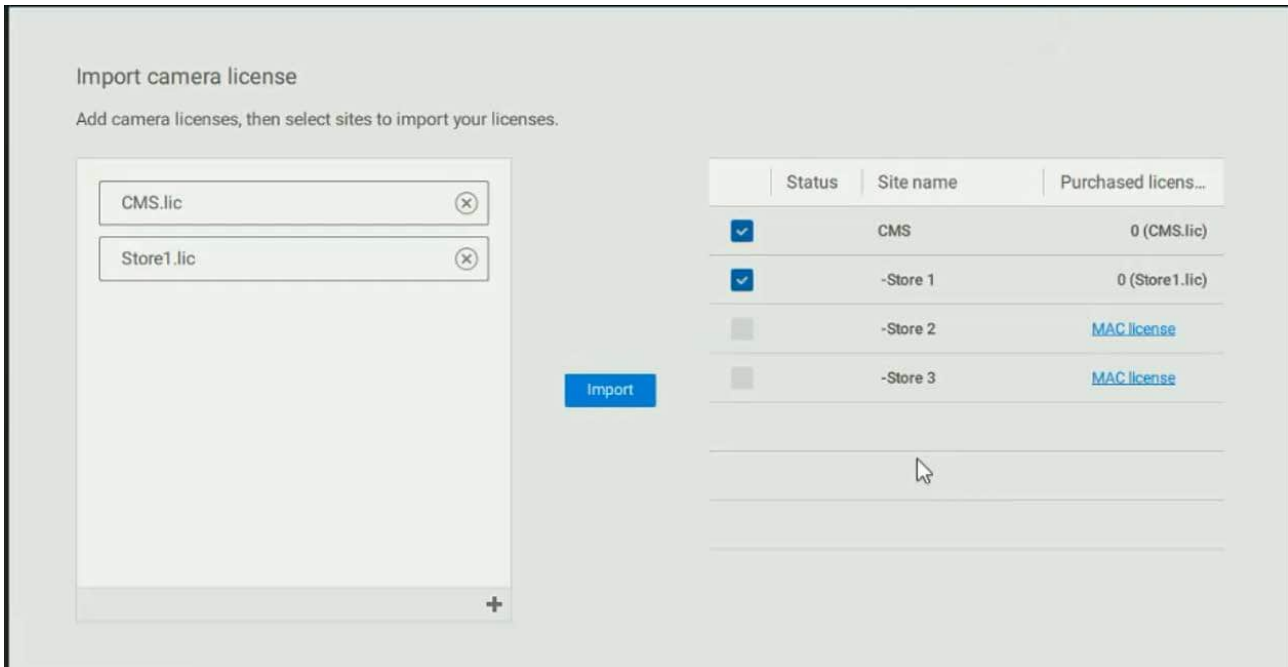

4. When done, a successful import will be indicated.

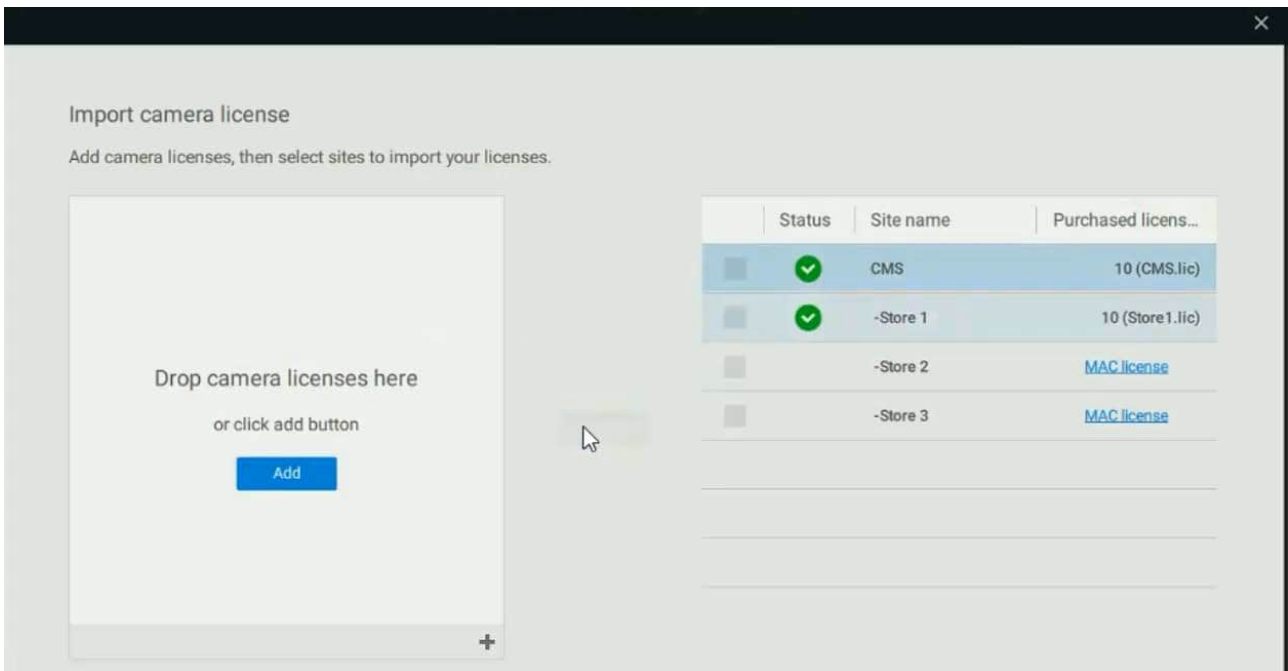

Updating Licenses for VAST on Virtual Machines

NOTE:

1. The VAST server supports the installation on VMWare, Virtual Box, Parallel, and Hyper V.
2. A MAC address authentication mechanism is implemented for VAST running on virtual machines.
3. The license requests have to be generated from the VAST2 installed on a Virtual Machine. If your configuration consists of multiple VAST servers, and one of them is installed on a virtual machine, exporting license information will generate a MAClist file. The MAClist file will be used for the VAST instances running on virtual machines.

This instruction includes:

1. How to Export a license request from VAST2 on a virtual machine.
2. How to acquire the MAC addresses of the inserted or non-inserted cameras?
3. Send us request files & MAC addresses (If you have multiple sites, please remember to designate grouping information, such as which MAC addresses belong to which camera deployments).
4. How to Import MAC licenses to VAST2?
5. How to buy more MAC licenses for future distribution?

1. How to export request from VAST2 on VM?

- 1-1. Install VAST2 server on a Virtual machine (usually VMware workstation - full - 12.1.1), or download VAST2 from VIVOTEK website.
- 1-2. Insert cameras for the VAST station (optional).
Go to virtual machine, Open VAST2 > Settings > Insert cameras (You may already have more than 32 cameras inserted if you are using the trial version).
- 1-3. Go to VAST2 > Settings > License > Export license.

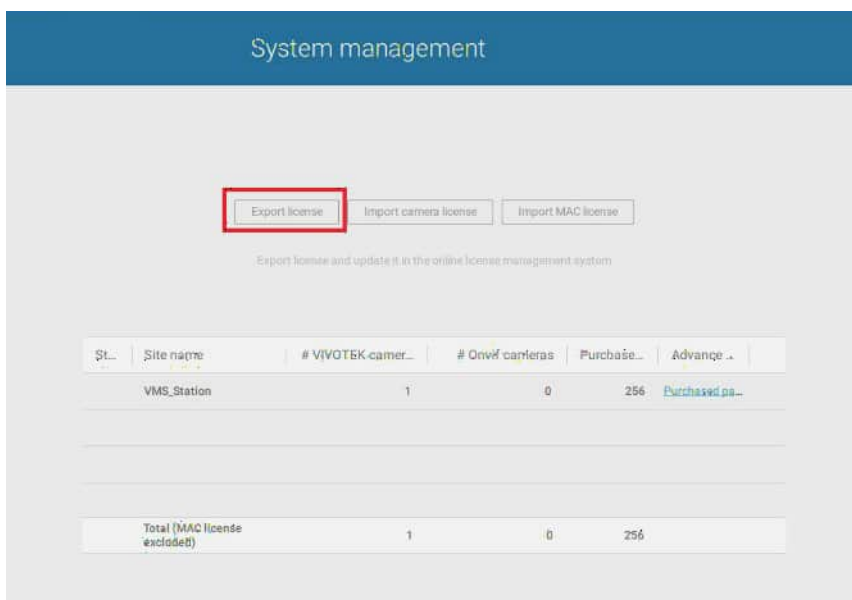
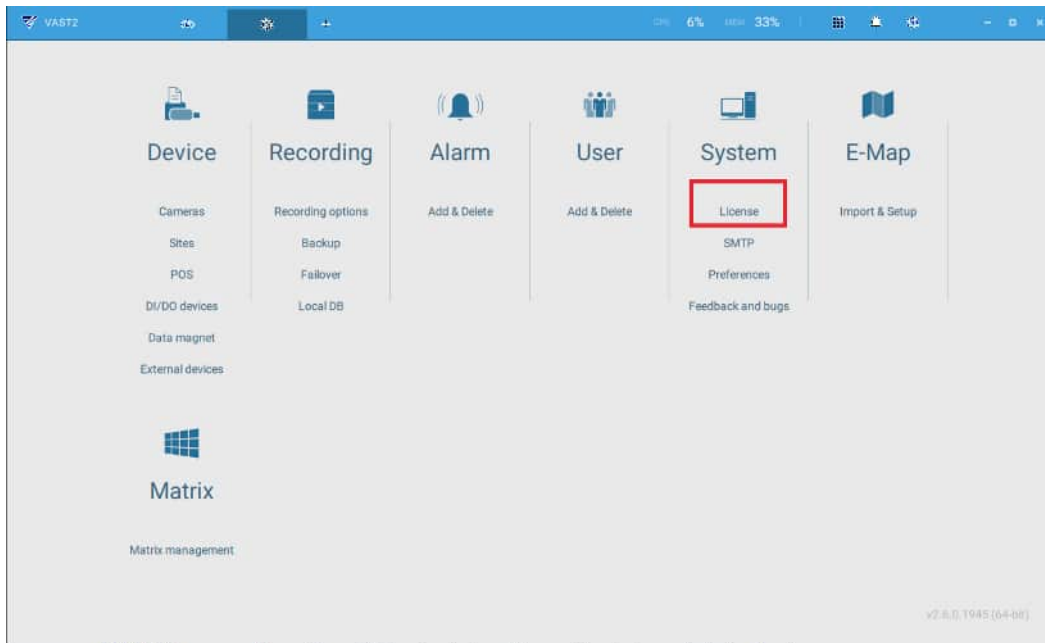

- 1-4. Click the Export license button and select your Windows desktop as the destination folder. A VAST2 license folder will display on the desktop, zip the folder and send the request file back to your sales representative, distributor, or VIVOTEK.

The generated MAC list should look like this.

```

VAST2Generated_MacList.txt - 記事本
檔案(F) 編輯(E) 格式(O) 檢視(V) 說明(H)
CMS
0002D118F6C9
Store 1
0002D118F6C9
Store 2
0002D130D08B
0002D118F6C9
Store 3
0002D13A0741
    
```

You can examine your current license status. Click on Purchased package. The licenses currently in use will appear.

The screenshot shows a web interface for license management. At the top, there are buttons for 'Export license', 'Import camera license', and 'Import MAC license'. A modal window titled 'Purchased package' is open, displaying a table of license usage:

Name	License (used/total)
Google map	8/101
GPS receivers	3/100
TCP message	0/100
PDS	1/100
Fallover	5/101
Data Magnet	0/101

In the background, a table shows the following data:

Status	Site name	Purchased licenses	Advance Package
	Lori's CMS	100	Purchased package
	-Active Server	100	Purchased package

At the bottom of the interface, a summary row shows: Total (MAC license excluded) | 8 (Free:32) | 0 | 200

1-5. Once you acquired the MAC licenses from VIVOTEK, click Import MAC license button. You will enter the import page. Use the Add button and locate your license files.

To use the MAC license import function, both the CMS and its substation servers should both be running VAST revision 2.6 or above.

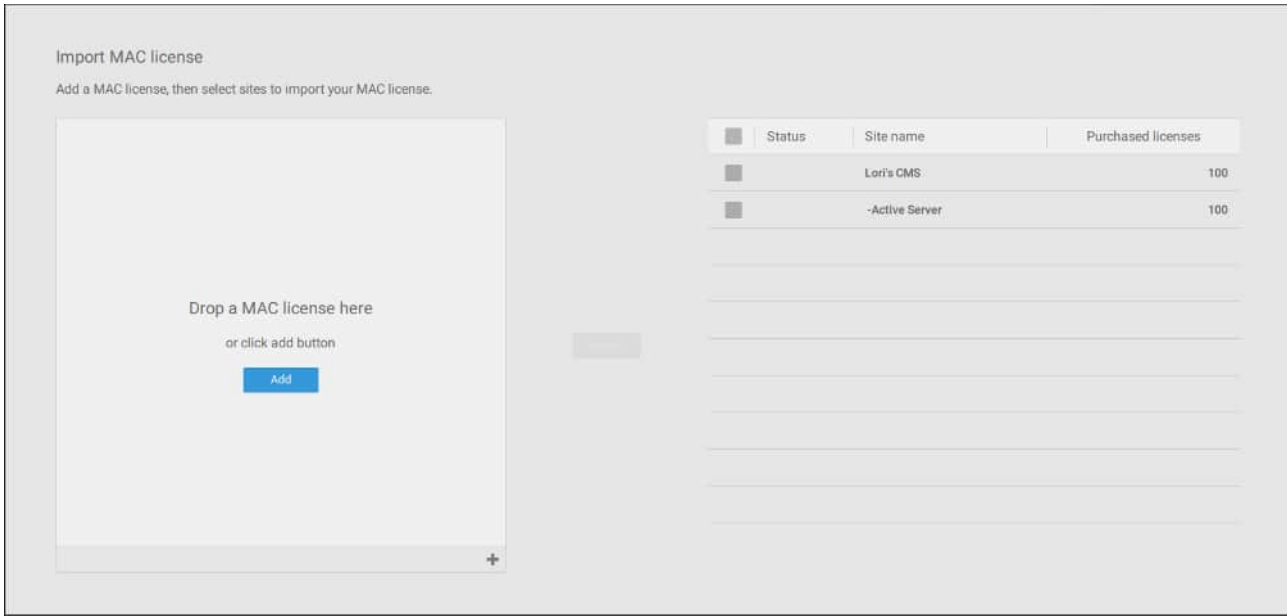

1-6. Select the license file.

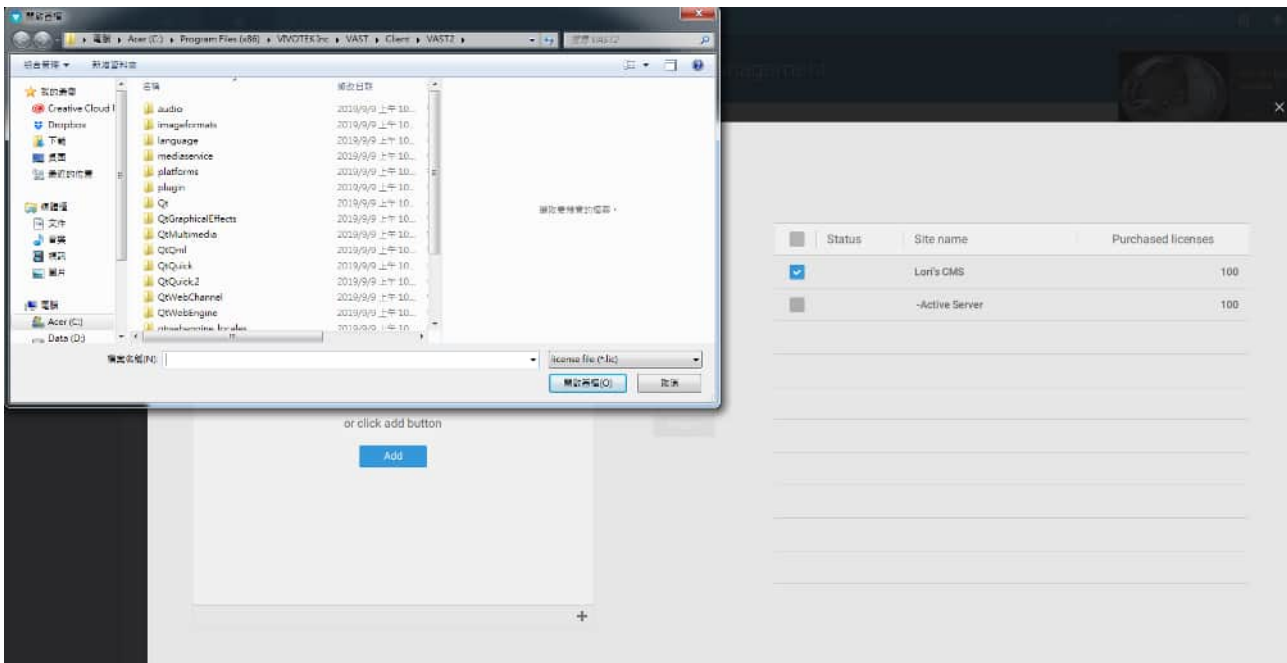

1-7. The selected file appears on screen.

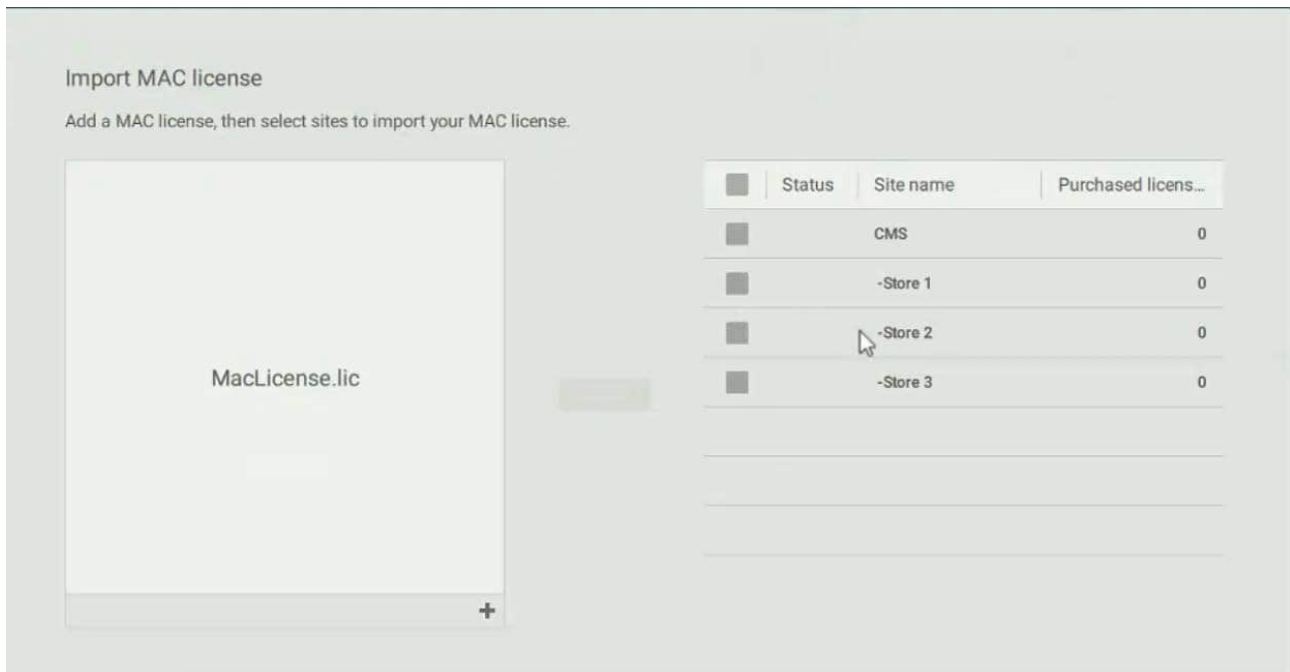

1-8. Select the target server sites to import the license file. When done, click the Import button.

MAC licenses are not bundled with server hardware. You can import licenses from the CMS server to one or multiple virtual machines running the VAST software.

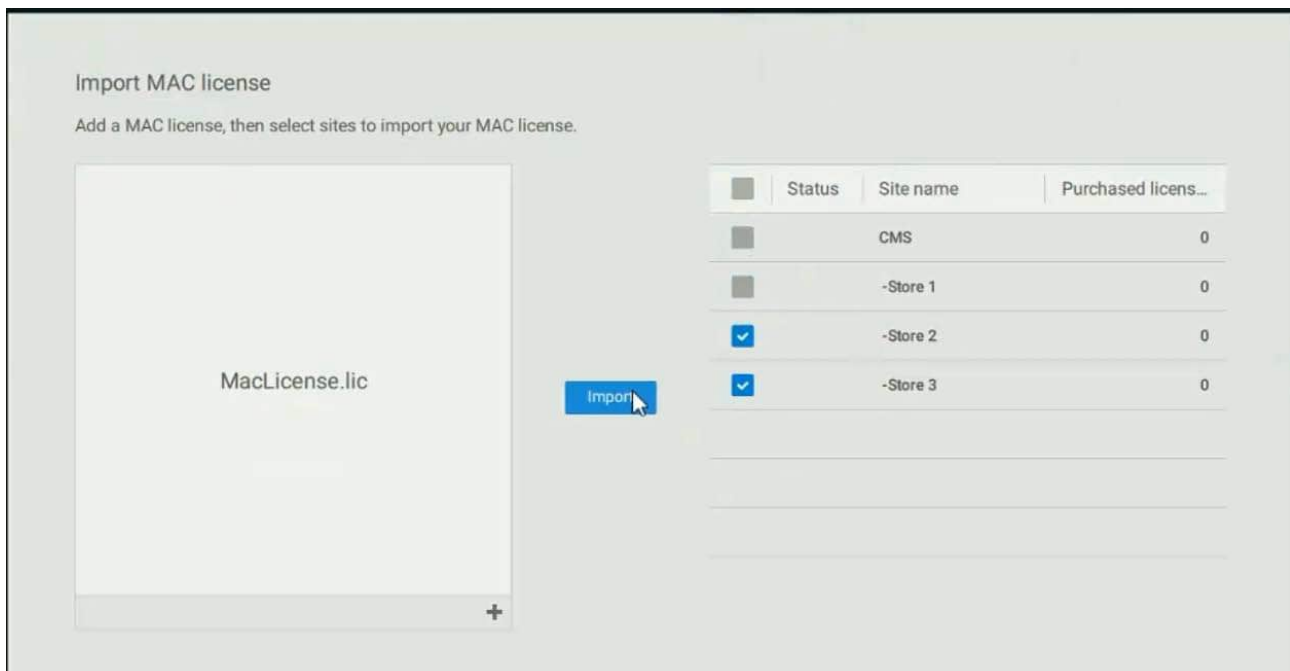

1-9. Select the virtual machines (sites) running the VAST server to import the license file. When done, click the Import button.

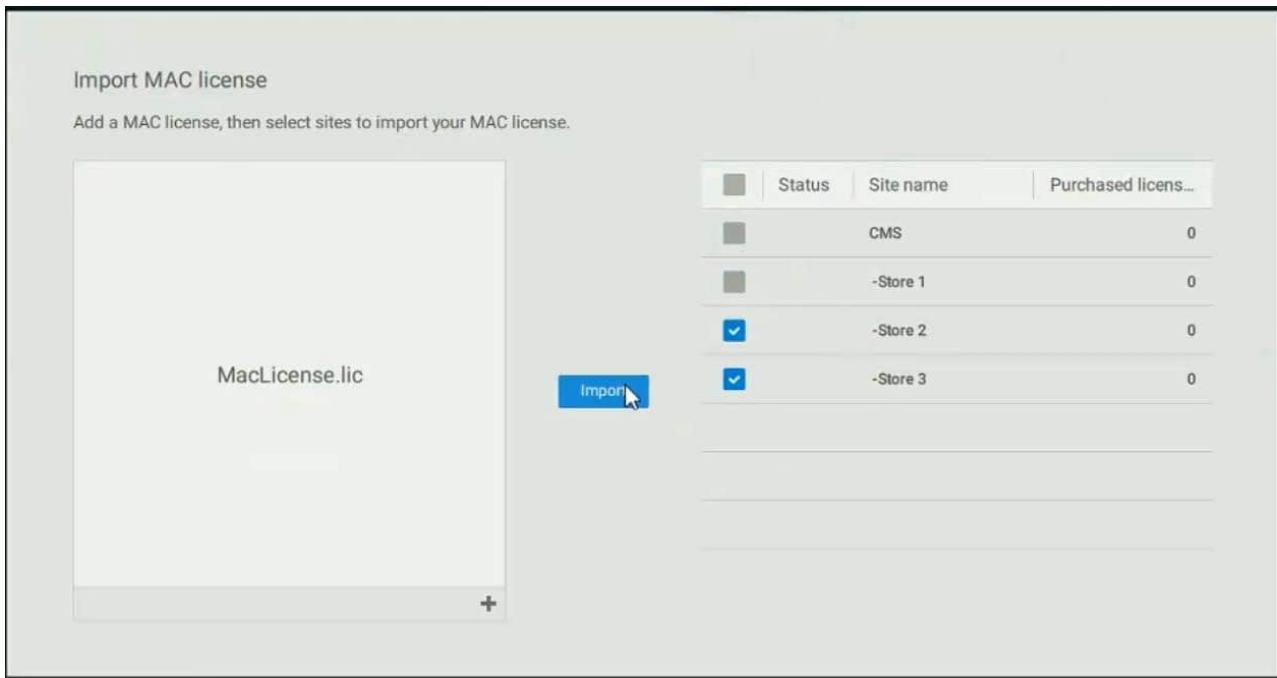

1-10. When done, the MAC licenses display on the license page as shown below.

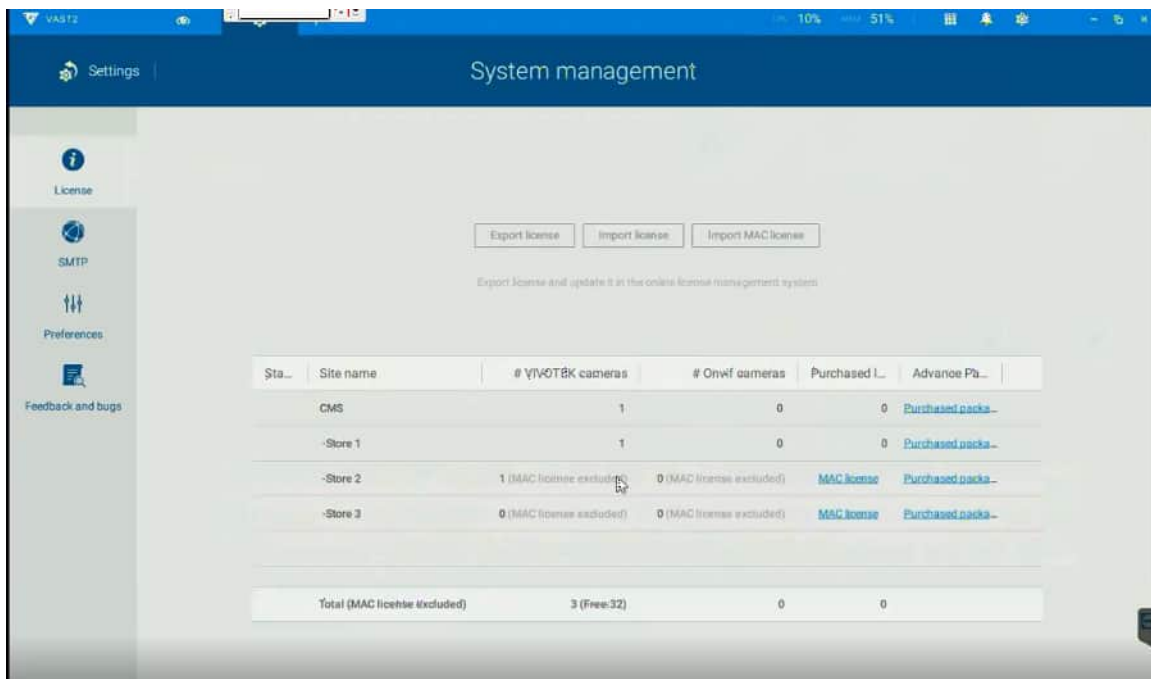

Reminders for VAST Software License

Limitations:

1. The Batch import/export function applies when a managing VAST server needs to collect and update the licensing information from subordinate VAST substations and itself. An enterprise may have a central management server and several VAST instances running in branch offices. In that case, the substations will be listed on the device list, and may not be displayed on a hierarchical structure.
2. The batch download/import function only takes effect on a VAST instance running on server, not on the Linux-based NVR.
3. The trial channels on VAST substations will not be available for use on a managing VAST server (one that manages multiple substations).
4. If you access a VAST deployment via a web console, the license related information will not be available.
5. In this revision, an identical software license applies to both VIVOTEK and other-brand cameras (ONVIF). You do not need to activate two different kinds of software licenses.
6. The Batch export update of the current license profile is supported.
7. If the VAST server is removed and then re-installed, the number of licensed channels remains intact.
8. If users plan to integrate the software licenses from previous dongle licenses, problems may occur if users changed the exported license file name.

Chapter 4 Settings:

4-1. Settings > System > Preferences

The Preferences page for VAST client and Station sides allows you to configure the following:

Client Setting:

1. Select the UI text language.
2. Configure a default destination for exporting video, snapshots, or configuration backups. The default is "C:\Users\Public\Documents\VIVOTEK Inc\VAST\Downloads". You can change the media format via the checkboxes.
3. Select the format for the snapshot as either JPG or PNG.
4. You can select the length of the Alarm-triggered videos by specifying pre- and post-alarm recordings.
5. You can designate the VAST client interface to automatically start once the client computer is started.

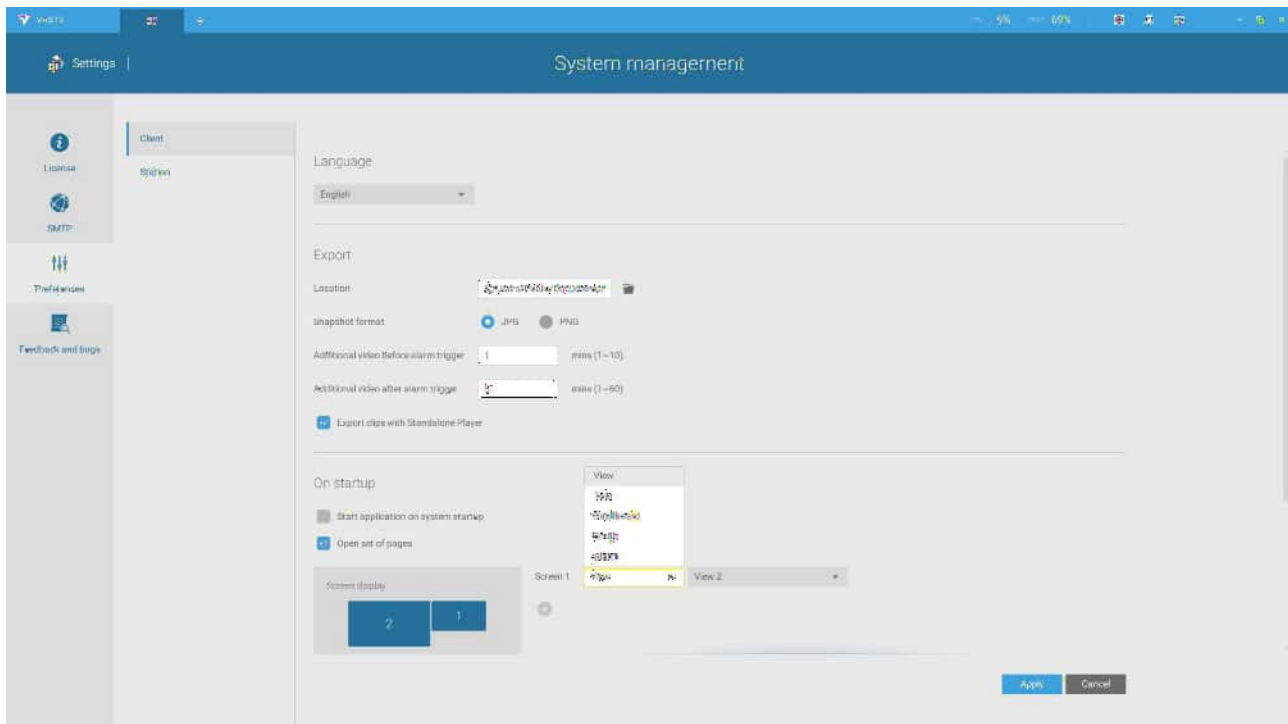

5. The default Live view, which may span across multiple monitor screens and display Live view, Tour, Dashboard, E-Map, or Alarm prompts. The precondition is that you should configure one or many views before making the Startup configuration.

Below is a server/client with dual monitors, you can select one view to be displayed on one monitor, or place an E-Map on another. Up to 8 monitors can be configured.

Click the Apply button for the configuration to take effect.

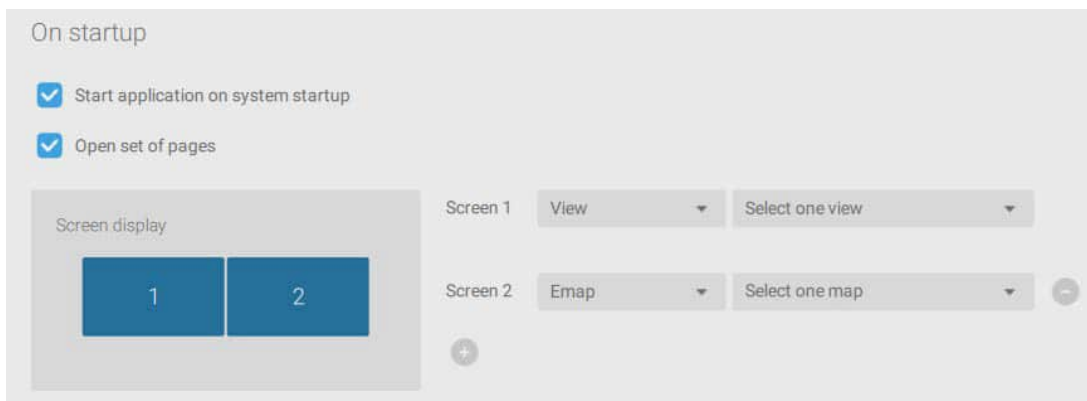

Station Setting:

- Display Watermark over video** - Administrators can select to display watermarks on the video feeds of the VAST clients. The opacity and display frequency can be adjusted.

Encrypted watermark for authentication:

To ensure your video is authentic and has not forgerized, adding an encrypted watermark on the data stream can be achieved with a customized password. You can use the Standalone Player to verify which frames in the video footage have been tampered with.

If enabled, the following will be displayed: **camera name + substation name + VAST2 user name + user computer current time**. The purpose of watermark is to preserve evidence if the video screen is recorded using cell phones or other devices.

Station Setting:

2. **Digital watermark** - To prevent forgery of recorded or exported video clips, and to prove the validity of surveillance evidence, digital watermark can be appended to recorded video.

Note that only non-administrator users will see watermarks.

To enable text watermark, use the slide button. Use the Preview function to tune the text opacity and text frequency display on screen.

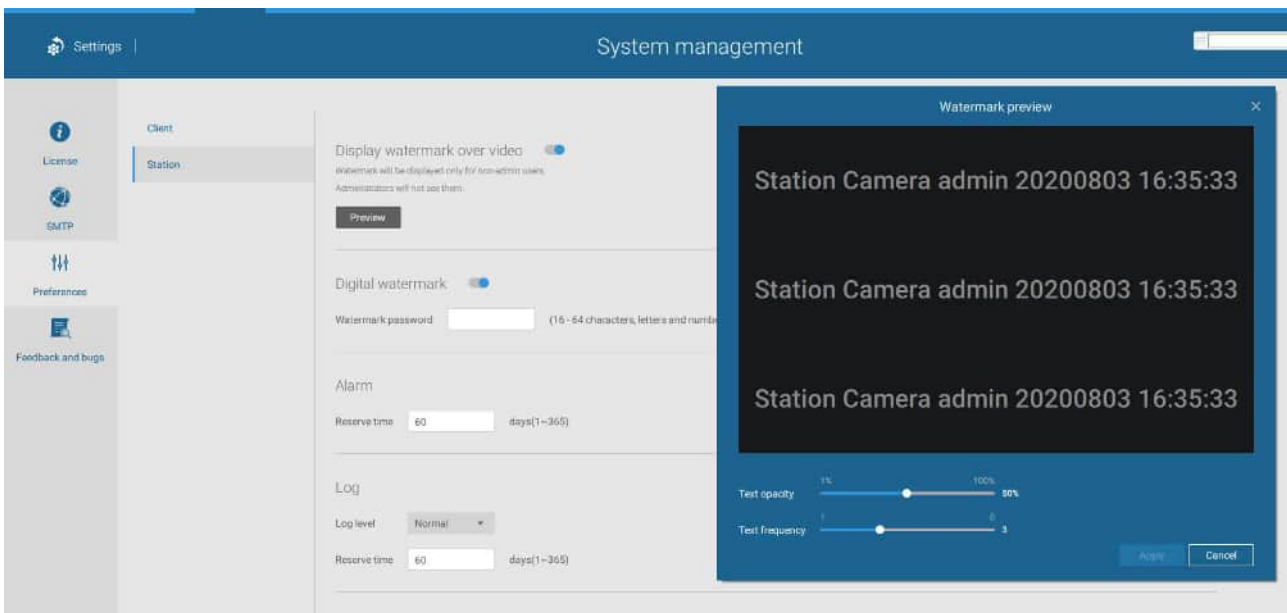

To enable Digital watermark, enter a password that is at least 16 characters long. Once a valid password is available, you can click the Apply button to preserve your setting.

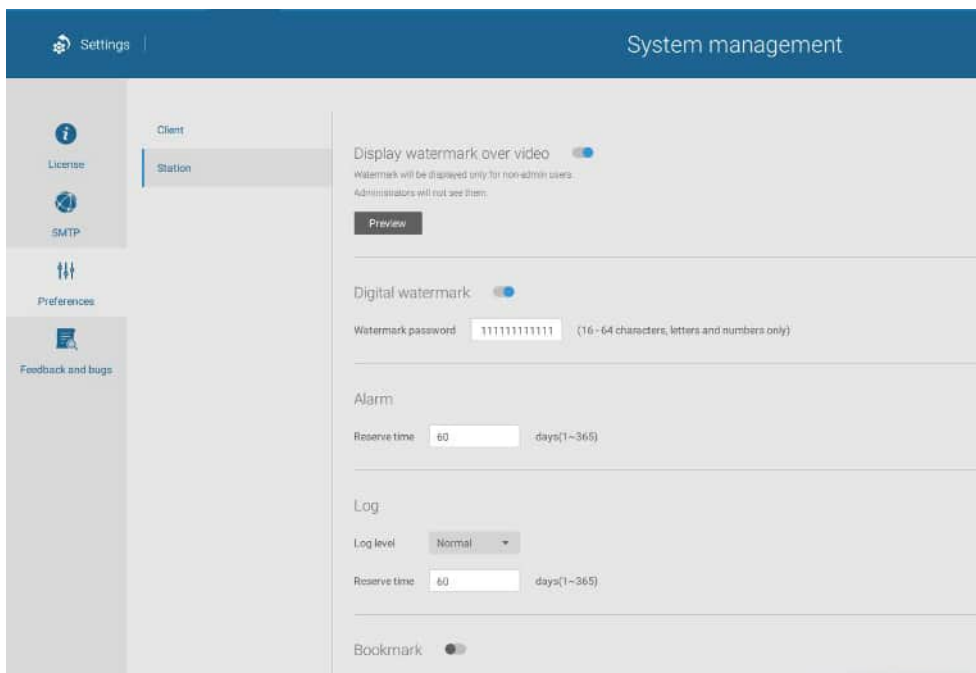

When you export a video clip, a StandalonePlayer is generated with the exported files.

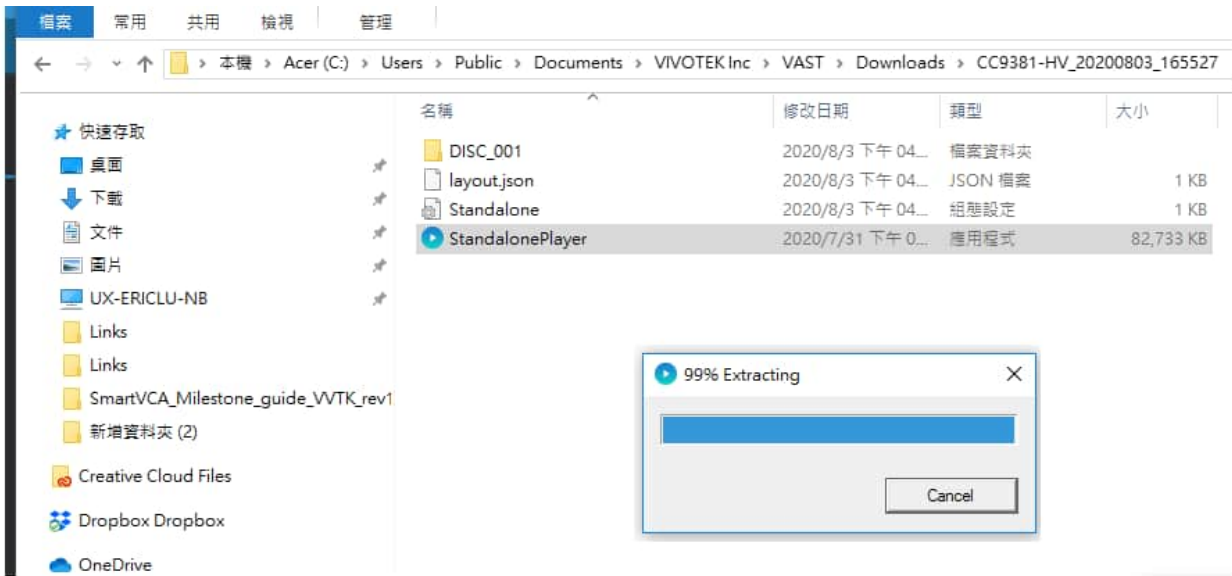

Right-click on the StandalonePlayer screen to display the "Verify watermark" function.

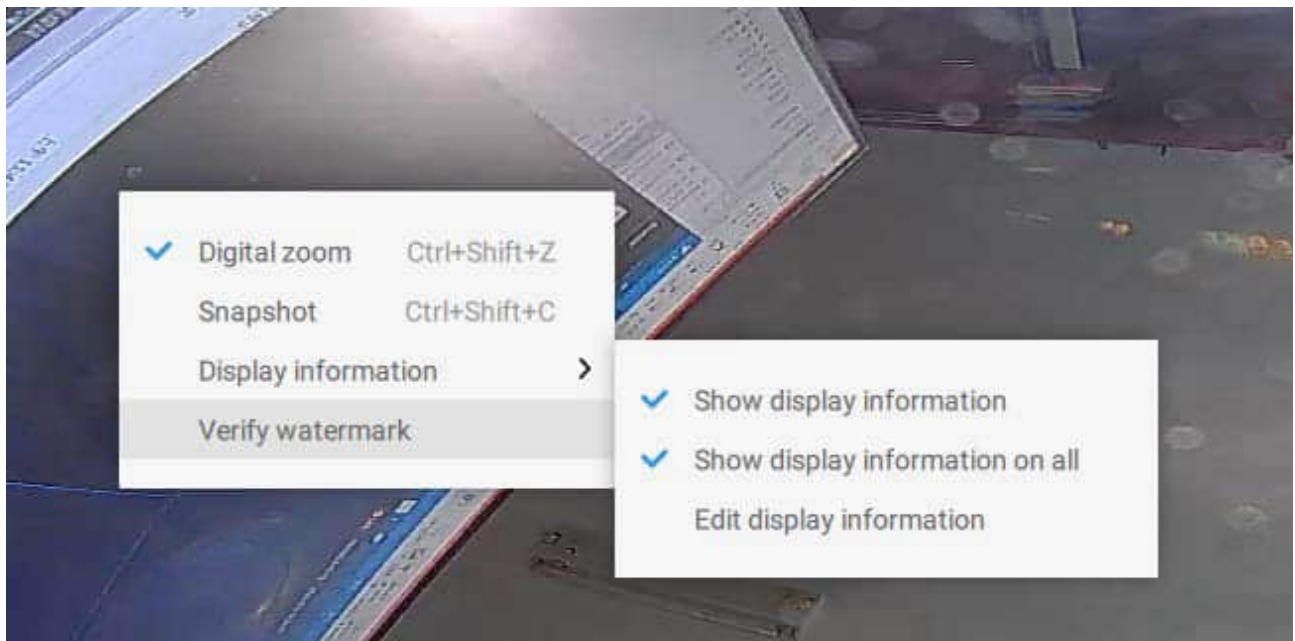

The Verify screen will display. Enter the pre-configured password. Click Verify.

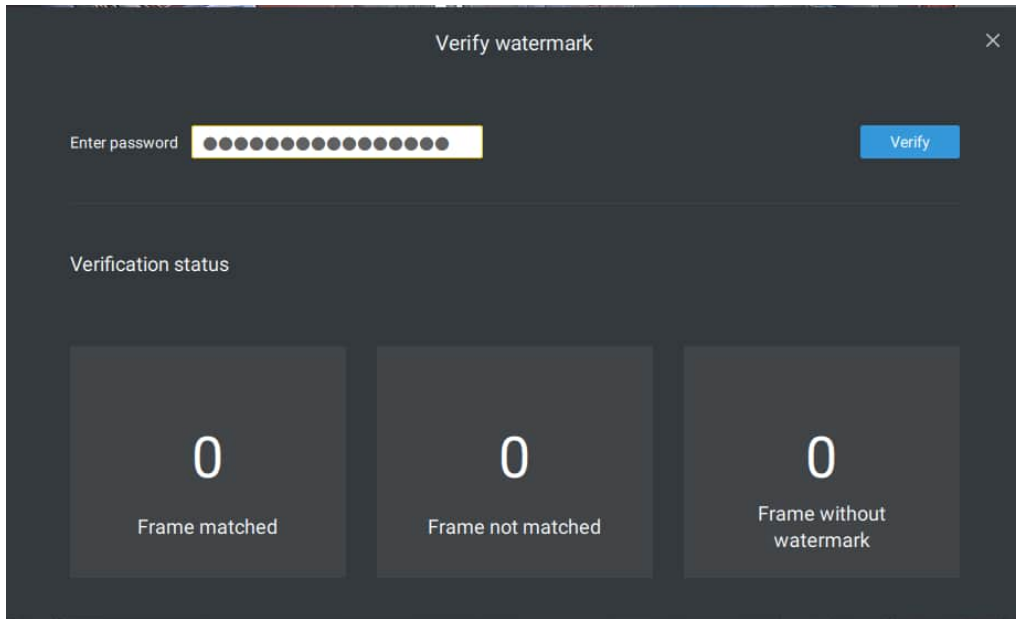

The below result shows that the video is authentic and has not been forged.

Frame matched: Your video was exported with the digital password, and you entered the correct password.

Frame not matched: Your video was exported with the digital password, and you entered the incorrect password.

Frame without watermark: a. If your video wasn't exported with the digital password.

b. If your video was exported with the digital password, and your video has been tampered.

If the numbers in the "Frame not matched" or "Frame without watermark" are not zero, it means your video is probably not correct.

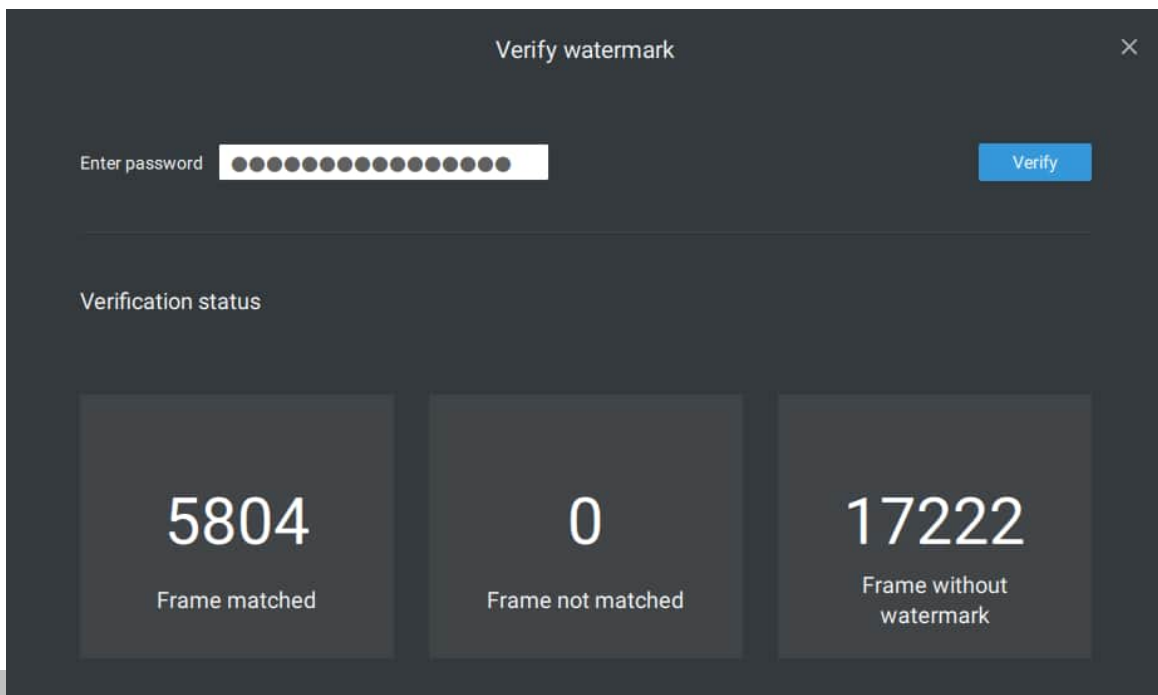

3. **Alarm** - Reservation time: Configure the preservation time of the alarms and logs. Note that some alarms can be triggered with recorded videos. Configuring a preservation time can help reduce the use of storage space on server.
4. **Log**: Use the menu to configure the preservation time of the Major, Normal, or Minor logs.
5. **Bookmark**: Configure the days of preservation for bookmarks.
6. **Data magnet**: Configure the days of preservation for data related to Data Magnet.
7. **Trend Micro events**: Configure the days of preservation for events related to cyber security.
8. **Database**: Configure the destination of the database folder. The database contains information for system log, alarms, Bookmarks, data magnet, VCA reports, POS transaction data, snapshots, and Trend Micro IoT security information.

4-2. Settings > Device > Cameras

In addition to the add device process during the initial setup, you can add more cameras or arrange the device list in Settings  > Cameras.

Below are the locations of the functions for adding devices to the VAST server.

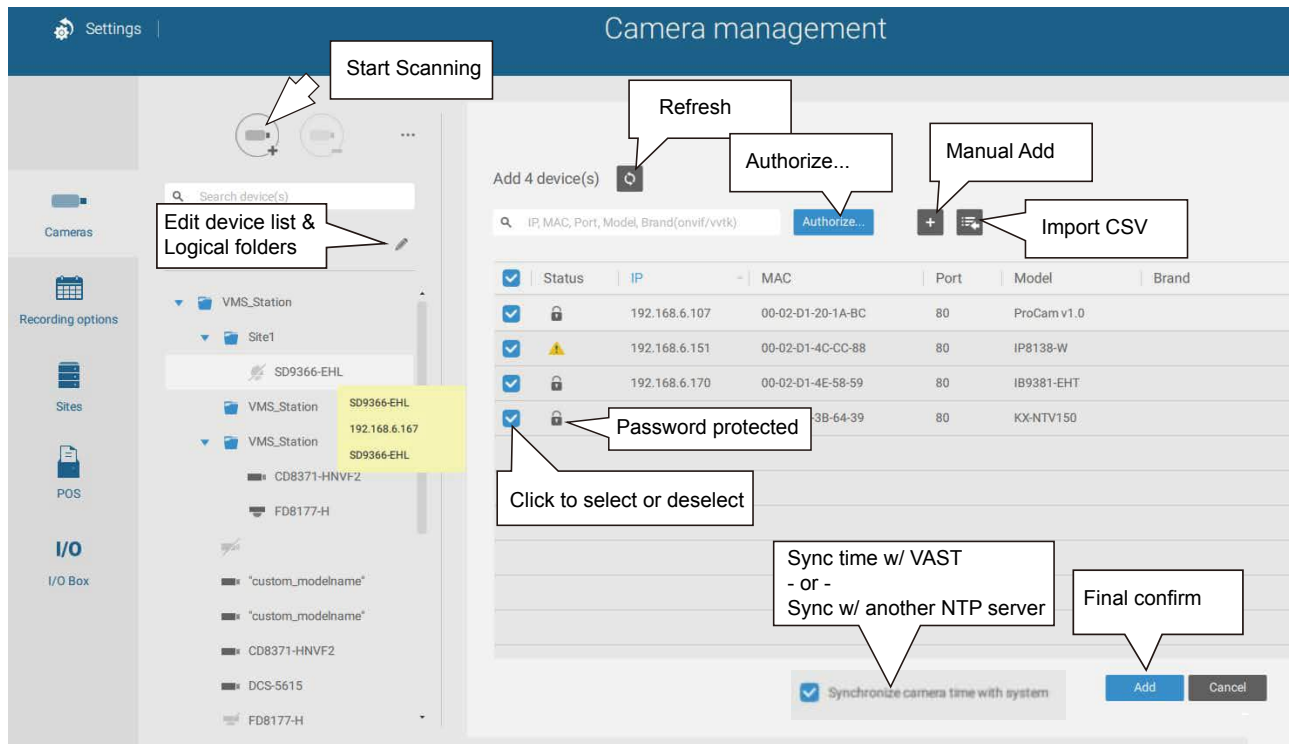

Note that you must know the credentials for password-protected cameras. You will not be allowed to enlist cameras that come with unknown credentials.

For cameras outside the local network, you can manually enter its IP address, or use a pre-configured device list to automatically introduce new devices.

If all devices come with the same credentials, you can select these devices and click Authorize to enter the credentials.

- Retrieve RTSP streaming on specific port: The default port for RTSP streaming is 554. If you want to change this port, please check this item and fill in a desired port number.

Streaming URL

This is an optional feature. You can enter a camera's IP address to add a camera's RTSP streaming for live view and recording, and playback.

To insert a camera using the URL-like command,

1. Select the camera Brand as "RTSP."

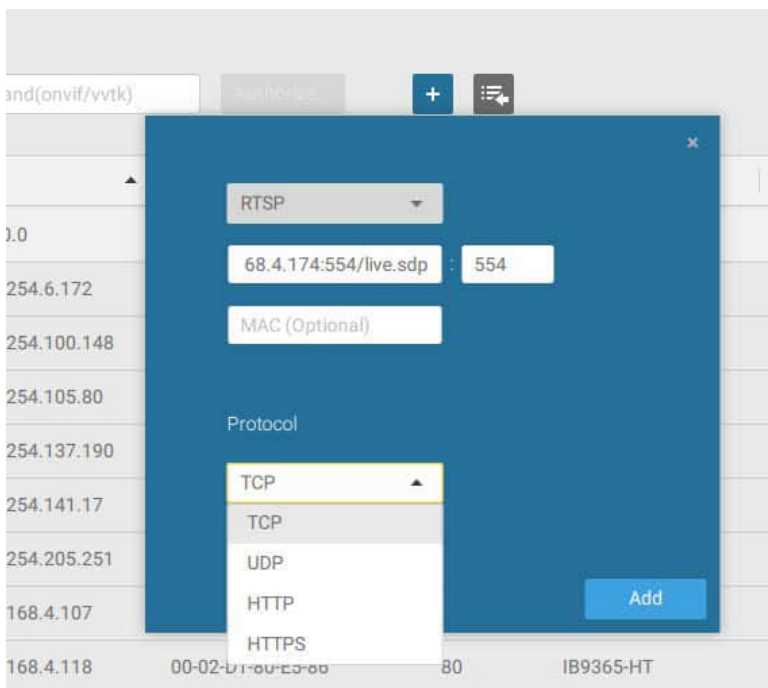

2. Enter the camera's IP address.
3. Enter the camera's MAC address as printed on the camera label, or one found by the Shepherd utility.
4. Enter "554" in the Configuration port.
5. Enter "live.sdp" in the URL field, as this is part of the original RTSP streaming command: "rtsp://172.18.204.58:554/live.sdp". If streaming stream #2, enter live2.sdp.
6. Select a preferred protocol.

Note that the free 32 channel licenses does not apply when inserting a camera using the URL command. Only the live view, recording, and playback functions are supported if thus connected. All other functions are not supported, such as auto streaming size or changing to another video stream. Neither are camera DI/DO supported.

- For administrators who need to synchronize device time with a NTP server, he can deselect the "Synchronize camera time with system" checkbox.

When adding cameras via ONVIF or RTSP protocol, you can select to synchronize its time setting with your VAST server or to keep the camera setting. The default is using the camera time setting.

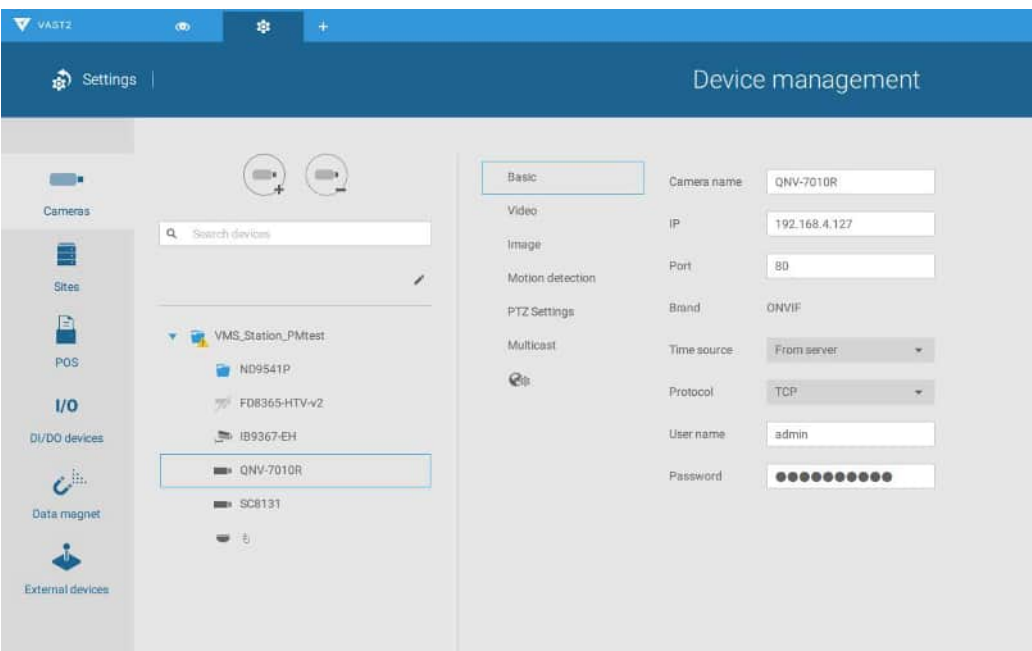
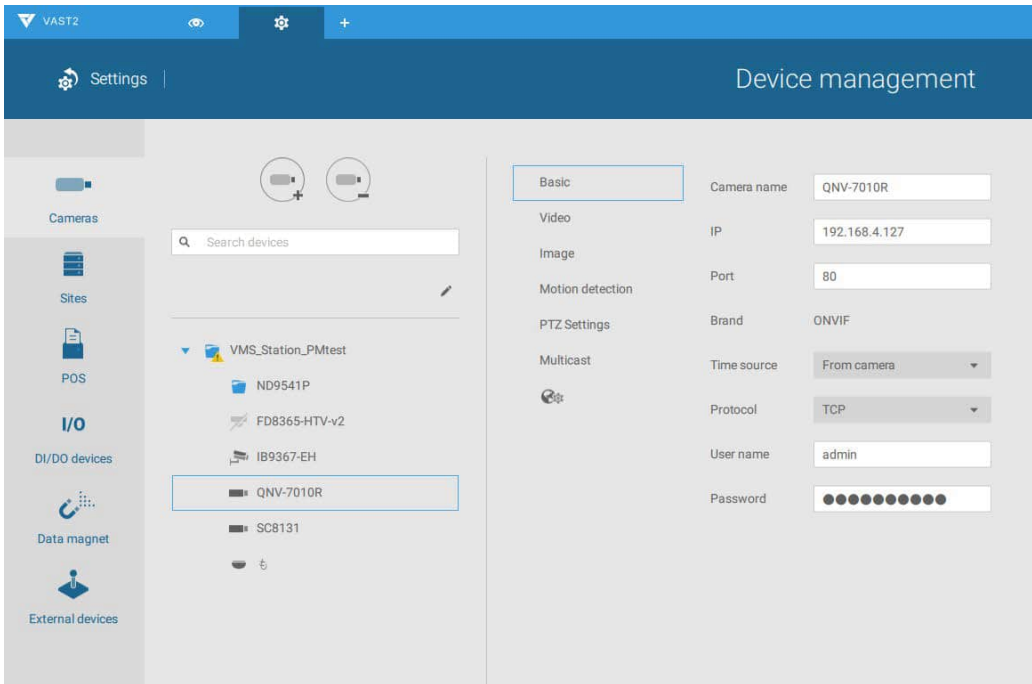

4-3. Logical Folders

The Logical Folders allow you to re-define the logical relationships between the real-world deployment and the physical devices (cameras). For example, according to your deployments, you can designate several cameras to be listed under a logical sub-directory named as "Building A," and the other cameras into "Building B." In this way, you can re-arrange your cameras and devices on a tree view that is geographically more accurate.

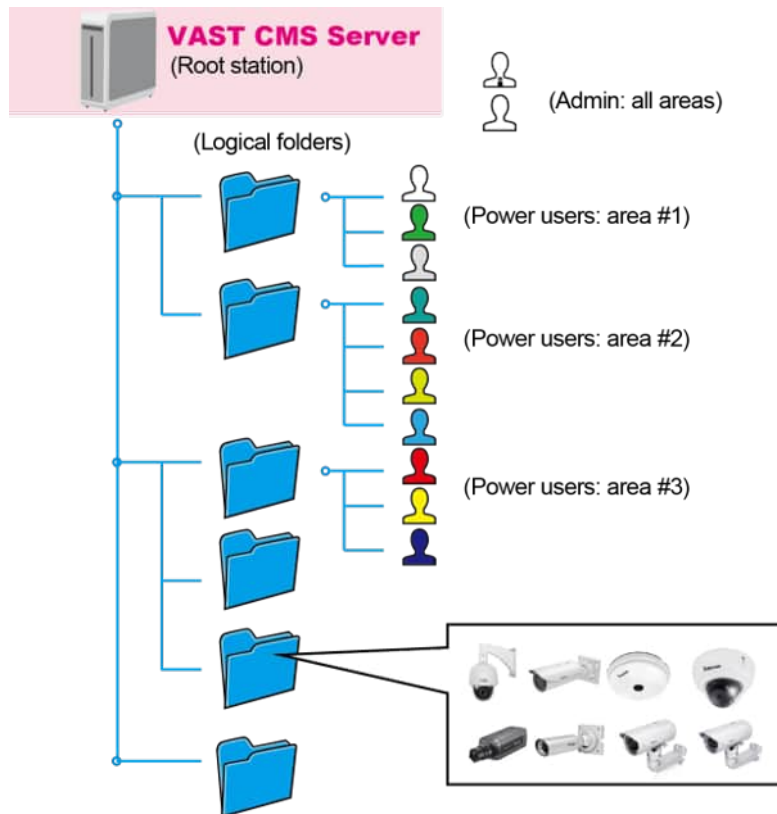

To create logical folders,

1. On the Settings > Cameras page, click the Edit  button.
2. Click on the Add a folder button.
3. Enter a name for the folder, e.g., 1st floor, 2nd floor,... according to your needs as shown below.
4. Repeat the process to create more folders.
5. Make sure you enlisted all cameras in your deployment. You can start moving cameras to specific folders. Click on the Move Selected Items button.

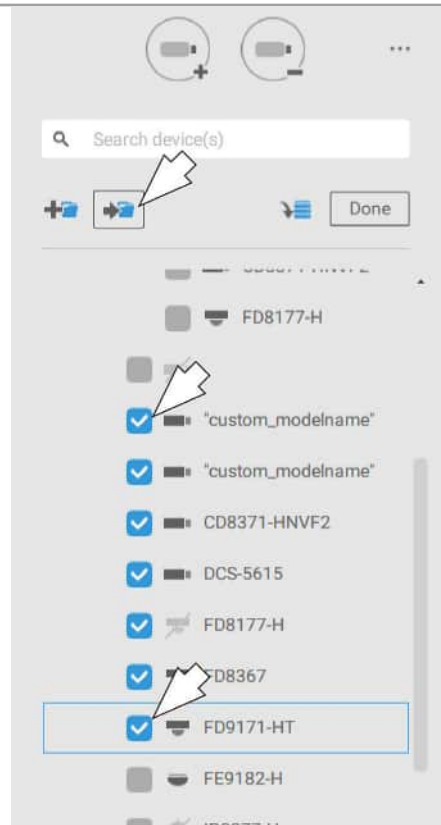
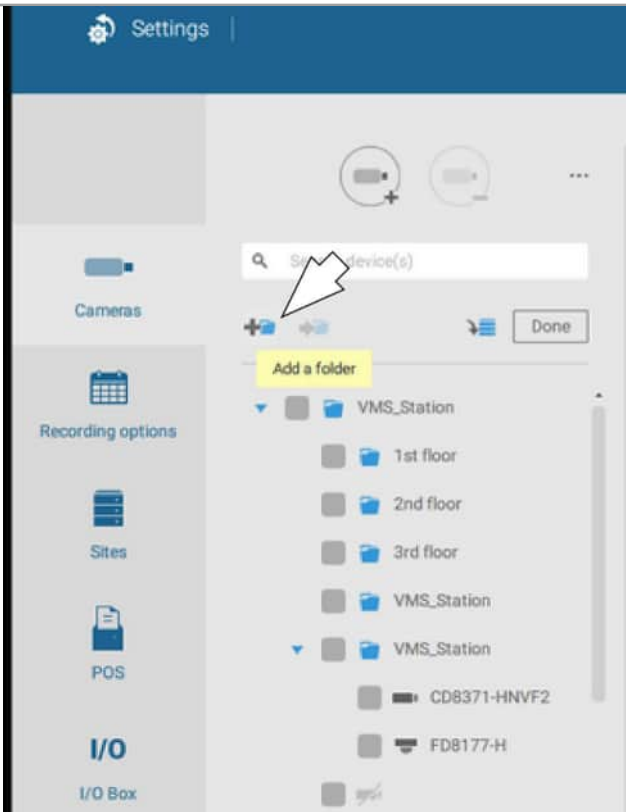

6. Select a logical folder to move the devices to. The selected devices will be listed under the logical folder you selected. Repeat the process to move cameras to each logical folder.

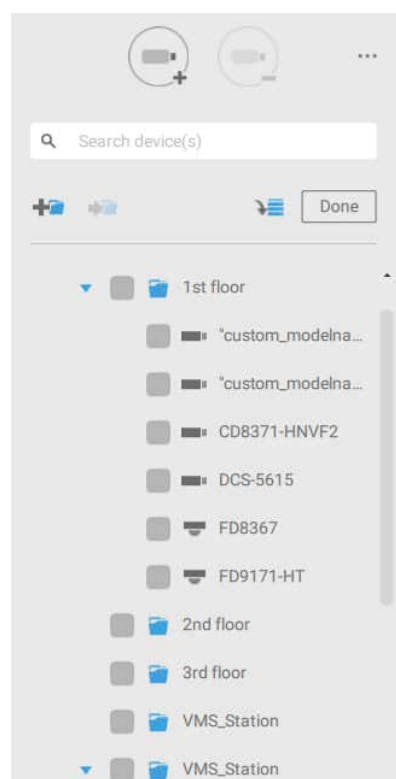
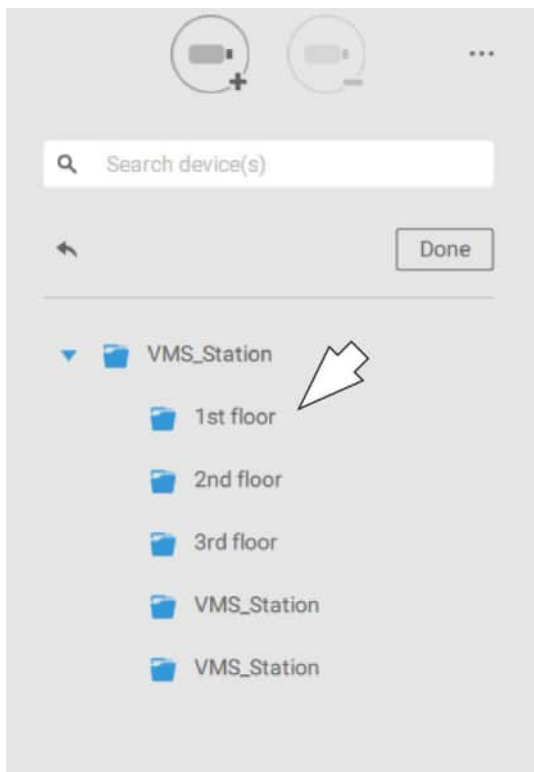

You can also use the add device button to select devices from the list and move them to a specific folder.

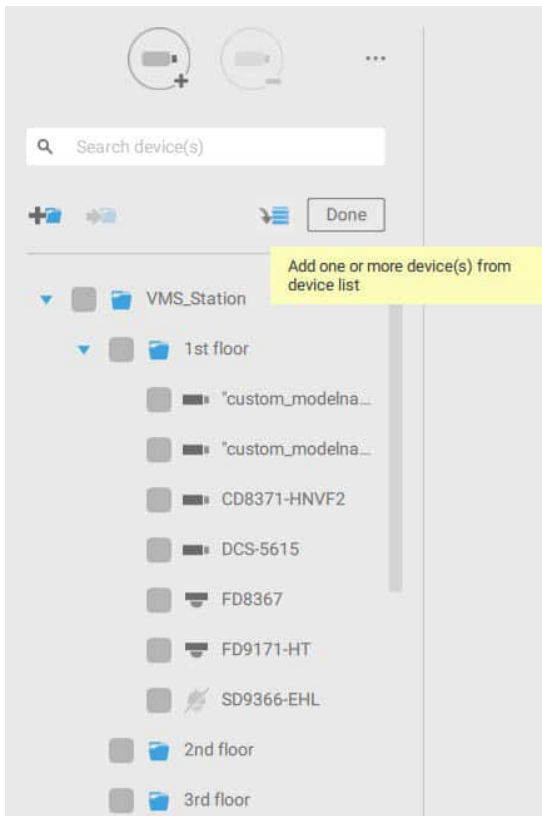

Return to live view, and you can see the configuration change takes effect.

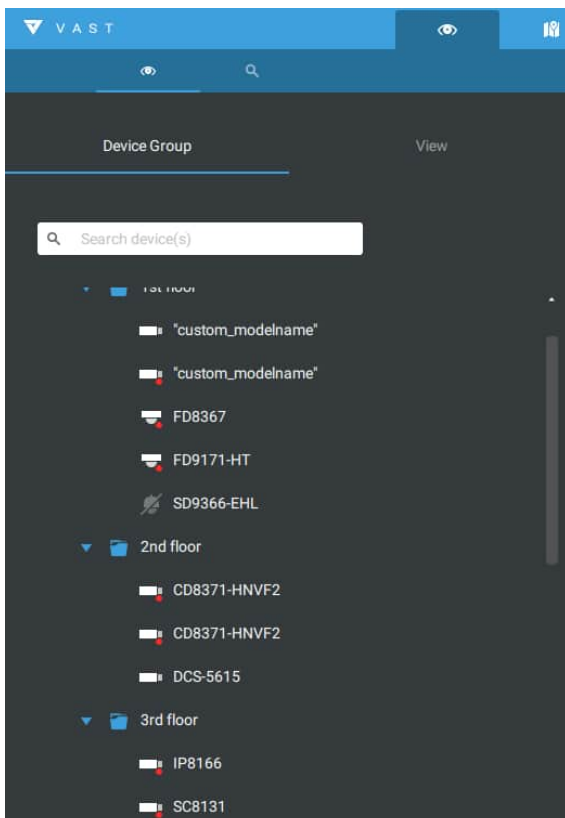

4-4. Settings > Recording > Recording Options

Click Settings > Recording options. The Recording options window will prompt.

You can configure recording schedules or select the storage options, including the configuration of an external NAS storage.

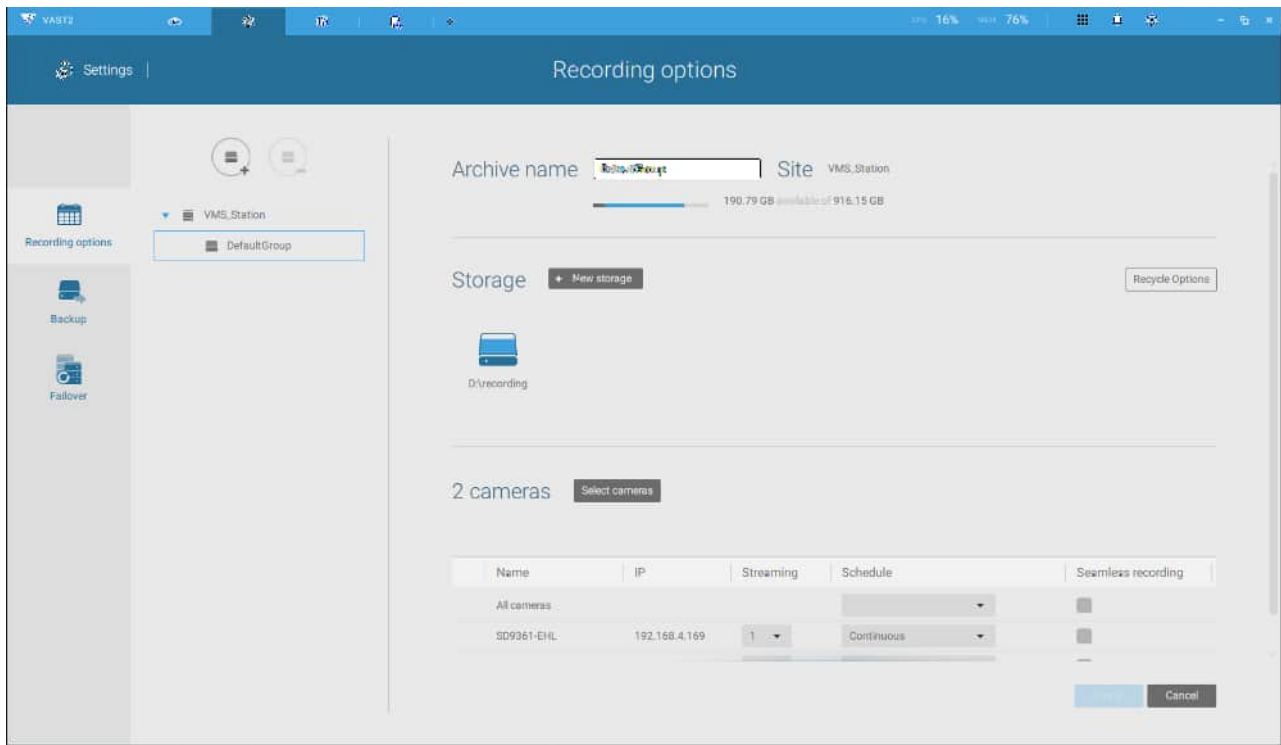

Click on any of the options on the Schedule panel for a recording option: Continuous recordings, Events only, None, or Customize.

You can manually create a recording template using the New template  button.

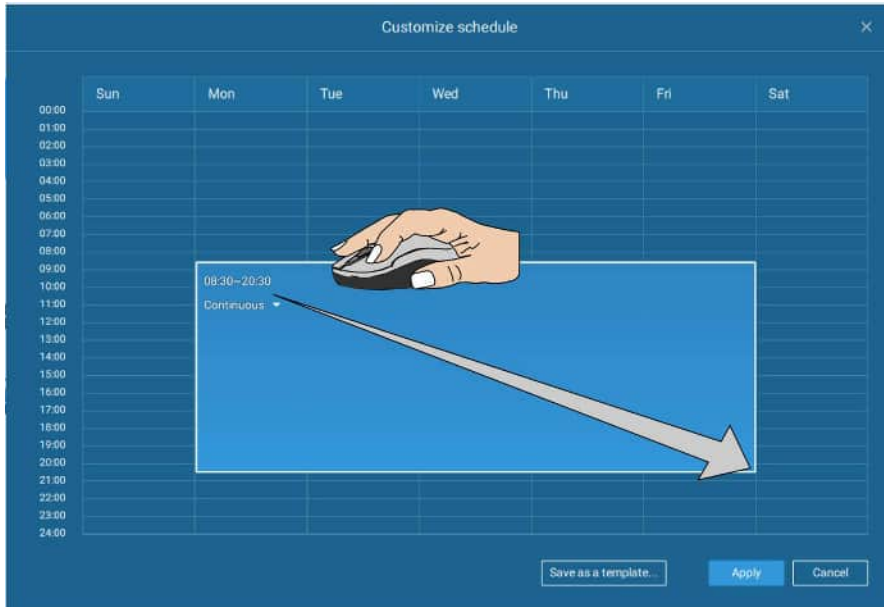

Click and hold down on the time cells, and drag the mouse to include the time span of your preference. The minimum selectable unit is half an hour. You can select multiple time spans on the template. Enter a name for the template, and click Add to save your template.

The same configuration window apply to both the Schedule template and the customize schedule windows.

Make sure a Schedule mode is selected when you leave this configuration step.

4-5. Settings > Recording > Backup

The Backup function allows you to regularly back up the video recordings of one or multiple cameras to local hard disks or a Network Attached Storage device. Currently, the VAST2 server does not support backup to external storage devices such as a storage devices connected via Fibre Channel. VAST supports backup to an external storage attached through a USB 3.0 connection.

Note that the alarms associated with individual cameras will not be backed up.

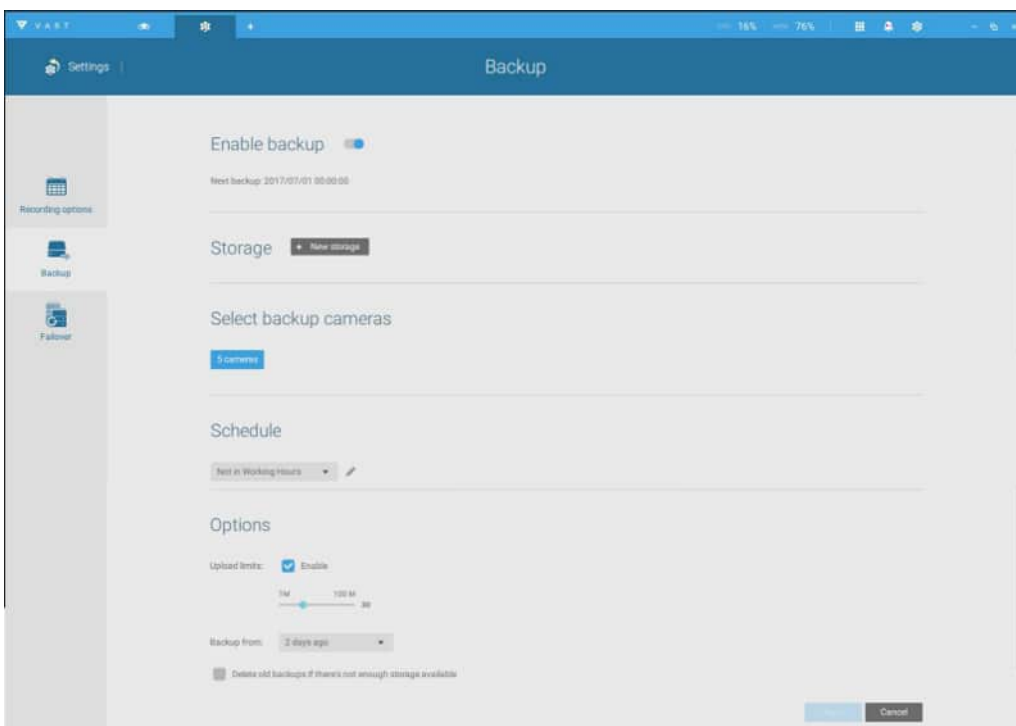

To enable a backup schedule,

1. Enable the backup by selecting the "Enable backup" slide switch.
2. Click to add New storage. A configuration window will prompt showing all accessible storage. Click the NAS tab to enable access to a network share.

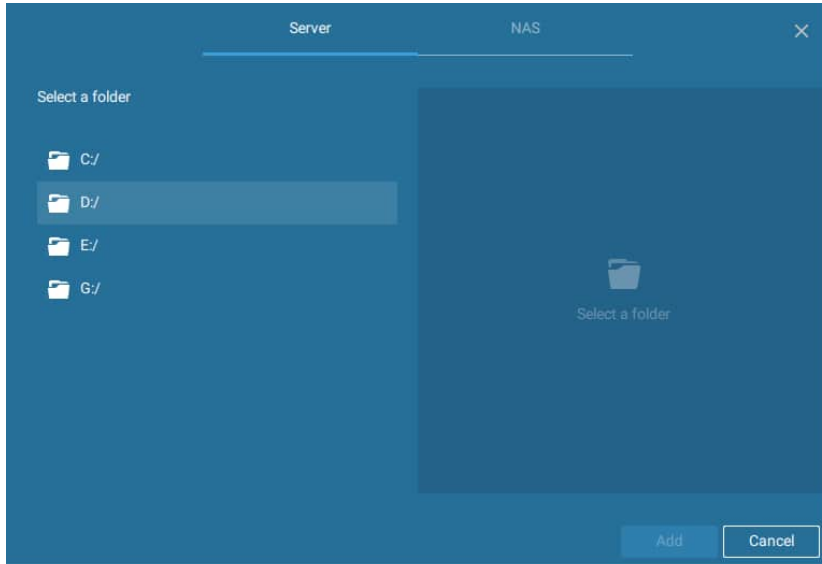

3. Select the cameras whose videos will be backed up.

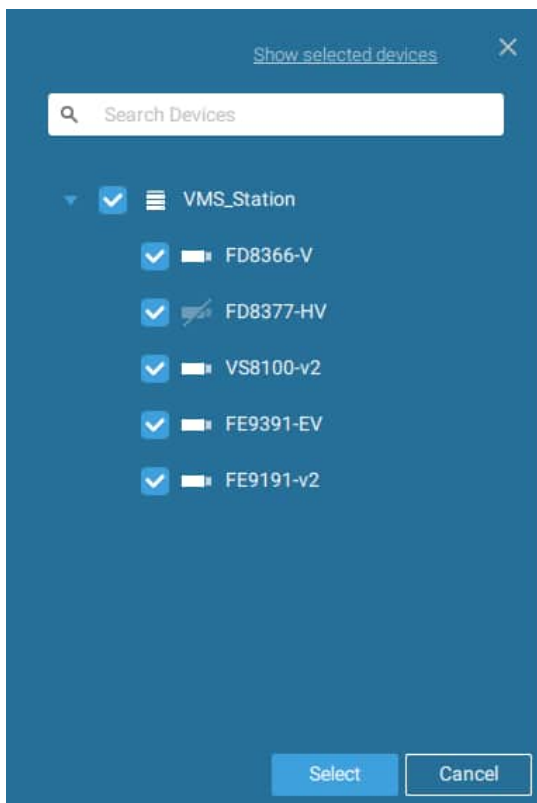

- Select or configure a new schedule template for the backup process to take place. You can select a time when the network load is low, such as the off-office hours, to avoid network congestions.

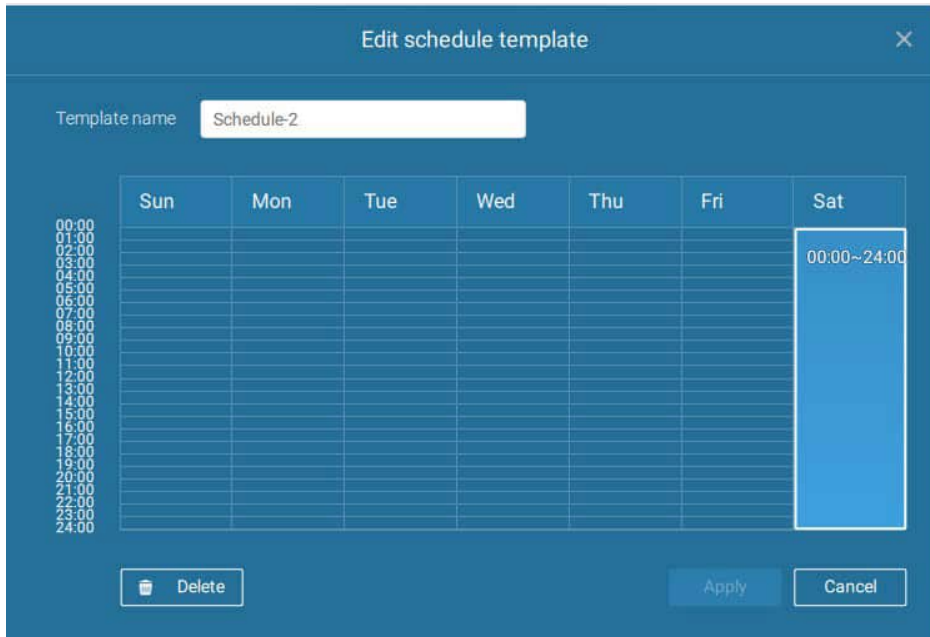

- On the Options pane, you can configure an upper bandwidth threshold (in Megabytes) for the backup operation (for all selected cameras/channels).

You can select the extension of time, such as starting from how many days ago, of your backup task. You can select to remove old backups when you run short of storage volume.



Storage

By default, VAST will check there is a D: drive. If not system drive C: will still be defined as the first storage option. Other disk drives in the system, and the default storage volume (configured in the initial setup) will be listed.

You can add a NAS storage's share volume as the additional storage option. Enter the necessary information for access to a network share. Enter and select a NAS path. The share will then be available for video recording.

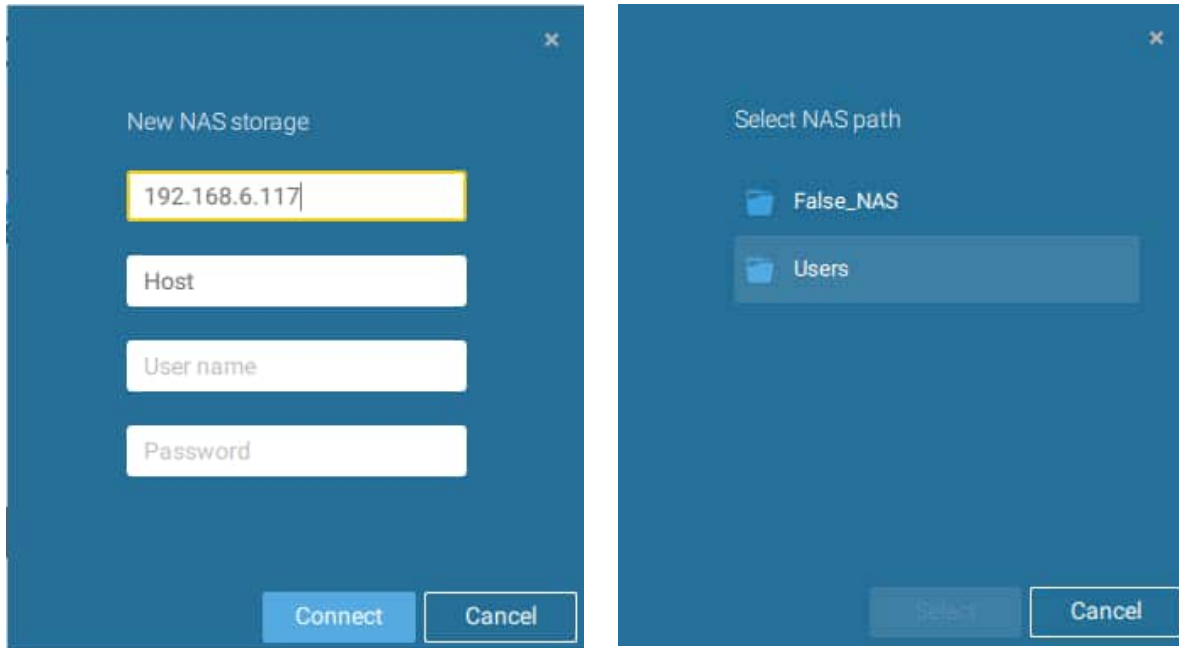

Select storage volumes each by a single click.

Click **Ready to use** to continue.

4-6. Settings > Device > Sites

The VAST2 allows a deployment consisting of multiple VAST instances at different sites. A VAST server can be selected as the CMS (Central Management Server) to manage sub-stations in a hierarchical structure.

Each individual VAST station manages its own surveillance deployments. To build a hierarchy, proceed with the following:

1. Open the VAST 2 client on a sub-station.
2. Enter Settings > Sites.
3. Enter a TCP **Port** number if your network configuration requires a different port.
4. Select **Allow CMS to access this site**.
5. Click **Change password**. This password will be used to authenticate the connection between a CMS VAST server and sub-stations.

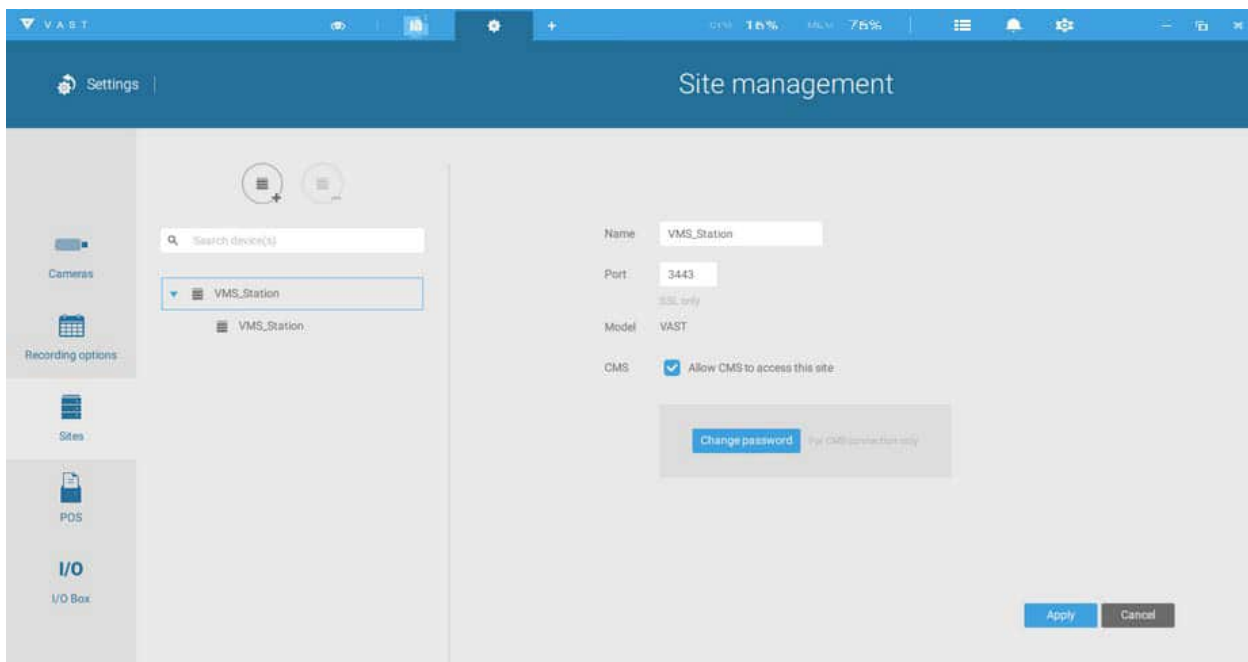

6. Click the **Apply** button.
7. Open the VAST 2 client on the server chosen as the CMS.
8. Click the Add sites  button.

- You can click the Search button if the sub-station is reachable in a local network, or manually enter the IP address, and password for making the connection.

New sites

IP/Domain name

Port SSL only

Add as a redundant server

CMS password

- Enter the password you configured for the Sites configuration, and then click the [Authorize](#) button.
Click the [Apply](#) button for the configuration to take effect.

Settings | Device management

General

Sites

POE

I/O

DI/DO devices

Data magnet

External devices

VMS2 Station

Juofan

Add 1 sites

Status	Name	IP	Port	Model
<input type="checkbox"/>		192.168.4.169	443	ND9322P
<input checked="" type="checkbox"/>		192.168.4.161	443	ND9322P

The sub-stations and its subordinate devices should be immediately listed under the CMS station. You can create separate views to place the sub-stations' cameras.

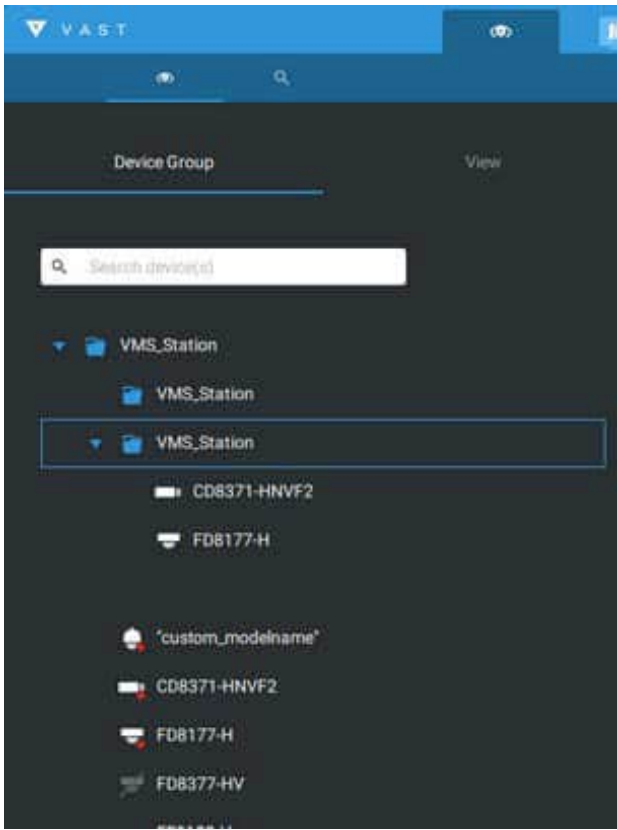

When you want to enlist an NVR into your configuration, please remember to enable the access from VAST server in the NVR's Service page.
 The connection between VAST and NVR is made via encrypted https.
 If the connection port is changed to a non-SSL port, the access from VAST to NVR will fail.
 For adding the ND series NVR, use port 443.

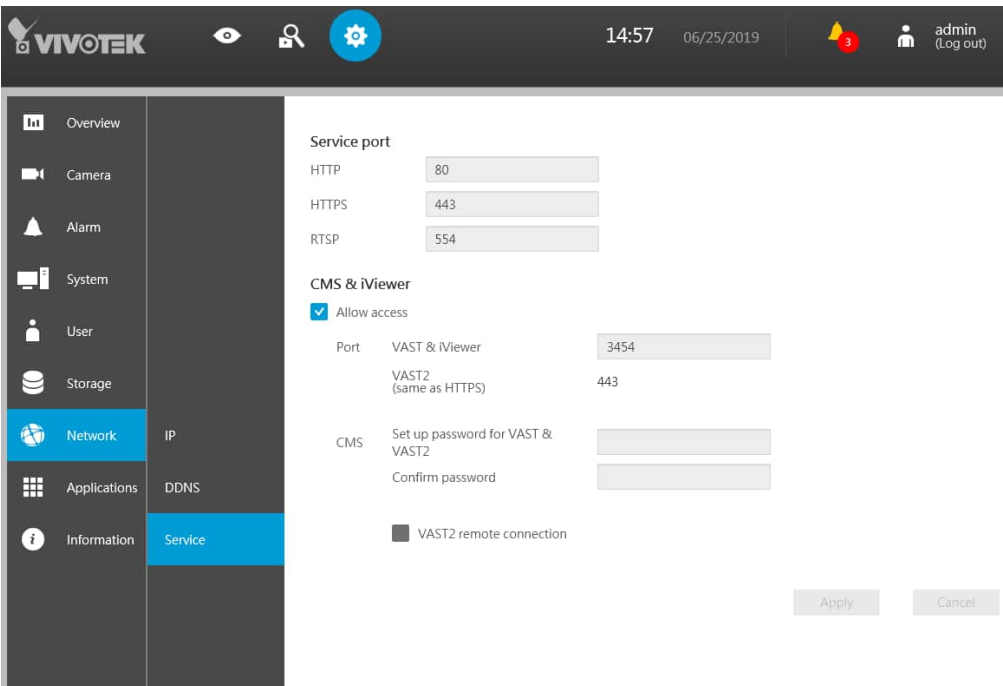

Multicasting

The VAST2 supports multicasting of live streams from server to clients. If multiple VAST2 clients demand live videos from the same camera, multicasting can help save considerable system resources.

Multicasting should be enabled on a VAST server and also on individual cameras.

There are prerequisites:

1. Both the VAST2 server and clients have to be revision 2.7 or above. If any of them is running revisions before 2.7, client connections will crash.
2. Multicasting is not supported under the following conditions:
 - * A CMS local client can only access the live stream from the cameras managed by the CMS server using unicast connections.
 - * If the need arises for access to cameras managed by VAST sub-stations, the multicasting configuration should take place on the sub-stations instead of on the CMS server.

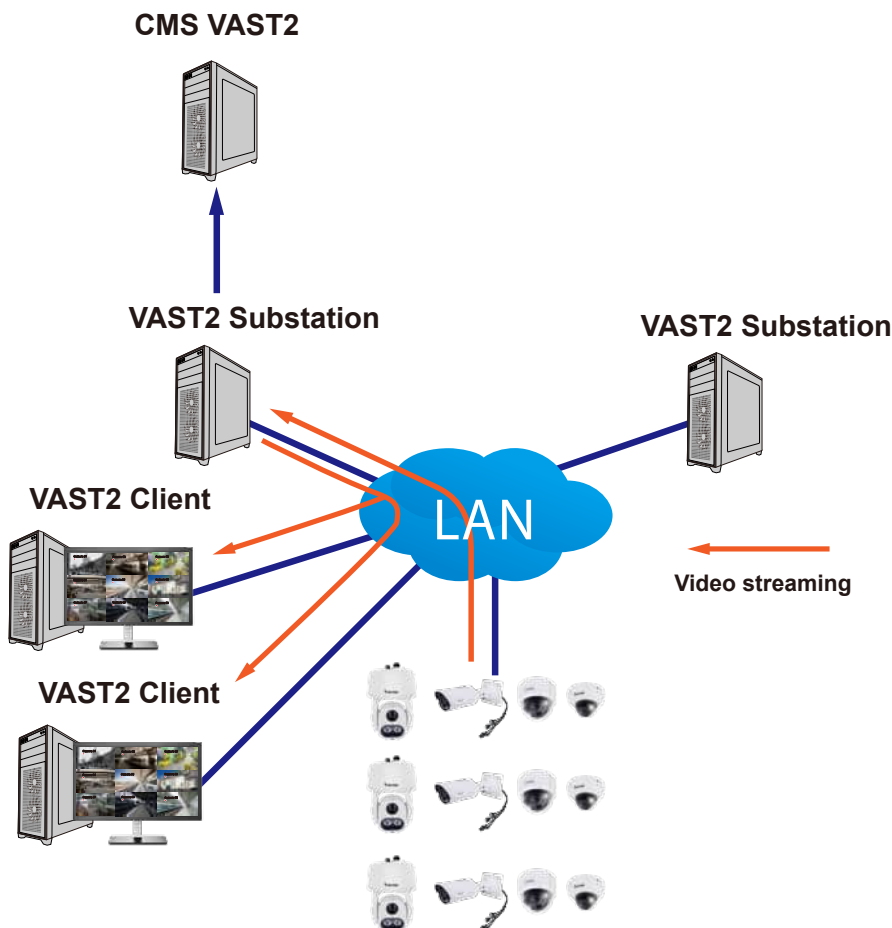

- * If the streaming connection for a sub-station is configured as **CMS Relay**, you should configure the multicasting settings on the CMS server.

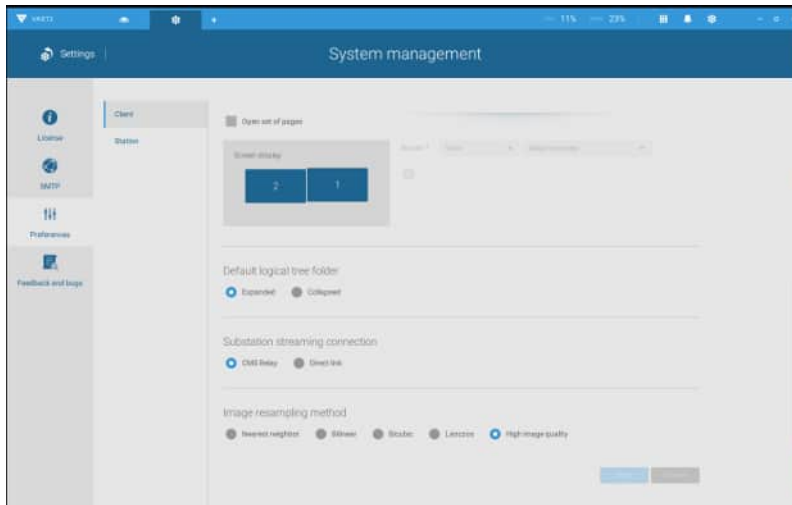

- * To enable multicasting, your network infrastructure must support the IP multicasting standard IGMP (Internet Group Management Protocol). Your server and clients should be on the the same network segment.
- * Multicasting is only possible for live streams, not applicable to the recorded video or audio.
- * Multicast streams are not encrypted, even if the the recording server uses encryption.
- * The IPv4 multicast address range is: 224.0.0.0 to 239.255.255.255.
- * A layer 2 network switch that supports IGMP is required in the configuration.

To enable Multicasting on a VAST server:

1. Enter Settings > Device > Sites.
2. Single-click to select a server for which you want to enable the Multicasting.
3. Click the checkbox to enable the configuration and enter the multicast address.
4. Click the **Apply** button.

Starting the Multicasting service will restart the VAST server.

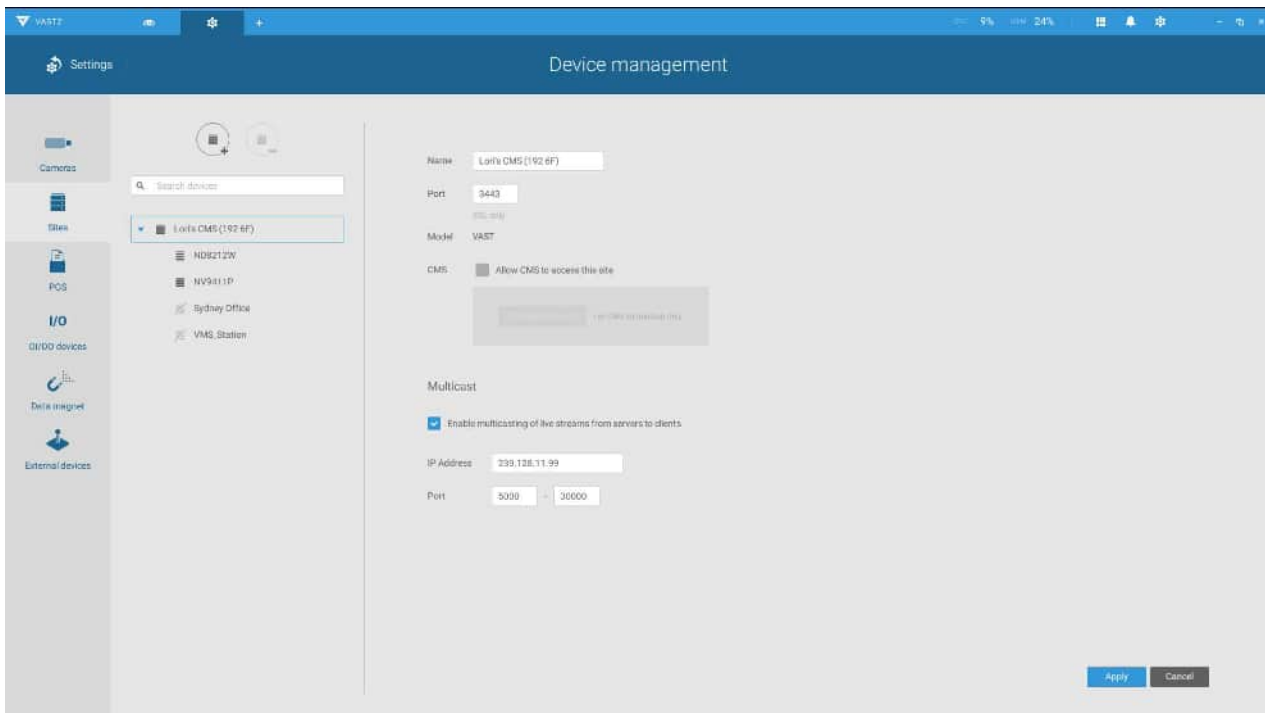

To enable Multicasting on a camera:

1. Enter Settings > Device > Cameras.
2. Single-click to select a camera for which you want to enable the Multicasting.
3. Click to select the Multicast tab.
4. Click the Multicasting slide button.
5. Click the **Apply** button.

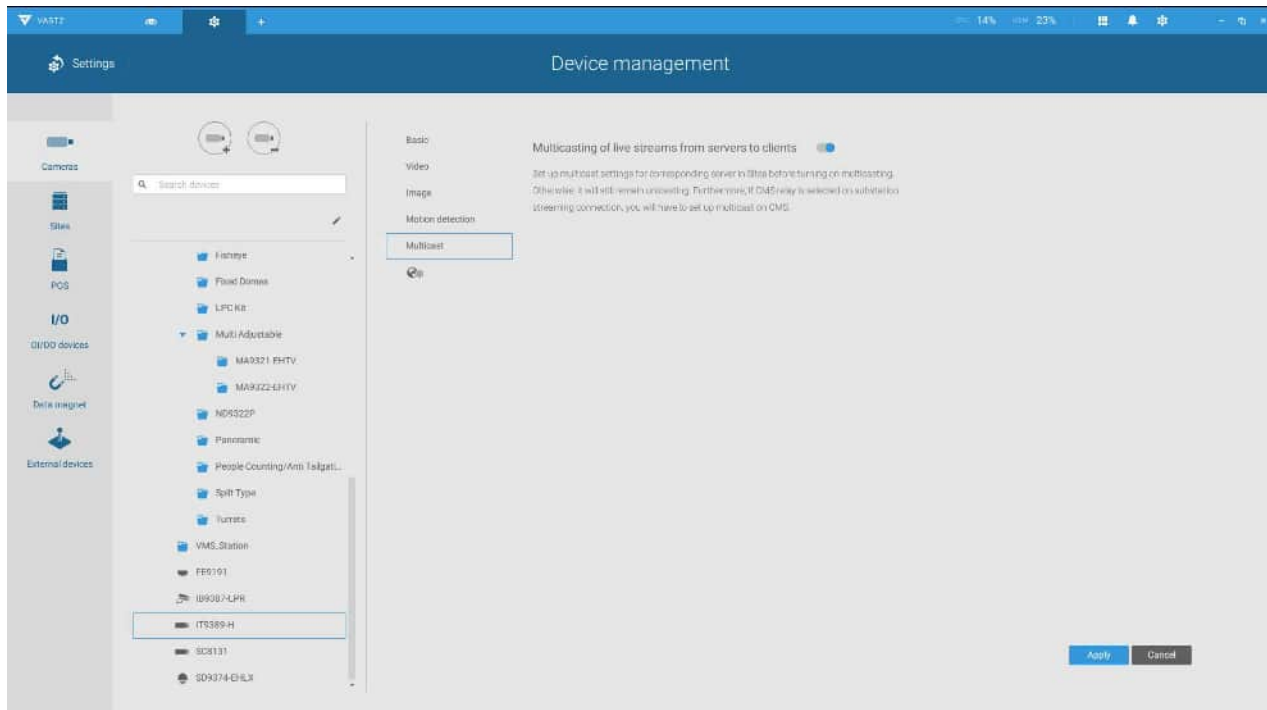

4-7. Settings > Device > POS

To connect a POS machine, make sure the POS machine is connected to the local network. Click on the Add POS  button.

1. Enter a device name, such as POS on the 1st floor counter.
2. Select the POS brand name. Currently VAST2 supports Lafresh, POSNET, Gulfcoast(POS Gateway).
3. Enter the IP address assigned to the machine.
4. Enter the TCP port number utilized by the POS machine for network connection
5. Select a related camera whose video feed will be used to display POS transaction data. This is the camera which covers the customers and cashier.
6. Enter specific item name or a total amount exceeding a high threshold, such as using >100 as a threshold. You can enter multiple highlight conditions using the add button below. The highlighted entries will be displayed in bright font colors on screen.

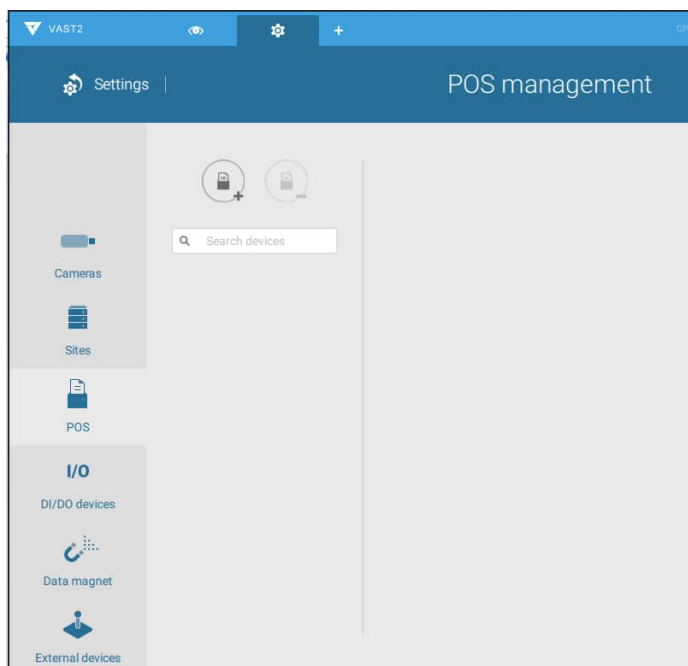
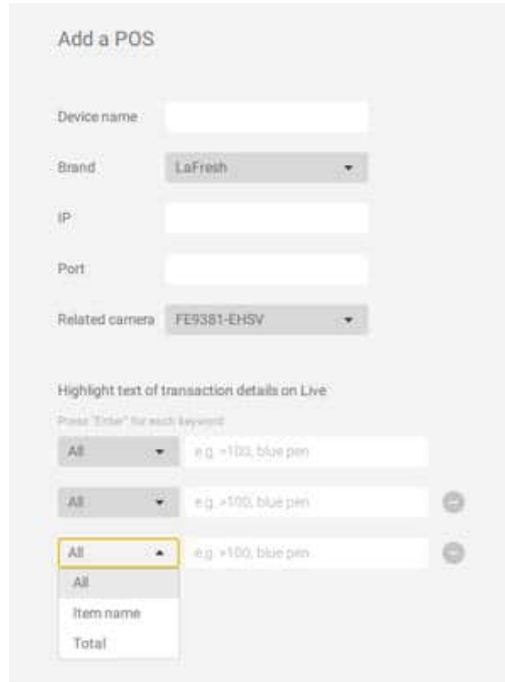



4-8. Settings > Device > Local DB

Since some of VIVOTEK's NVRs runs on Linux, you have to install the Ext2 File System Driver for Windows to access the recording files from a NVR hard disk.

The file system driver can be found here: https://sourceforge.net/projects/ext2fsd/?source=typ_redirect

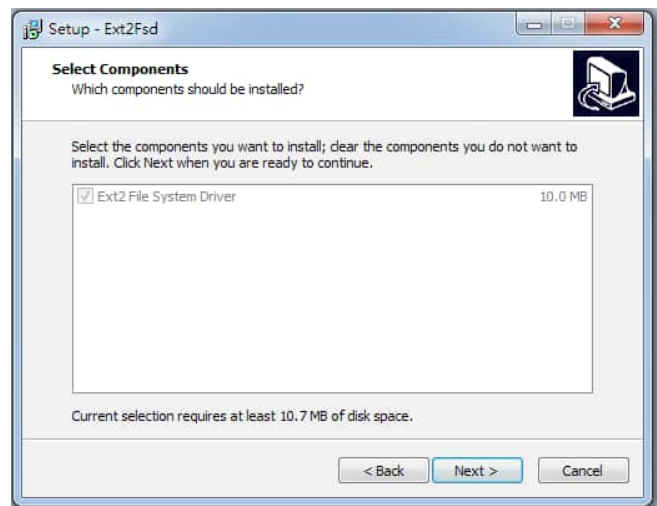
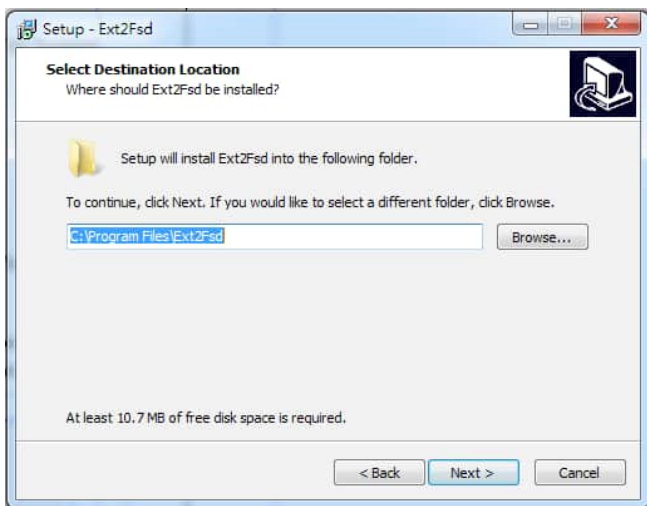
Run and install the Ext2fsd-0.xx.exe. Follow the onscreen instructions to complete the installation.



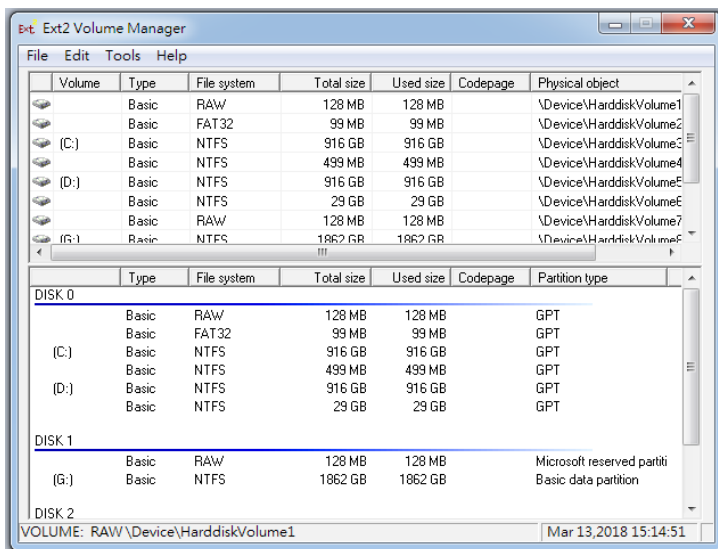
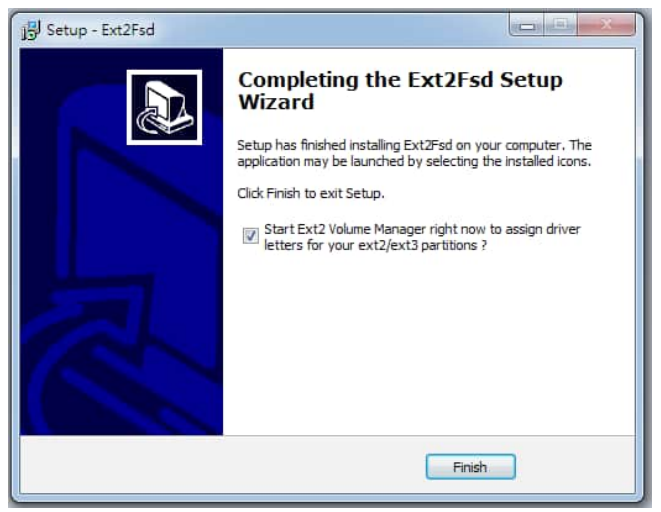
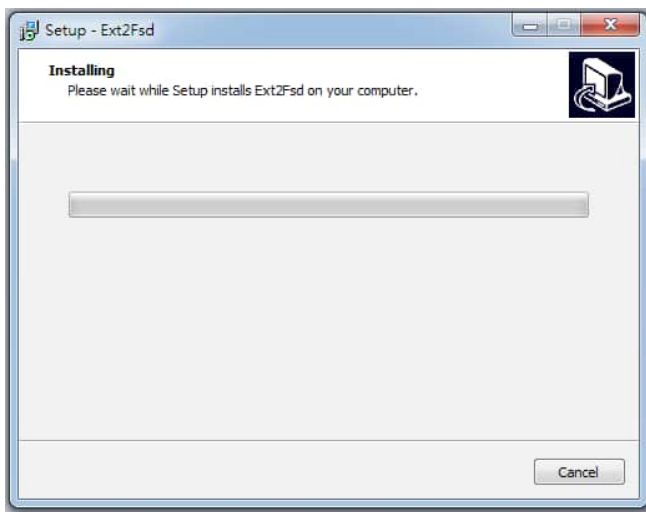
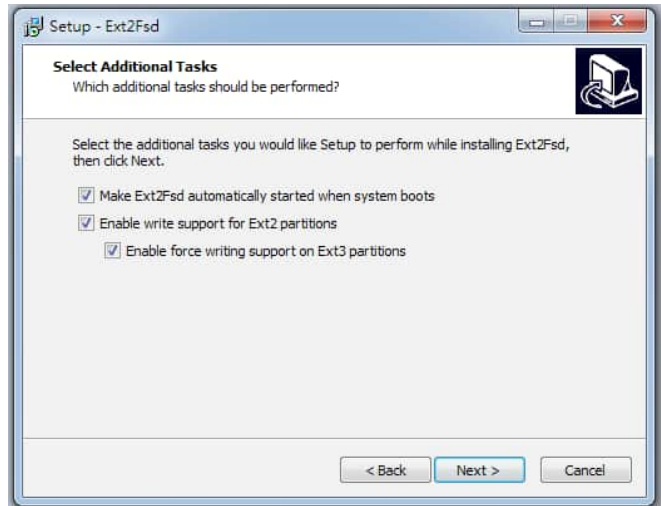
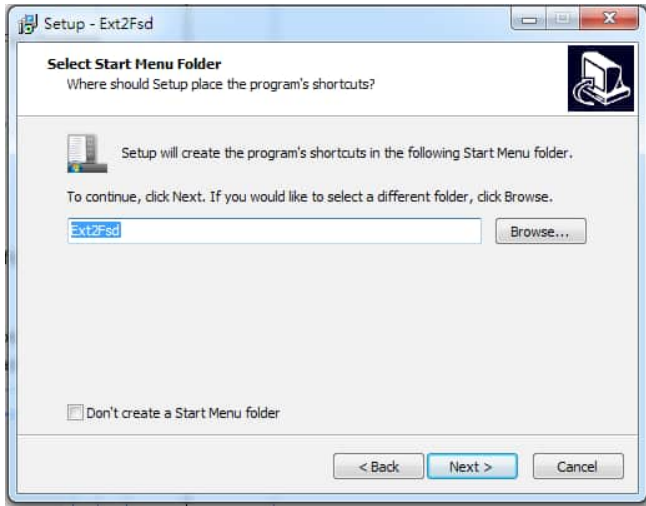

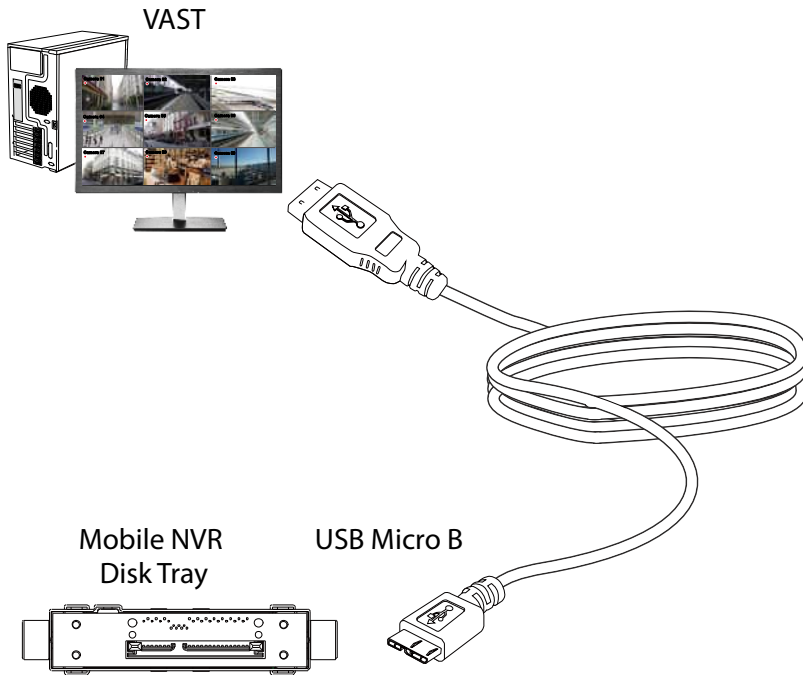

1. Remove the disk tray box from a mobile NVR.
2. Connect the disk tray box to your VAST server using a USB 3.0 type A to Micro B cable.

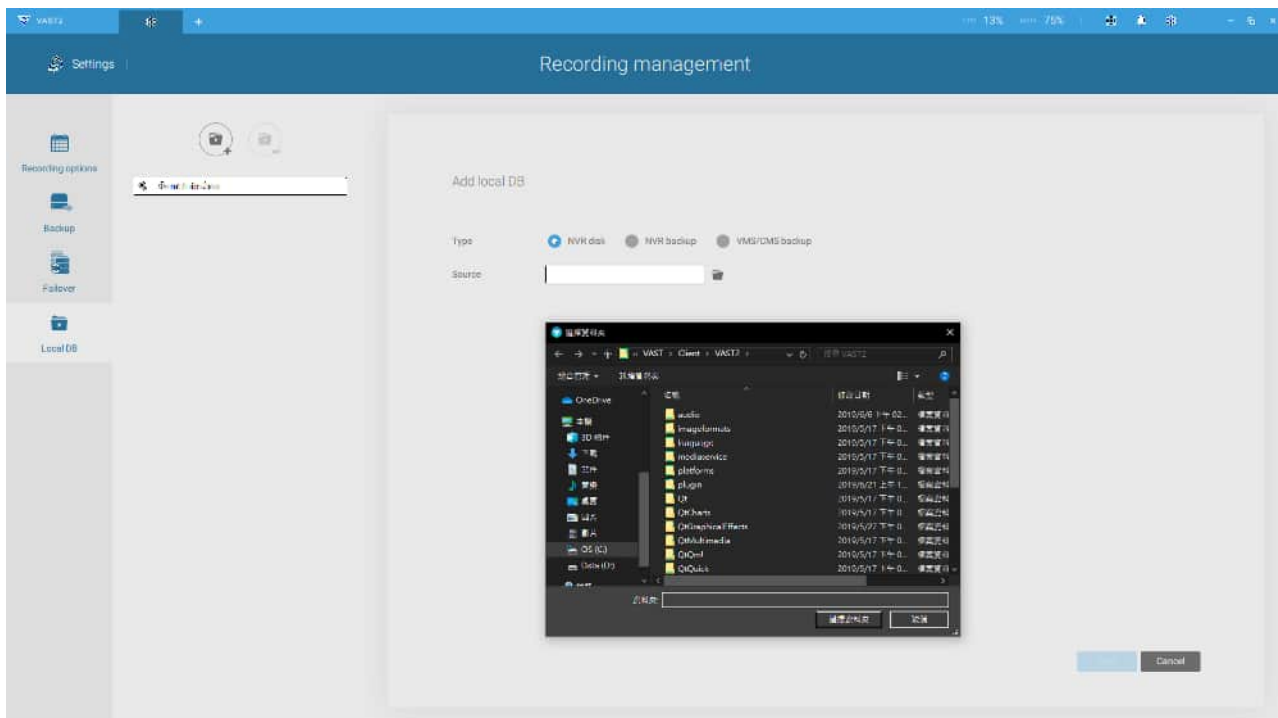

3. From VAST, enter **Settings > Device > Local DB**.
4. There are 3 import types:
 1. **NVR disk**: the drive tray box removed from a mobile NVR.
 2. **NVR backup**: the recorded videos exported from an NVR using a USB thumb disk or portable drive.
 3. **VAST backup**: scheduled backup from the local machine. They include: VAST backups from previous software releases, and scheduled backups.



5. Taking a mobile NVR's disk drive as an example, click the  Source select button to locate the disk drive.

6. The NVR will be mounted as a local DB.

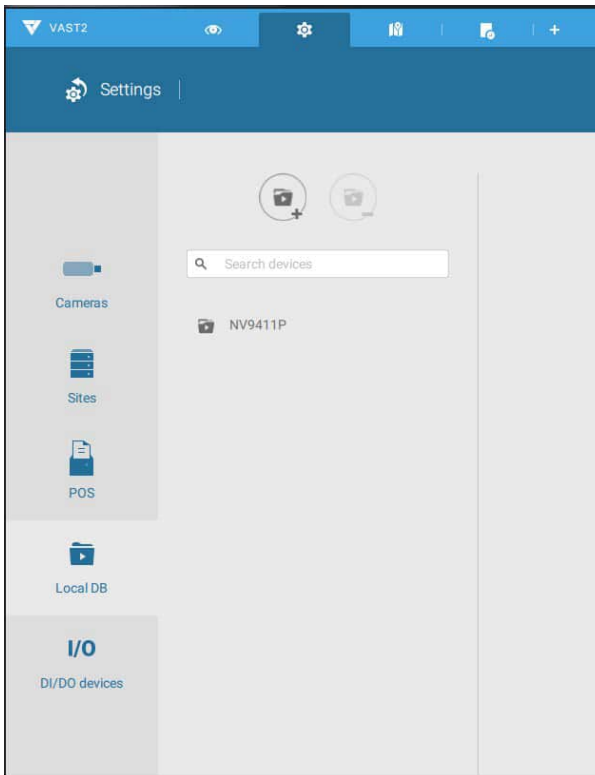

7. A Local DB sub-tree will be listed under your server, and you can view the existing recordings on the NVR's disk drive.

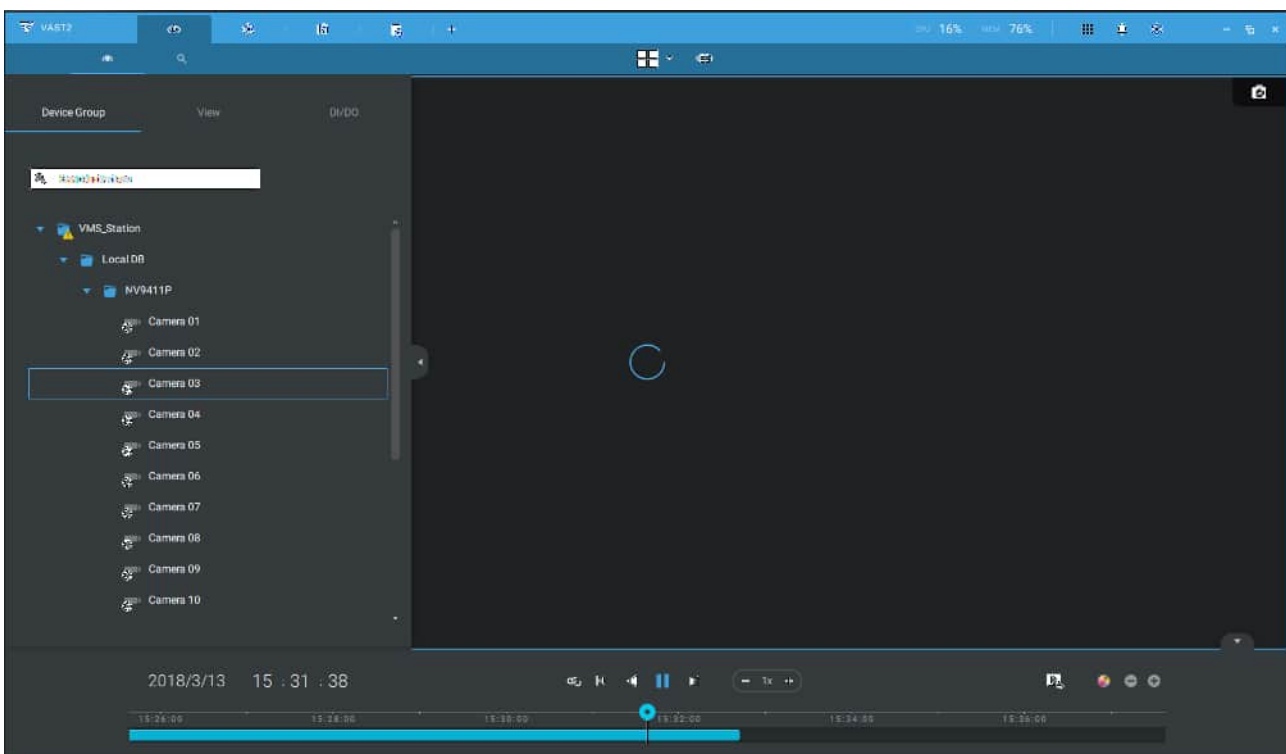

4-9. Settings > System > SMTP

Configure a mail server via which the system alarms or notifications can be delivered to a receiver.



Enter the Settings page, select . Click on the Add SMTP button.

Enter your mail server's domain name or IP address. Enter credentials for access to the mail service.

If SSL encrypted transmission is preferred, select its checkbox.

Click Add to complete the configuration.

4-10. Settings > IO Box and Related Configuration

Please refer to page 175 for information.

4-11. Settings > User Management

The User Add & Delete page allows you to create users with the permissions for different operational capabilities.

To specify the authorized privileges, select Customize in the Role menu, then select the Permissions and/or the Accessible devices tabbed menus.

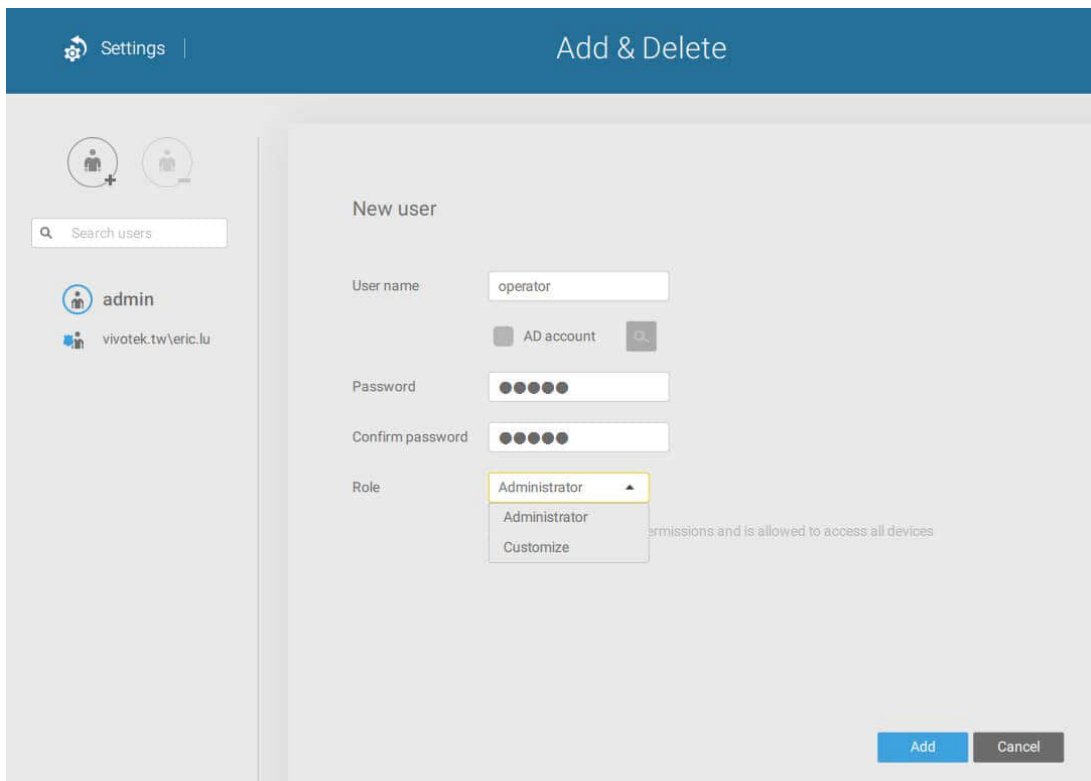

Use the Customize option to limit the authorized actions of a user.

In the Permissions tab, click the expand button  to unfold the Operation and Configuration menus. Select or deselect the checkboxes to configure the user privileges. For example, you may not want a user to operate Alarm and E-Map. If so, deselect these checkboxes.

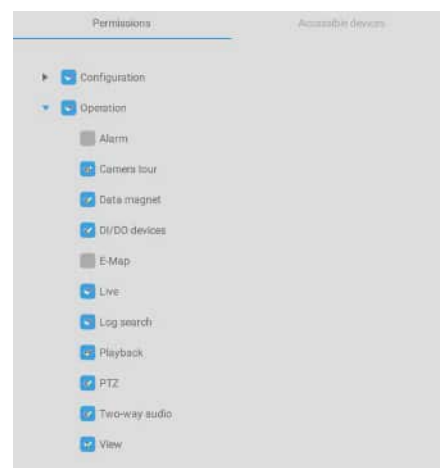

In the Accessible devices tab, click to select the cameras that a user can access. Some users may only need to access specific devices.

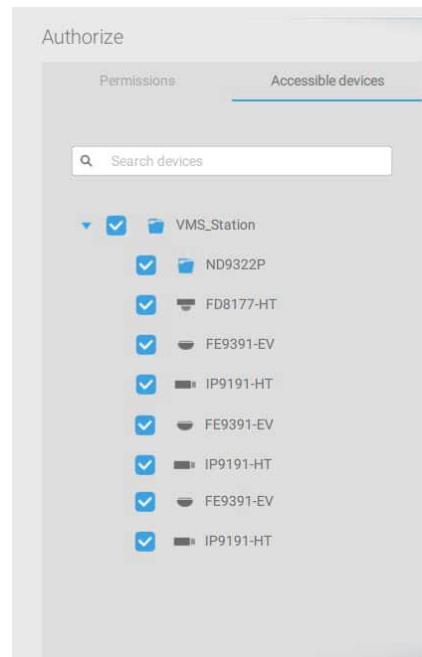

When done with the privilege settings, click Add to create a new user.

The new users will be listed under the Administrator's icon. Repeat the process to create more users.

Add a New User Account - Windows AD Account

In an established, enterprise network environment, the support for Windows AD (Active Directory) infrastructure enables ease of integration using the credentials of existing users. Using the same AD authentication methodologies, you can configure the clients or users in an established network to access the VAST server configuration.

Note the following with Windows AD support:

1. If you install VAST server on a Windows XP machine with Postqre SQL server, the login using a Windows AD account will not work.
2. The VAST server must reside in a domain managed by the AD server.
3. This function does not support the environment that spans across multiple AD domains.
4. A user account hosted by an AD server cannot be modified in VAST.
5. A User Group and its members configured in AD cannot be managed in VAST.
6. You cannot add an account having the same name as one you used to log in VAST.
7. There are 3 types of account for VAST: VIVOTEK account, AD single user, AD group.

To add an existing AD user,

1. Select the AD account checkbox.

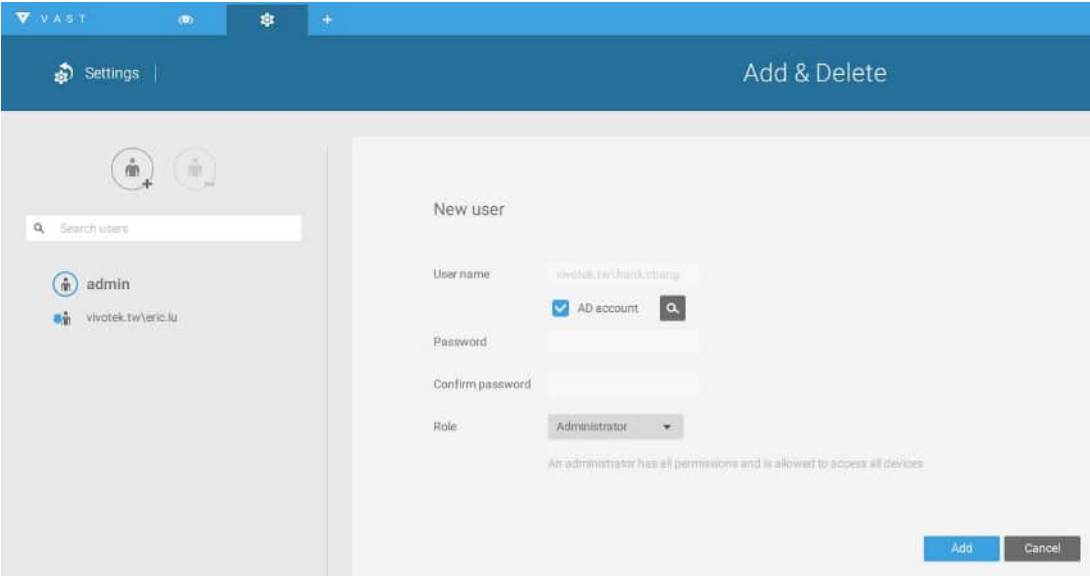

The screenshot shows the VAST user management interface. The top navigation bar includes 'Settings' and 'Add & Delete'. The main content area is titled 'New user' and contains the following fields:

- Username:** vivotek.tw\charn.chang
- Account Type:** AD account
- Password:** (empty field)
- Confirm password:** (empty field)
- Role:** Administrator (dropdown menu)

Below the role dropdown, a note states: "An administrator has all permissions and is allowed to access all devices". At the bottom right, there are 'Add' and 'Cancel' buttons. On the left side, there is a search bar labeled 'Search users' and a list of existing users: 'admin' and 'vivotek.tw\eric.lu'.

2. Click the Search  button.

3. Enter a user name or group name to search, e.g., Frank. Click OK when done.

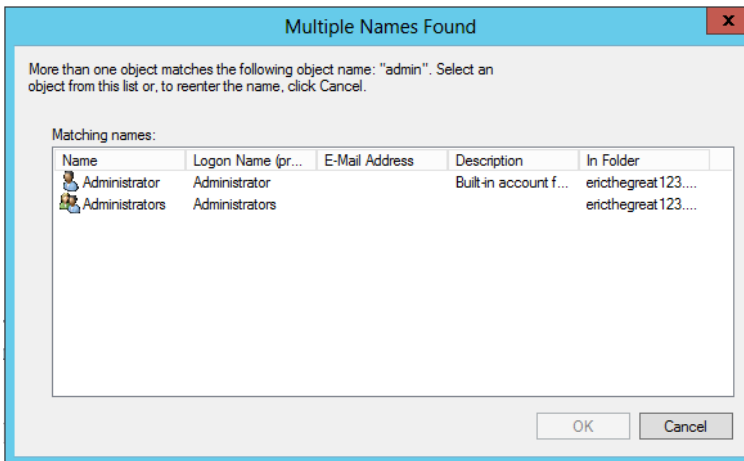
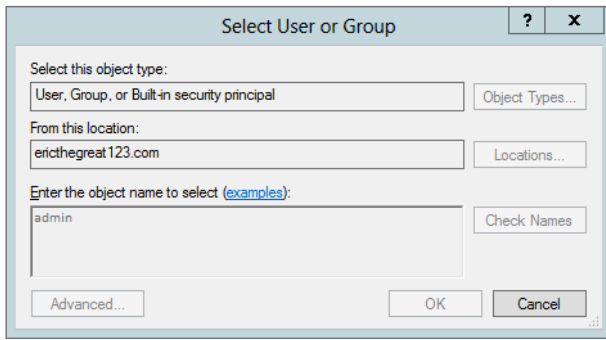

4. Enter the password twice for the AD user.

5. Select the privilege role for the user, configure his/her privilege settings as described above and then click Add.

Appendix A: VAST Service Control Tool

VAST service control tool is a tool for server control and for user to be aware of the VAST Server status. It starts up as Windows OS startup.

Under Microsoft Windows, choose "**Start > VIVOTEK Inc VAST > VMServiceControl.**"

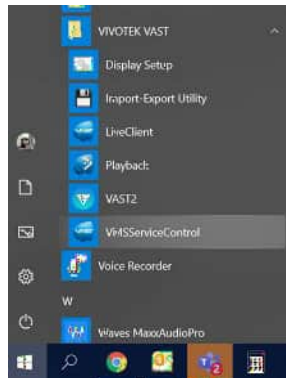

You may also find it in the system tray icon of the tool bar, which indicates that the service is running: 

It shows a disconnection icon when the service is stopped: 

A menu for the service control tool will pop up when you **right-click** on the icon:

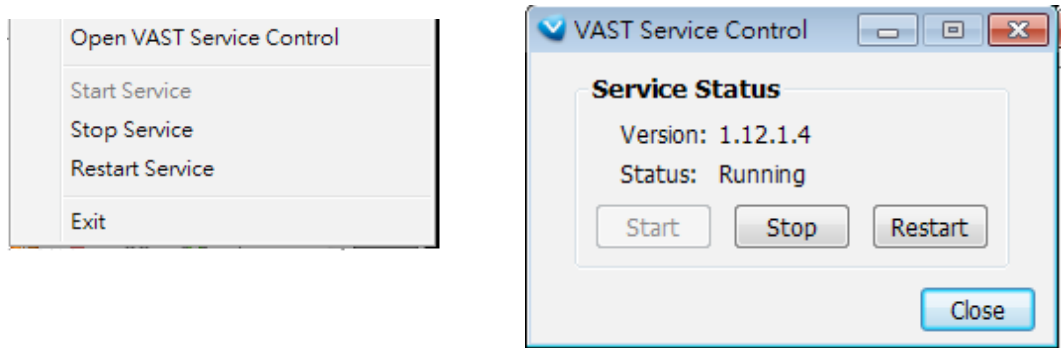

Here you can manually start, stop and restart the service.

Appendix B: Matrix

The virtual matrix feature enables the display of any cameras on any monitors in an IP surveillance network. Combinations of live or playback streams can be displayed simultaneously. In addition of pre-configured live views, E-maps, Google maps, and Alarm panes can all be placed on a remote matrix. Users gain realtime awareness of scenes and access to past events.

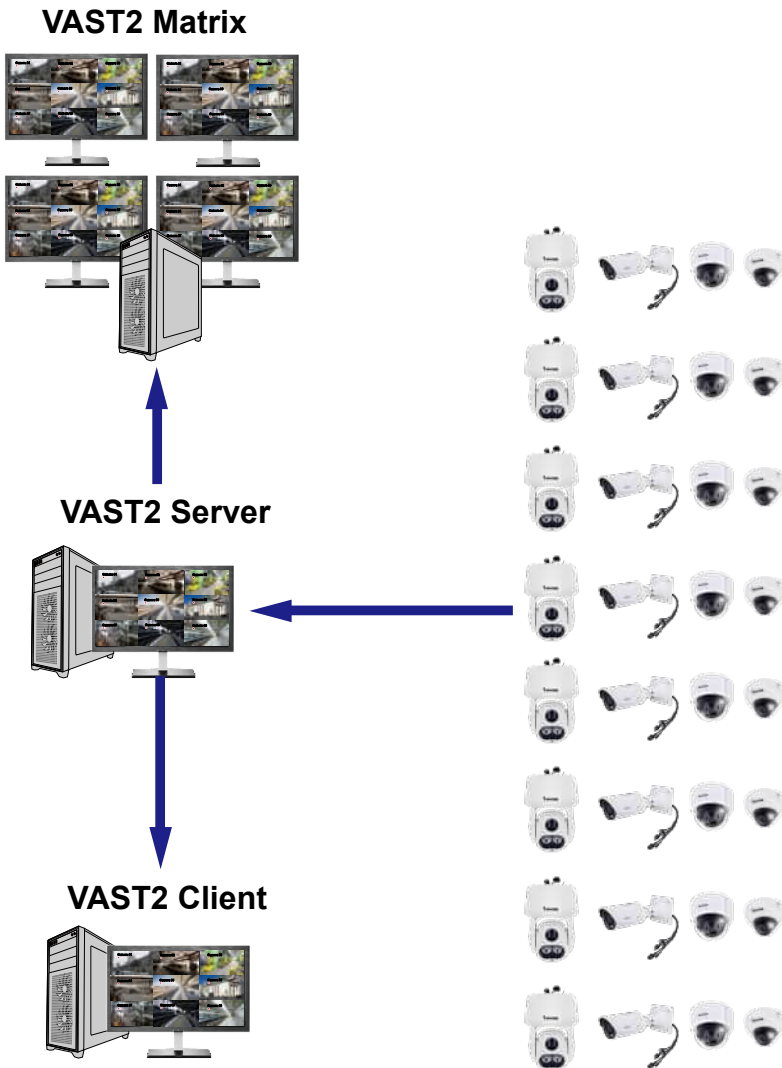

Prerequisites:

1. One VAST2 server and another computer running the Matrix client utility.
2. The first 2 digits of software revision numbers of VAST server and Matrix client must be the same: e.g., 2.3.x.x and 2.3.x.x.
3. Sufficient network bandwidth among network cameras, VAST servers, and Matrix clients.

Configuration procedure:

1. Install the Matrix client utility on a computer equipped with multiple monitors. Follow the onscreen instructions to install the utility.

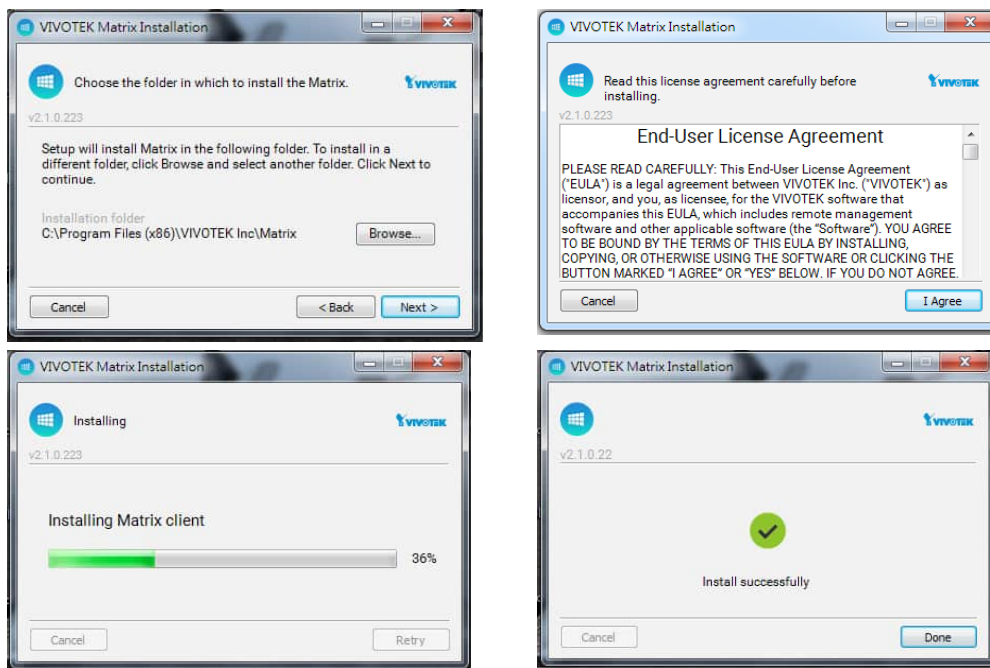

2. On the VAST server, create a user account for the Matrix client. Depending on the operation on the client computer, assign the client user with adequate operation privileges.

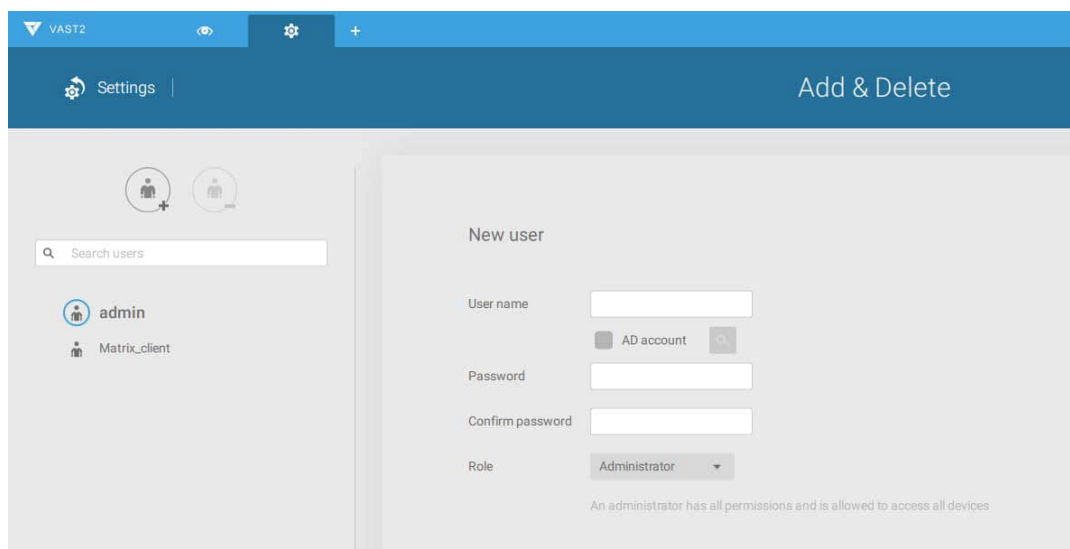

3. Open the Matrix utility, log in to the VAST server address, using the Matrix client account credentials.

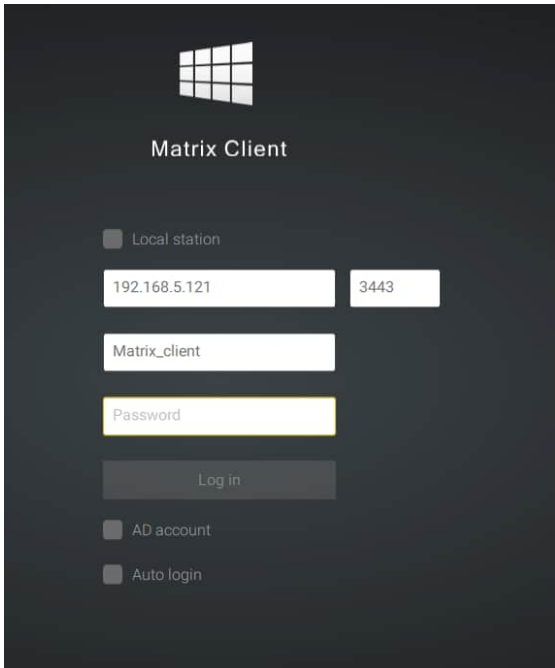

4. From the VAST server, open the Settings > Matrix Management window.

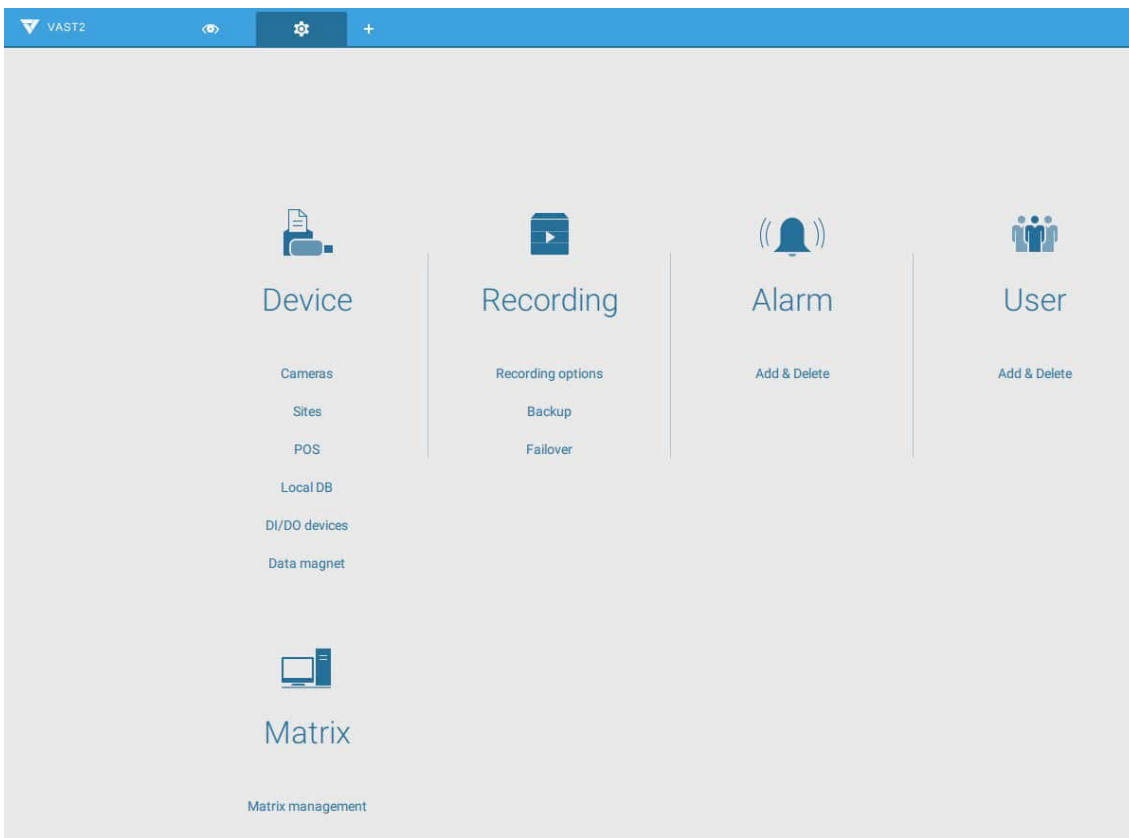

5. Enter the name of your Matrix client, e.g., Matrix_client in the search pane of the Matrix Management window. Note that the Matrix client must have logged in to establish the connection before the VAST server can find it (as previously described).

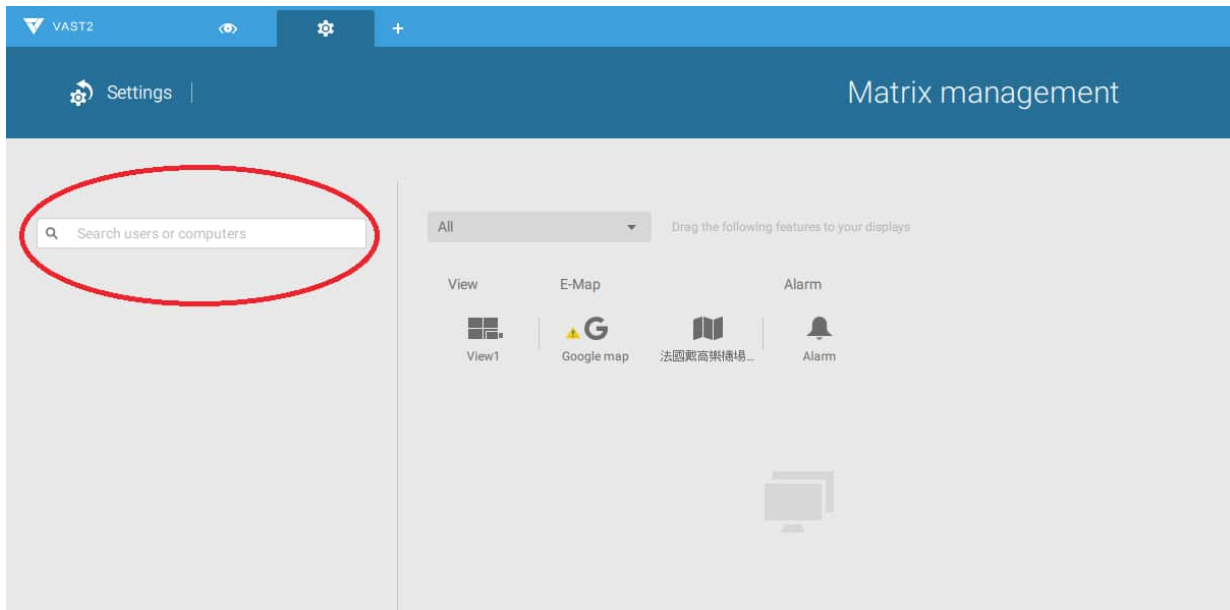

6. Once the VAST server found the Matrix client, the available monitors will be listed. Click and drag the pre-configured Views, Tour, Dashboard, E-maps, or Alarm panel to any of the monitors.

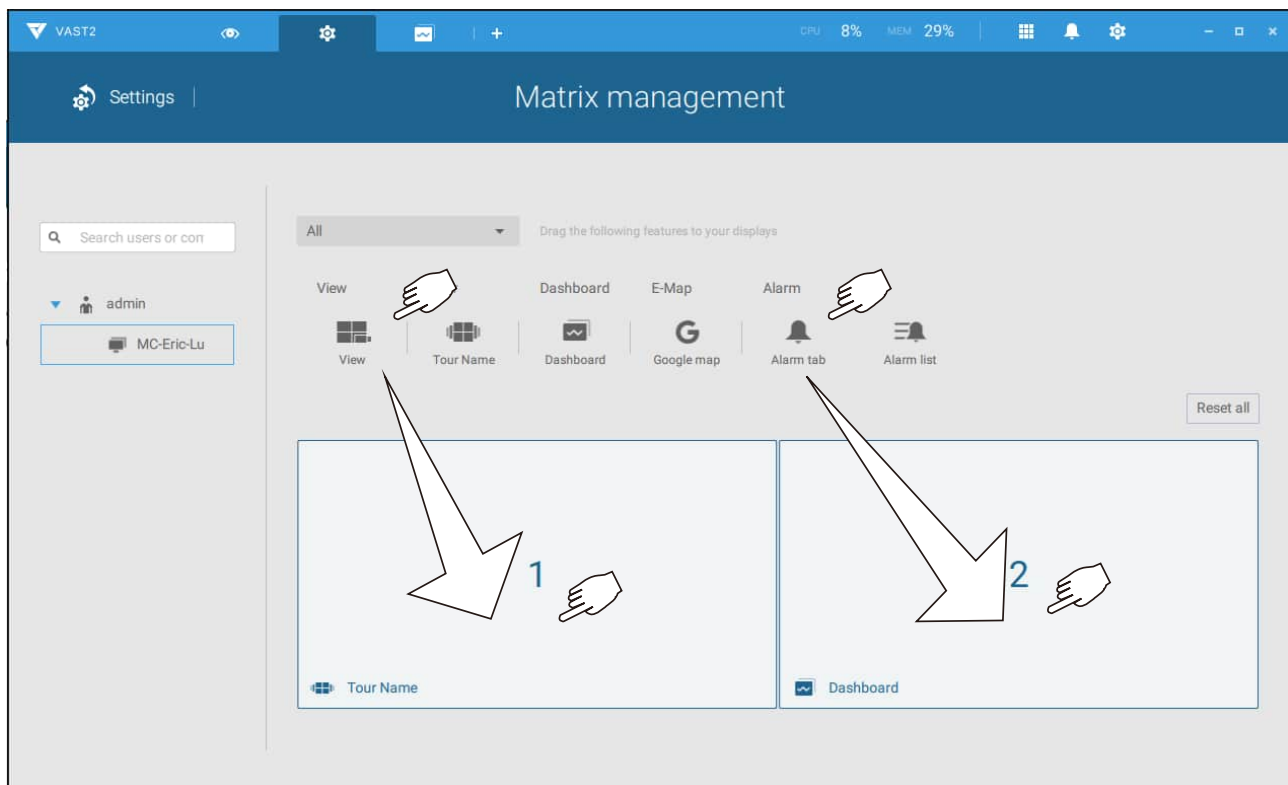

7. The views should immediately appear on the Matrix monitors.

8. If you need to log out, move your mouse cursor to the top of the Matrix client screen to end the session.

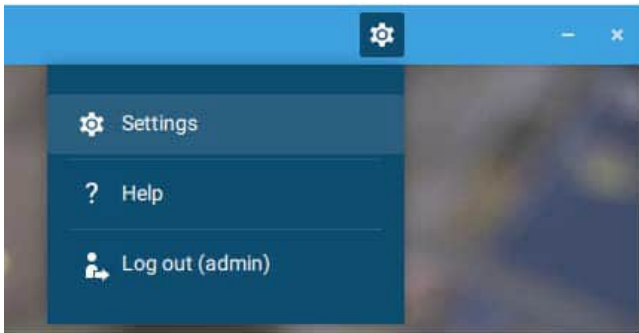

If necessary, change your client settings. Here you can change the displayed language, Export target folder, Start-up option, and the streaming connection options.

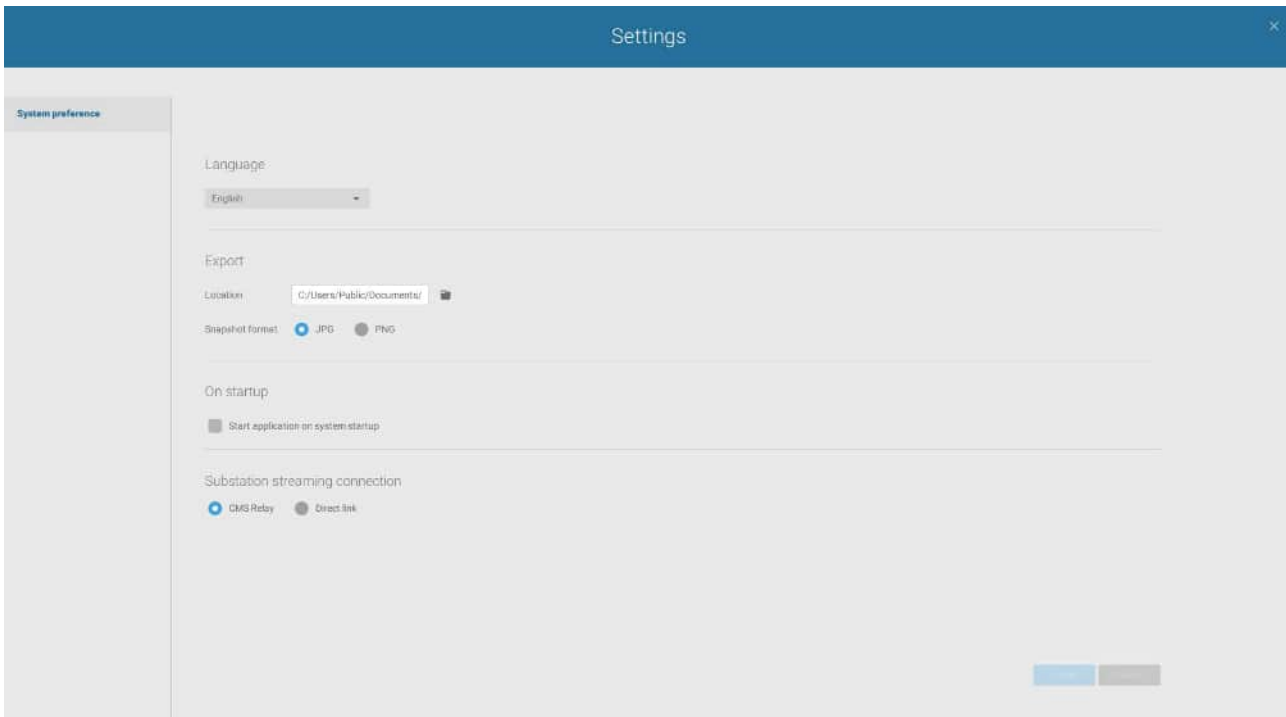

Appendix C: Joystick Support

Configurable joystick buttons

1. Connect the joystick's USB cable between the USB ports on the joystick and a VAST server/client.
2. Once connected, you should be prompted by a connection message.

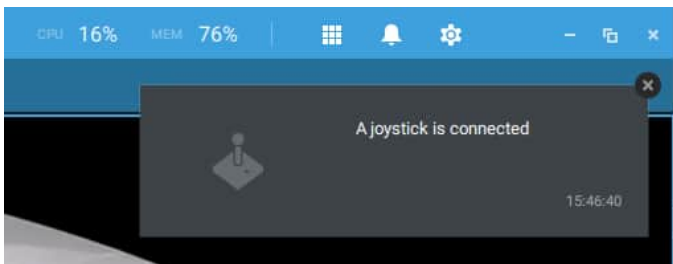

3. Enter **Settings > Device > External devices**.
4. Single-click to select the detected joystick. The configurable buttons will be listed. Click  to expand the **Live, Playback** and **Common** menus.

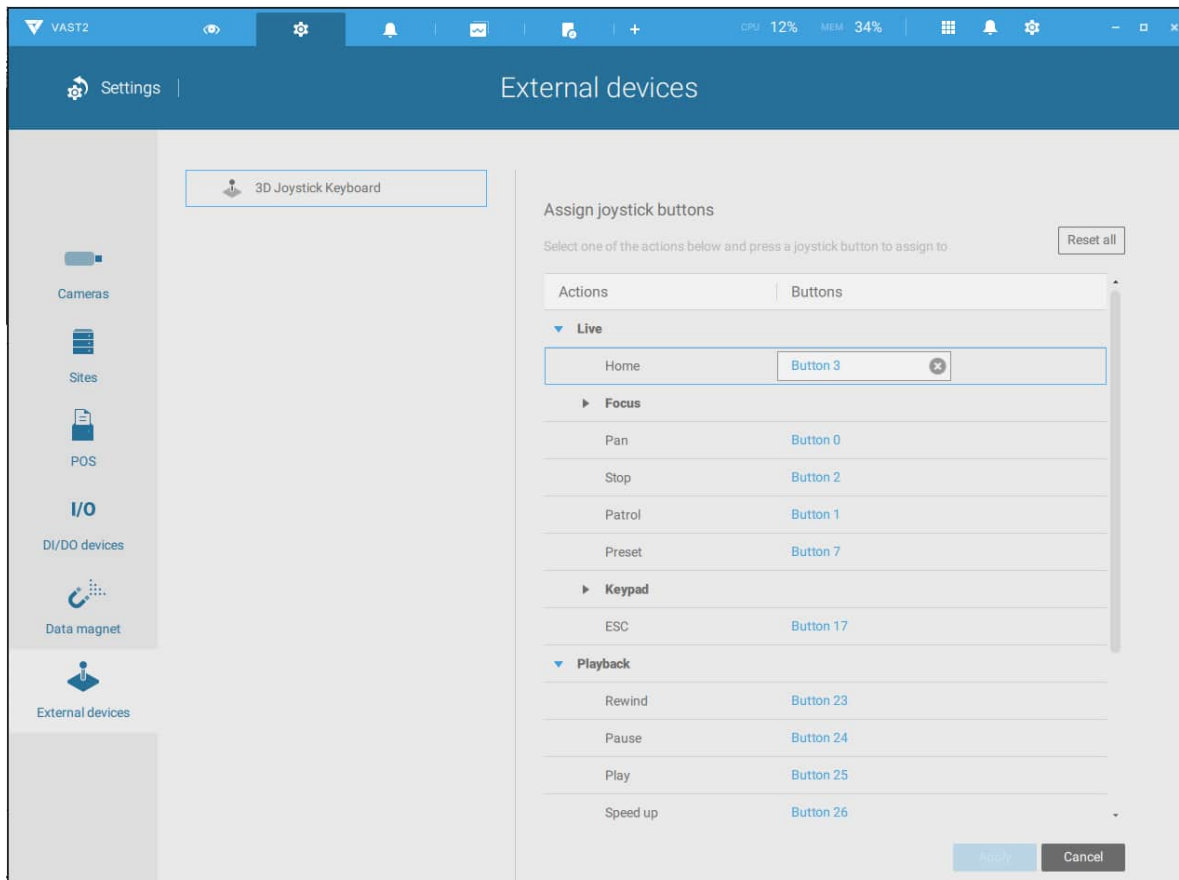

5. To assign or re-assign a button's function, single-click on the button number besides a function. Click the Delete  button. The below message will display.

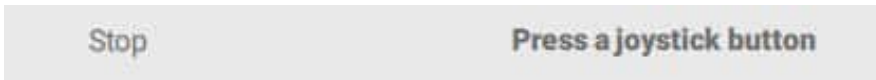

Press a preferred button on your joystick to complete the setting.

If a button conflict occurs, (another function has already been assigned to the same button), the below message will prompt. You can Cancel or click Apply to change the assignment.

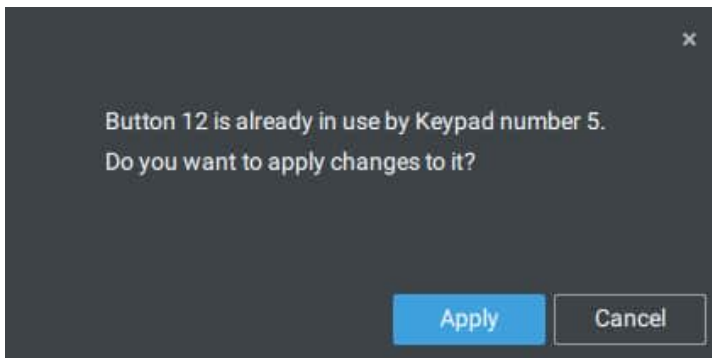

Repeat the above process and click the **Apply** button to preserve your settings.

VIVOTEK's joysticks

The AJ-002 is a USB joystick with HID 3-axis PTZ control, a twist wheel for zoom in/zoom out, and 29 configurable function buttons for use on a VAST server station.

Following are the conditions for making the connection:

1. The joystick can either be powered by a DC 12V adaptor or via the USB. If powered by USB, plug the USB cable twice to the USB port to enable USB power.
2. Connect the included USB cable between the USB ports on the joystick and a VAST server.

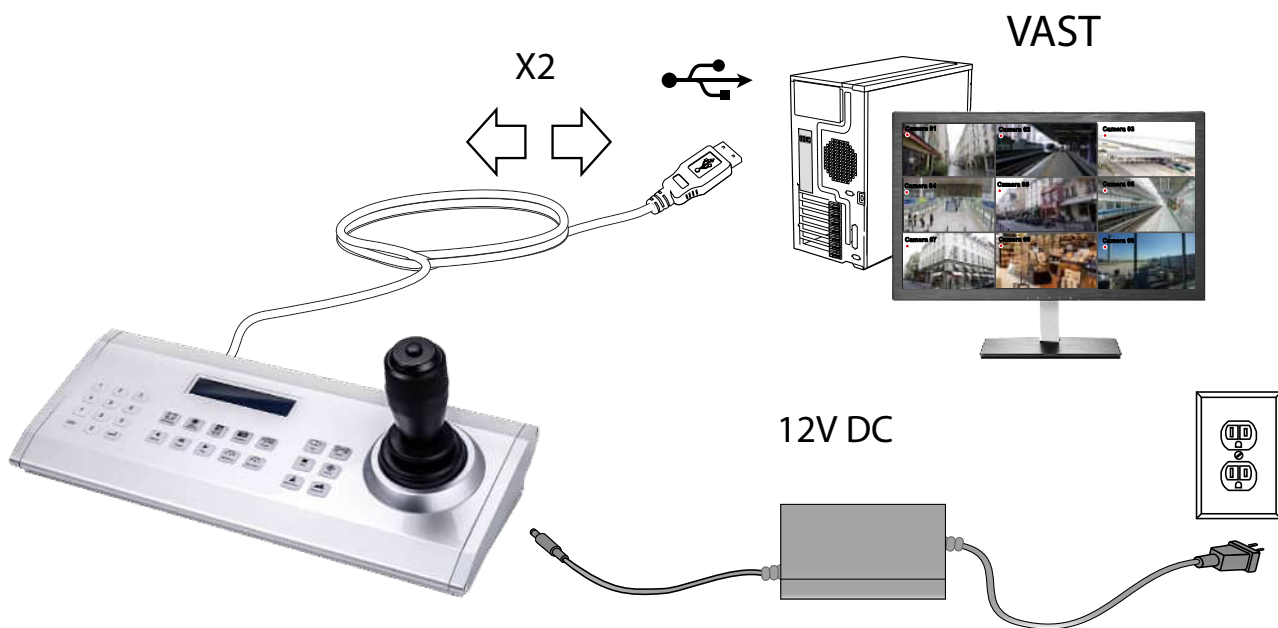

NOTE:

1. Avoid spilling water onto the device. Avoid using this device in a high-moisture environment.
2. This device should be operated in the indoor environment.
3. When the temperature is lower than -10°C , the LCD panel may not function normally.
4. If the included power adapter should be replaced, use a 9-15V/1000mA alternative.
5. Avoid impact to the device.
6. This product is manufactured to comply with the requirements of the following directives: 89/336/EEC, 92/31/EEC, 93/68/EEC.

KEYPAD DEFINITION

Below is the keypad numbering sequence:

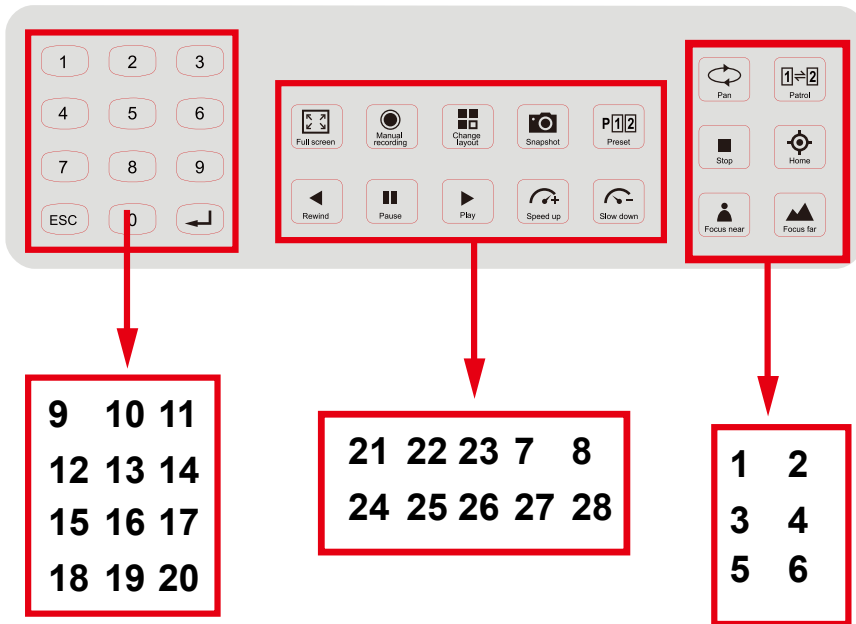

The following keypad functions will be available as the defaults for the joystick.

1	Pan	9	#1	17	#9	25	Pause
2	Patrol	10	#2	18	Cancel/Clear/Esc	26	Play (Playback)
3	Stop	11	#3	19	#0	27	Speed Up
4	Home	12	#4	20	Enter	28	Speed Down
5	Focus Near	13	#5	21	Full Screen		
6	Focus Far	14	#6	22	Manual recording		
7	Snapshot	15	#7	23	Change Layout		
8	Preset	16	#8	24	Rewind		

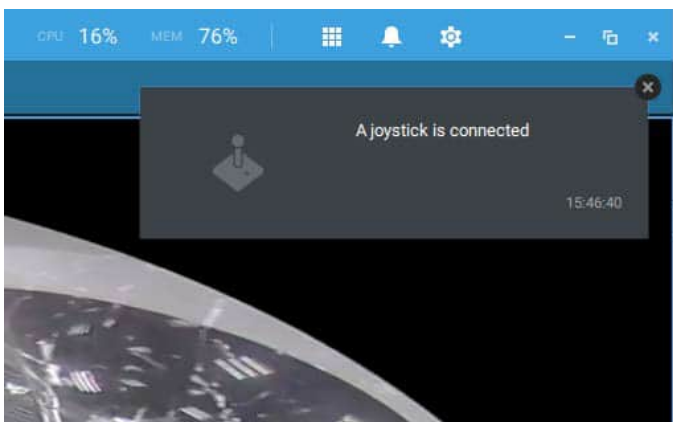

When a joystick is connected, the VAST server should automatically detect the connection.



The following controls are available:

- * PTZ control – Basic PTZ control: Direction, Home, Zoom in/out, and Focus near/far.
- * Playback control – Play, Pause, Stop, Rewind, Speed up and Slow down.
- * View switch – Switch to existing View (Users need to create views first).

Left-click to select your server on the device tree, and right-click to display and select the "**Show joystick key number.**" The camera key numbers are determined by the sequence when the cameras were added to the VAST configuration, and cannot be changed. By default, the key numbers are not shown.

Press the key number on the joystick keypad and the Enter key , e.g., 5 + . The full view of the selected camera will display.

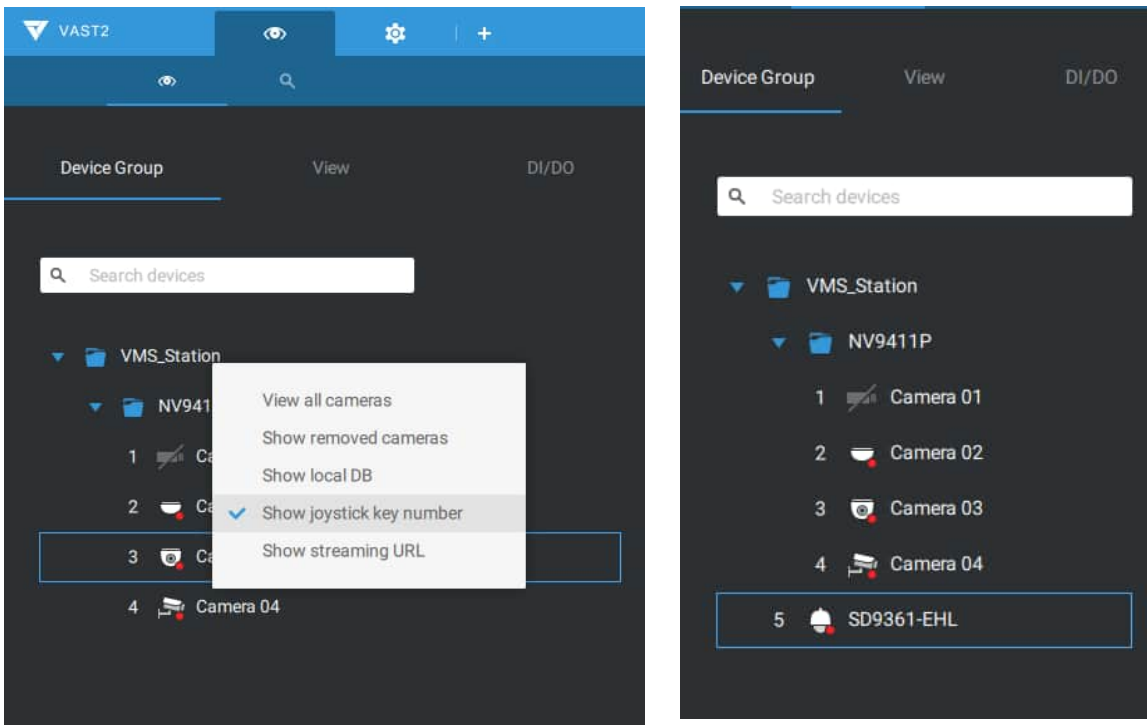

Press the ESC key to leave the full view.

To move to a preset position, press the number key + Preset, and the Enter key . The number key corresponds to the sequence number for the preset position regardless of the name of the preset.

Note that the RS232/485 terminal connection is currently not supported.

Note that the Manual Recording button is currently not effective.

If you have multiple views, press the number key and the Change Layout, and the Enter key  to switch to a different view. The number key corresponds to the sequence number for the view you configured regardless of the name of the view (layout).

The Play button toggles the playback window. From here you can trace back the past recordings. You can use speed up, slow down, and rewind buttons here. Once the Playback mode is toggled, the point-in-time defaults to the start of the current hour.

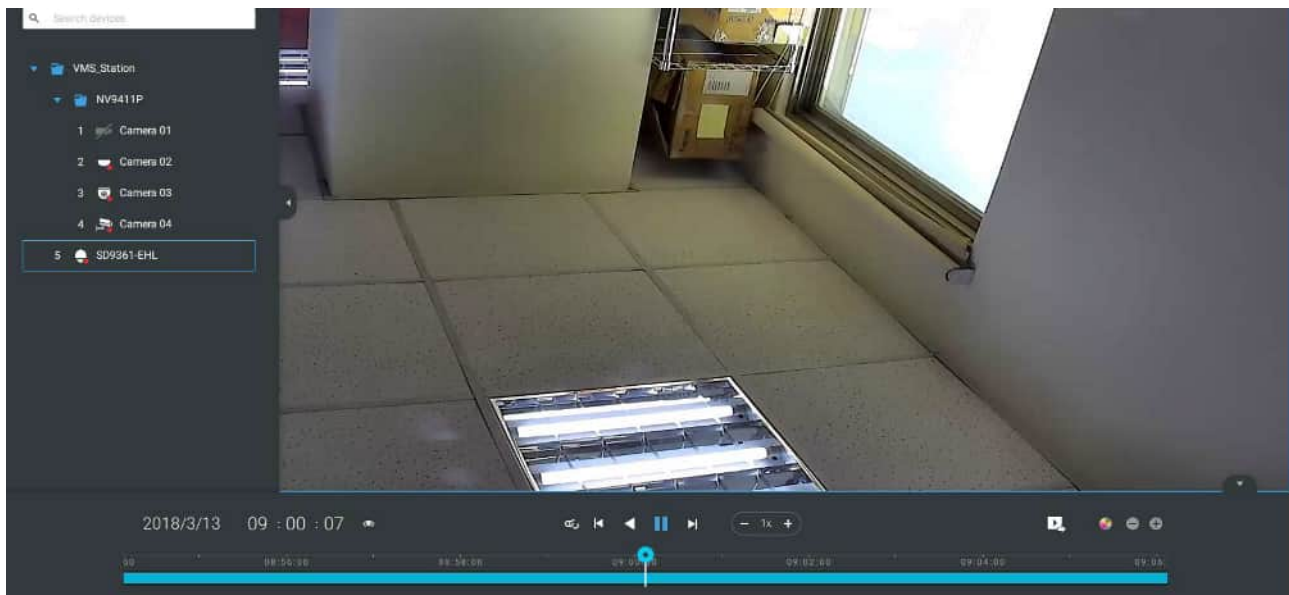

Appendix D: Upload Device Pack

A device pack is constantly updated for the latest profiles of VIVOTEK's new camera/NVR models. If you install new cameras/NVRs to your configuration, you can visit VIVOTEK's website for the latest device pack updates, and upload the pack file to your VAST server. New functional parameters and functions in the new cameras are available through the device pack.

Enter Settings > About to see the upload button.

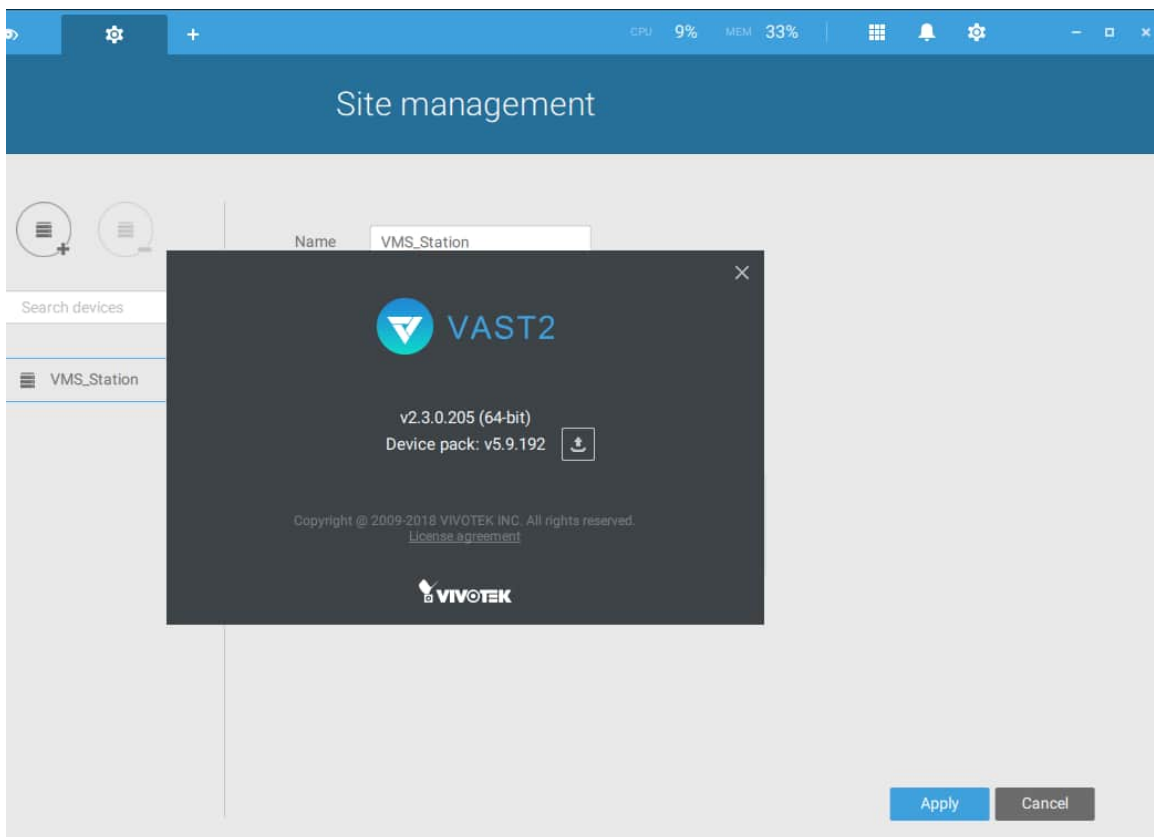

A device pack file looks like the following.

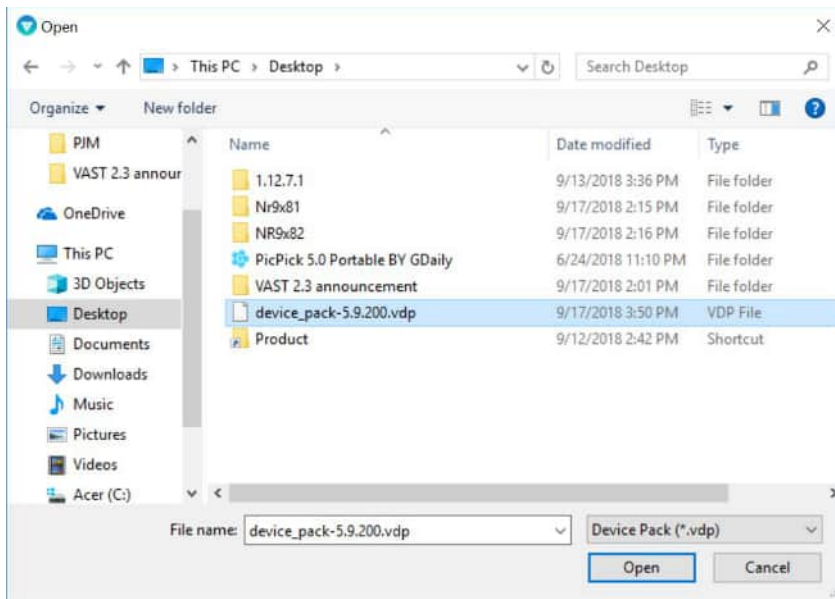

Appendix E: Using LPR Related Functions w/ Data Magnet

Acquiring data sources from 3rd-party software:

1. Select a camera that comes with the LPR (License Plate Recognition) functionality, e.g., IB9387-LPR as shown below. Click "More settings on Web" to open a web console to the camera.

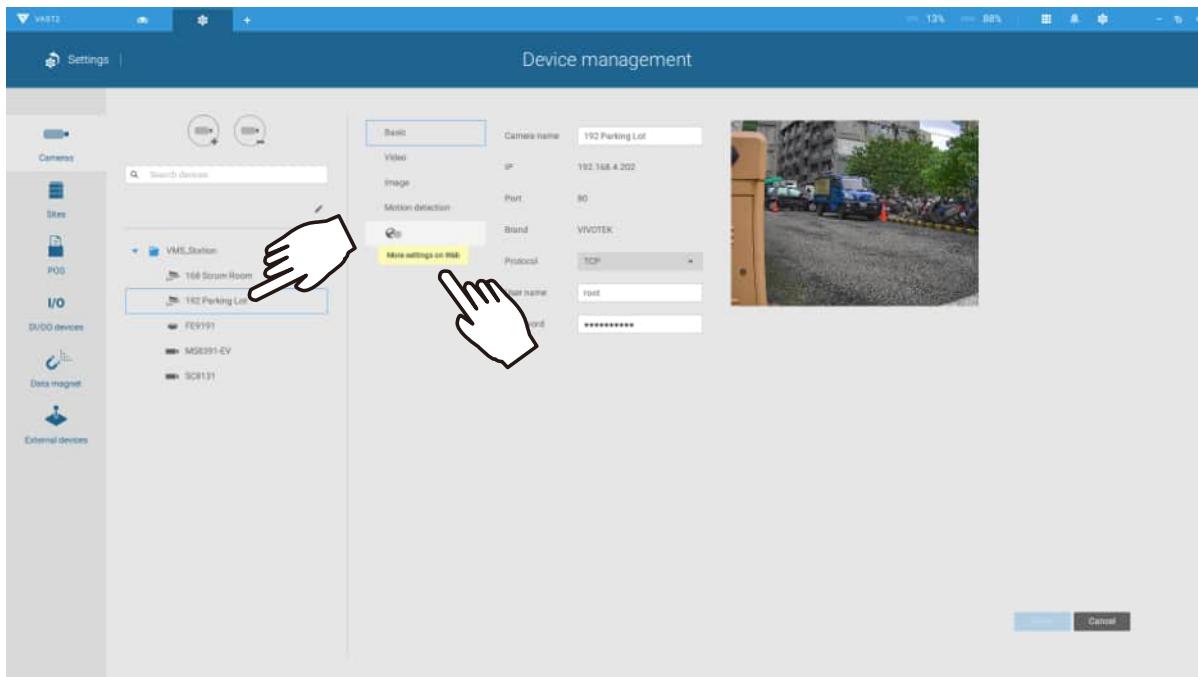

4. Select a list whose data will be transmitted to the VAST server.

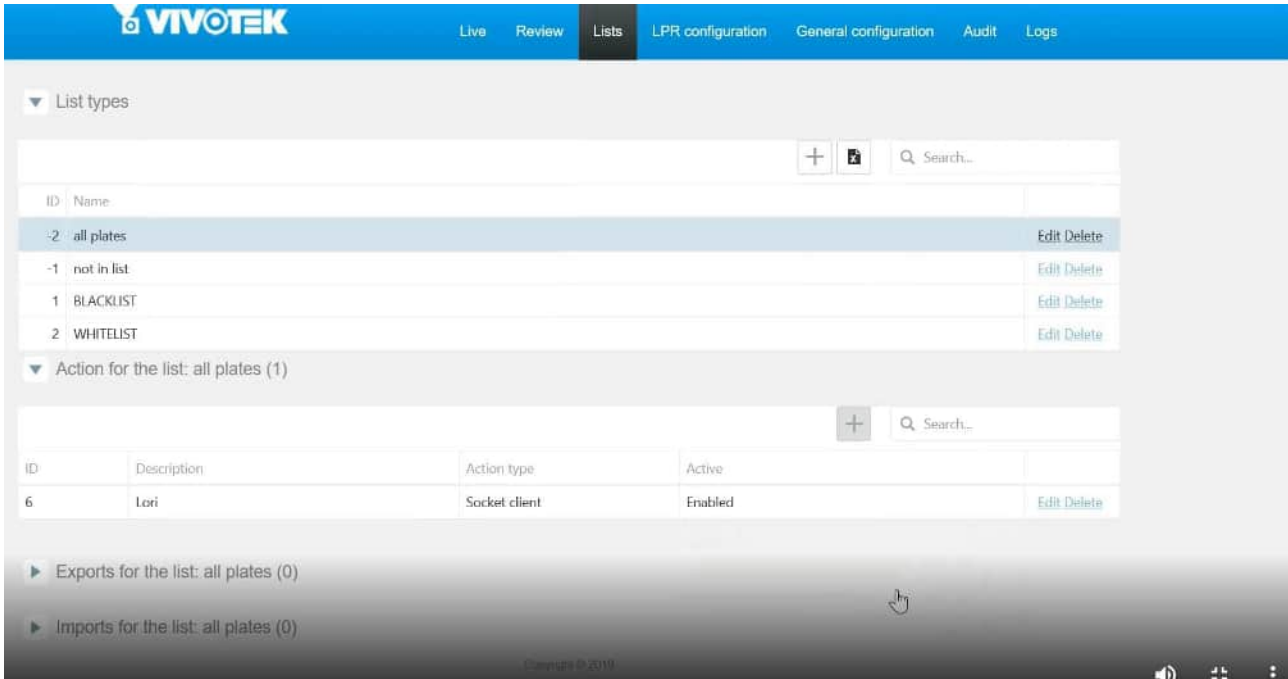

- 5. 5-1. Find the "Action for the list" pane. Click the "+" **Add a row** button.
- 5-2. Enter a short description for the row.
- 5-3. Select **"Socket client"** as the action type.
- 5-4. Click to select **Enabled**.
- 5-5. Click the **Save** button.

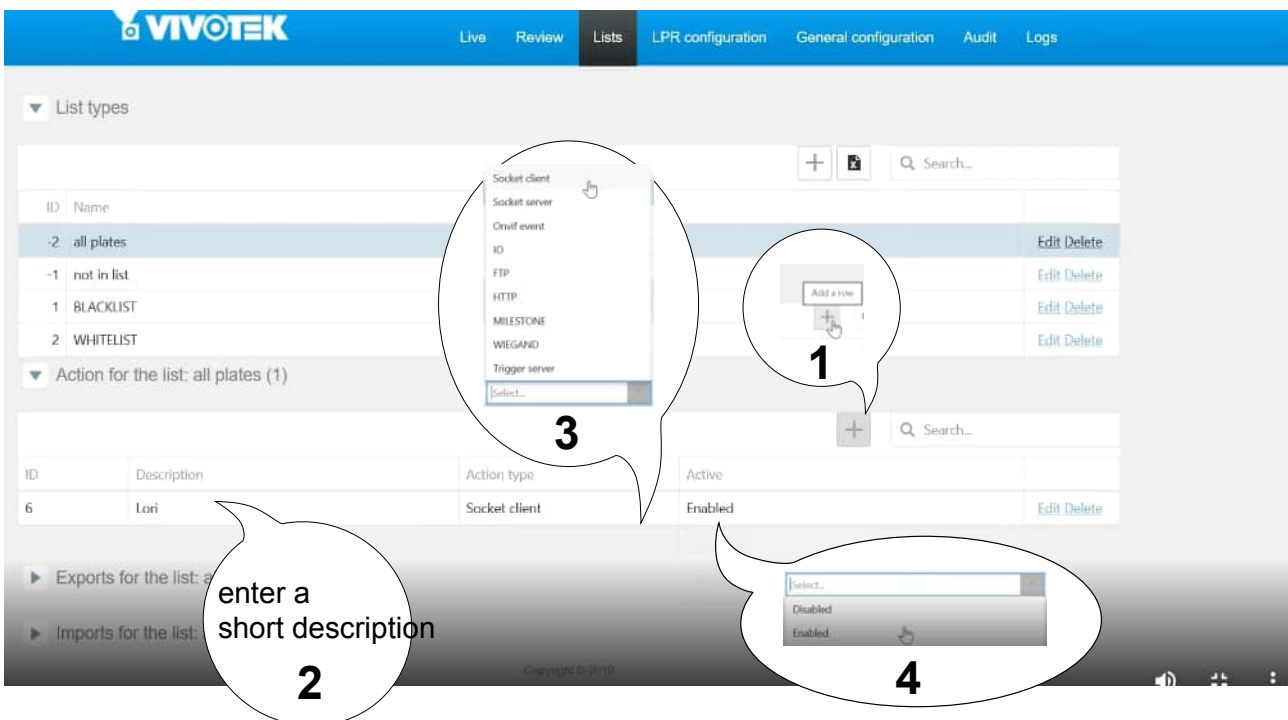

6. Roll down to enter your VAST server's IP address. If necessary, select **XML_IMG** as the file format for your data that will be collected on VAST.

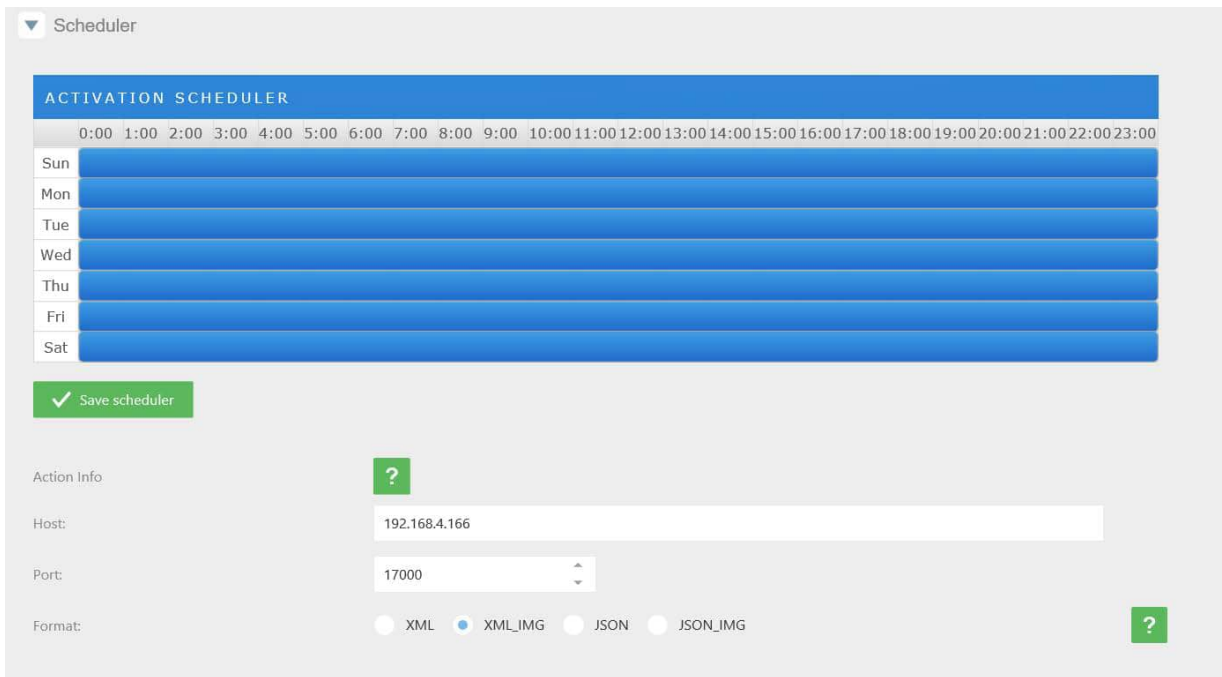

7. Close the web console and return to the VAST **Settings > Device management > Data magnet** page.

Click the **Add** button, and click the **License Plate Recognition** button.

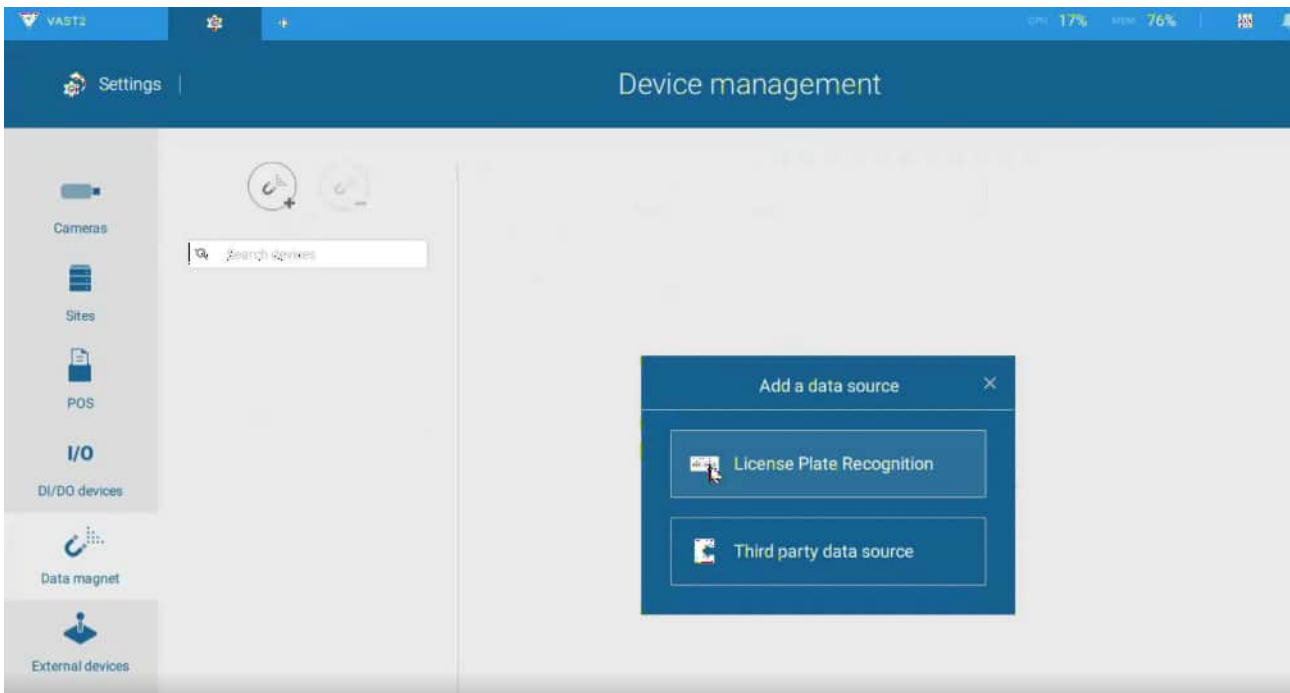

NOTE:

1. The License Plate Recognition data source will not be charged with a Data Magnet license fee.
2. The VAST server port for License Plate Recognition data source can be customized; It is not limited to 17000.
3. If you have more than one VIVOTEK LPR camera, you only need to (and can only) add a License Plate Recognition data source.
4. If you add a 3rd-party data source but you name it as "VIVOTEK ANPR", it will be recognized as a VIVOTEK ANPR (License Plate Recognition) data source.
5. Different Data sources cannot have the same name.
6. Different 3rd-party data sources can share the same server port, but they cannot use the same port the License Plate Recognition is using.

If you need the development document for integrating 3rd-party software, please contact VIVOTEK's technical support.

You can designate how many days the data from the data sources is retained on server in **Settings > System management > Preferences**.

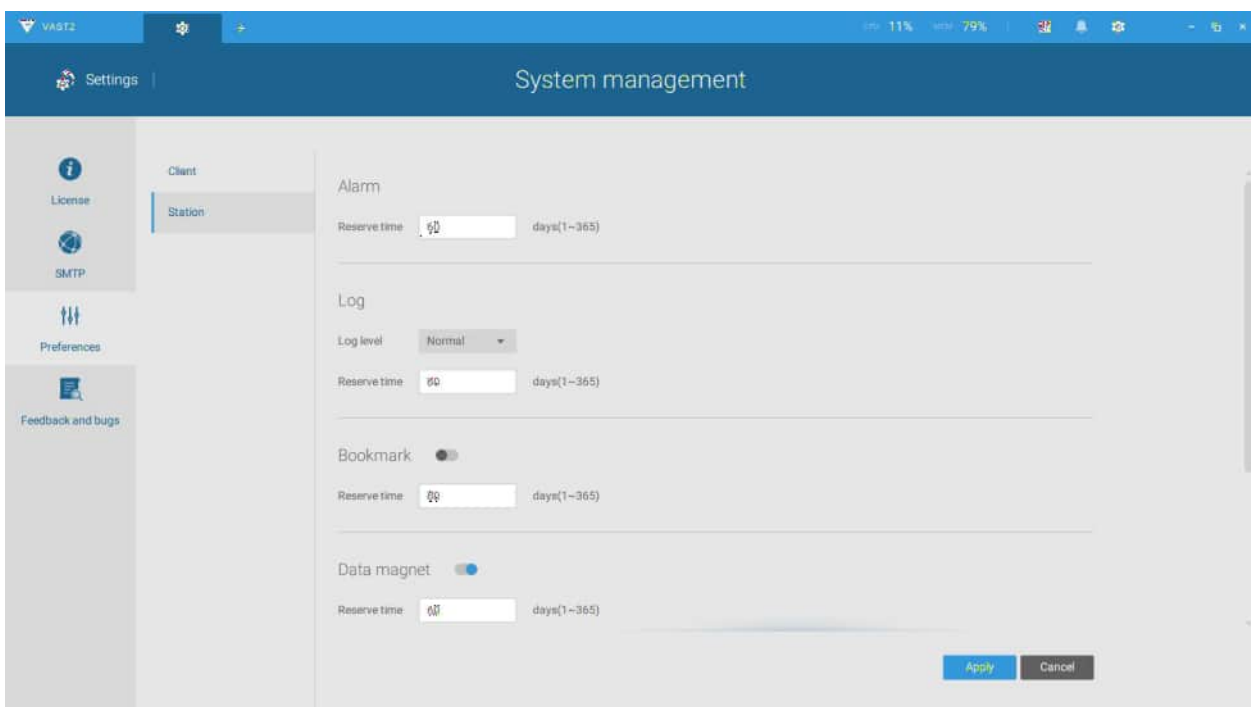

Selecting data display options:

1. On the VAST live view, right-click on screen to display Data Magnet > **Edit display data**.
If **Show data** is selected, a portion of the view cell will be used to display the captured data.

There are two different ways to show data:

1. Right-click: [Data Magnet](#) > [Show data](#).
2. Right-click: [Display information](#) > [Edit display information](#) > [Data magnet data](#).

The display options are: with or without [Data overlay on screen](#). If the overlay is not enabled, the data will display on the right pane of the view cell.

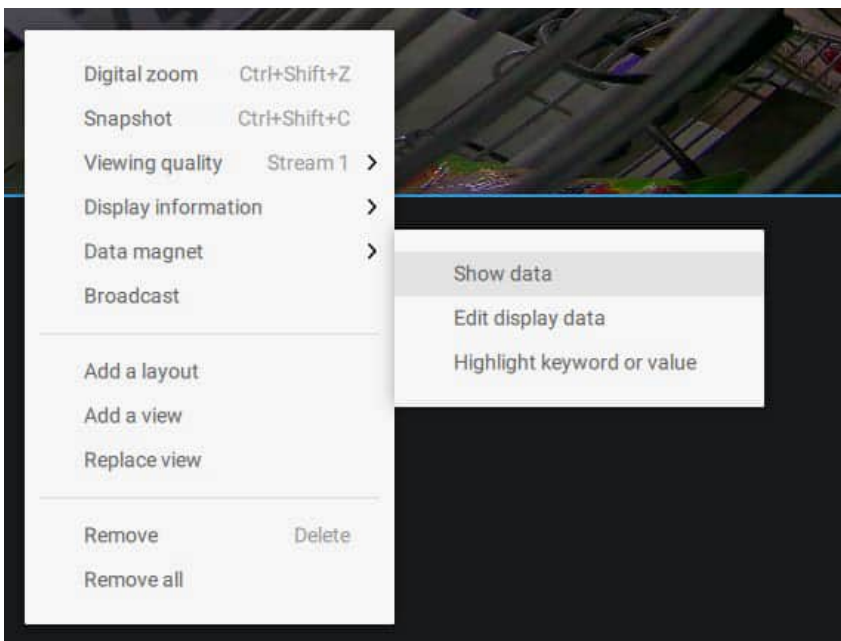

The data on the overlay can be configured to automatically disappear after a configurable time, when no new data is received (Hide data after idle _ s).

2. On the Edit pane, select all or manually select multiple display elements.

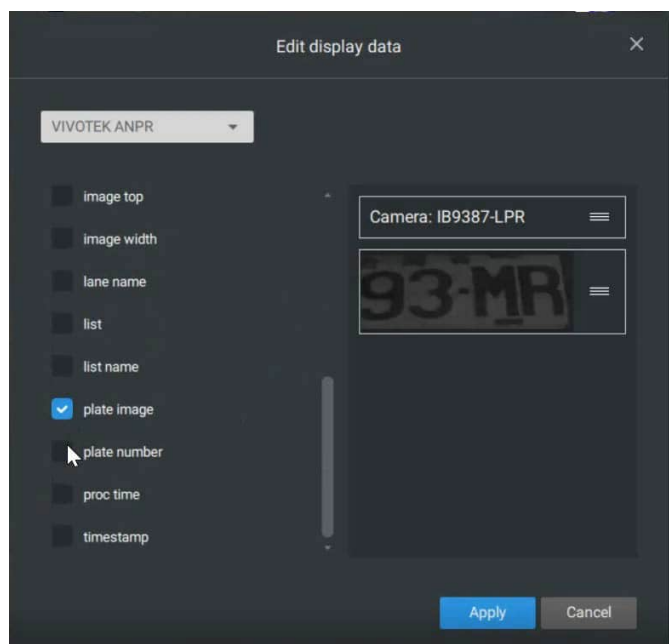
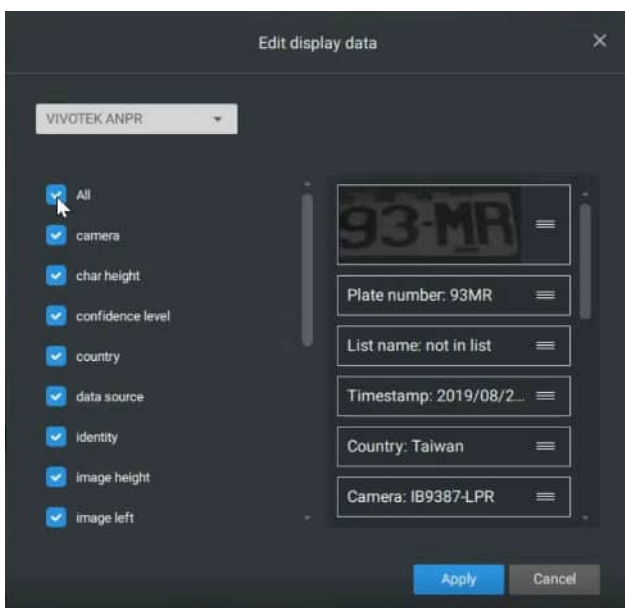

3. Click and drag individual elements to change their top-down positions on the screen. When done, click the **Apply** button.

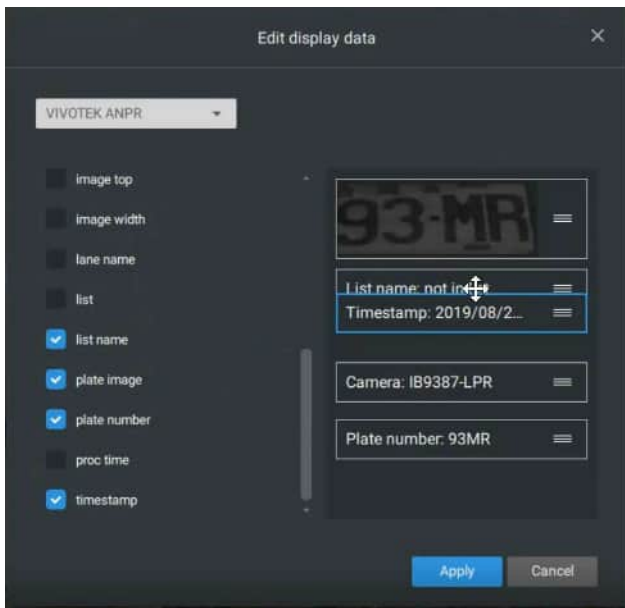

4. Click **Highlight keyword or value**. You can display information of unusual data, such as the specific numbers or characters of forbidden license plates. When such data is met, the occurrence will be highlighted in a bright yellow color.

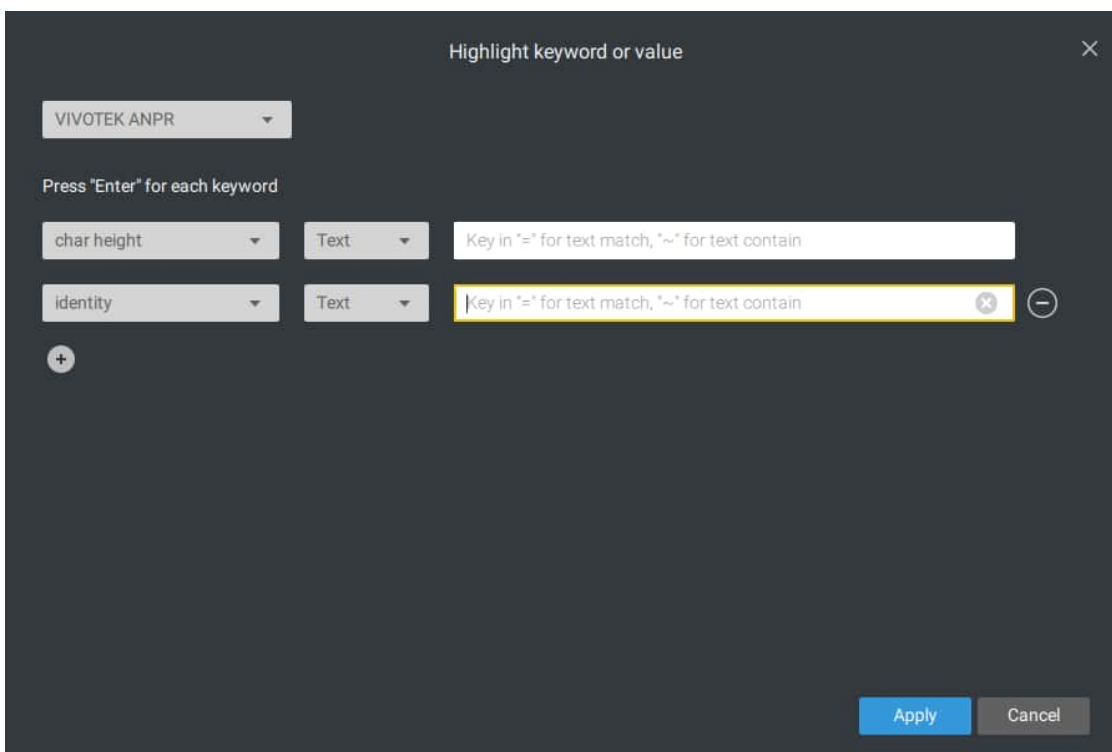

Searching for data and linked recordings:

1. On the VAST live view, click on the Applications tab.

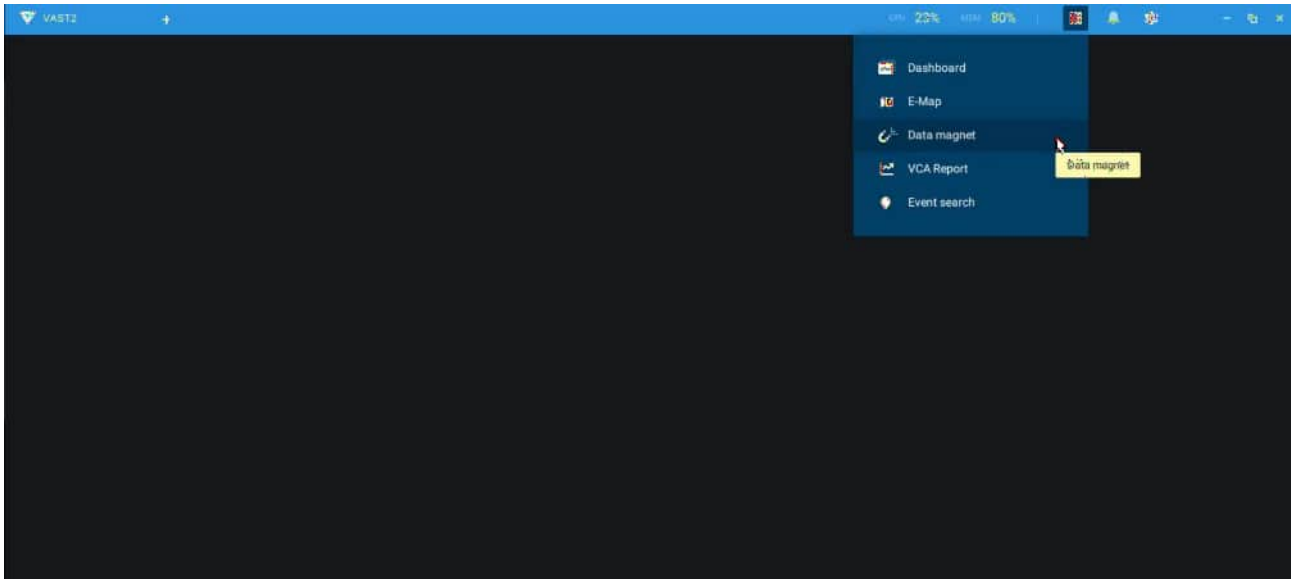

- On the Data Magnet window, select the LPR camera, and then begin with configuring the search conditions. Select the time span from the calendar. Select to display character height, country, data source, identity, image height, lane name, list name, or enter a plate number. You can select multiple filtering conditions.

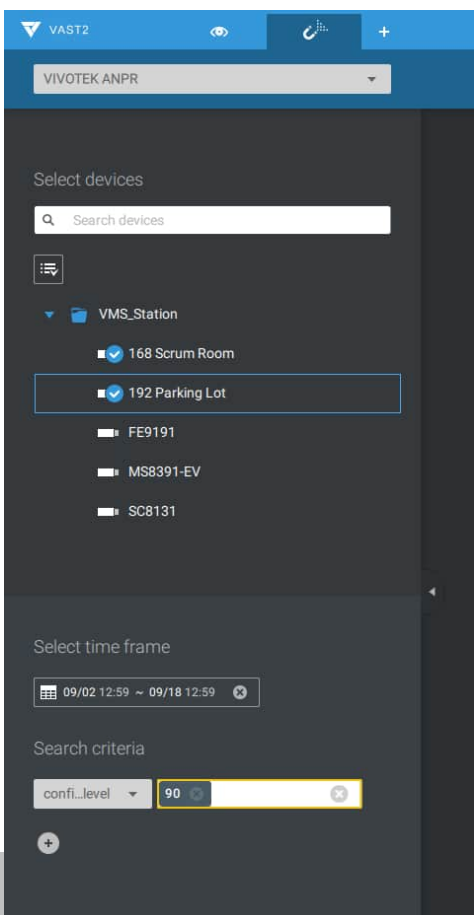
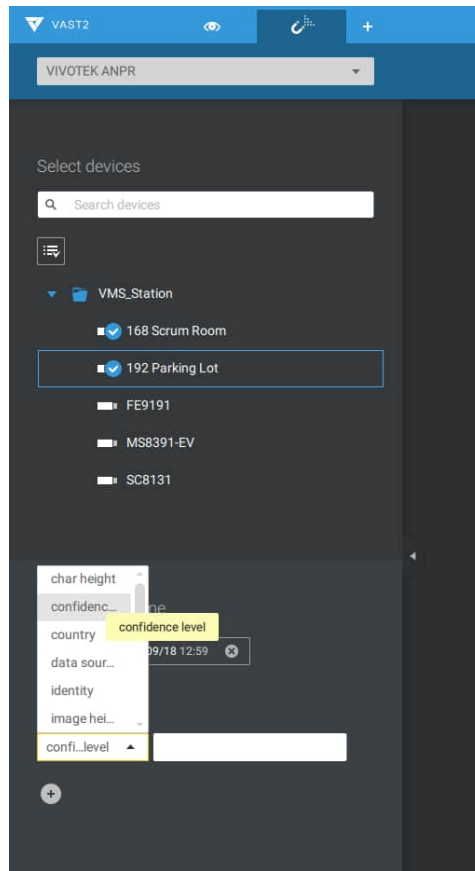
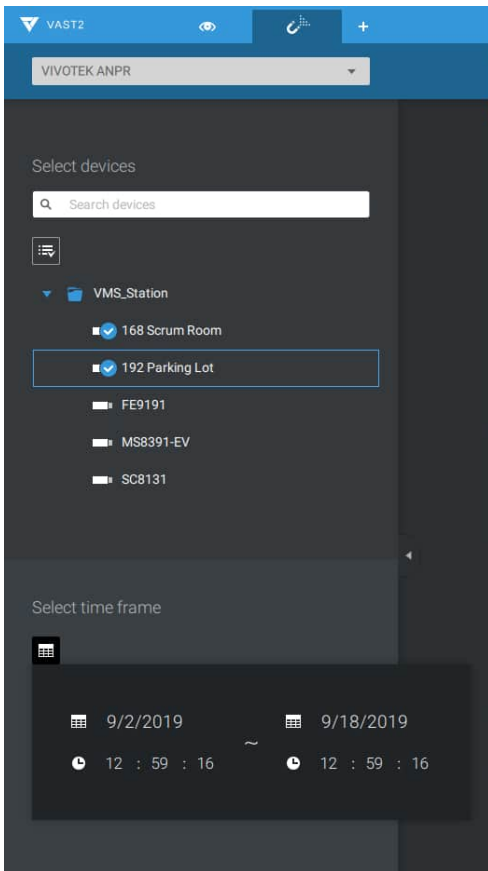

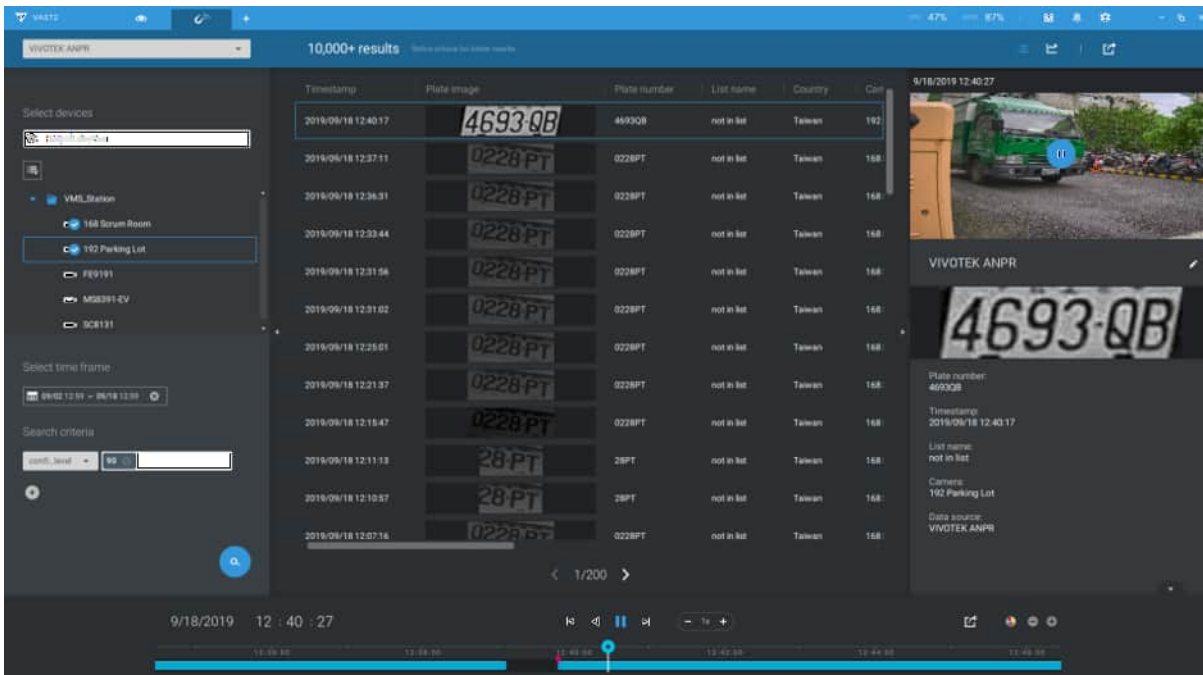

3. Click the Search button. The search results will display. Single-click to display the related video. You can also review the video in a full-screen mode.

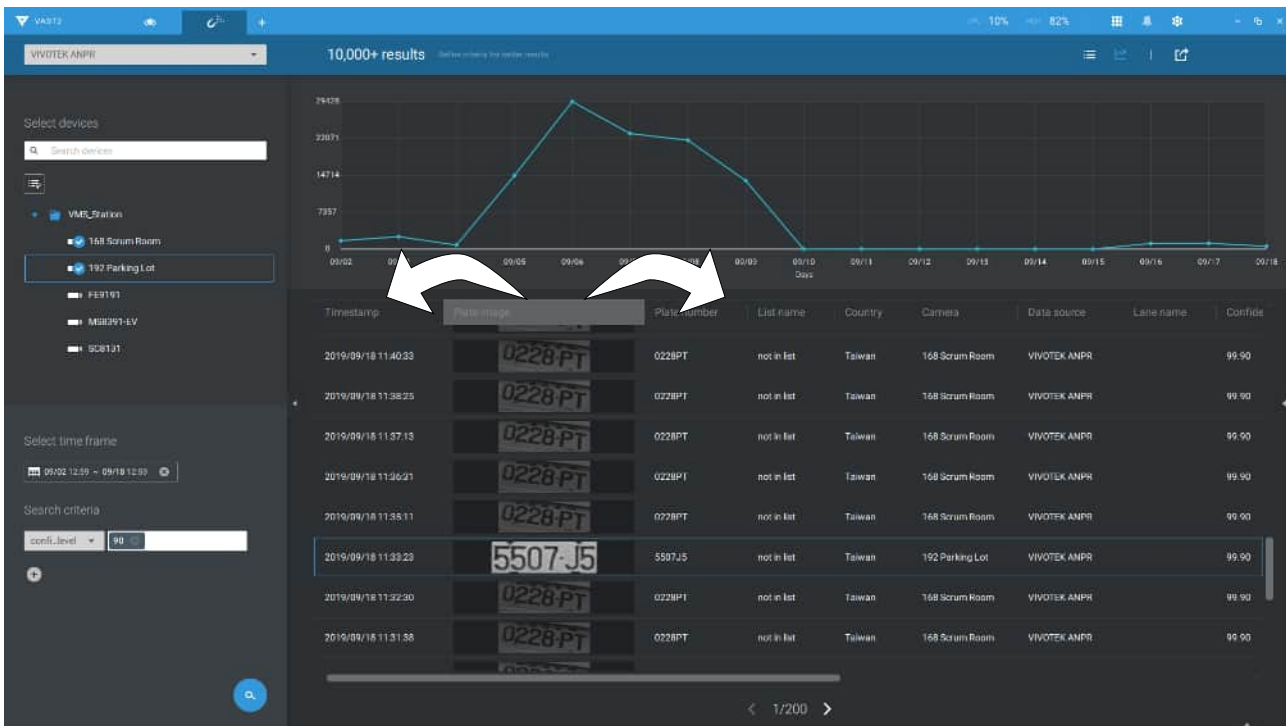

You can click and drag the display names of individual columns to switch their positions on the screen. The changes to layout are stored on the client computer. After you re-arrange the order of columns in search results, the display order will also be applied to the exported CSV file.



4. You can select and export a license plate capture using the Export function. Click on the  export button. A folder button  will display. Click on it to access the exported file.

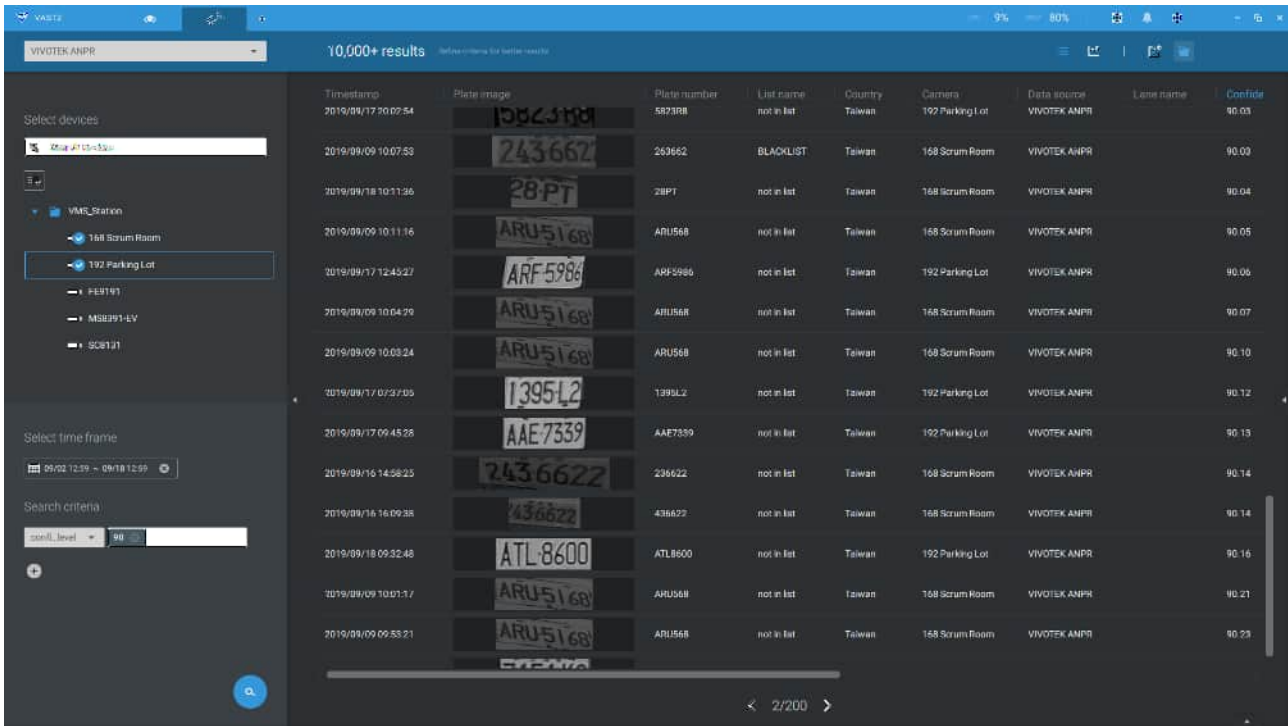

The target directory will open. Open the exported CSV file to view the search results.

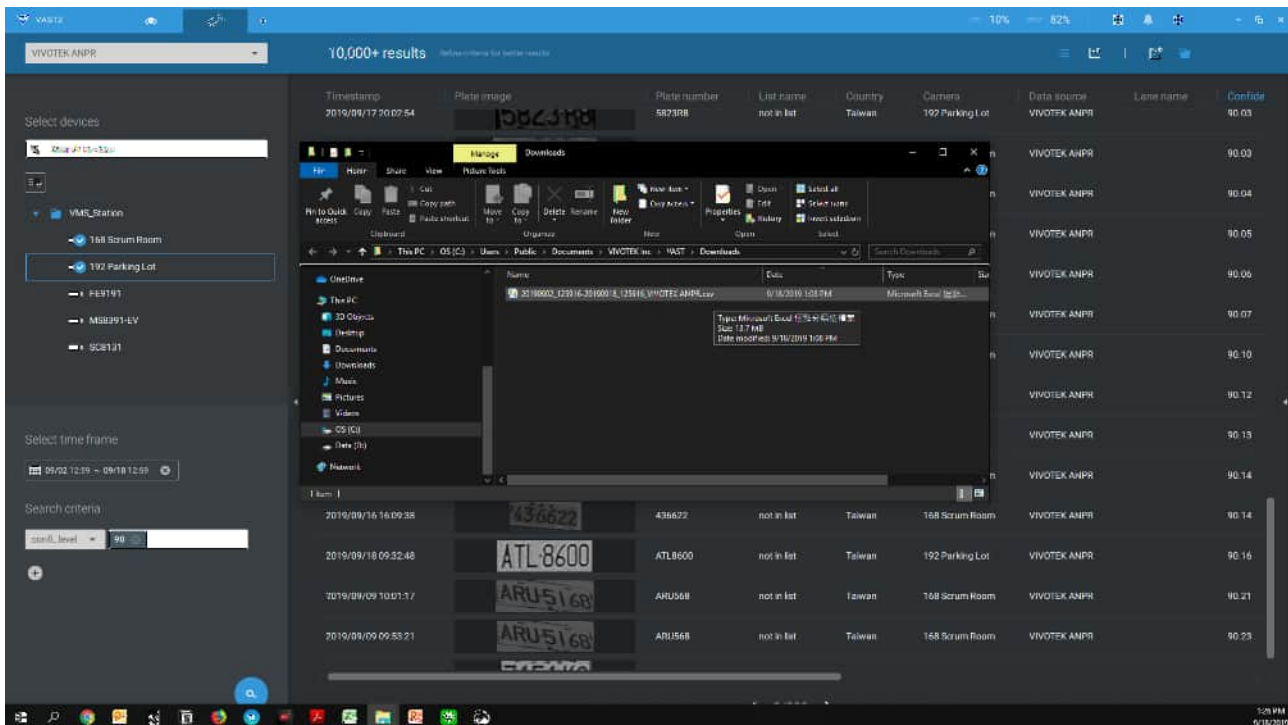

You can also open a chart view by clicking the  Chart view button. The chart view can also be exported as a png file.

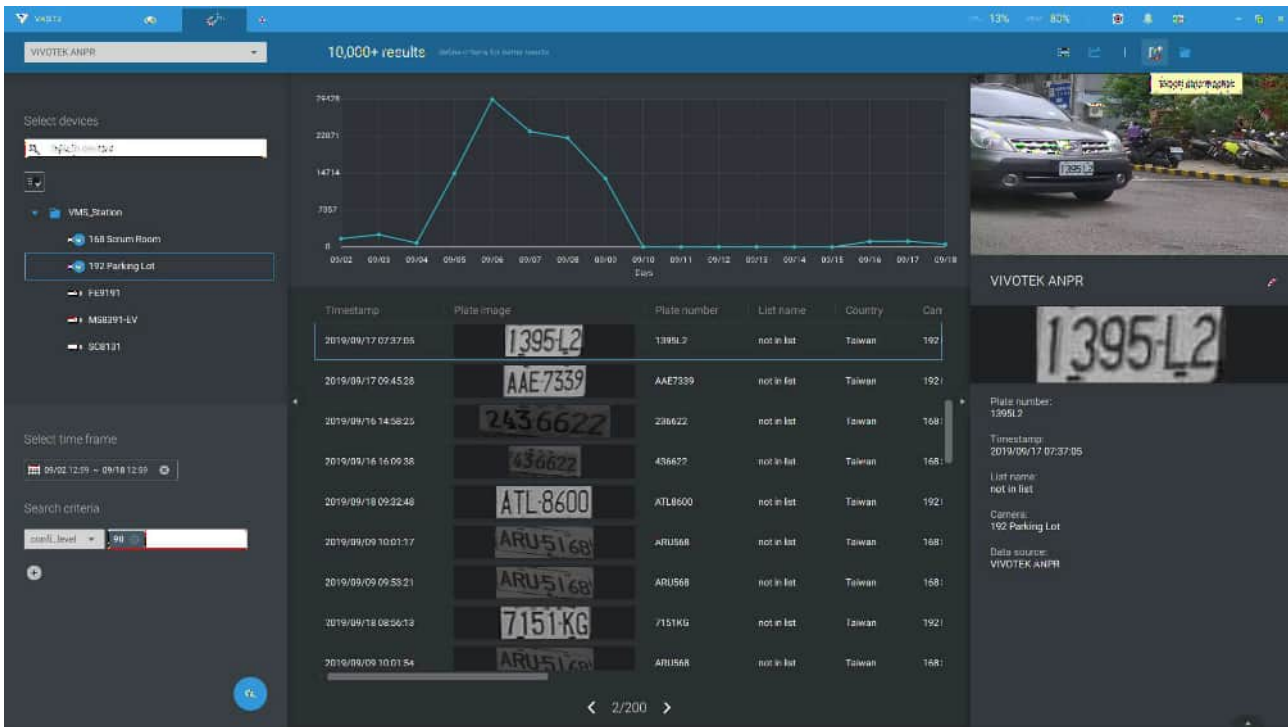

The screenshot displays the VIVOTEK ANPR software interface. At the top, it shows '10,000+ results' and a search bar containing 'ANPR'. The left sidebar includes 'Select devices' with a list of locations like '168 Scrum Room' and '192 Parking Lot', and 'Select time frame' set to '09/02 12:59 ~ 09/18 12:59'. The main area features a line chart showing detection counts over time, with a peak around 09/06. Below the chart is a table of results:

Timestamp	Plate image	Plate number	List name	Country	Car
2019/09/17 07:37:05		1395L2	not in list	Taiwan	192
2019/09/17 09:45:28		AAE7339	not in list	Taiwan	192
2019/09/16 14:58:23		24B622	not in list	Taiwan	168
2019/09/16 16:09:38		43B622	not in list	Taiwan	168
2019/09/18 09:22:48		ATL8600	not in list	Taiwan	192
2019/09/09 10:01:17		ARU568	not in list	Taiwan	168
2019/09/09 09:53:21		ARU568	not in list	Taiwan	168
2019/09/18 08:06:13		7151KG	not in list	Taiwan	192
2019/09/09 10:01:54		ARU568	not in list	Taiwan	168

On the right side, there is a video feed of a car with license plate '1395-L2' and a detailed view of the license plate. Below the video, it shows 'Plate number: 1395L2', 'Timestamp: 2019/09/17 07:37:05', 'List name: not in list', 'Camera: 192 Parking Lot', and 'Data source: VIVOTEK ANPR'. The bottom of the interface shows a pagination indicator '< 2/200 >'.

Configuring Data Magnet alarms:

1. Enter **Settings > Alarm > Add & Delete** to create a new alarm setting. Click to select External devices.

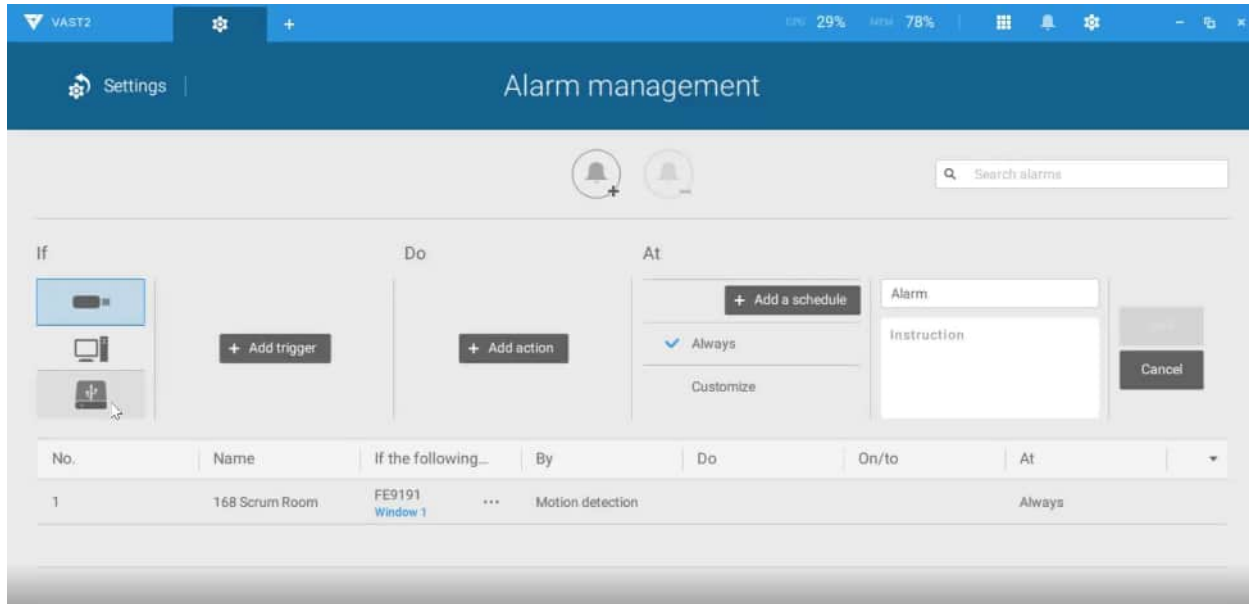

2. Select **VIVOTEK ANPR** as your triggering source. Select and create triggering conditions such as character height, image width, list, list name, country, etc. Use "=" for text matching, "~" for text containing, or approximately matching specific characters, and also ">," "<," ">=," "<=" for numbers larger or smaller than a preset value.

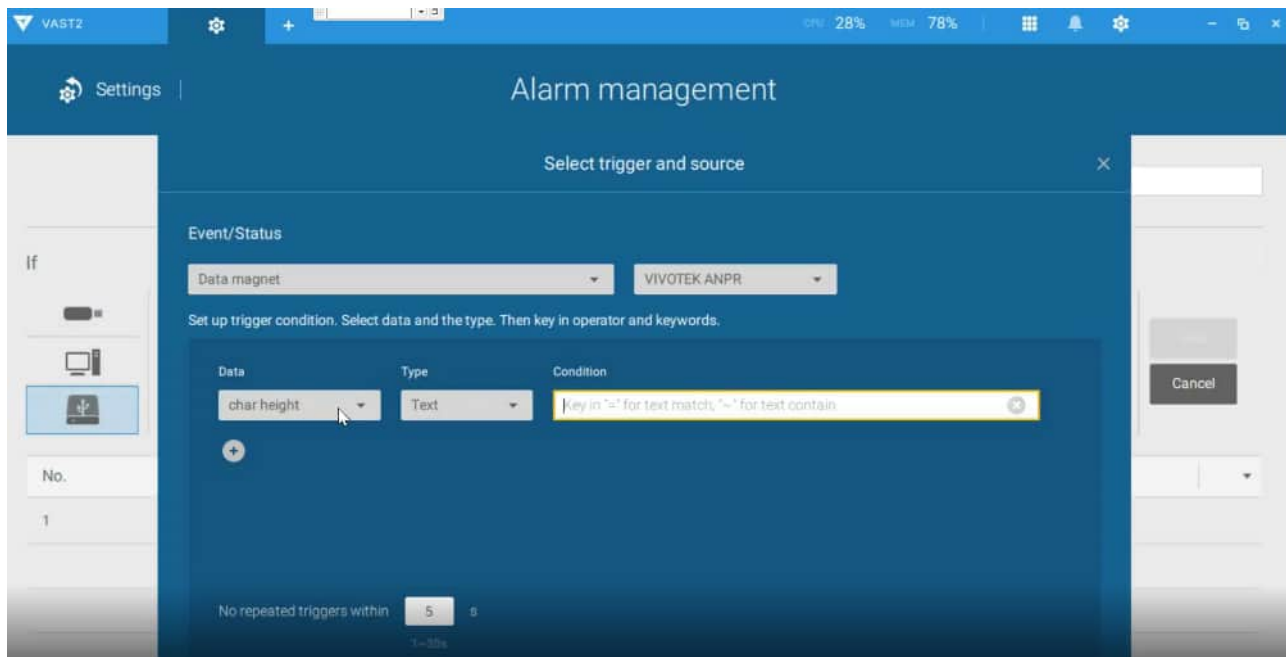

3. Continue to configure your triggering conditions. You can create multiple conditions.

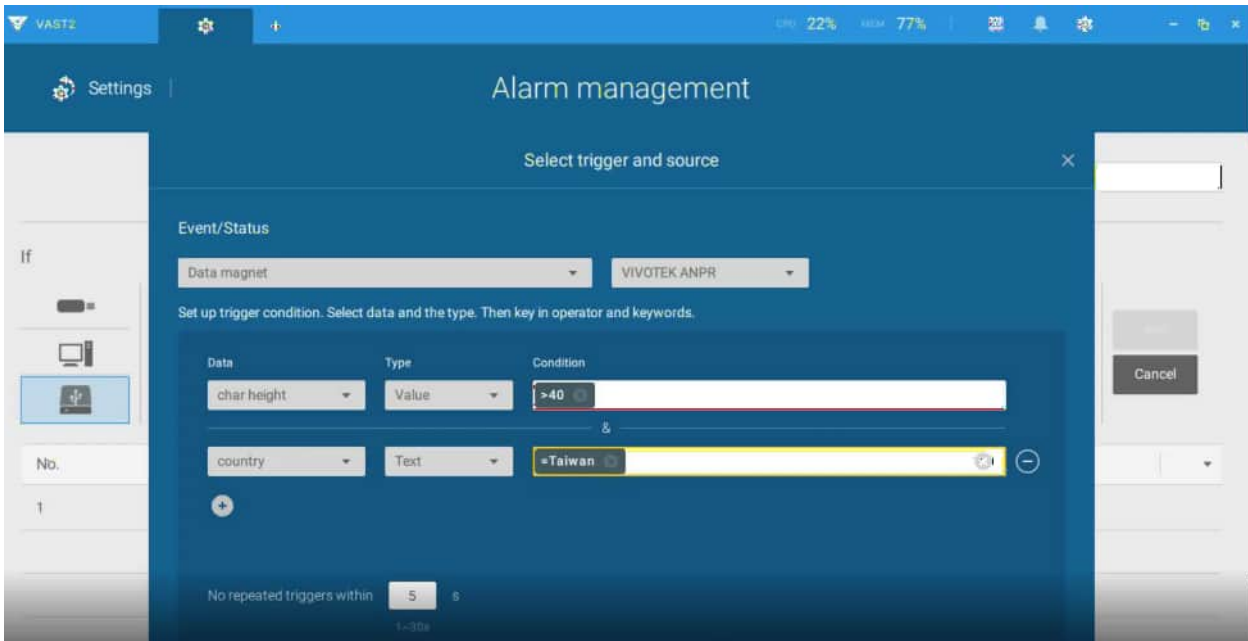

4. Continue to configure the actions for a triggered alarm, such as sending live streaming.

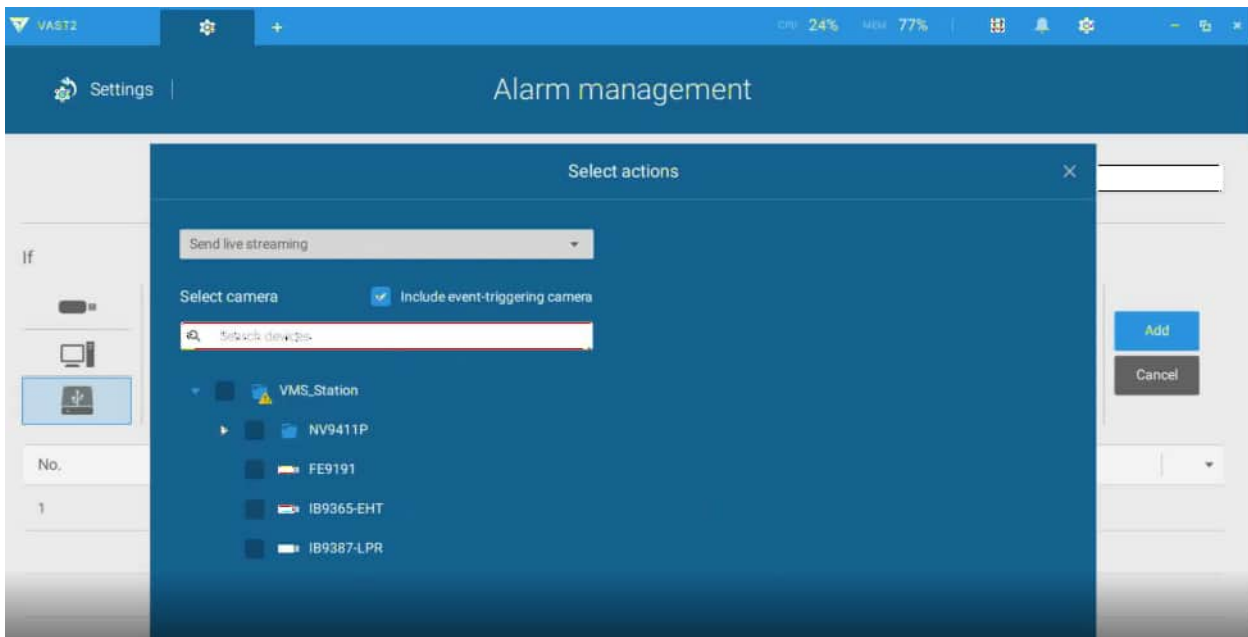

5. When done, enter a name for the alarm and click the **Add** button to complete.

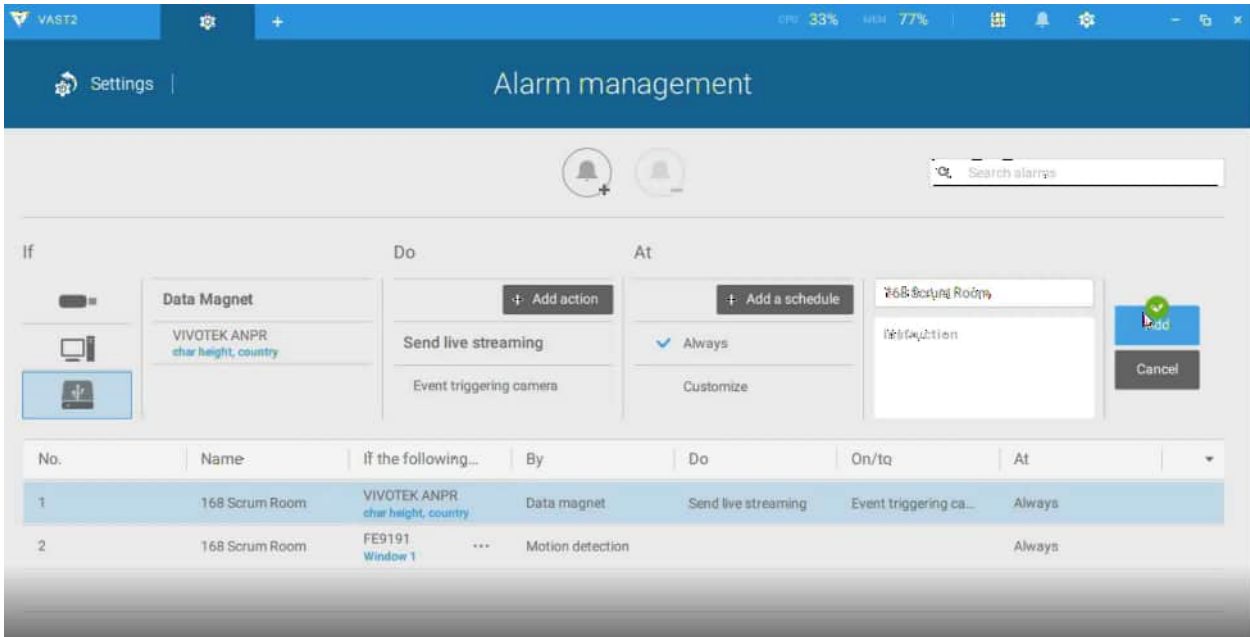

6. You can now receive alarm notifications triggered by license plate recognition via the Data Magnet.

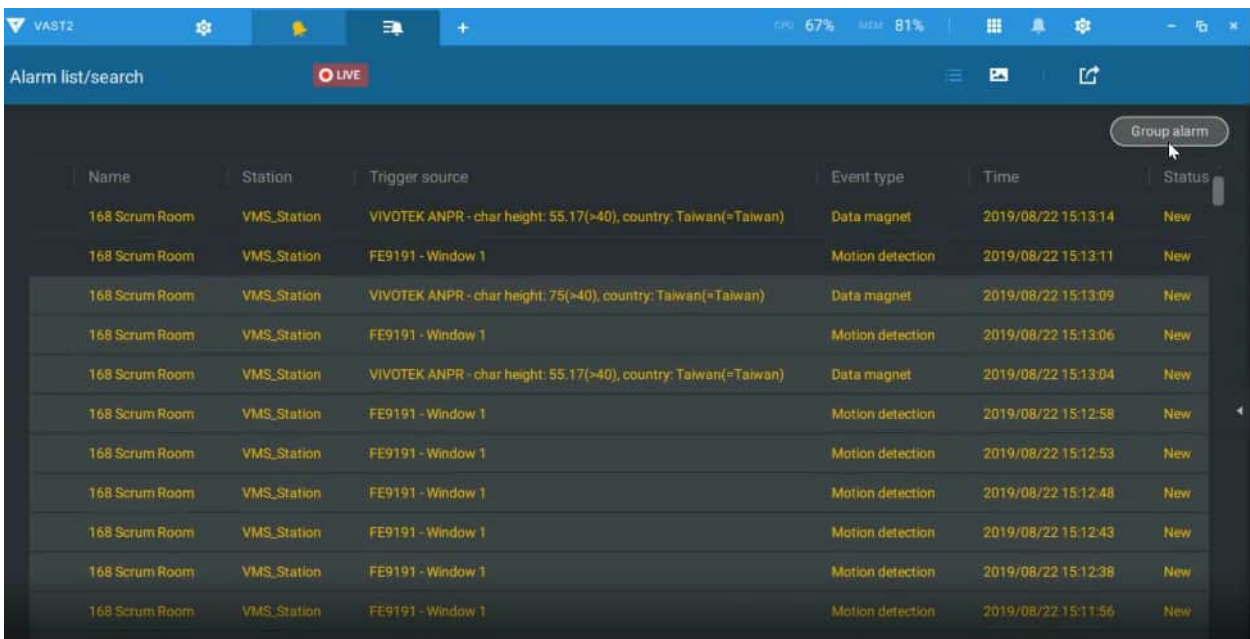

Note that if you select "Include event-triggering camera" during the alarm configuration stage, the camera delivering the data source will be automatically selected.

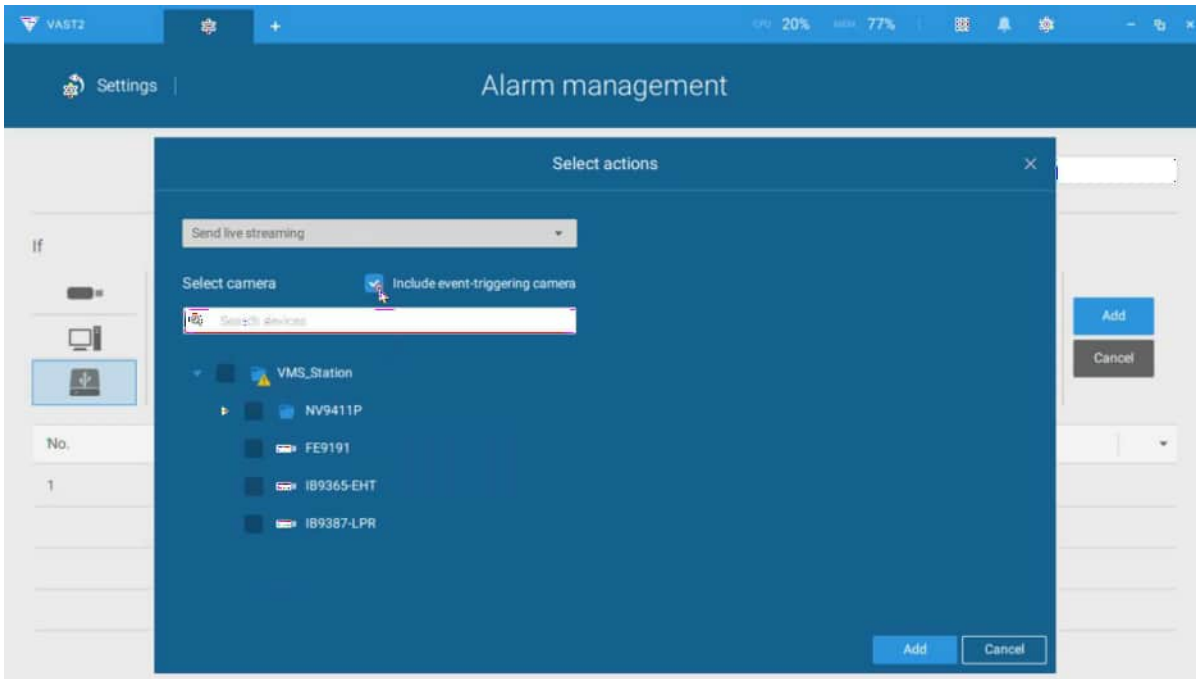

Configuring Data Source macro via Send email and Send HTTP requests:

In **Settings > Alarm > Add & Delete**, Email and HTTP requests can be used to send data source macro to receivers. Use "
" as the line break command. Note that an SMTP server should have been configured before the Email settings in Alarm.



You can specify multiple lines of information in your alarm notification message.

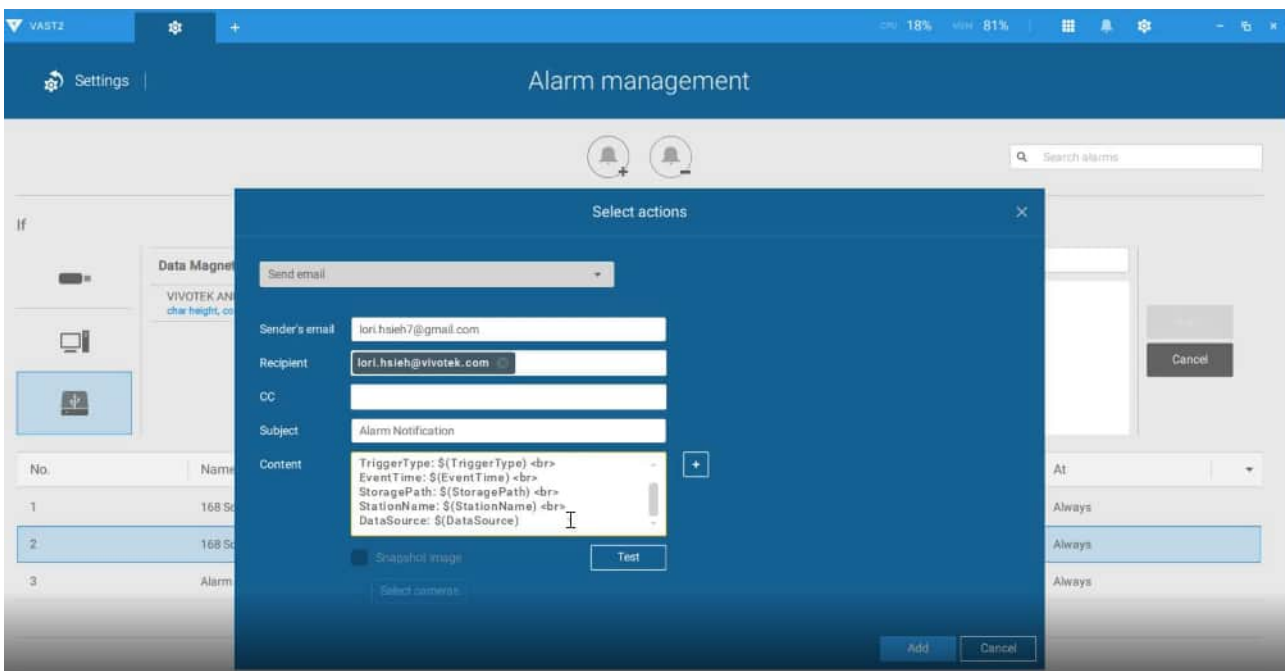

Appendix F: Enable Smart Tracking for Speed Dome Cameras

The Smart tracking function is available on speed dome cameras, such as SD9374-EHLX. The Smart tracking feature is separately configured on the camera side. Please refer to [Smart Tracking User Guide](#) for configuration details.

To display Smart tracking on VAST,

1. Enter Settings > Devices > Cameras.
2. Select the speed dome camera that supports this feature.
3. Select PTZ Settings, and the Track mode menu. Select **Smart tracking** as the tracking display mode. A hyperlink is provided for the Smart tracking configuration page.

It is recommended to always enable "[Enable track if the camera idles for xx seconds.](#)" Manual PTZ control always has a higher priority and will interrupt tracking.

4. Click the **Apply** button.

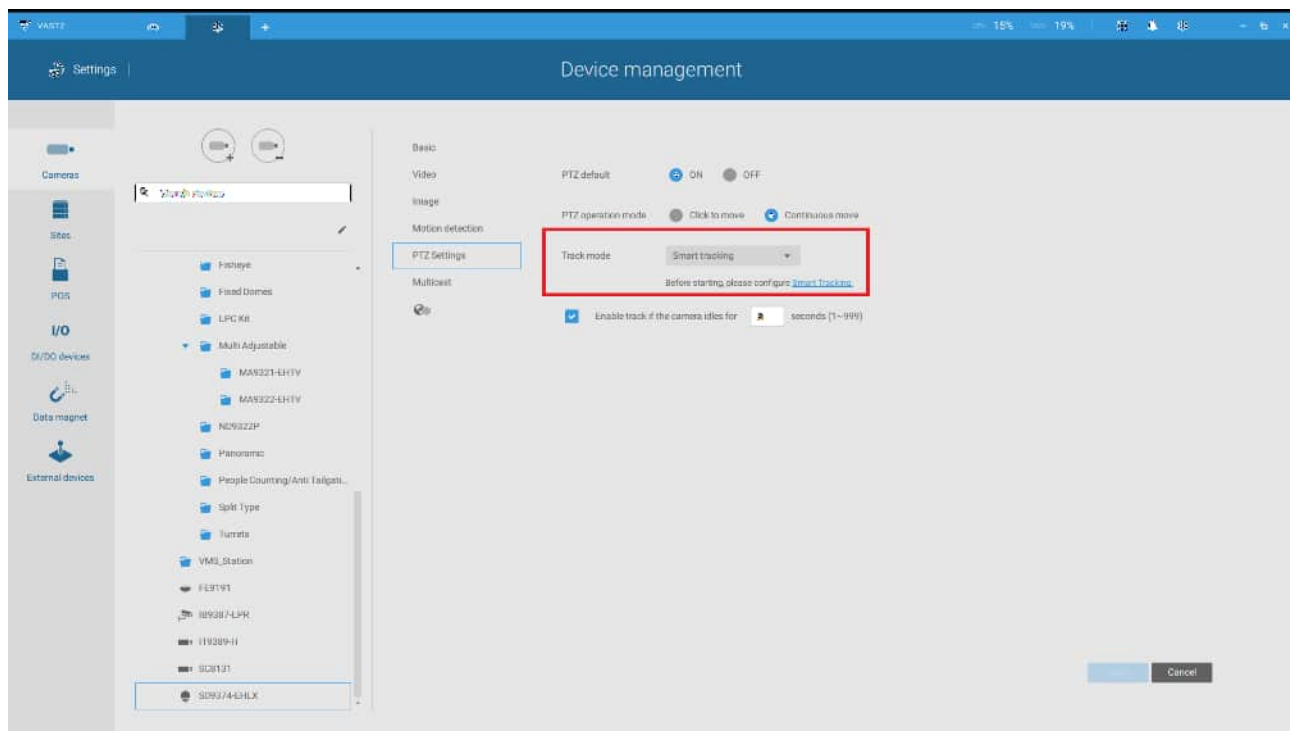

5. On the view cell of the speed dome, click PTZ settings, and then click the Tracking button.

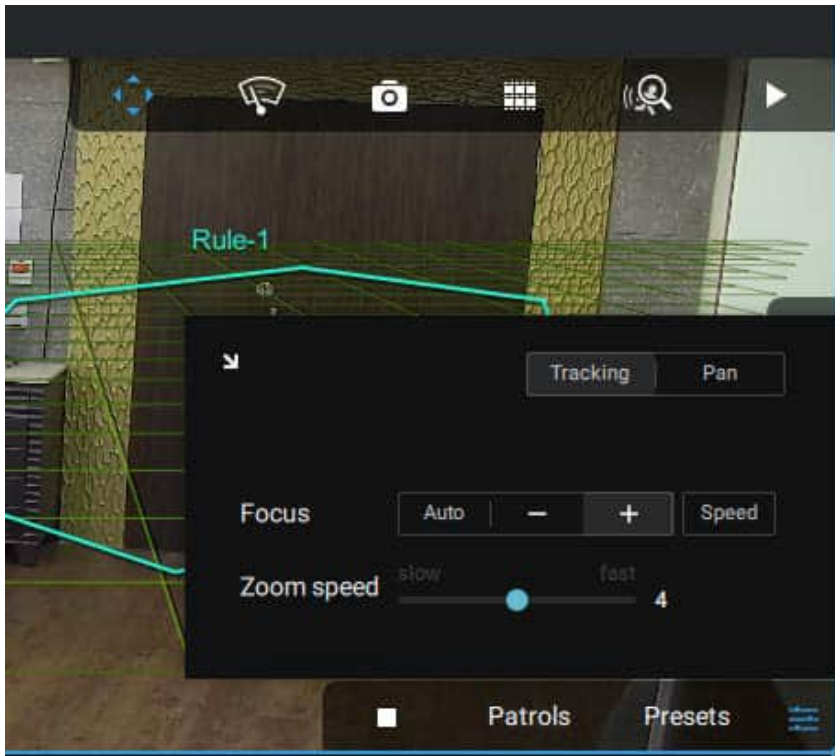

Appendix G Database Merge Function

The Database Merge function applies in the following scenario:

1. A VAST server A failed or was intentionally depleted. The precondition is that the disk drives containing the recordings remain intact. Server B must also have the configuration profile of the Server A.

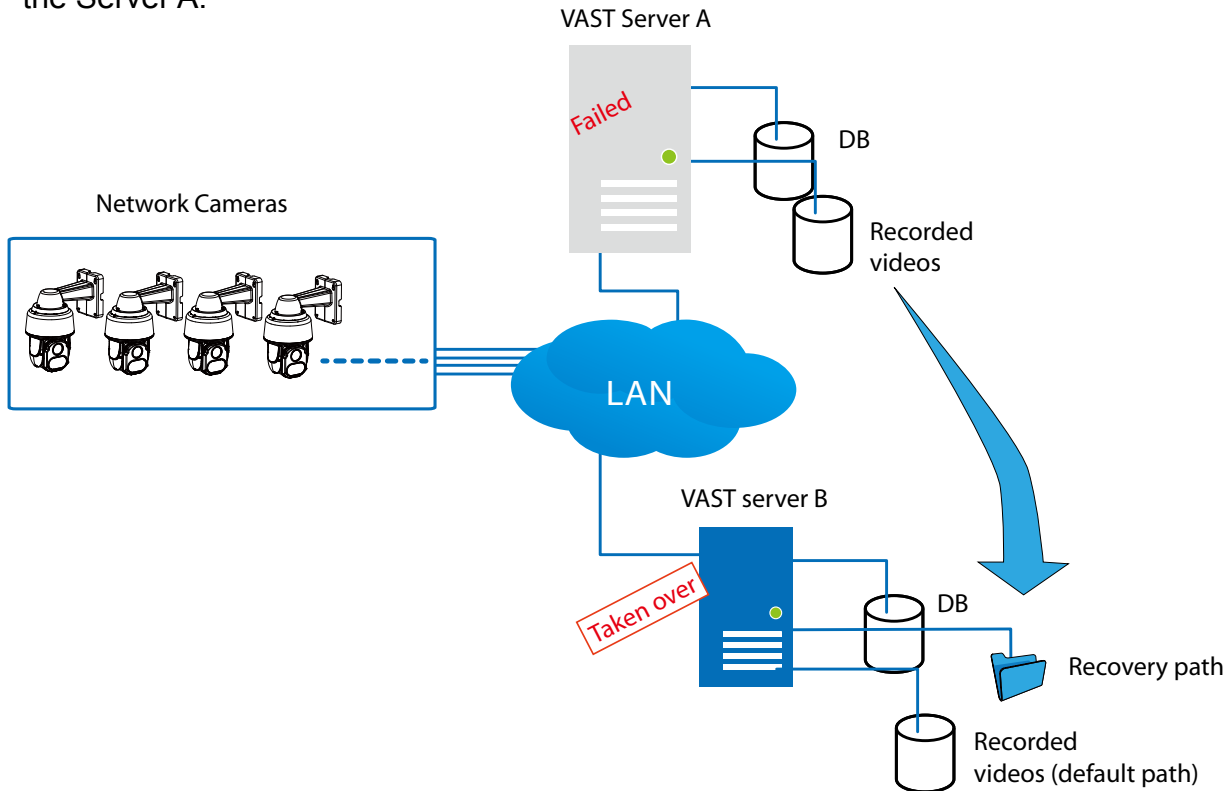

2. The VAST server B is used to continue video recording. The previous recordings on server A can be retrieved by attaching the hard disk(s) to server B or manually copying to a storage device on server B. You can then designate the location of these files as the "Recovery path" from server B. An administrator can then use the VAST software to access the past recordings.



- It is **IMPORTANT** to move or copy the entire storage group folder, e.g., `D:/recording/2016-06-17/1-FE9181-H...`, which is a root directory configured by VAST server as the recording folder. The default recording folder contains file folder structure, video files, and database metadata. If you copy the video files only, the database data will not be synchronized, and you will not be able to access the recordings.
- The video streams received from cameras will not be recorded on to the Recovery path folder. It is designed to maintain previous recordings. The Recovery path folder becomes static.

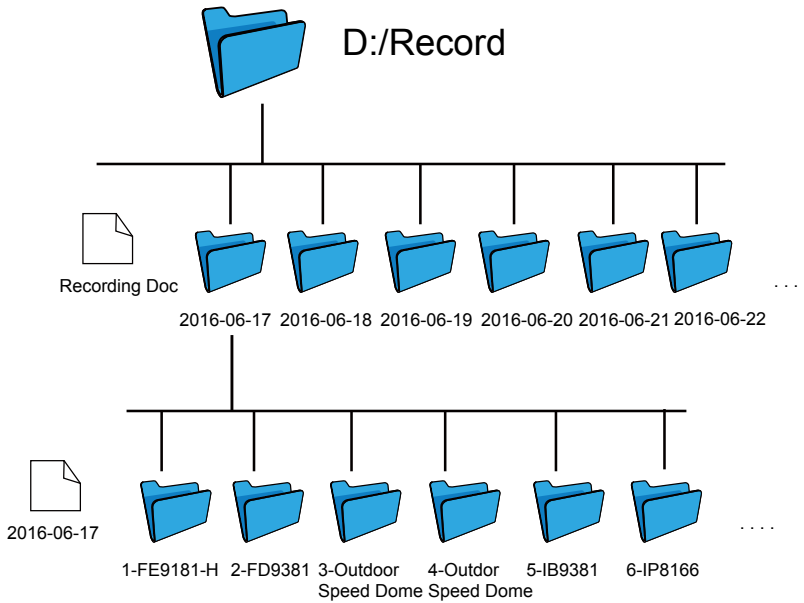

- It is also a good habit to export and preserve your VAST system configuration to prevent losses in the event of system failure. In case you want to migrate or upgrade your VAST server, you can use the Import-Export utility to duplicate your VAST configuration to another server. Copy the configuration file and import the configuration from another VAST server.

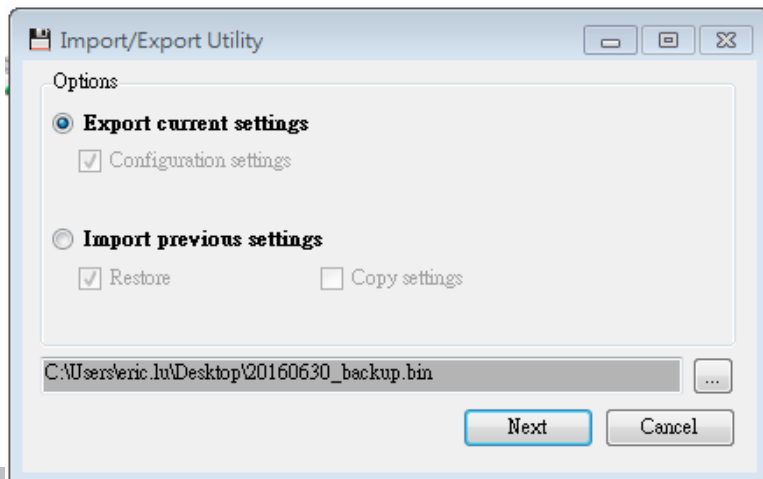
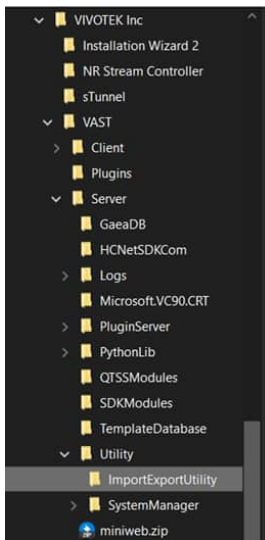

When the file folder is ready for server B, designate the location of recovered files from another VAST server, go to Settings > Recording management > Recording options.

Select the recording folder that contains the recordings from the counterpart VAST server. Select the **Restore recordings from this path** checkbox and click **Add**.

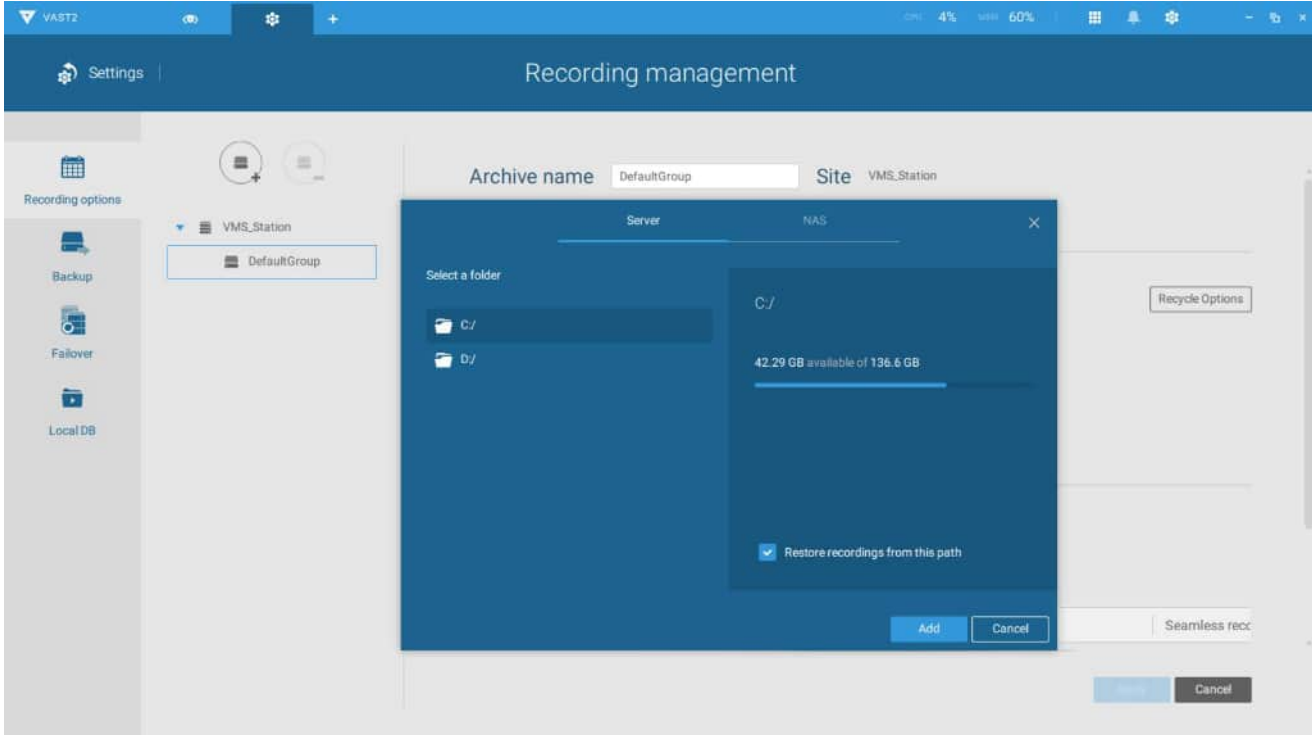

The Local Database you incorporated will be listed on the device tree, which is separated from your current deployment. There are two different scenarios"

1. Using Recovery path:

Server B incorporated Server A configuration file, selected Recording options and the "Restore recordings from this path" option. The device tree will look similar to the original VAST server A configuration.

2. Using Local DB:

A Local DB sub-folder will appear on the device tree. Click to select the cameras in the sub-folder to access the past recordings. The recordings in the Local DB is only accessible from the computer which has a copy of the Local DB.

[For system backup options, refer to page 284.](#)