

WISENET

NETWORK CAMERA

Quick Guide

XNB-6002



Important

Please check 'Manuals' from our website, before connecting to the Supply,
<https://www.hanwha-security.com/en/data-center/download-data/>

Warranty

Please check "Product warranty information" from our website.
<https://www.hanwha-security.com/support/warranty/>

We recommend to use the officially compatible VMS version or latest Hanwha NVR version when integrating with VMS or Hanwha NVR.



Hanwha Techwin cares for the environment at all product manufacturing stages, and is taking measures to provide customers with more environmentally friendly products.

The Eco mark represents Hanwha Techwin's devotion to creating environmentally friendly products, and indicates that the product satisfies the EU RoHS Directive.



Correct Disposal of This Product (Waste Electrical & Electronic Equipment)

(Applicable in the European Union and other European countries with separate collection systems)

This marking on the product, accessories or literature indicates that the product and its electronic accessories (e.g. charger, headset, USB cable) should not be disposed of with other household waste at the end of their working life. To prevent possible harm to the environment or human health from uncontrolled waste disposal, please separate these items from other types of waste and recycle them responsibly to promote the sustainable reuse of material resources.

Household users should contact either the retailer where they purchased this product, or their local government office, for details of where and how they can take these items for environmentally safe recycling.

Business users should contact their supplier and check the terms and conditions of the purchase contract. This product and its electronic accessories should not be mixed with other commercial wastes for disposal.



Correct disposal of batteries in this product

(Applicable in the European Union and other European countries with separate battery return systems.)

This marking on the battery, manual or packaging indicates that the batteries in this product should not be disposed of with other household waste at the end of their working life. Where marked, the chemical symbols Hg, Cd or Pb indicate that the battery contains mercury, cadmium or lead above the reference levels in EC Directive 2006/66. If batteries are not properly disposed of, these substances can cause harm to human health or the environment.

To protect natural resources and to promote material reuse, please separate batteries from other types of waste and recycle them through your local, free battery return system.

SAFETY INFORMATION



COMPONENT

As for each sales country, accessories are not the same.

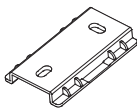
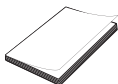

- Not Included : SD CARD

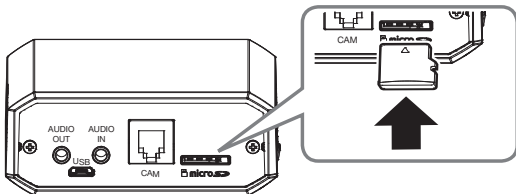

INSTALLATION

1

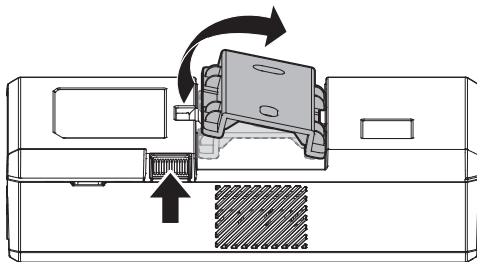

2

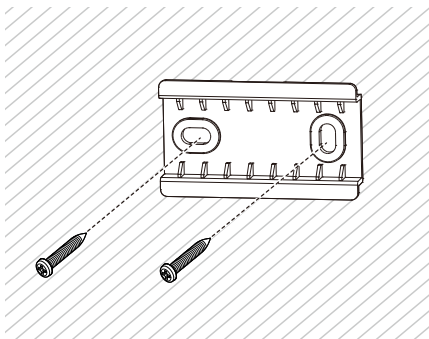

5

INSTALLATION

3

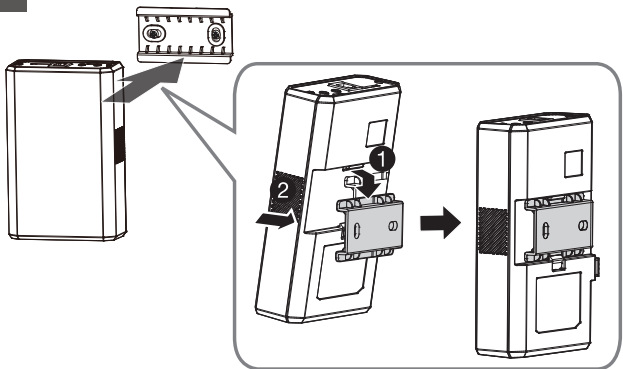

4

- Not included: Lens Module

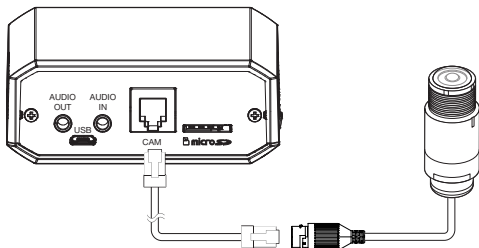

- Turn off the camera power when connect or remove lens module.

INSTALLATION

5

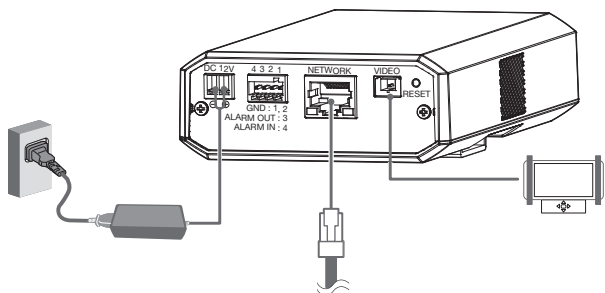

6

- Not Included : Wi-Fi dongle, OTG adapter

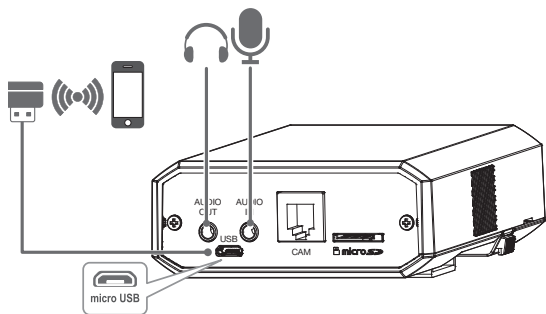

INSTALLATION

7



8



PASSWORD SETTING

When you access the product for the first time, you must register the login password.



- For a new password with 8 to 9 digits, you must use at least 3 of the following: uppercase/lowercase letters, numbers and special characters. For a password with 10 to 15 digits, you must use at least 2 types of those mentioned.
 - Special characters that are allowed. :
~!@#\$%^&*()_-+={ }[]\;:'" <>.,?/
- Space is not allowed for password.
- For higher security, you are not recommended to repeat the same characters or consecutive keyboard inputs for your passwords.
- If you lost your password, you can press the **[RESET]** button to initialize the product. So, don't lose your password by using a memo pad or memorizing it.

LOGIN

Whenever you access the camera, the login window appears.

Enter the User ID and password to access the camera.

- 1 Enter **"admin"** in the <User Name> input box.
- 2 Enter the password in the <Password> input field.
- 3 Click **[Sign in]**.

CONNECTING TO WiFi

Camera setting

- 1 Connect OTG adapter (5-pin) and Wi-Fi dongle to the micro USB terminal.

Smartphone setting

- 1 Install the Wisenet Installation application.
- 2 Select the camera SSID after turning on the WiFi.
- 3 Run the Wisenet Installation application.
- 4 When you log in to the camera, the video will be connected.
 - The video will be played without being logged in during the initial connection.
- 5 You can adjust angle of view while watching the video through smartphone.



Подлежит использованию по назначению
в нормальных условиях
Срок службы : 7 лет.

Türkiye Distribütörü

EDS Elektronik Destek Sanayi ve Ticaret Ltd. Şti.

Meclis Mah. Teraziler Cad. Hayran Sk. (Eskisi Kılıç Sk.) No: 4 Sancaktepe / İstanbul / Türkiye

Tel +90.216.313.25.15 Faks +90.216.528.45.98

Koyuncu Elektronik Bilgi İşlem Sistemleri San. ve Dış. Tic. A.Ş.

Emek Mah. Ordu Cad. No:18 Sancaktepe / İstanbul / Türkiye

Tel +90.216.528.88.88 Faks +90.216.313.18.18

NFS Teknoloji ve Otomasyon Sistemleri San. Ve Tic. Ltd. Şti.

Cumhuriyet Mah Şair M.Akif Ersoy Sk. No:36 Üsküdar / İstanbul / Türkiye

Tel +90.216.505.82.28 Faks +90.216.505.82.29

Sensonet Teknoloji Elekt. ve Biliş. Hiz. San. ve Tic. Ltd. Şti.

Ramazanoğlu Mah. Transtek Cad. No: 2 Pendik / İstanbul / Türkiye

Tel +90.216.999.49.49 Faks +90.212.381.61.02

ENTES ELEKTRONİK CİHAZLAR İMALAT VE TİC. A.Ş.

Dudullu Org.San.Bölg. 1. Cad. No:23 34776 Ümraniye - İstanbul / Türkiye

Tel +90.216.313.01.10 Faks +90.216.314.16.15

Cihazın Ticaret Bakanlığınca önerilen ortalama ömrü

Cihazın EEE yönetmeliklerine uygun olduğuna benzer beyan

한화테크윈(주)

경기도 성남시 분당구 판교로 319번길 6 (삼평동 701)

영 업 TEL 070-7147-8771~9 A/S 및 기술문의 1588-5772

부산영업소 TEL 051-796-3216

대구영업소 TEL 053-742-3098

광주영업소 TEL 062-941-9559

대전영업소 TEL 042-489-9840

www.hanwha-security.com

Head Office

6, Pangyo-ro 319 beon-gil, Bundang-gu, Seongnam-si,

Gyeonggi-do, 463-400 Rep. of KOREA

Tel : +82.70.7147.8753 Fax : +82.31.8018.3740

www.hanwha-security.com

Hanwha Techwin America

500 Frank W. Burr Blvd. Suite 43 Teaneck, NJ 07666

Toll Free : +1.877.213.1222 Direct : +1.201.325.6920

Fax : +1.201.373.0124

www.hanwhasecurity.com

Hanwha Techwin Europe

Heriot House, Heriot Road, Chertsey, Surrey, KT16 9DT, United Kingdom

Tel : +44.1372.235663 Fax : +44.1932.57.8101

www.hanwha-security.eu

Hanwha Techwin Middle East FZE

JAFZA View 18, 20th floor, office 2001, 2002, 2003, Downtown Jebel Ali,

Dubai, United Arab Emirates

www.hanwha-security.com

Hanwha Techwin Vietnam Hanoi Office

28th Floor, Handico Building, Pham Hung Street, Me Tri ward, Nam Tu Liem District, Hanoi City, Vietnam

Tel : +84.91.982.40.88

www.hanwha-security.com
